

US00D882998S

(12) **United States Design Patent** (10) **Patent No.:** **US D882,998 S**  
**Tippmann** (45) **Date of Patent:** **\*\* May 5, 2020**

(54) **DESKTOP WITH CONCEALABLE WORKSPACE**

D648,584 S \* 11/2011 Ellis ..... D6/667  
D715,080 S \* 10/2014 Thornley ..... D6/707.19  
2017/0156489 A1\* 6/2017 Tippmann ..... A47B 17/04

(71) Applicant: **Joseph Daniel Tippmann**, Fort Wayne, IN (US)

\* cited by examiner

(72) Inventor: **Joseph Daniel Tippmann**, Fort Wayne, IN (US)

*Primary Examiner* — Mary Ann Calabrese  
(74) *Attorney, Agent, or Firm* — Dunlap Bennett & Ludwig PLLC; Brendan E. Squire

(\*\*) Term: **15 Years**

(21) Appl. No.: **29/633,615**

(22) Filed: **Jan. 15, 2018**

(57) **CLAIM**

The ornamental design for a desktop with concealable workspace, as shown and described.

**Related U.S. Application Data**

**DESCRIPTION**

(63) Continuation-in-part of application No. 15/371,918, filed on Dec. 7, 2016, now abandoned.

(51) **LOC (12) Cl.** ..... **06-06**

(52) **U.S. Cl.**  
USPC ..... **D6/707.19**

(58) **Field of Classification Search**  
USPC ..... D6/641, 644, 655, 655.17, 18, 685, 686, D6/691, 691.1–691.19, 707, 707.19  
CPC .... A47B 1/00; A47B 1/02; A47B 1/05; A47B 1/10; A47B 5/00; A47B 7/00; A47B 13/00; A47B 13/08; A47B 13/081; A47B 13/088; A47B 13/10; A47B 13/12; A47B 17/00; A47B 17/036; A47B 17/04; A47B 17/06; A47B 21/00; A47B 2200/0001; A47B 2200/0066

See application file for complete search history.

FIG. 1 is a top front perspective view of a desktop with concealable workspace showing my new design in a closed condition;  
FIG. 2 is a lower front perspective view thereof;  
FIG. 3 is a top plan view thereof;  
FIG. 4 is a bottom plan view thereof;  
FIG. 5 is a front elevation view thereof, the rear elevation view being a mirror image thereof;  
FIG. 6 is a left side elevation view thereof; the right side elevation view being a mirror image thereof;  
FIG. 7 is a top front perspective view of the desktop with concealable workspace in an open condition;  
FIG. 8 is a lower front perspective view thereof;  
FIG. 9 is a front elevation view thereof;  
FIG. 10 is a rear elevation view thereof;  
FIG. 11 is a top plan view thereof;  
FIG. 12 is a bottom plan view thereof;  
FIG. 13 is a left side elevation view thereof; the right side elevation view being a mirror image thereof;  
FIG. 14 is an exploded front perspective view thereof; and, FIG. 15 is an exploded rear perspective view thereof.

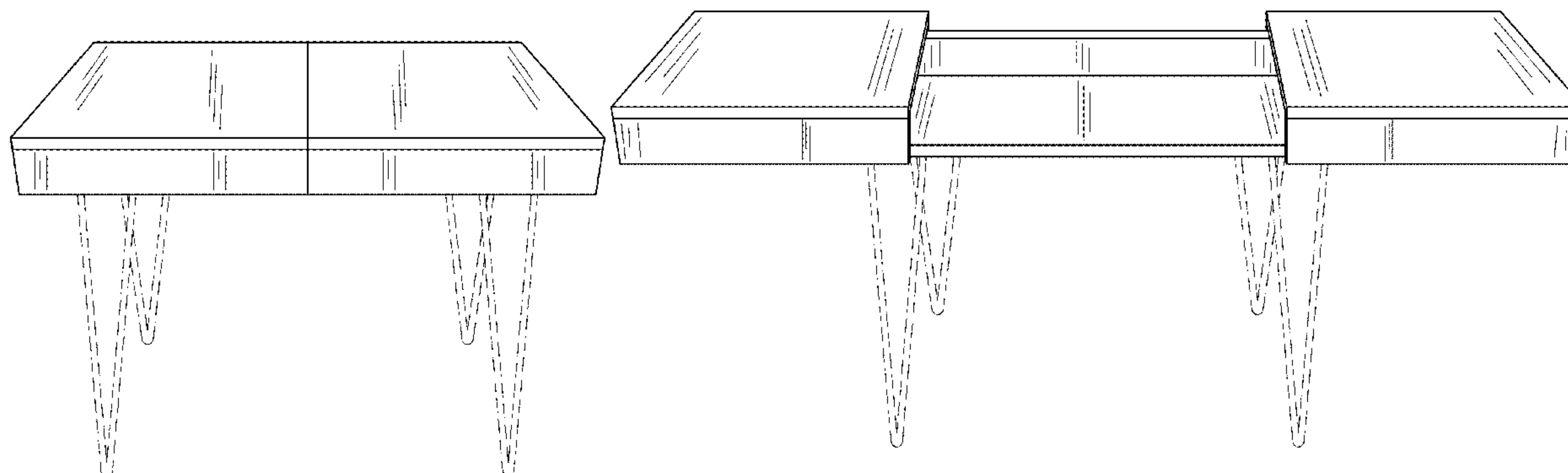
The broken lines shown in the drawings illustrate portions of the desktop with concealable workspace that form no part of the claimed design.

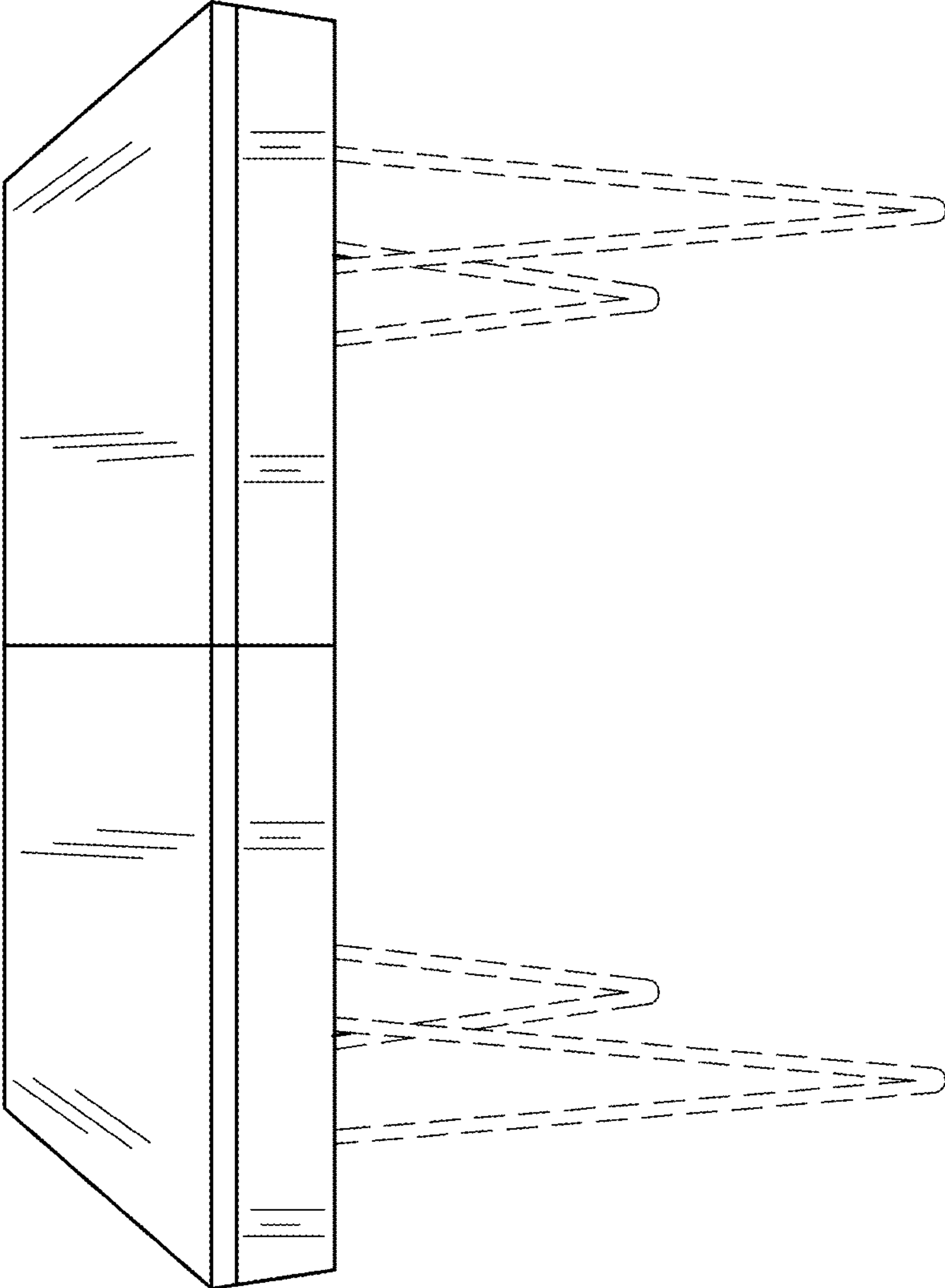
(56) **References Cited**

**U.S. PATENT DOCUMENTS**

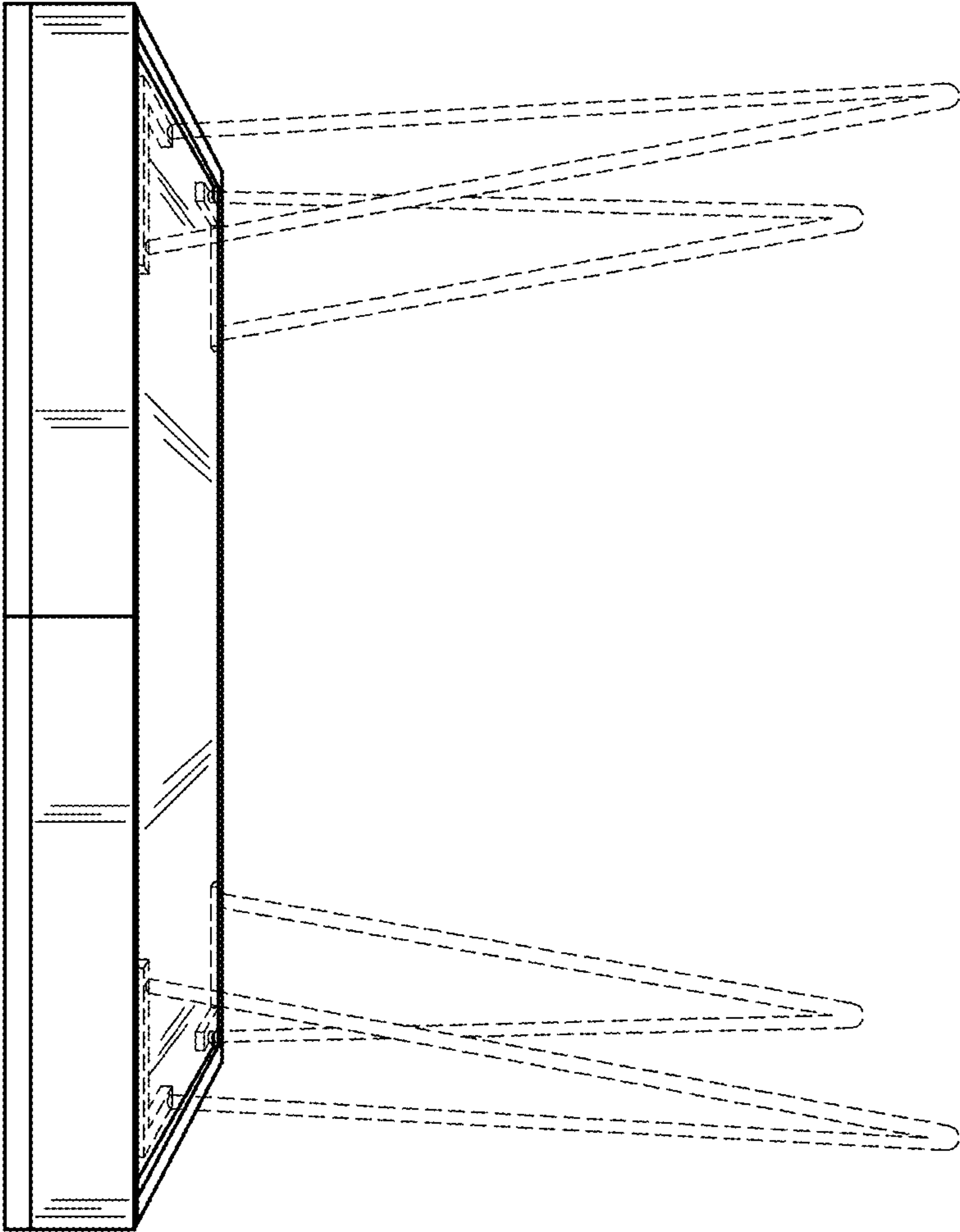
606,834 A \* 7/1898 Curl ..... A47B 1/02 108/86  
1,473,323 A \* 11/1923 Schimmel ..... A47B 1/05 108/69  
6,766,747 B1 \* 7/2004 Wolfe ..... A47B 13/081 108/26  
D584,532 S \* 1/2009 Mohundro ..... D6/686

**1 Claim, 13 Drawing Sheets**

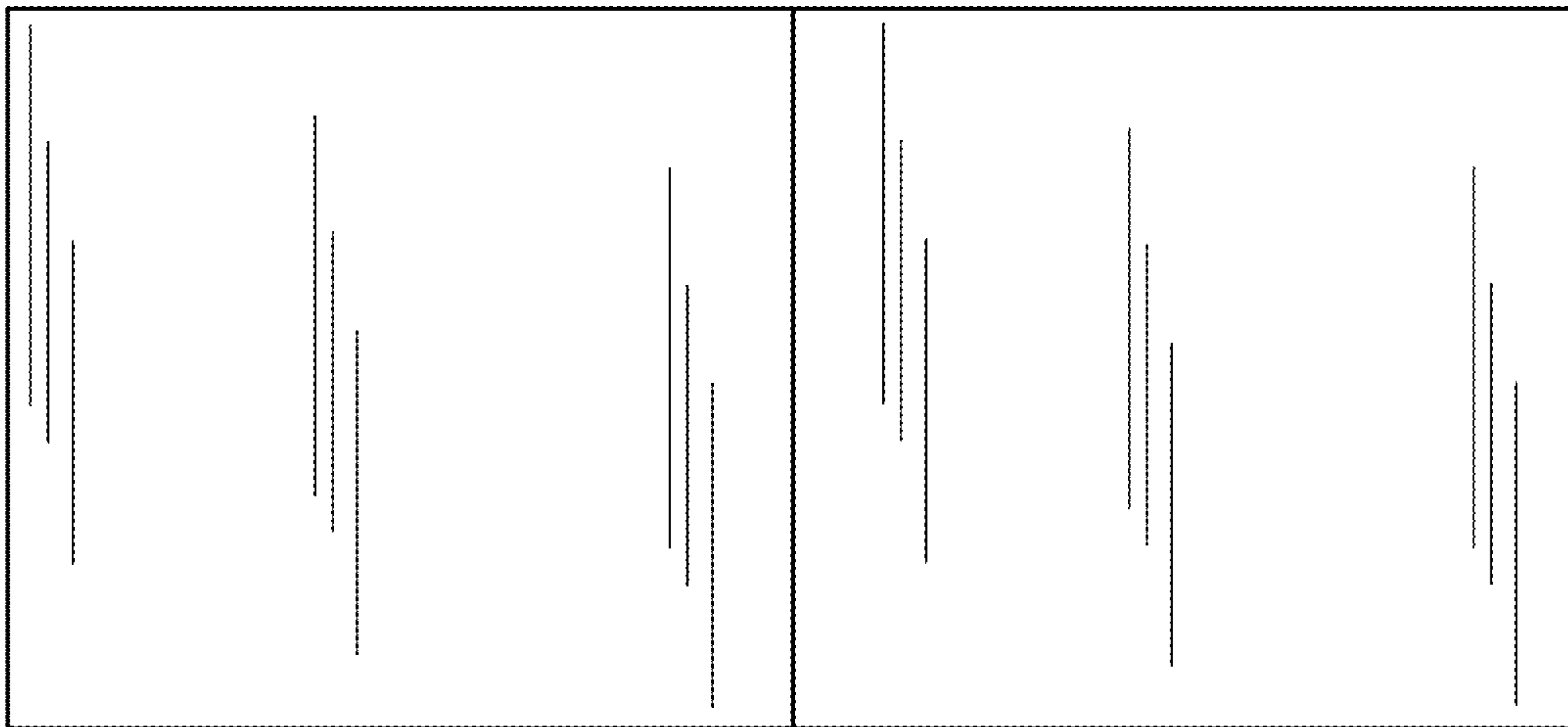




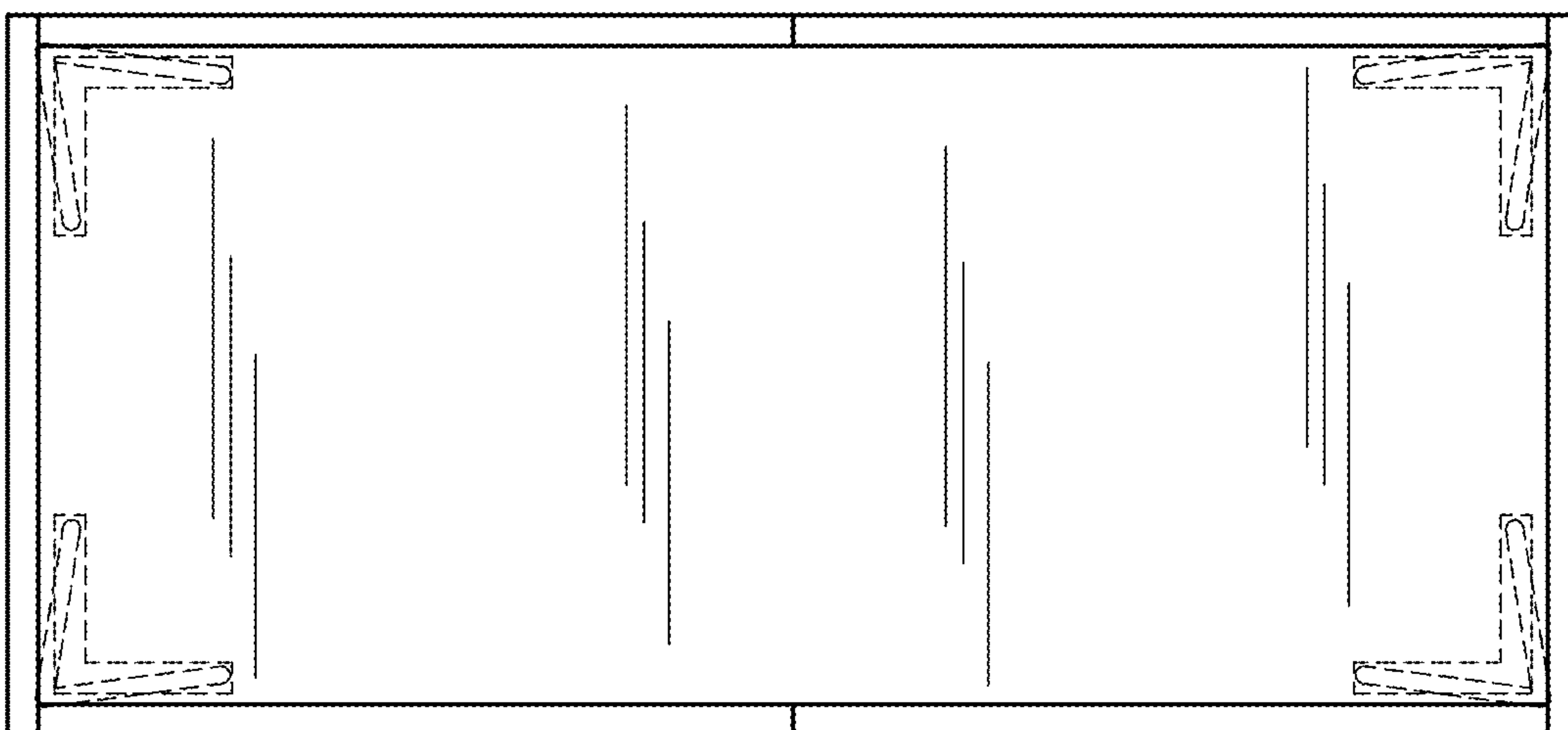
**Fig. 1**



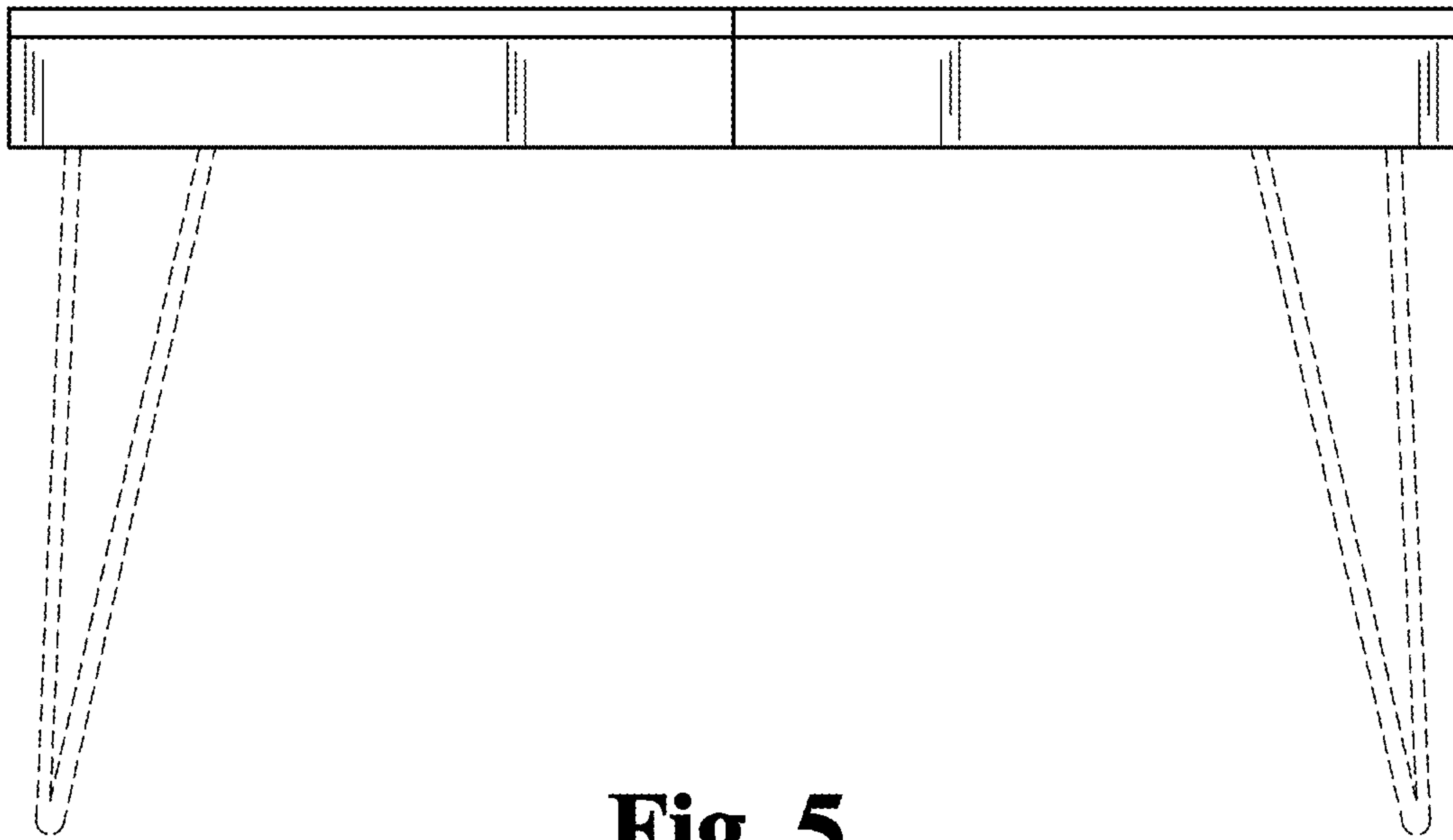
**Fig. 2**



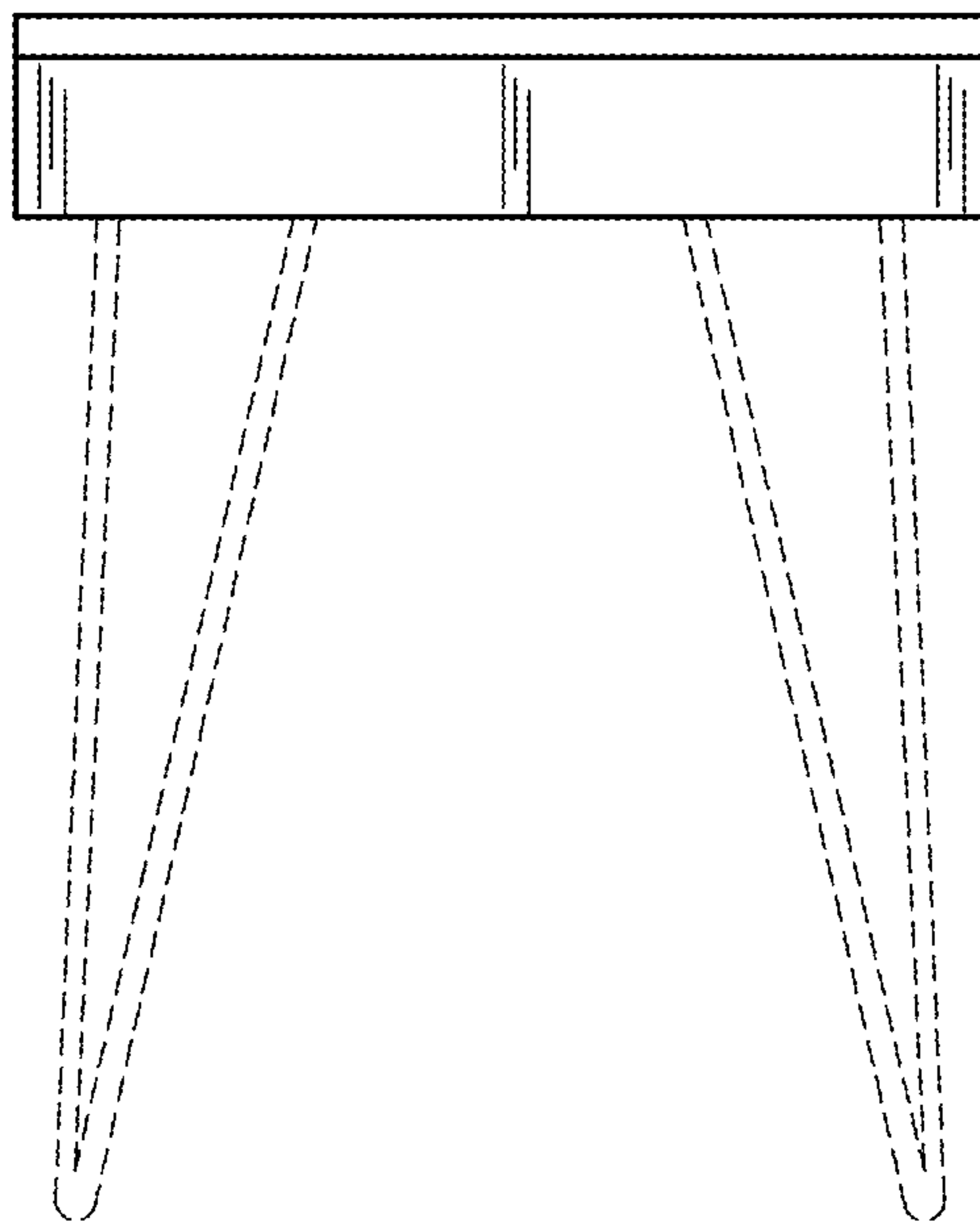
**Fig. 3**



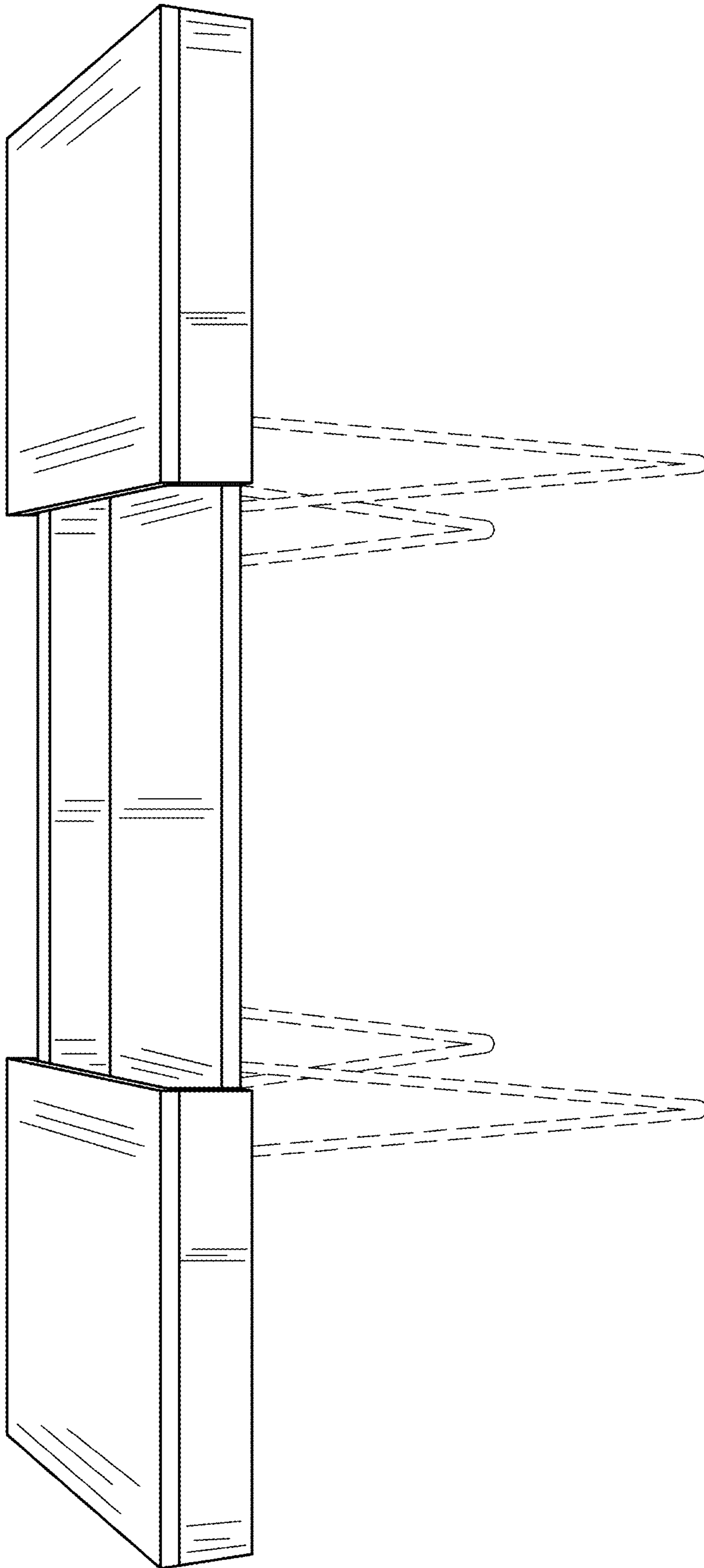
**Fig. 4**



**Fig. 5**

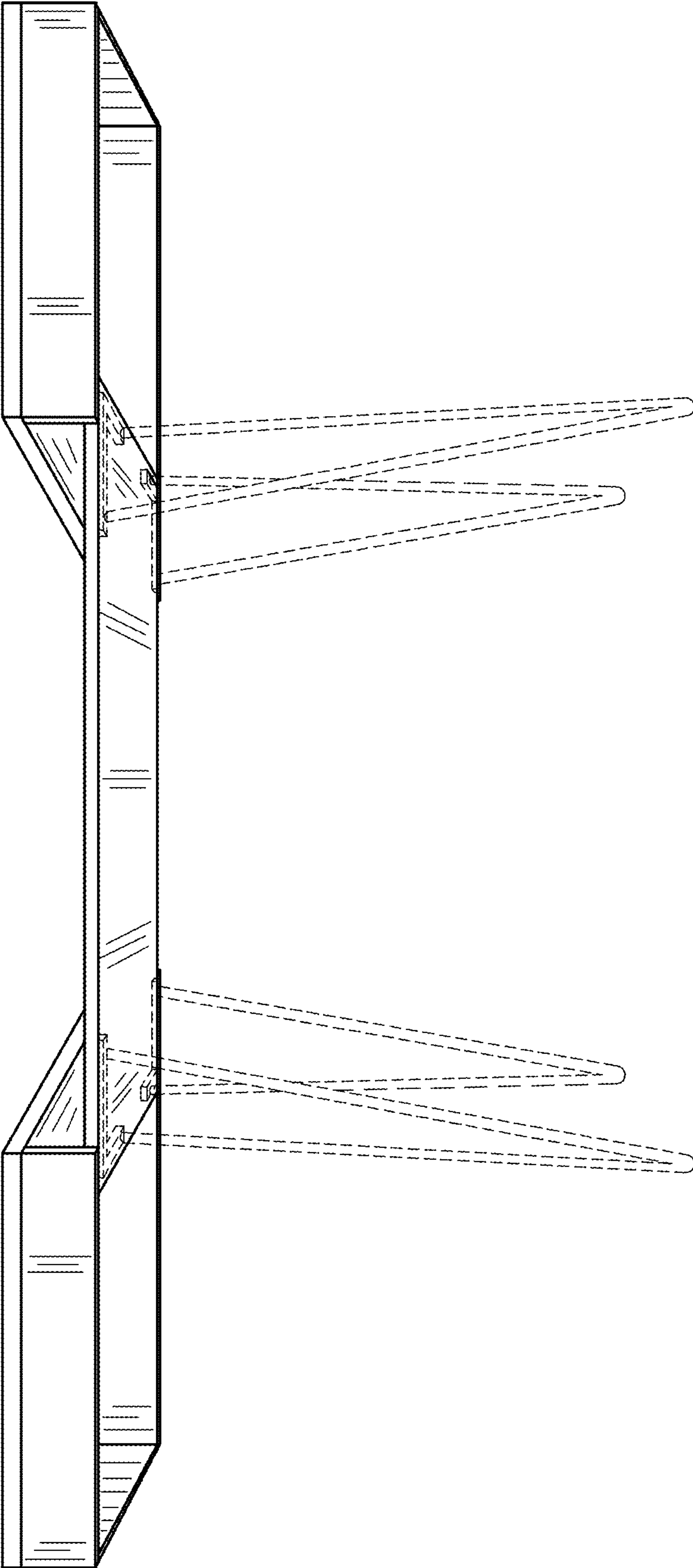


**Fig. 6**

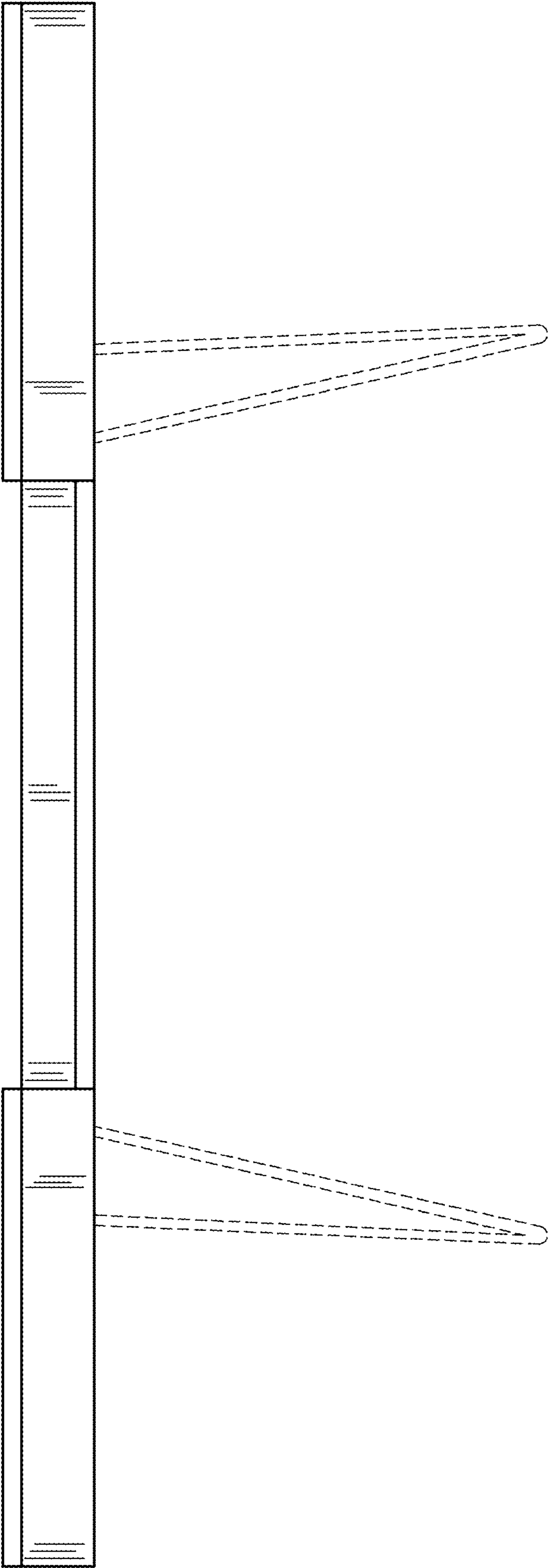


**Fig. 7**



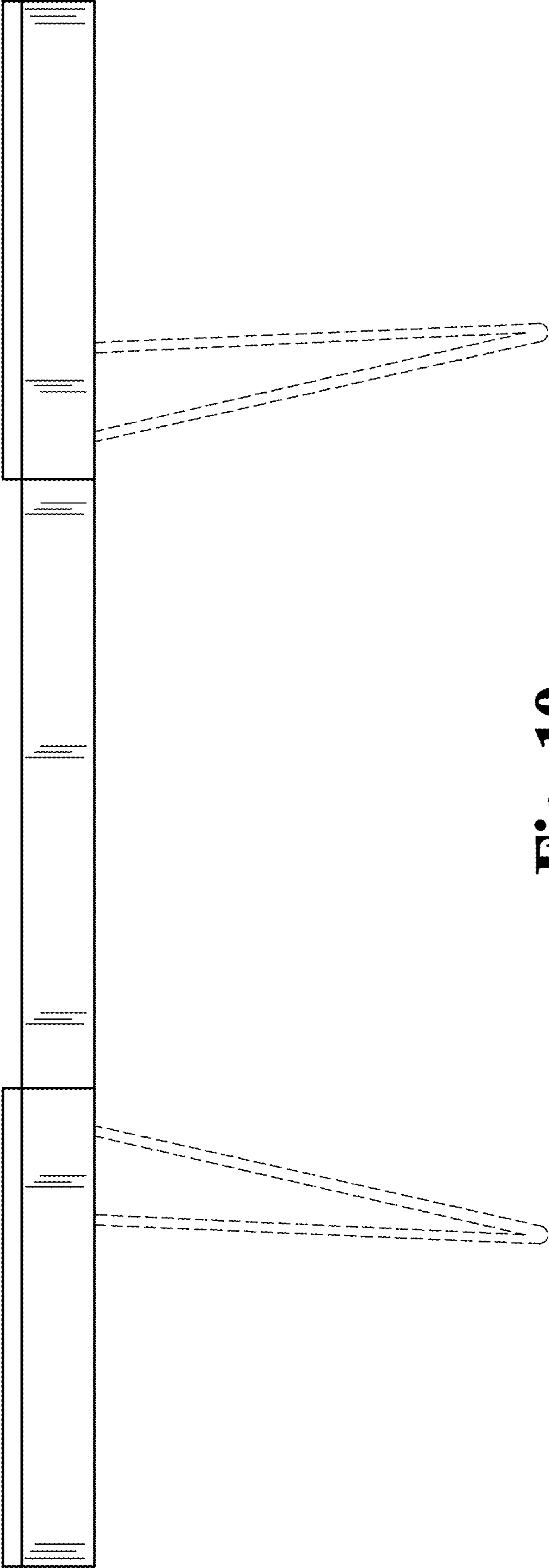


**Fig. 8**

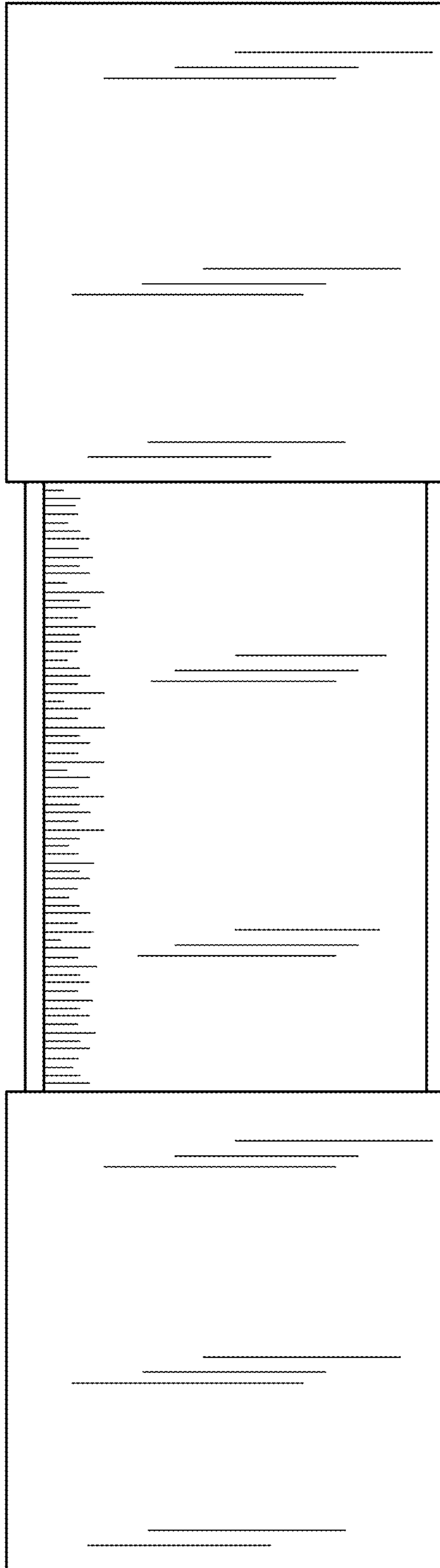


**Fig. 9**

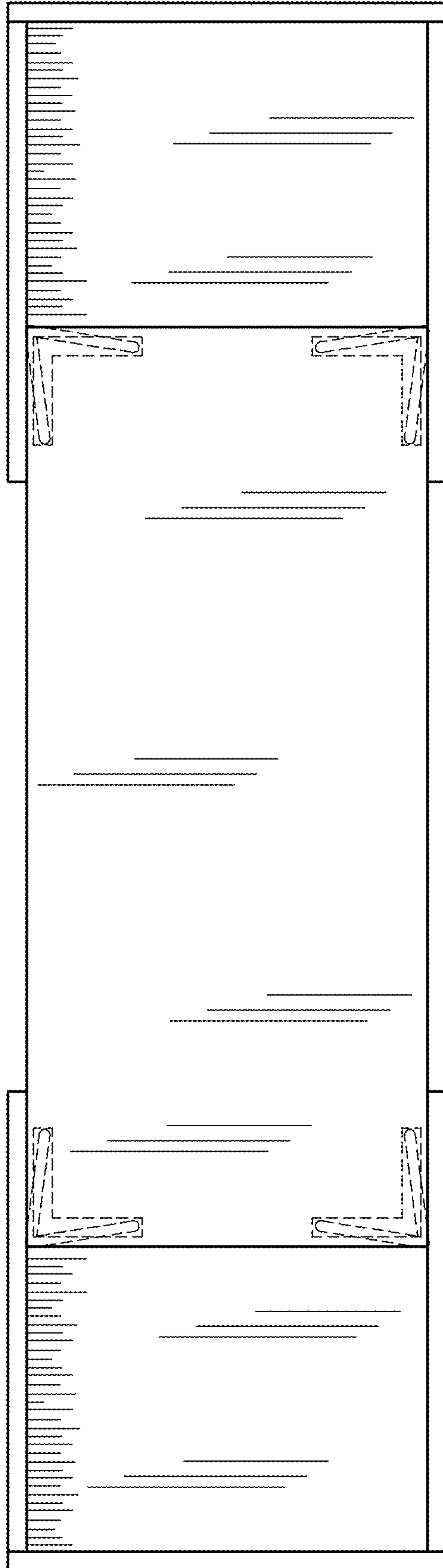




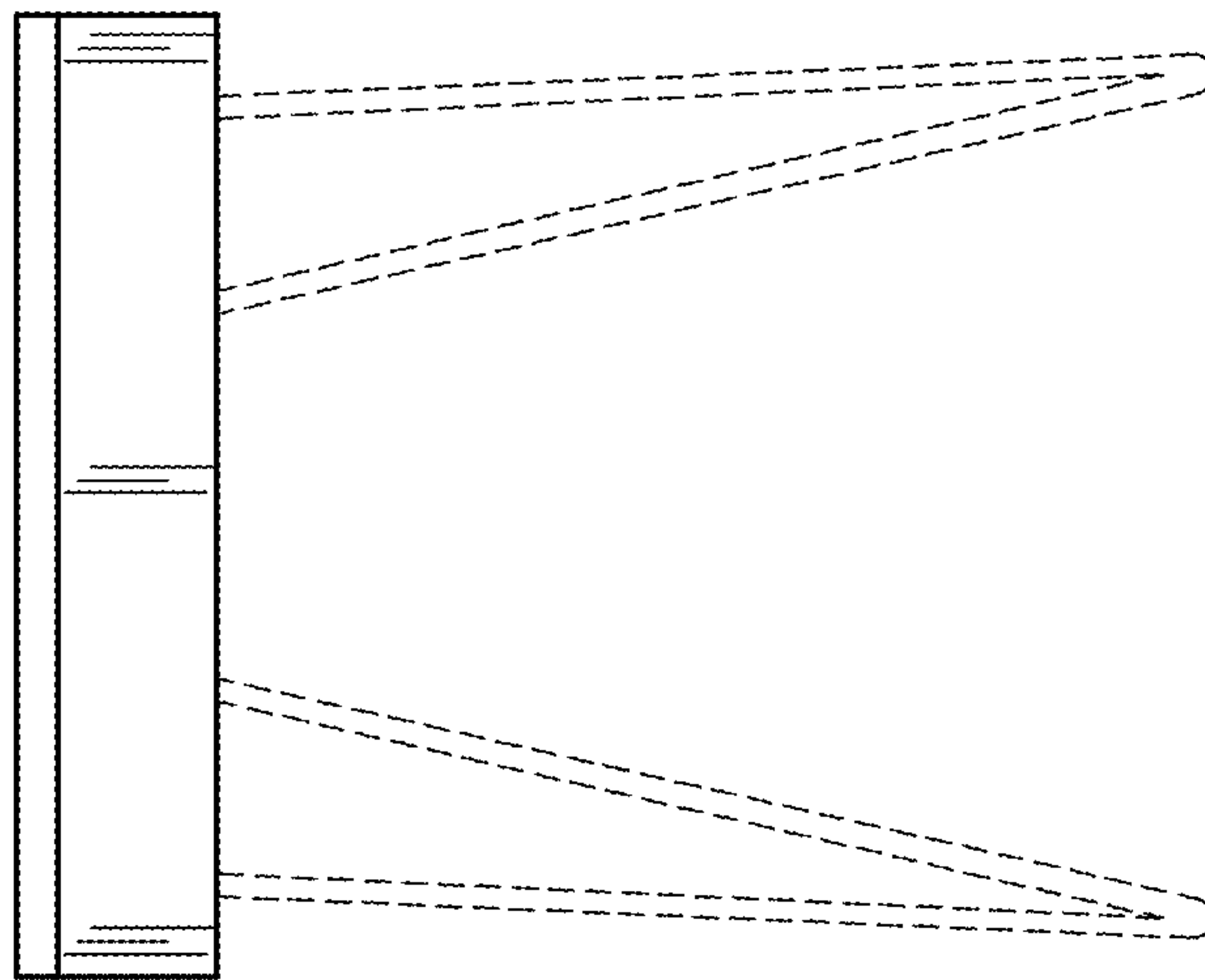
**Fig. 10**



**Fig. 11**



**Fig. 12**



**Fig. 13**

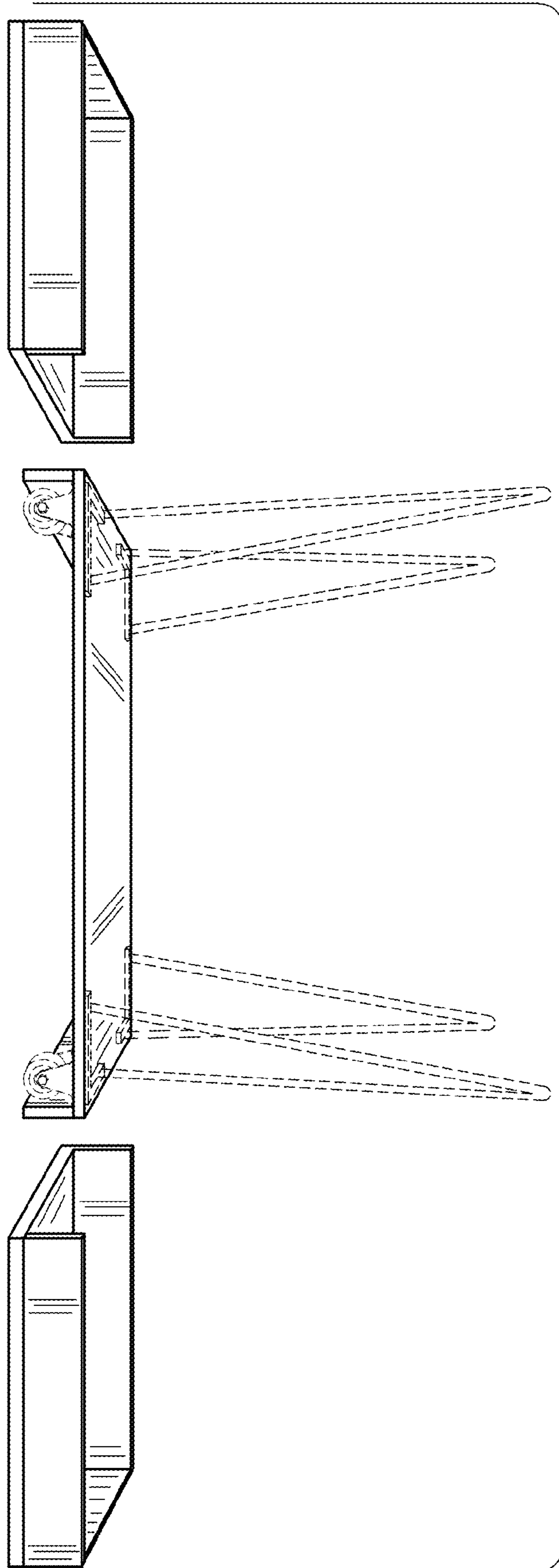


Fig. 14

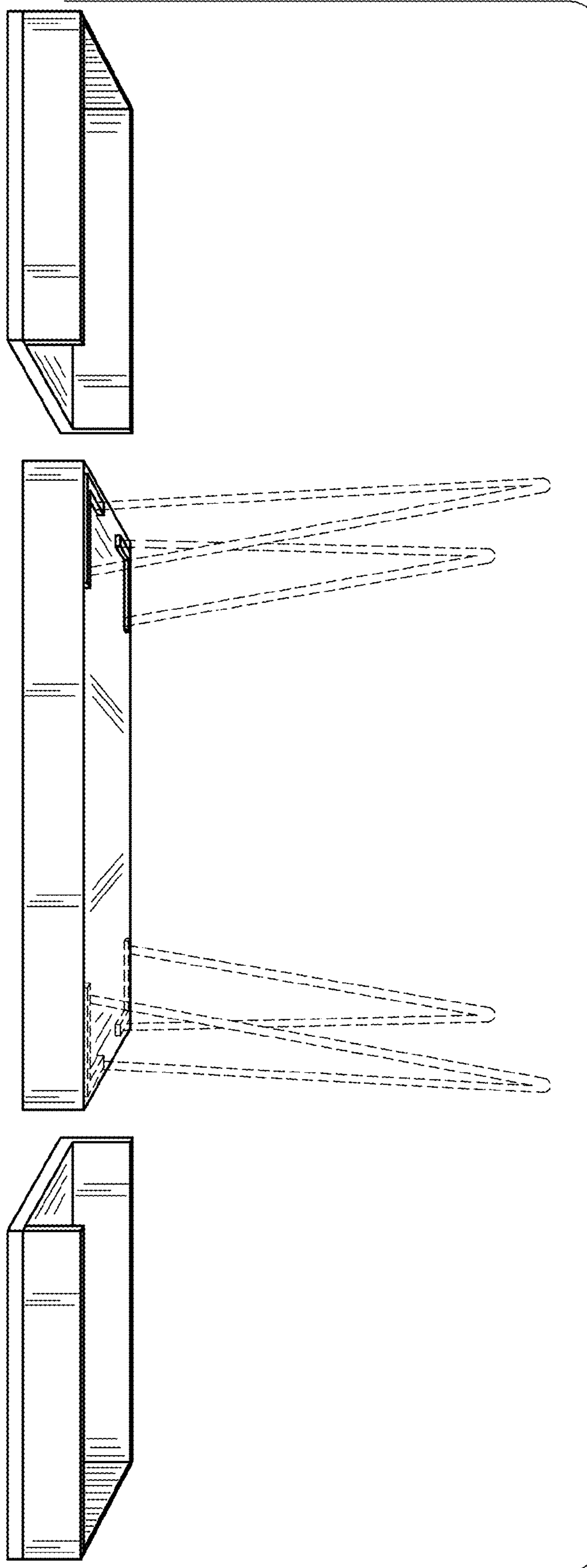


Fig. 15