



US00D882930S

(12) **United States Design Patent**
Seamarks

(10) **Patent No.:** **US D882,930 S**

(45) **Date of Patent:** **** May 5, 2020**

- (54) **SHOE**
- (71) Applicant: **NIKE, Inc.**, Beaverton, OR (US)
- (72) Inventor: **Karl Seamarks**, Portland, OR (US)
- (73) Assignee: **NIKE, Inc.**, Beaverton, OR (US)
- (**) Term: **15 Years**
- (21) Appl. No.: **29/660,129**
- (22) Filed: **Aug. 17, 2018**
- (51) **LOC (12) Cl.** **02-04**
- (52) **U.S. Cl.**
USPC **D2/972**
- (58) **Field of Classification Search**
USPC D2/896, 902, 906-908, 946, 947, 969,
D2/972, 973, 974, 976
CPC A43B 5/00; A43B 13/181; A43B 13/141;
A43B 23/26; A43B 13/188; A43B 23/00
See application file for complete search history.

- D824,644 S * 8/2018 Ly D2/896
- D854,808 S * 7/2019 Hernandez D2/972
- D863,752 S * 10/2019 Taneva D2/972
- D864,552 S * 10/2019 Stocco D2/972

OTHER PUBLICATIONS

Better Off White Collab posted by Mario Briguglio posted date Sep. 24, 2017, © Sneaker Bar Detroit, [online], [site visited Feb. 6, 2020]. Available from Internet, <https://sneakerbardetroit.com/off-white-jordan-1-air-presto/> (Year: 2017).*

Little Presto posted by Nike posted date Nov. 22, 2016, © Amazon, [online], [site visited Feb. 6, 2020]. Available from Internet, https://www.amazon.com/Boys-Nike-Little-Presto-Toddler/dp/B01IDLEB9I/ref=sr_1_13?dchild=1&keywords=nike+presto&qid=1581049251&sr=8-13 (Year: 2016).*

(Continued)

Primary Examiner — Cynthia Ramirez
Assistant Examiner — Laura H Yu
 (74) *Attorney, Agent, or Firm* — Banner & Witcoff, Ltd.

(57) **CLAIM**

The ornamental design for a shoe, as shown and described.

DESCRIPTION

FIG. 1 is a rear perspective view of a shoe showing my new design;
 FIG. 2 is a side view thereof;
 FIG. 3 is a rear view thereof;
 FIG. 4 is an opposite side view thereof;
 FIG. 5 is a second rear perspective view thereof; and,
 FIG. 6 is a front perspective view thereof.
 The broken lines immediately adjacent to the shaded area define the bounds of the claimed design and form no part thereof. The broken lines depicting the remainder of the shoe show features that form no part of the claimed design.

1 Claim, 6 Drawing Sheets

- (56) **References Cited**
- U.S. PATENT DOCUMENTS
- D333,377 S 2/1993 Hatfield
- D380,079 S * 6/1997 Greene D2/972
- D480,547 S * 10/2003 Matis D2/969
- D486,301 S * 2/2004 Koo D2/973
- D487,623 S * 3/2004 Matis D2/969
- D494,348 S * 8/2004 Selbiger D2/969
- D628,784 S * 12/2010 Joseph D2/916
- D776,420 S 1/2017 Petrie
- D781,563 S * 3/2017 Chang D2/972
- D798,578 S * 10/2017 Remy D2/972
- D801,672 S 11/2017 Small
- D802,906 S 11/2017 Nethongkome
- D811,071 S 2/2018 Small
- D822,978 S * 7/2018 Schenone D2/973

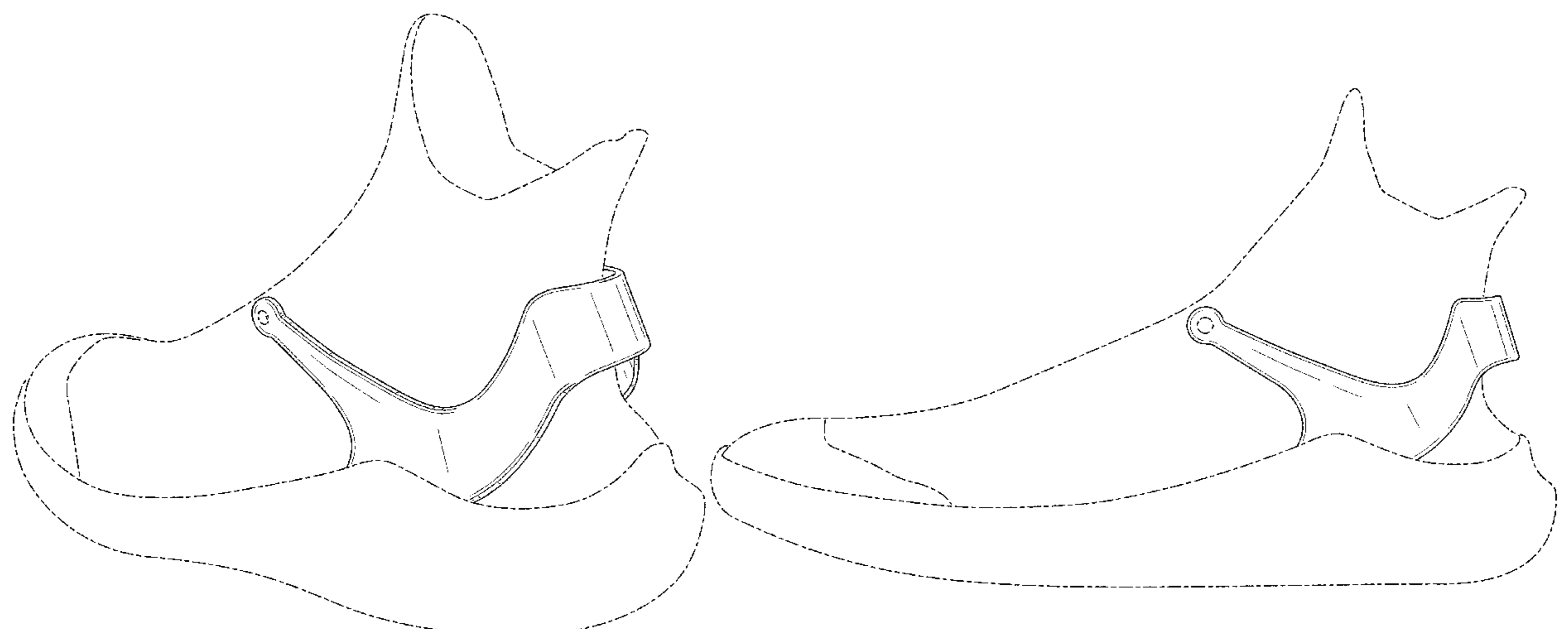

(56)

References Cited

OTHER PUBLICATIONS

Look for the Adidas Tubular Doom in 2016 [online], retrieved Oct. 18, 2018], retrieved from Kicks On Fire [Internet] <URL: <https://www.kicksonfire.com/look-for-the-adidas-tubular-doom-in-2016/>>; 3 color sheets, Dated Dec. 18, 2018.

Nike Free RN 2018 Review [online], retrieved Oct. 18, 2018], retrieved from Running Shoes Guru [Internet] <URL: <https://www.runningshoesguru.com/2018/04/nike-free-rn-2018-review/#>>; 13 color sheets, Dated Apr. 28, 2018.

Travel in Style This Holiday Season With the Nike Air Huarache Ultra [online], retrieved Oct. 18, 2018], retrieved from Sneaker News [Internet] <URL: <https://sneakernews.com/2015/12/17/the-nike-huarache-ultra-is-perfect-for-traveling-among-other-things/>>; 13 color sheets, Dated Dec. 17, 2015.

Nike Dynamo Free [online], retrieved Oct. 18, 2018], retrieved from Amazon [Internet] <URL: <https://www.amazon.com/NIKE-Dynamo-Free/dp/B06XXLNX72>>; 8 color sheets, Dated Feb. 12, 2018.

Nike Free RN Flyknit 2017 Review [online], retrieved Oct. 18, 2018], retrieved from Running Shoes Guru [Internet] <URL: <https://www.runningshoesguru.com/2017/06/nike-free-rn-flyknit-2017-review/>>; 15 color sheets, Dated Jun. 22, 2017.

Nike Free 3.0 Flyknit 2015 Review: Flexible Sole, Sock-Like Upper, and Solid Cushioning in a Lightweight Package [online], retrieved Oct. 18, 2018], retrieved from Run Blogger [Internet] <URL: <https://runblogger.com/2015/05/nike-free-3-0-flyknit-2015-review-flexible-sole-sock-like-upper-and-solid-cushioning-in-a-lightweight-package.html>>; 7 color sheets, Dated May 28, 2015.

Nike Free Flyknit 4.0 Review [online], retrieved Oct. 18, 2018], retrieved from Running Shoes Guru [Internet] <URL: <https://www.runningshoesguru.com/2015/08/nike-free-flyknit-4-0-review/>>; 12 color sheets, Dated Nov. 25, 2017.

Nike Air Presto Ultra Breathe Arctic Orange [online], retrieved Oct. 19, 2018], retrieved from Kicks On Fire [Internet] <URL: <https://www.kicksonfire.com/app/nike-air-presto-ultra-breathe-arctic-orange>>; 14 color sheets, Dated Mar. 24, 2017.

Nike Footwear Catalog, 1983 Footwear, p. 3, published Jan. 1983, NIKE, Inc., USA.

* cited by examiner

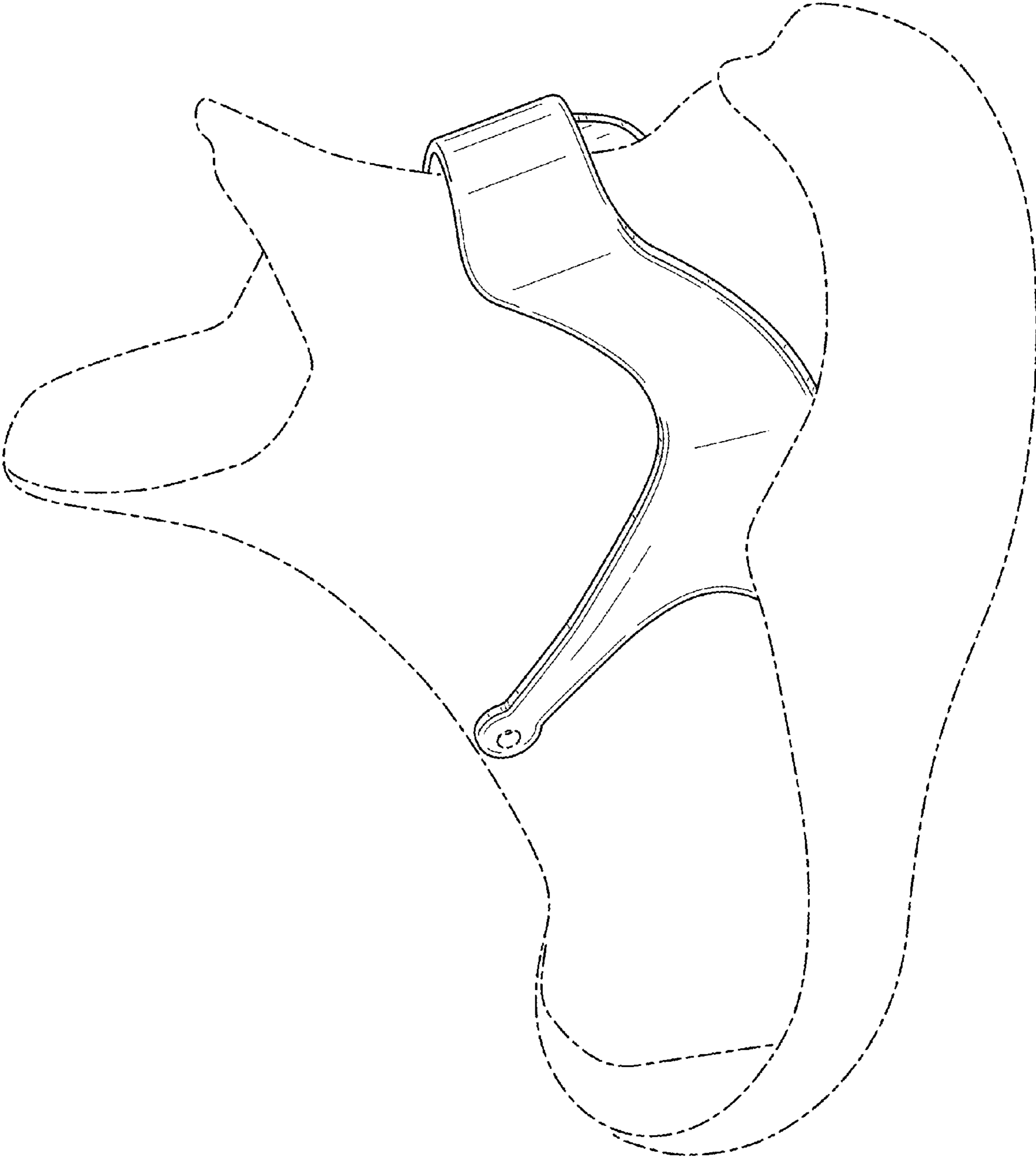

FIG. 1

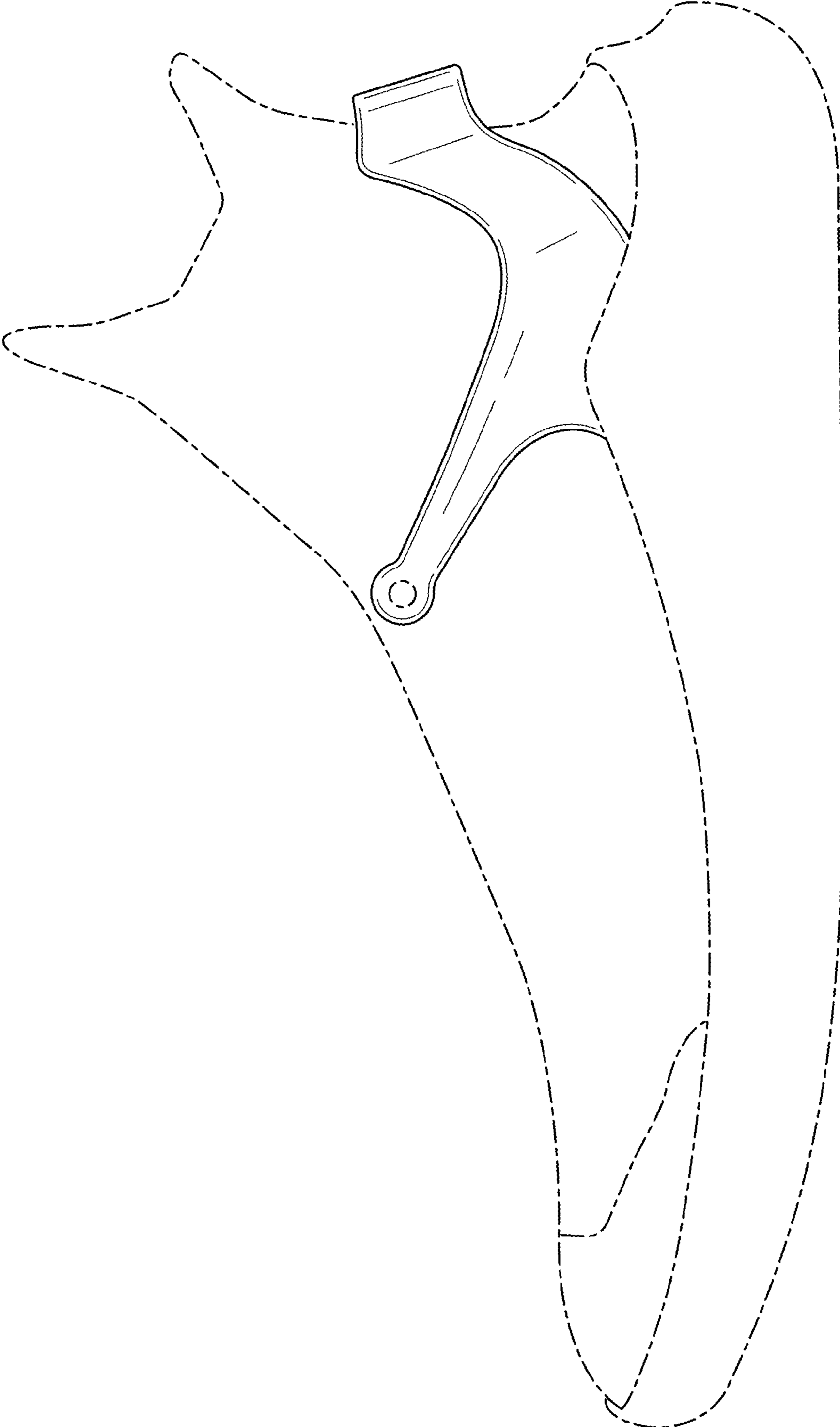

FIG. 2

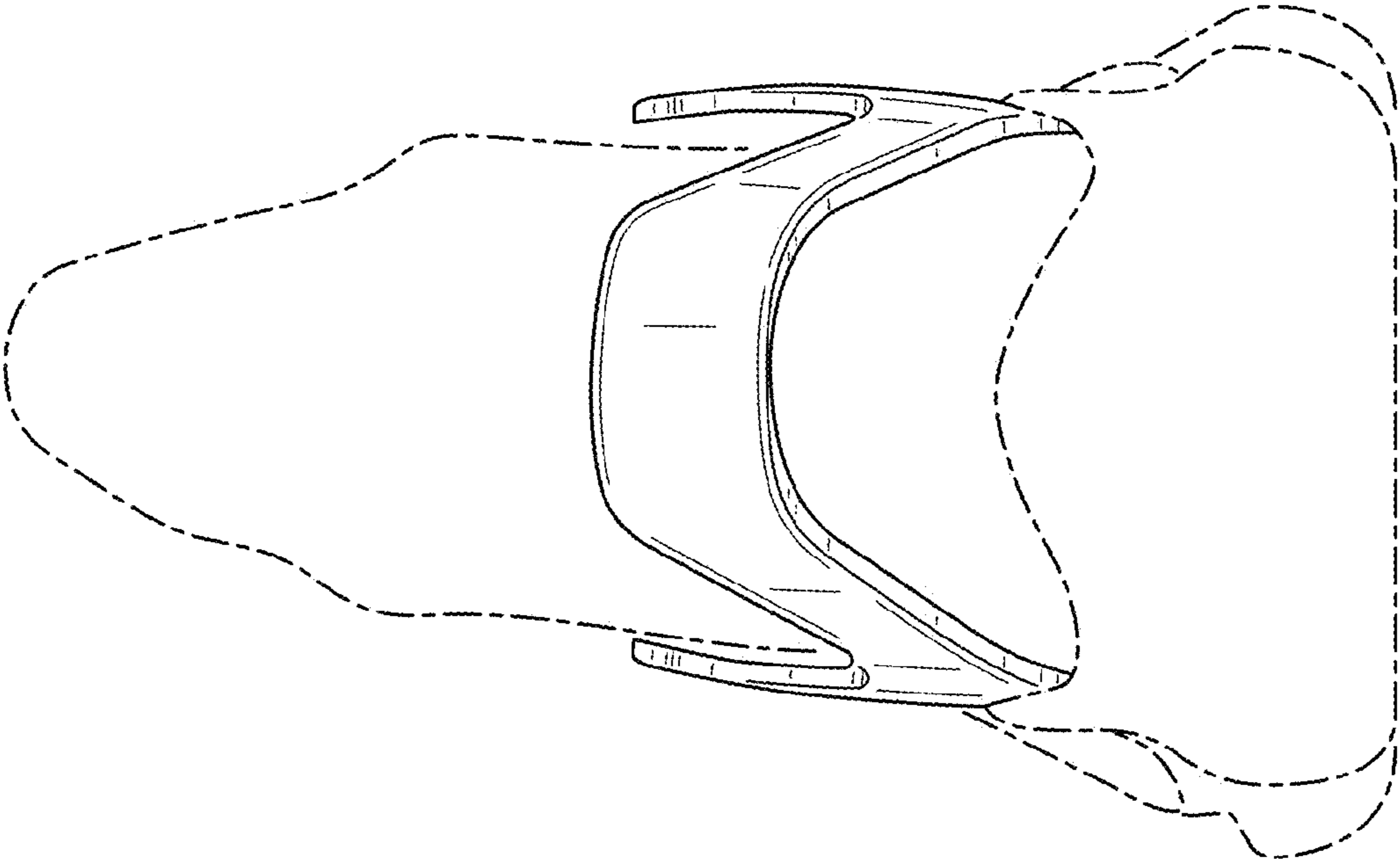

FIG. 3

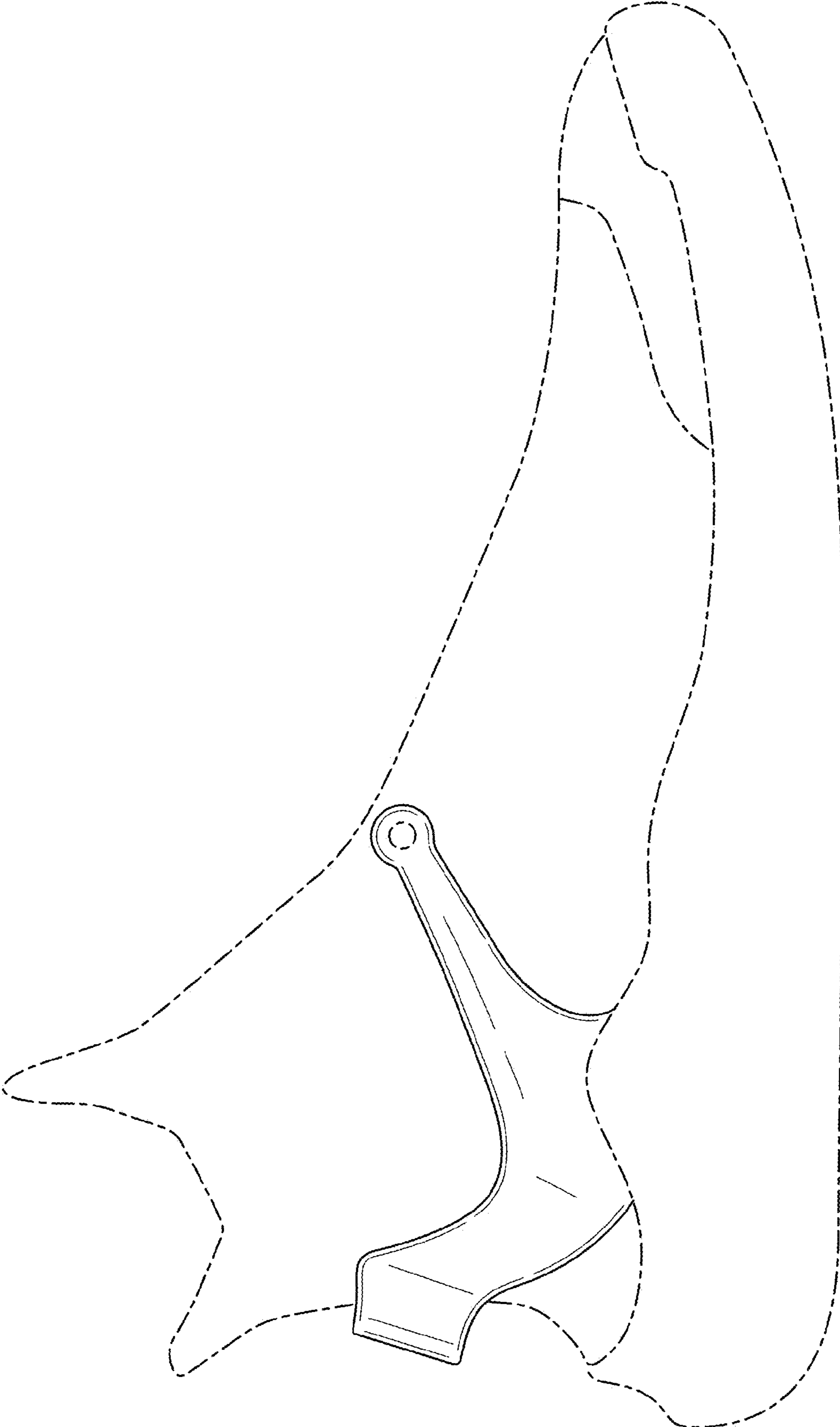

FIG. 4

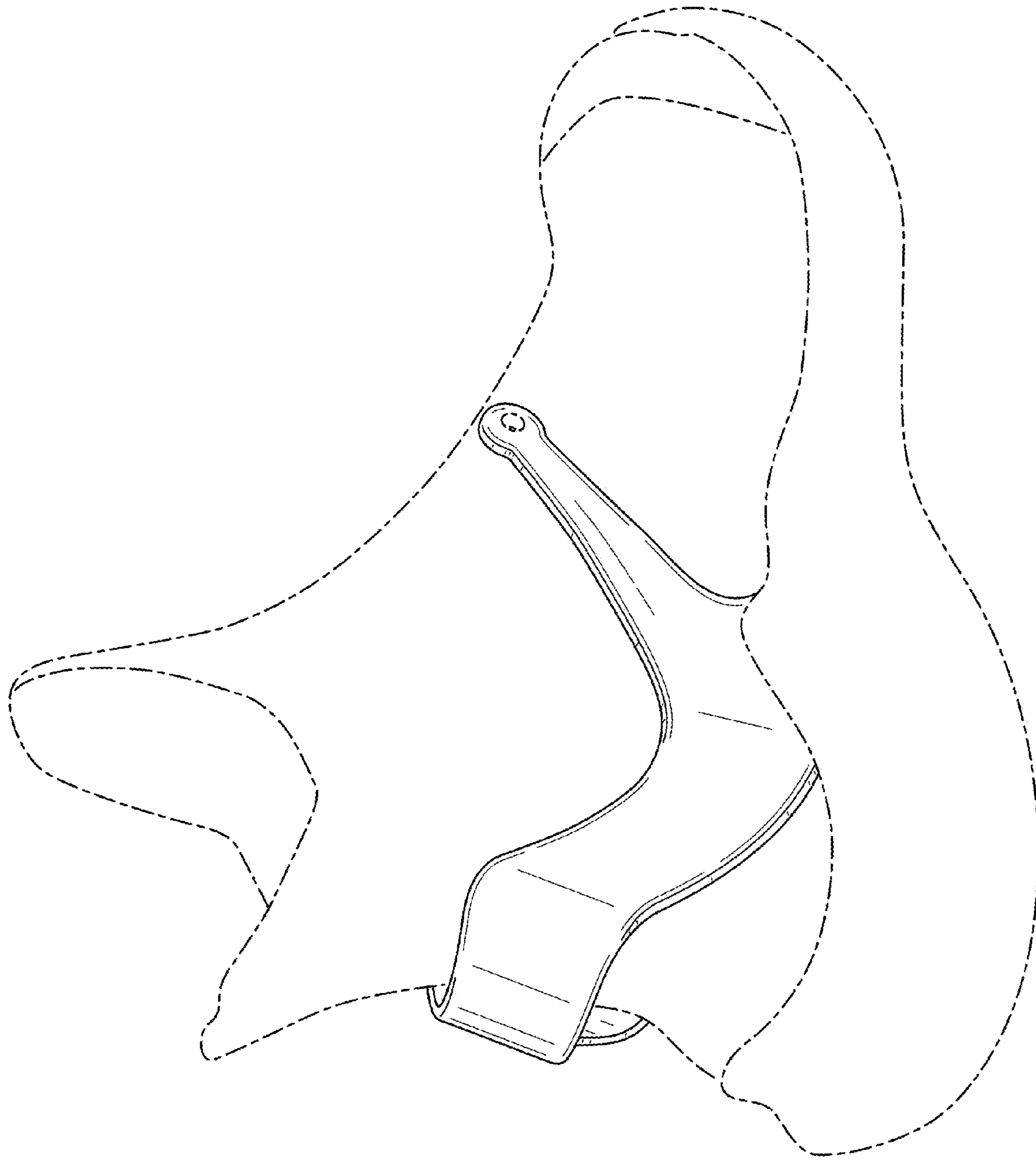

FIG. 5

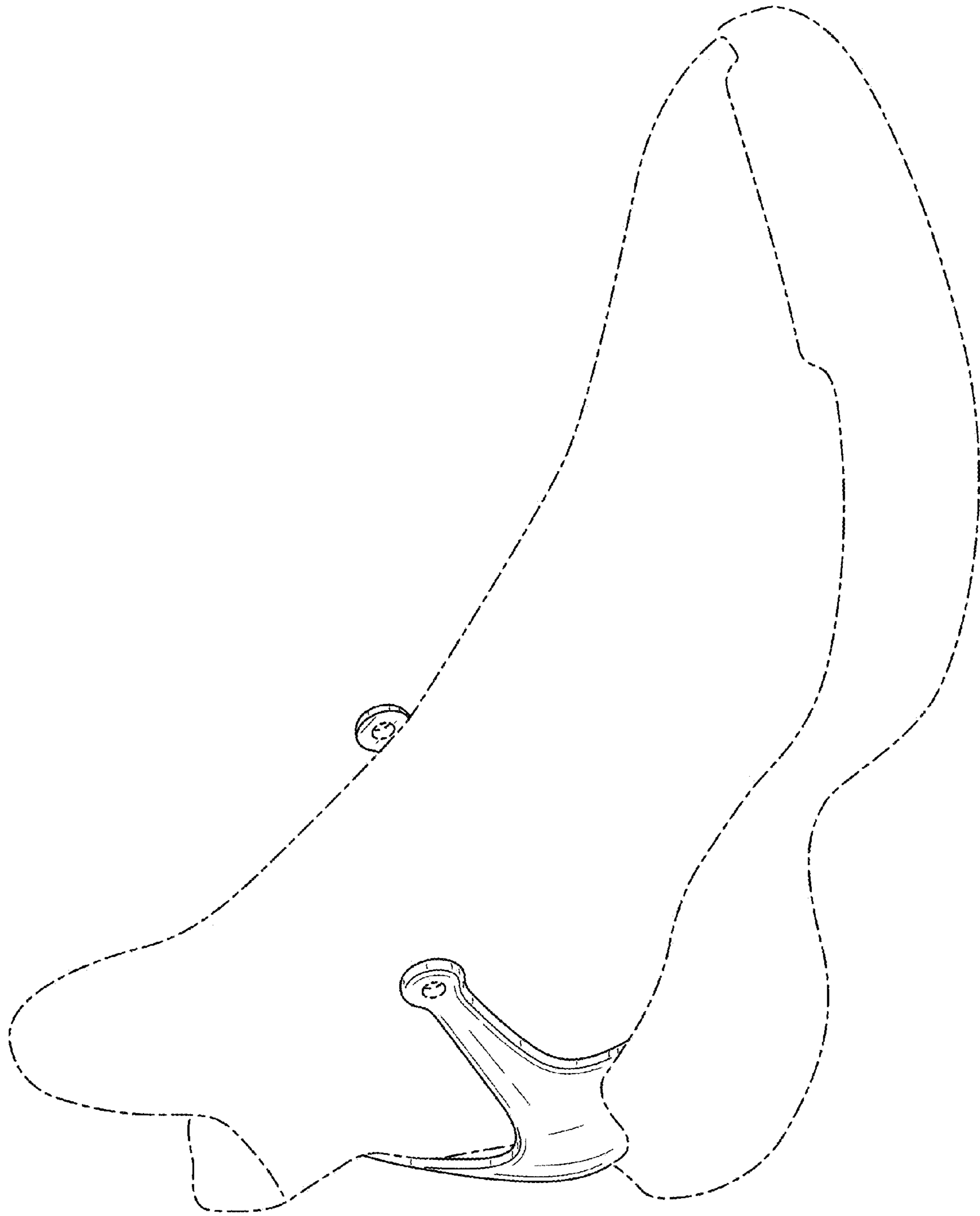

FIG. 6