



US00D882790S

(12) **United States Design Patent**
Qun

(10) **Patent No.:** **US D882,790 S**

(45) **Date of Patent:** **** Apr. 28, 2020**

(54) **ULTRASONIC CUTTER HEAD**

(71) Applicant: **BEIJING SMTP TECHNOLOGY CO., LTD.**, Beijing (CN)

(72) Inventor: **Cao Qun**, Beijing (CN)

(73) Assignee: **BEIJING SMTP TECHNOLOGY CO., LTD.**, Beijing (CN)

(**) Term: **15 Years**

(21) Appl. No.: **29/635,577**

(22) Filed: **Jan. 31, 2018**

(51) **LOC (12) Cl.** **24-02**

(52) **U.S. Cl.**
USPC **D24/146**

(58) **Field of Classification Search**
USPC D24/108, 133, 150, 152, 155, 176, 210, D24/231, 216, 232, 185, 186, 104, D24/112-114, 117-119, 127, 141, 144, D24/146, 147, 148, 188, 207, 200, 209, D24/215, 171; D15/21, 22, 23, 24, 25, D15/26, 27, 28, 29, 138, 139, 140; D8/70, 95, 96, 98; D25/126; D28/7, 9, D28/20

CPC B23B 51/02; B23B 51/08; B23B 51/10; B23B 51/00; B23B 2251/50; B23B 2251/18; B23B 2251/46; B23B 2222/28; B23B 2240/08; Y10S 408/713; Y10T 407/26; Y10T 408/9097; Y10T 408/899; Y10T 408/90; A61C 3/02; A61C 8/0089; A61C 1/07; A61B 17/3213; A61B 17/3417; A61B 17/14; A61B 17/142; A61B 17/320016; A61B 17/32002; A61B 17/3211; A61B 2017/00473; A61B 2017/320032; A61B 2017/32113; A61B 2017/32116; A61B 2017/3454; A61B 2018/1412; A61B 90/30; A61B 17/144; A61B 17/1615; A61B 17/162; A61B 17/1624; A61B 17/1633; A61B 17/1637; A61B 17/1659; A61B 17/16; A61B

17/1604; A61B 2017/00261; A61B 2017/320075; A61B 2017/32007; A61B 2017/320077; A61B 2217/007; A61B 17/1642; A61B 17/1671; B23D 77/02; (Continued)

(56) **References Cited**

U.S. PATENT DOCUMENTS

D302,298 S * 7/1989 Chechelski D24/147
D511,002 S * 10/2005 Easley D24/144
(Continued)

OTHER PUBLICATIONS

Sonopet Ultrasonic Aspirator <https://neurosurgical.stryker.com/wp-content/uploads/2016/09/SONOPET-catalog-brochure.pdf> 2016 (Year: 2016).*

Primary Examiner — Samantha Q Lawrence
(74) *Attorney, Agent, or Firm* — Maschoff Brennan

(57) **CLAIM**

The ornamental design for an ultrasonic cutter head, as shown and described.

DESCRIPTION

FIG. 1 is a top, front, and left side perspective view of an ultrasonic cutter head, showing our new design; FIG. 2 is a top plan view thereof; FIG. 3 is a left side view thereof; FIG. 4 is a right side view thereof; FIG. 5 is a bottom plan view thereof; FIG. 6 is a front elevational view thereof; FIG. 7 is a rear elevational view thereof; and, FIG. 8 is a full view thereof. The broken lines shown in FIGS. 1-5 and FIGS. 7-8 atop the cylinder illustrate boundaries of the ultrasonic cutter head. The additional broken lines shown in FIG. 8 illustrate environment and form no part of the claimed design.

1 Claim, 3 Drawing Sheets

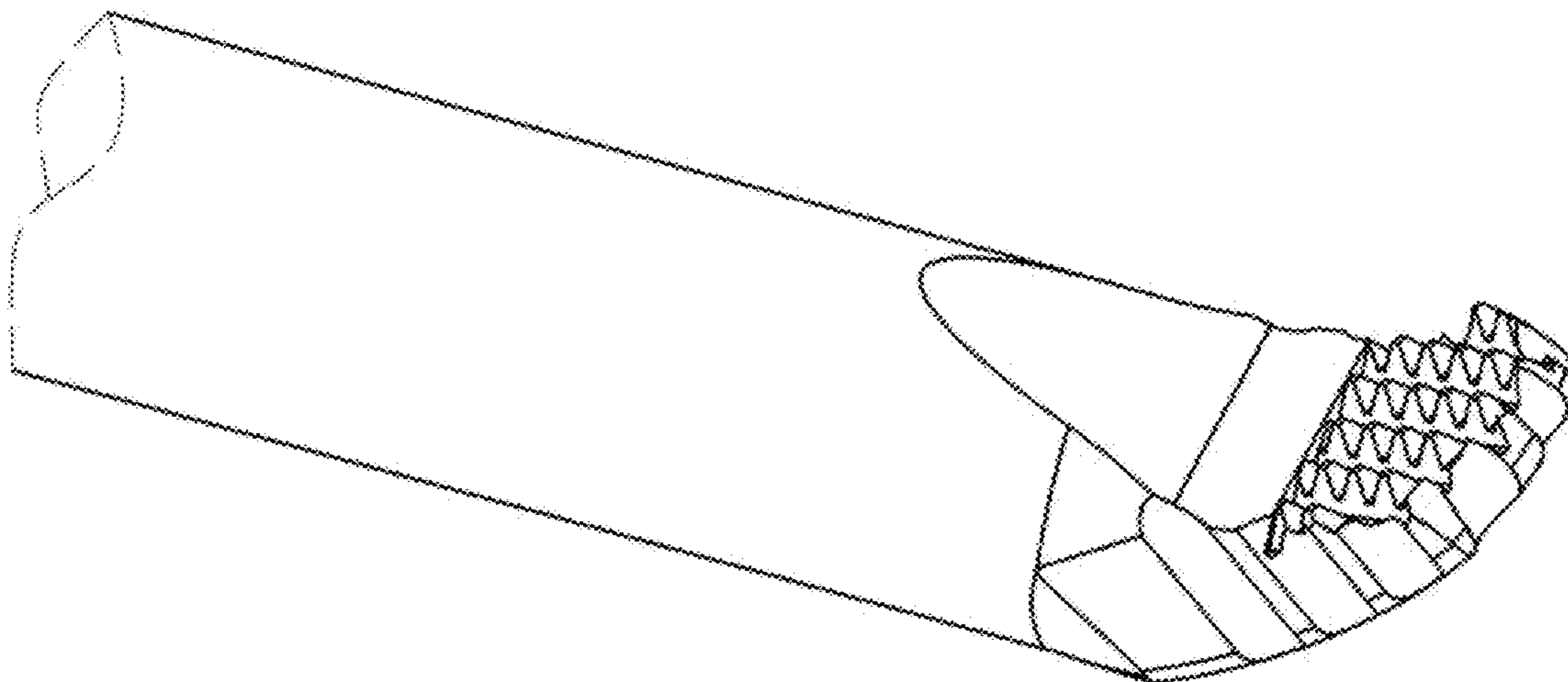

(58) **Field of Classification Search**

CPC B23D 61/006; B23D 61/121; B23P 15/32;
B27B 19/006

See application file for complete search history.

(56) **References Cited**

U.S. PATENT DOCUMENTS

7,223,267	B2 *	5/2007	Isola	A61B 17/32006 606/169
8,353,912	B2 *	1/2013	Darian	A61B 17/32006 606/84
8,430,897	B2 *	4/2013	Novak	A61B 17/32006 606/169
8,512,340	B2 *	8/2013	Easley	A61B 17/1659 606/79
9,622,766	B2 *	4/2017	Voic	A61B 17/32078
9,872,697	B2 *	1/2018	Voic	A61B 17/32006
10,398,463	B2 *	9/2019	Darian	A61B 17/32006
2004/0030254	A1 *	2/2004	Babaev	A61B 17/54 600/459
2005/0177184	A1 *	8/2005	Easley	A61B 17/1659 606/167
2018/0228551	A1 *	8/2018	Moe	A61B 17/32002
2019/0110799	A1 *	4/2019	Sun	A61B 17/32
2019/0183521	A1 *	6/2019	Li	A61B 17/1604
2019/0223898	A1 *	7/2019	Curtin	A61B 17/32002
2019/0231379	A1 *	8/2019	Edwards	A61B 17/32002

* cited by examiner

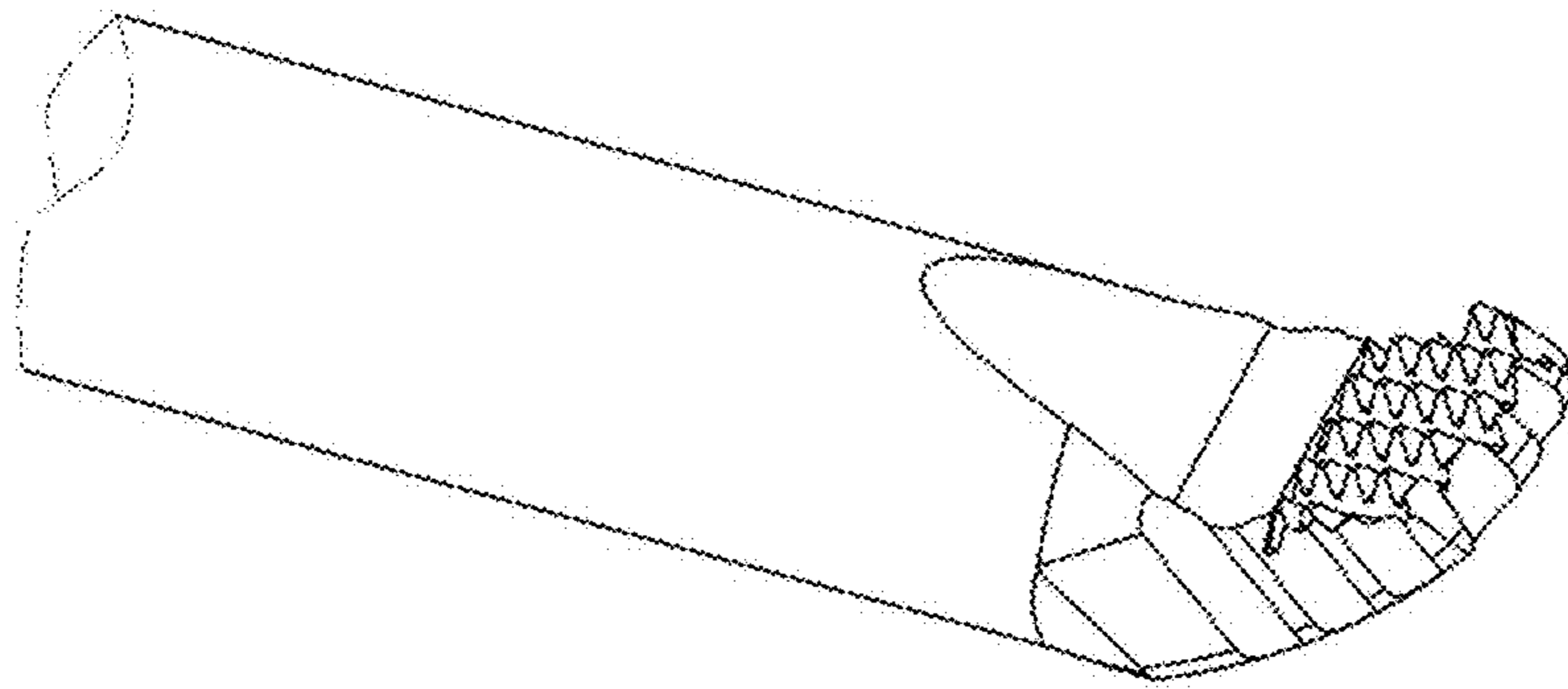

Fig.1

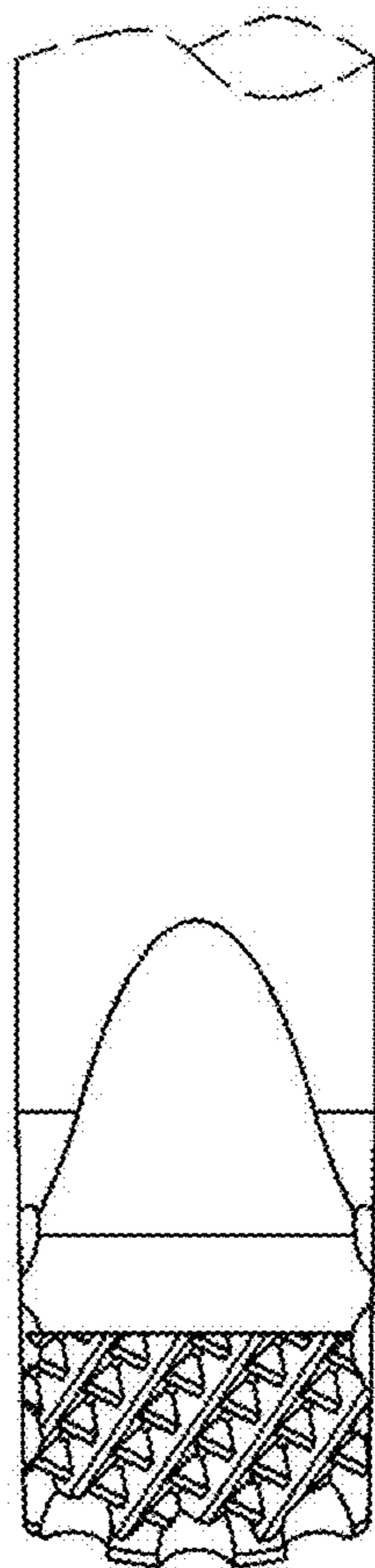

Fig.2

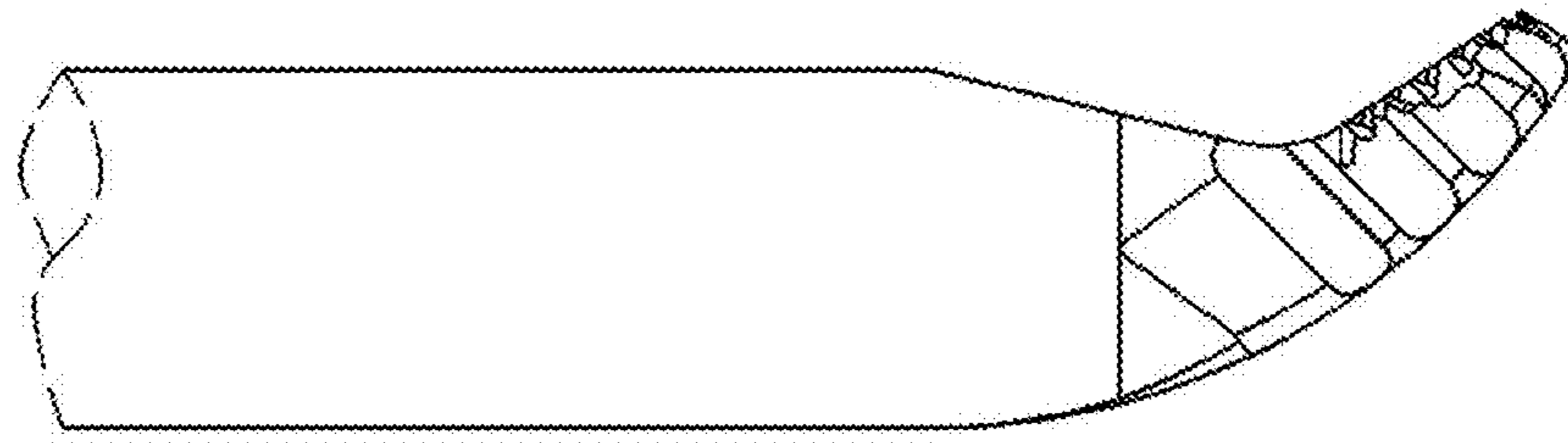

Fig.3

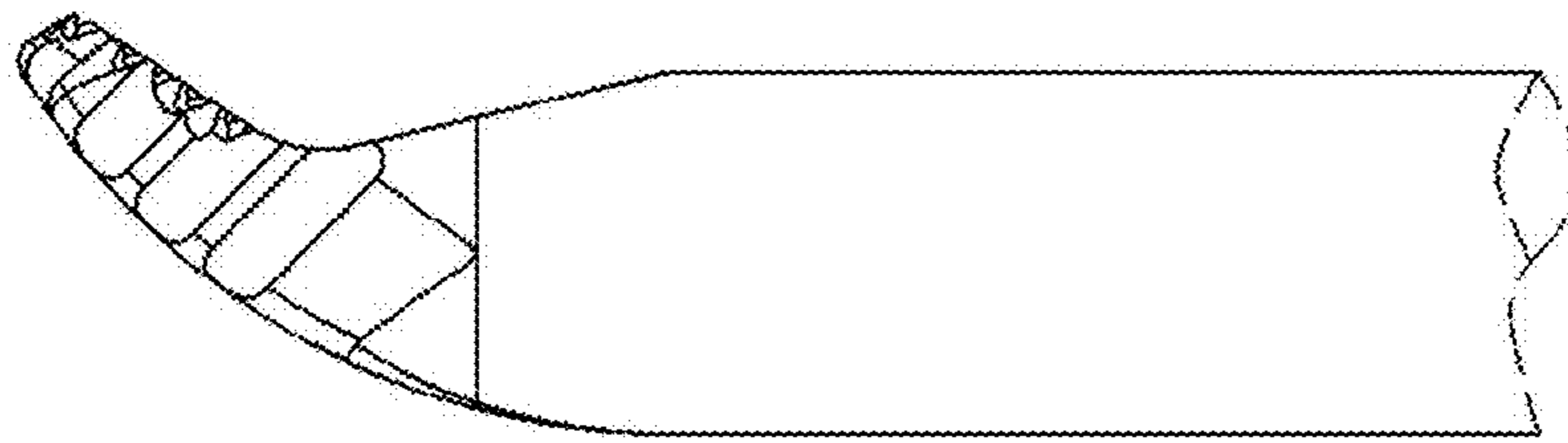

Fig.4

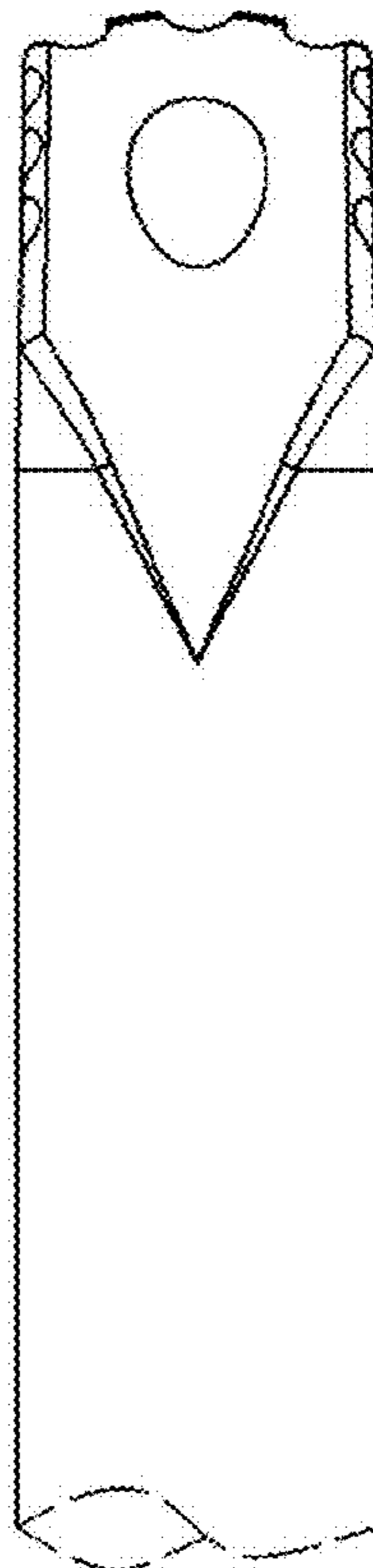

Fig.5

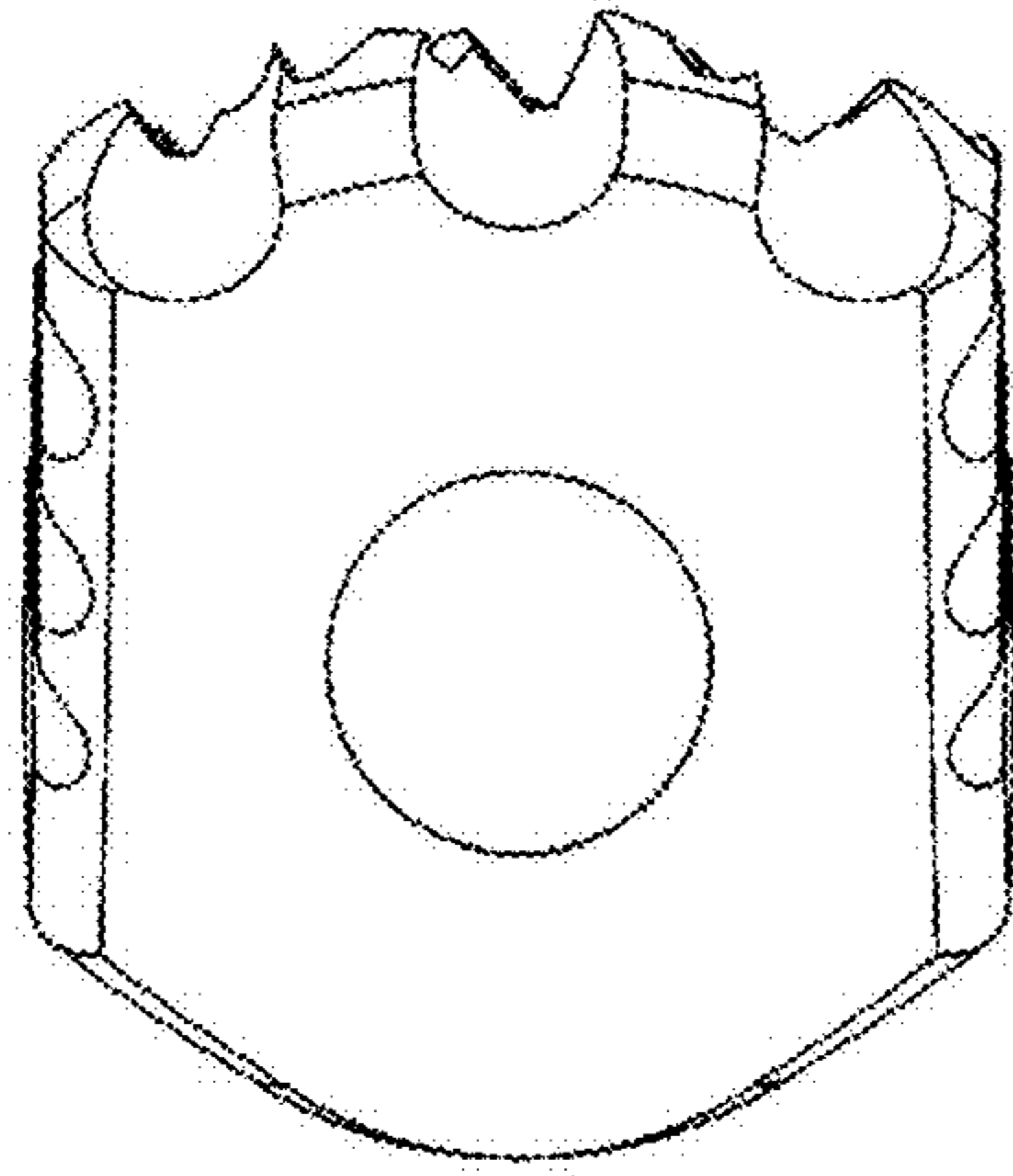

Fig. 6

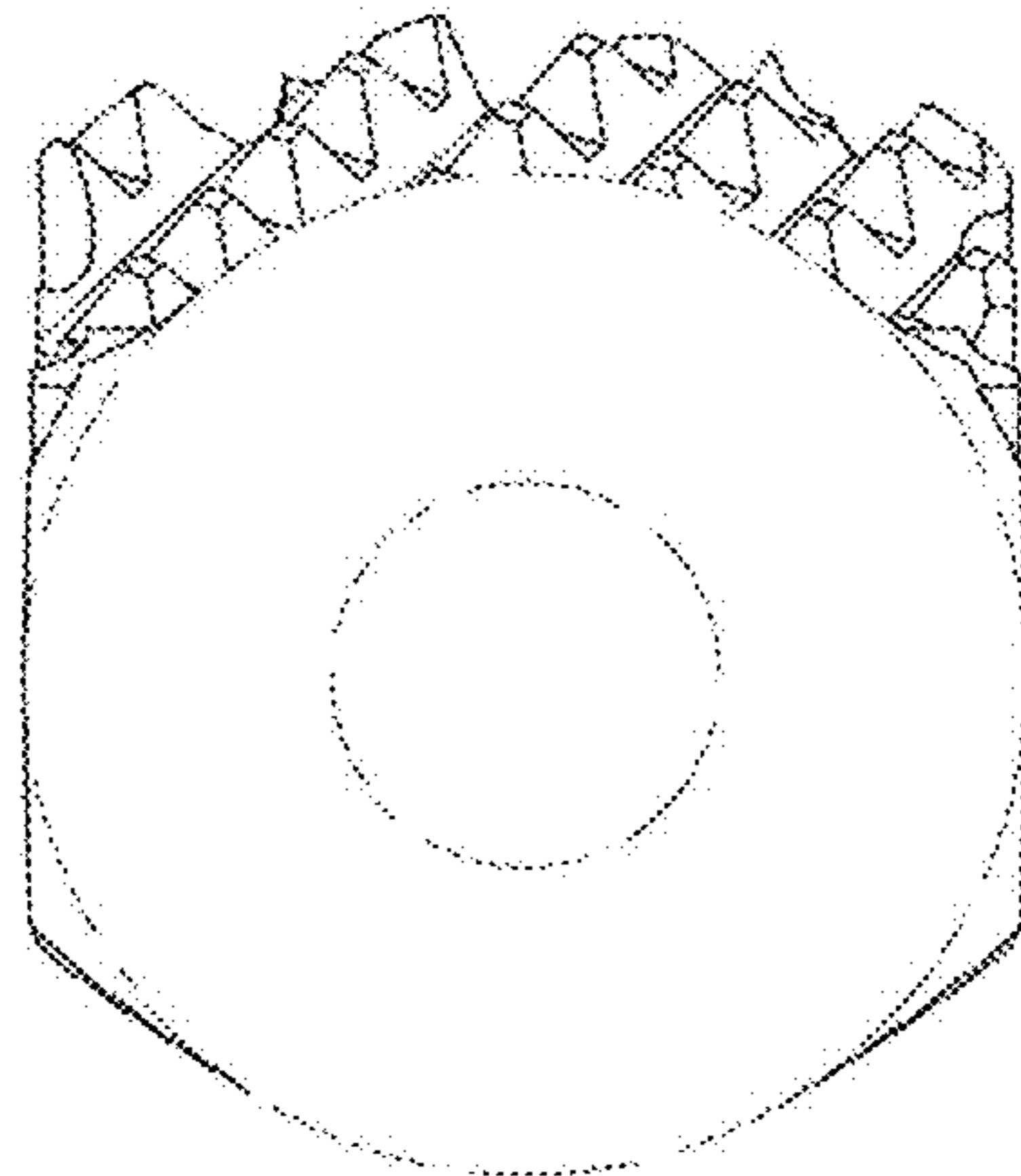

Fig. 7

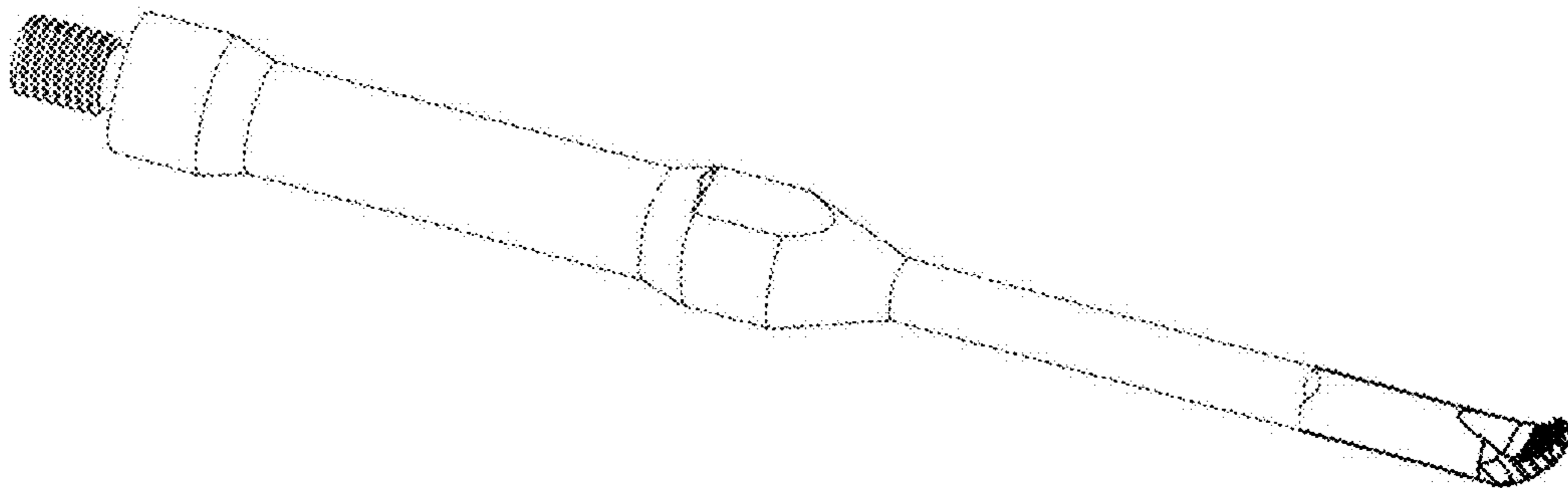

Fig. 8