



US00D882746S

(12) **United States Design Patent**  
**Martouzet**

(10) **Patent No.:** **US D882,746 S**  
(45) **Date of Patent:** **\*\* Apr. 28, 2020**

(54) **AIR PURIFIER**

(71) Applicant: **VALEO SYSTEMES THERMIQUES,**  
Mesnil-St-Denis (FR)

(72) Inventor: **François-Xavier Martouzet,** Bailly  
(FR)

(73) Assignee: **VALEO SYSTEMES THERMIQUES,**  
Mesnil-St-Denis (FR)

(\*\*) Term: **15 Years**

(21) Appl. No.: **29/655,745**

(22) Filed: **Jul. 6, 2018**

(30) **Foreign Application Priority Data**

Jan. 8, 2018 (EP) ..... 004618007

(51) **LOC (12) Cl.** ..... **23-04**

(52) **U.S. Cl.**  
USPC ..... **D23/364**

(58) **Field of Classification Search**

USPC ..... D23/355-366, 352, 369, 332, 333, 335,  
D23/336, 342, 351; 422/120, 122;  
55/356, 473, 504; 96/971; 261/DIG. 17,  
261/DIG. 65, DIG. 88, DIG. 31  
CPC .. A61L 9/16; A61L 9/22; B01D 47/00; B01D  
47/027; B01D 2221/02; B01D 2259/4508;  
B03C 3/155; B03C 3/368; F24F 3/16;  
F24F 13/20; F24F 13/28

See application file for complete search history.

(56) **References Cited**

**U.S. PATENT DOCUMENTS**

D503,221 S \* 3/2005 Miller ..... D23/333  
D517,181 S \* 3/2006 Kang ..... D23/356

D549,307 S \* 8/2007 Chiu ..... D23/333  
D572,351 S \* 7/2008 Lewis ..... D23/317  
D572,352 S \* 7/2008 Chiu ..... D23/333  
D573,241 S \* 7/2008 Chiu ..... D23/359  
D577,800 S \* 9/2008 Yoon ..... D23/359  
D683,439 S \* 5/2013 Choi ..... D23/364  
D699,332 S \* 2/2014 Chiu ..... D23/333  
D723,149 S \* 2/2015 Huang ..... D23/359  
D725,253 S \* 3/2015 Choi ..... D23/359  
D735,845 S \* 8/2015 Huang ..... D23/359  
D810,259 S \* 2/2018 You ..... D23/364

\* cited by examiner

*Primary Examiner* — David G Muller

(74) *Attorney, Agent, or Firm* — Buchanan Ingersoll &  
Rooney PC

(57) **CLAIM**

The ornamental design for an air purifier, as shown and described.

**DESCRIPTION**

FIG. 1 is a front, left perspective view of an air purifier showing my new design;  
FIG. 2 is a front elevational view thereof;  
FIG. 3 is a rear elevational view thereof;  
FIG. 4 is a left side elevational view thereof;  
FIG. 5 is a right side elevational view thereof;  
FIG. 6 is a top plan view thereof; and,  
FIG. 7 is a bottom plan view thereof.

**1 Claim, 6 Drawing Sheets**

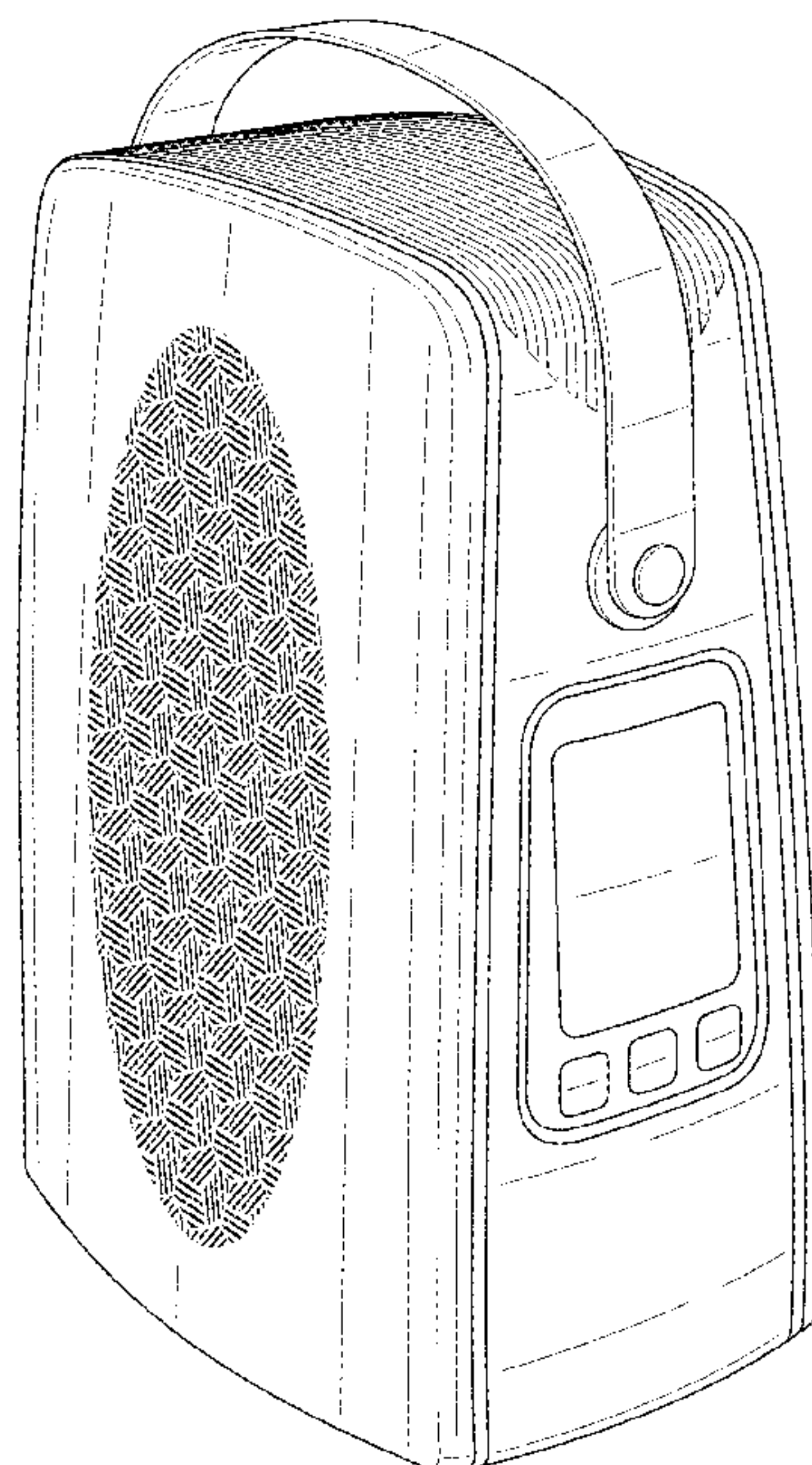

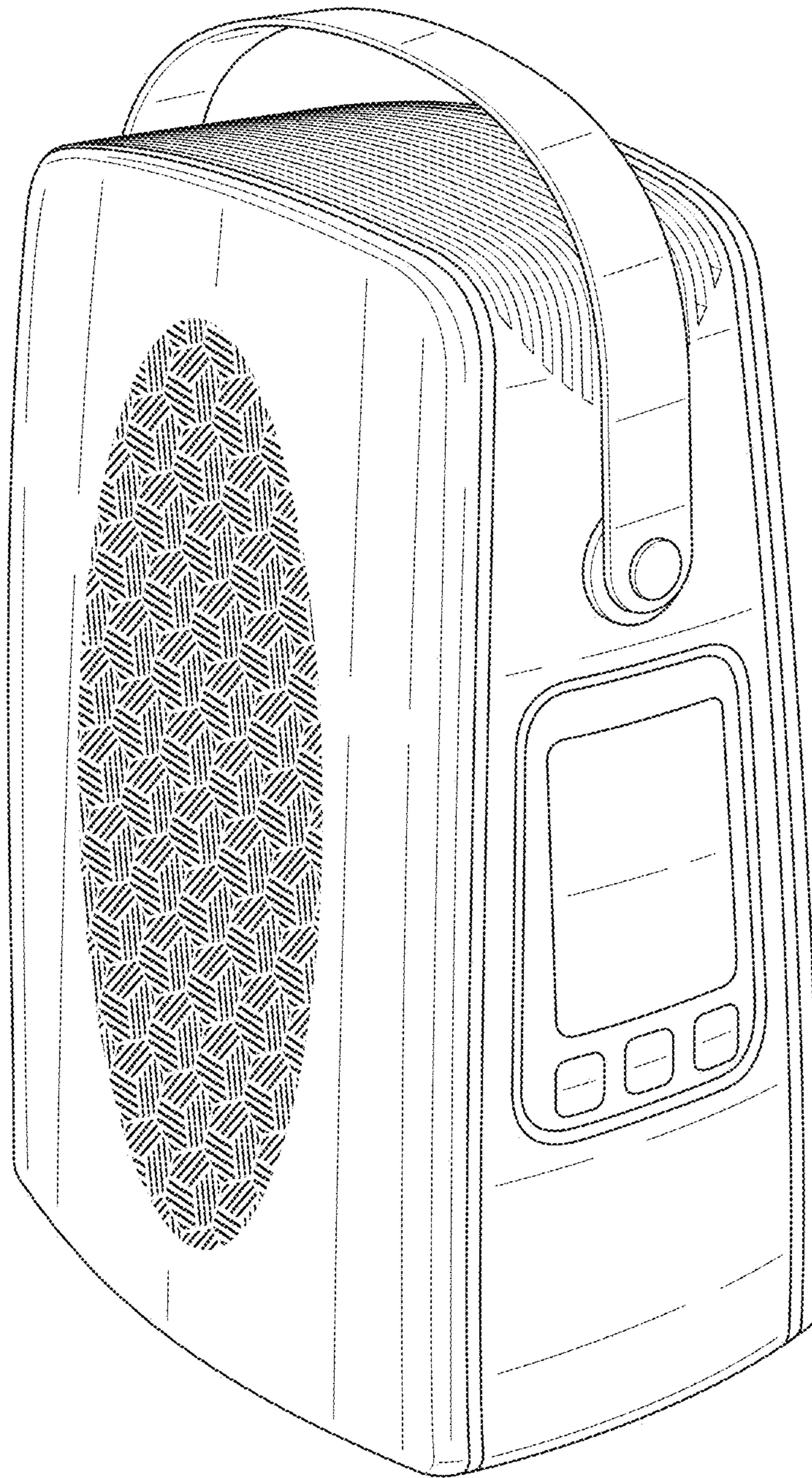

FIG. 1



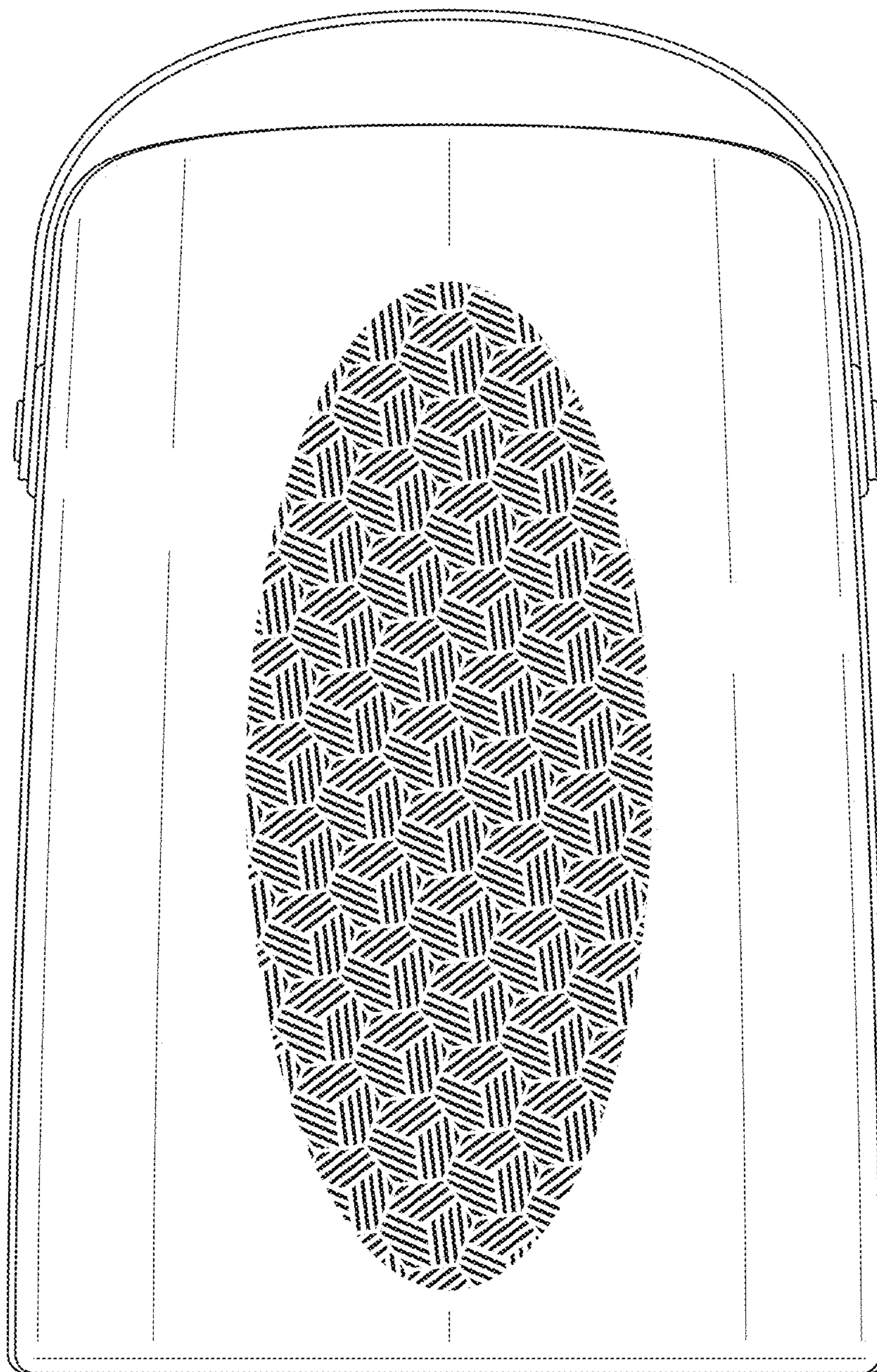

FIG. 2

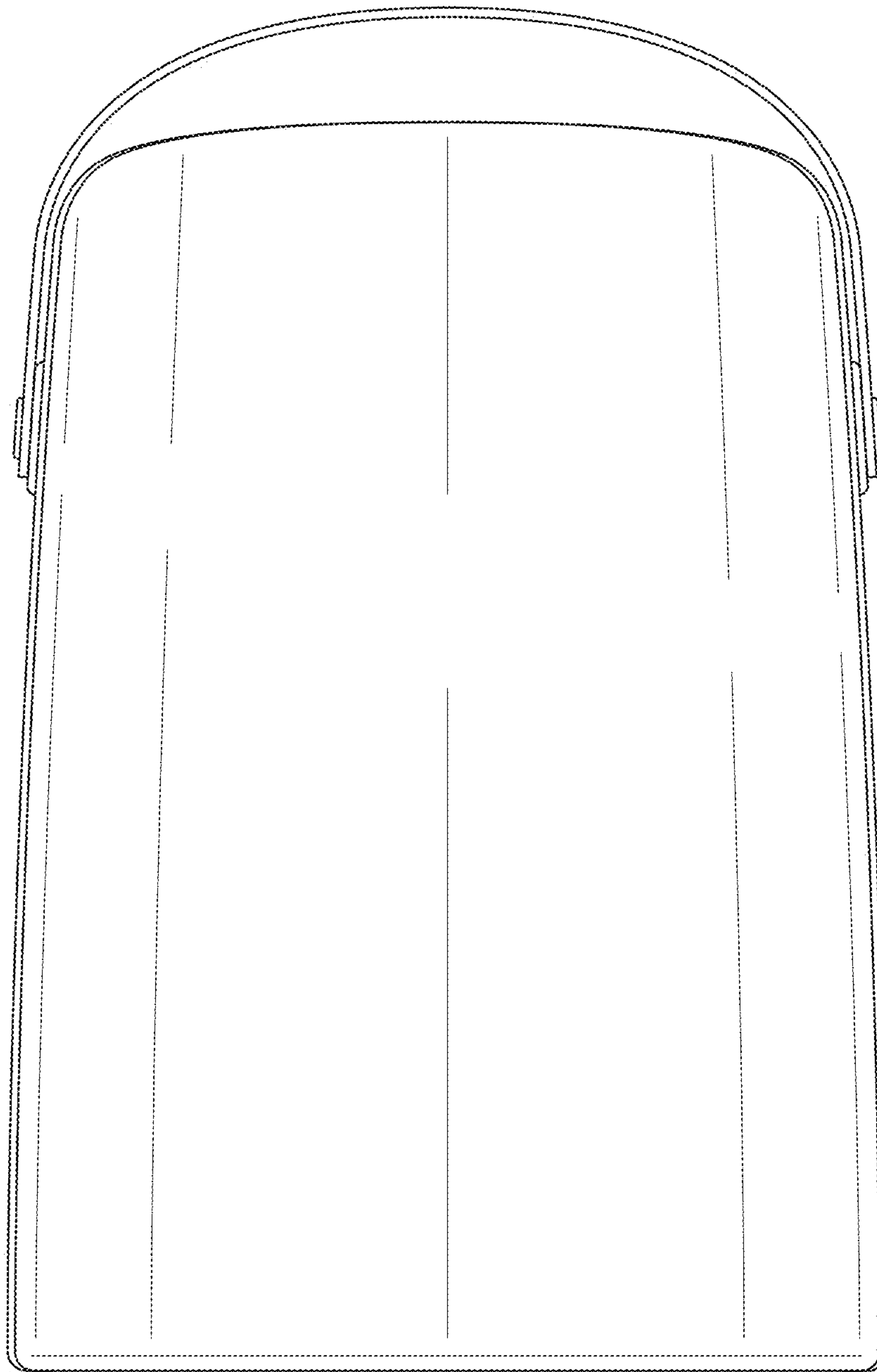

FIG. 3

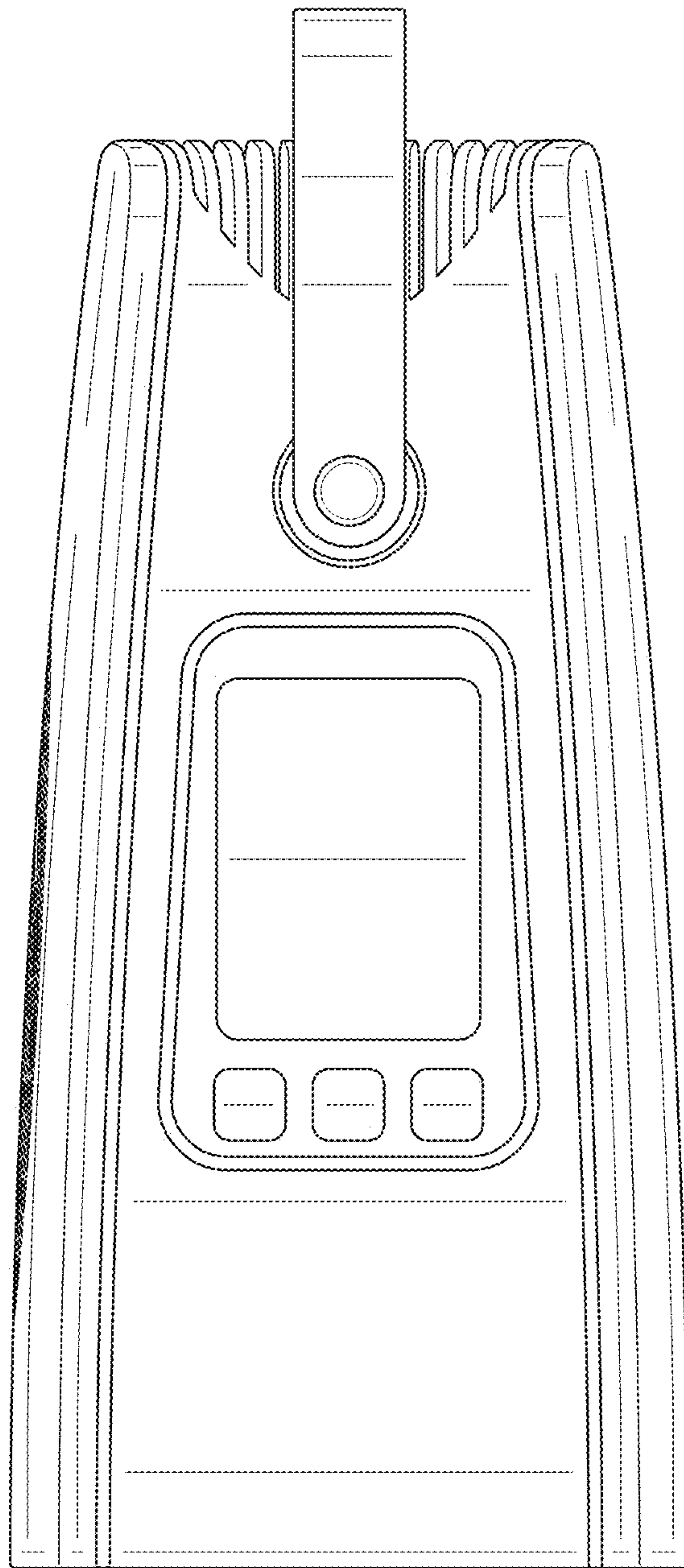

FIG. 4

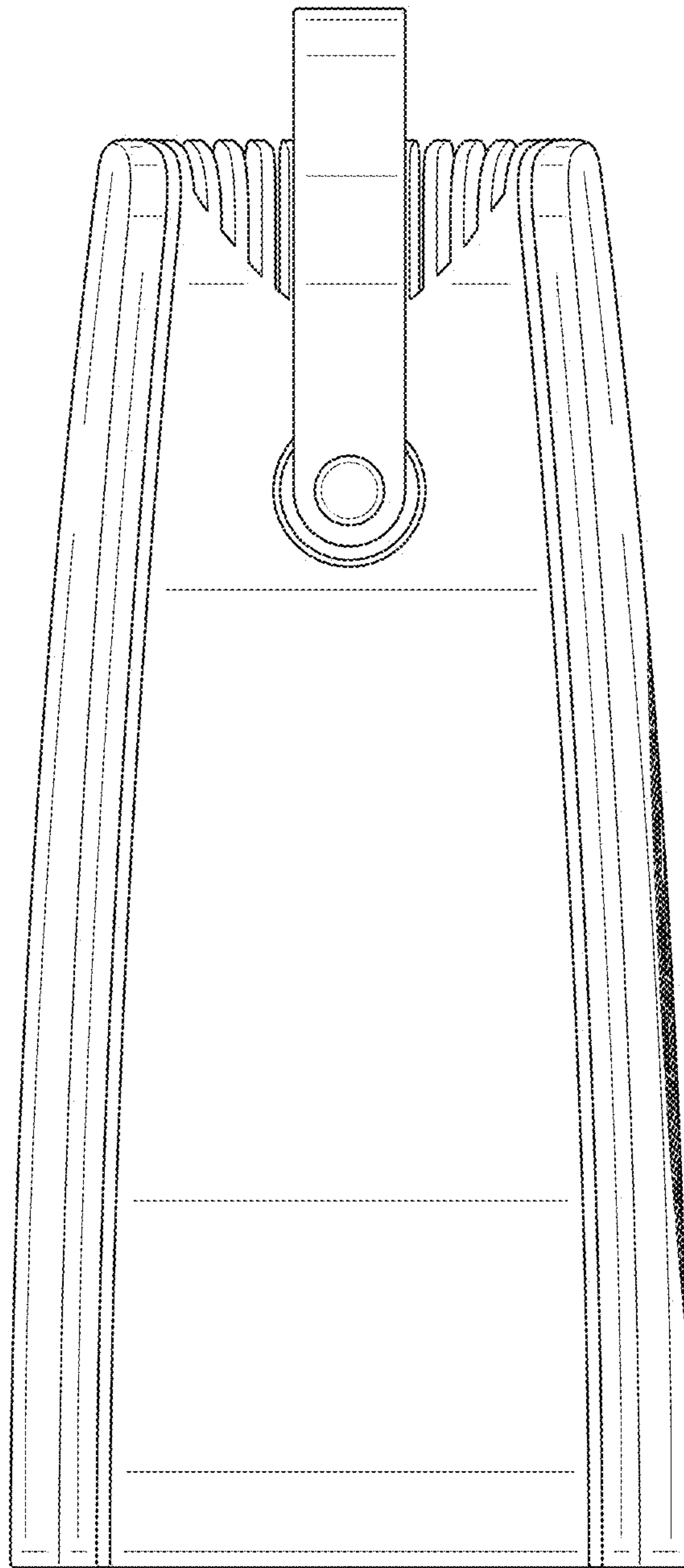

FIG. 5



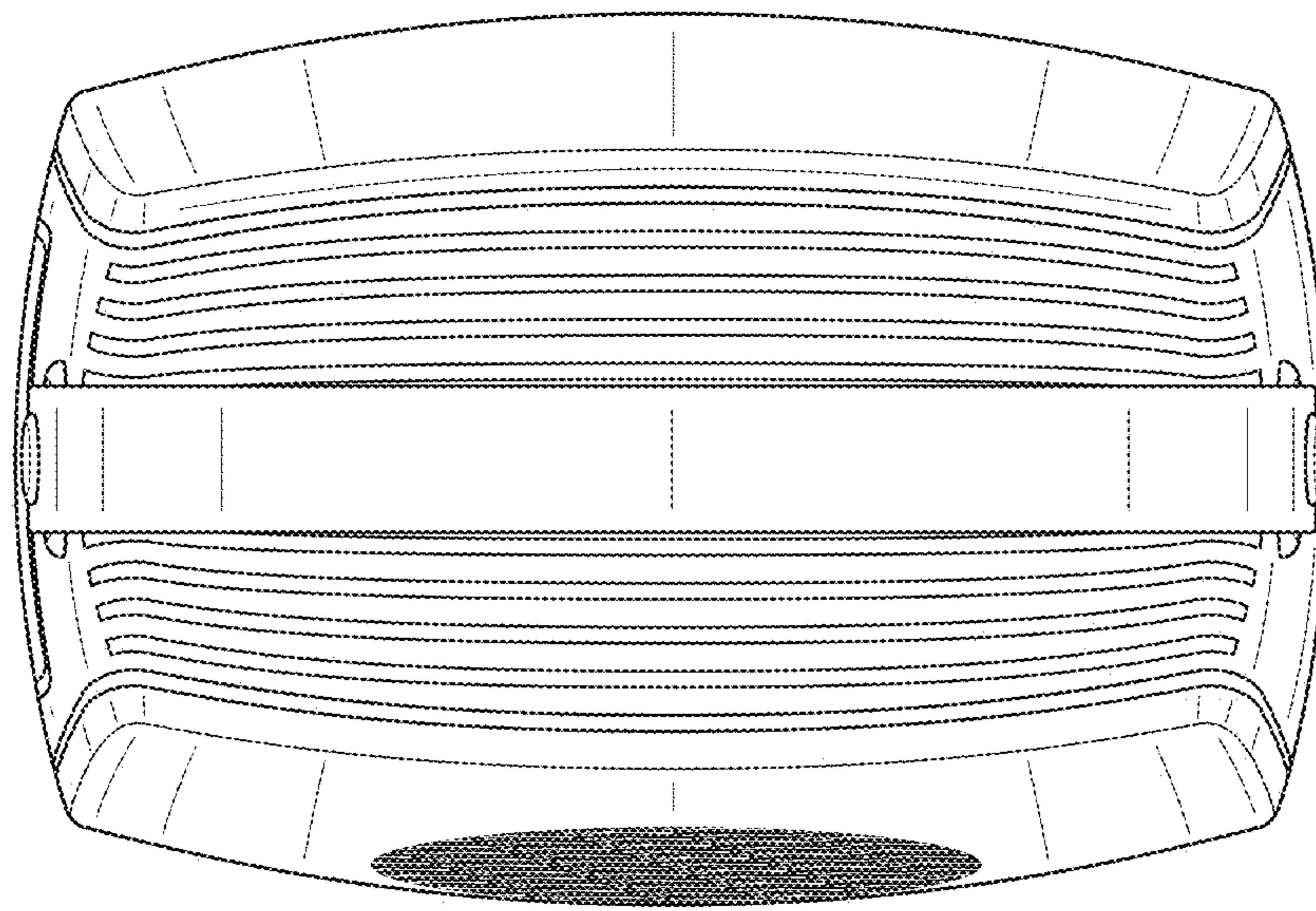

FIG. 6

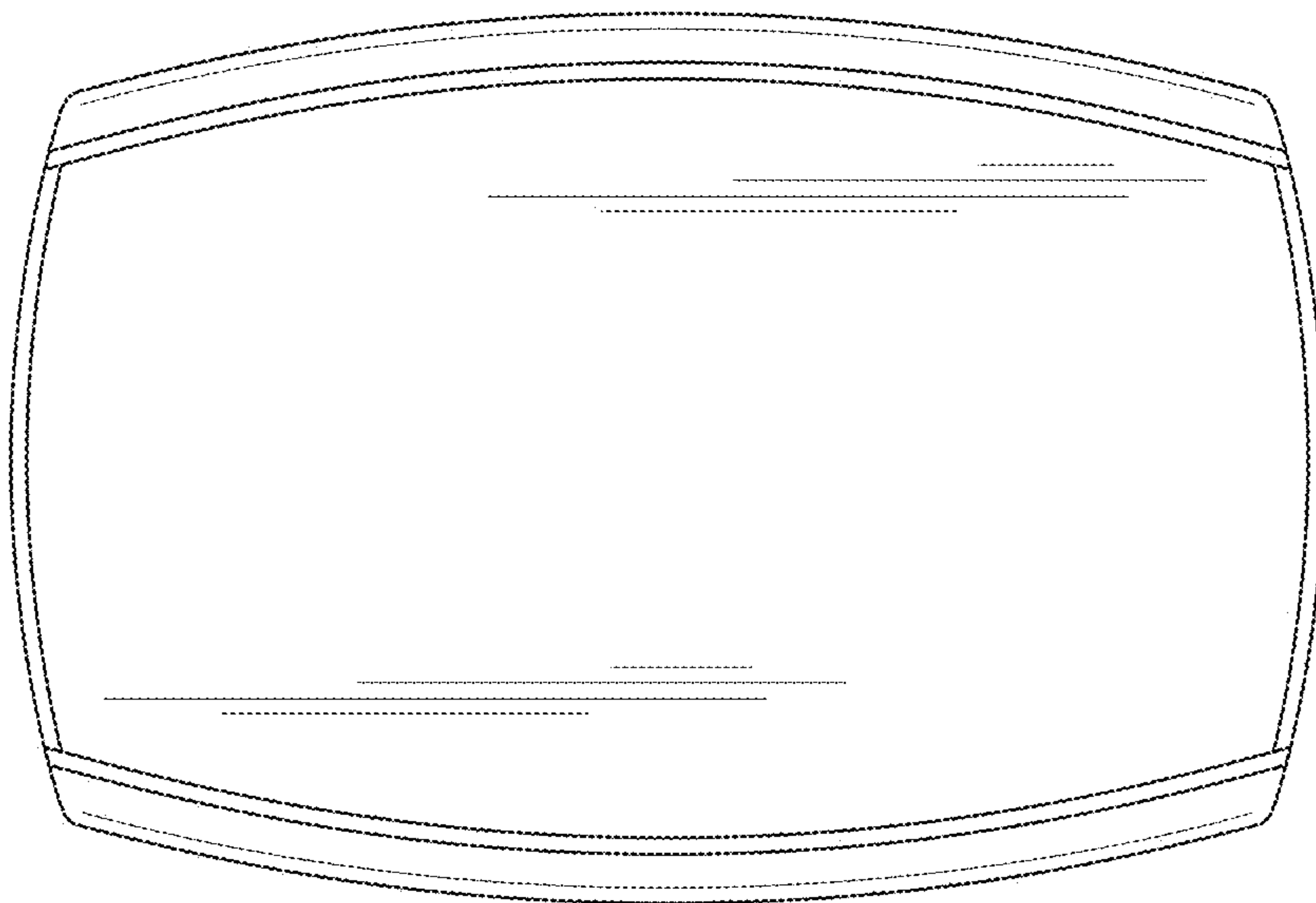

FIG. 7