



US00D882569S

(12) **United States Design Patent**  
**Tsao**

(10) **Patent No.:** **US D882,569 S**

(45) **Date of Patent:** **\*\* Apr. 28, 2020**

(54) **HEAD MOUNTING FRAME OF HEAD MOUNTED DISPLAY**

(71) Applicant: **Acer Incorporated**, New Taipei (TW)

(72) Inventor: **Jung-Wei Tsao**, New Taipei (TW)

(73) Assignee: **Acer Incorporated**, New Taipei (TW)

(\*\*) Term: **15 Years**

(21) Appl. No.: **29/673,215**

(22) Filed: **Dec. 12, 2018**

(30) **Foreign Application Priority Data**

Aug. 28, 2018 (TW) ..... 107305076

(51) **LOC (12) Cl.** ..... **14-02**

(52) **U.S. Cl.**  
USPC ..... **D14/372**

(58) **Field of Classification Search**  
USPC ..... D14/372, 496, 432, 371, 125, 126, 129,  
D14/299; D16/300-342; 351/158, 153,  
351/144; 345/7-9, 905; 455/344;  
348/115, 53, 121, 739  
CPC ..... G02B 27/017; G02B 27/0158; G02B  
27/0161; G02B 27/0181; G02B 27/0185;  
G02B 27/0189  
See application file for complete search history.

(56) **References Cited**

**U.S. PATENT DOCUMENTS**

D798,862 S \* 10/2017 Wang ..... D14/372  
D805,071 S \* 12/2017 Park ..... D14/372  
D807,356 S \* 1/2018 Chou ..... D14/372  
D807,357 S \* 1/2018 Wu ..... D14/372

D810,081 S \* 2/2018 Lin ..... D14/372  
D810,743 S \* 2/2018 Yee ..... D14/372  
D838,718 S \* 1/2019 Chiang ..... D14/372  
D844,605 S \* 4/2019 Yeh ..... D14/372  
D849,003 S \* 5/2019 Chiang ..... D14/372  
D860,200 S \* 9/2019 McGinty, Jr. .... D14/372  
D865,763 S \* 11/2019 Lau ..... D14/372  
D866,552 S \* 11/2019 Young ..... D14/372  
D870,727 S \* 12/2019 Nie ..... D14/372

\* cited by examiner

*Primary Examiner* — Austin Murphy

(74) *Attorney, Agent, or Firm* — JCIPRNET

(57) **CLAIM**

The ornamental design for a head mounting frame of head mounted display, as shown and described.

**DESCRIPTION**

FIG. 1 is a perspective view of a head mounting frame of head mounted display showing my new design; FIGS. 2-8 are different perspective views of the head mounting frame respectively; FIG. 9 is a front view thereof; FIG. 10 is a rear view thereof; FIG. 11 is a left side view thereof; FIG. 12 is a right side view thereof; FIG. 13 is a top view thereof; FIG. 14 is a bottom view thereof; and, FIGS. 15-16 are different perspective views showing a head mounted display being worn on a user's head by the head mounting frame.

The broken line portions of the head mounting frame of head mounted display in FIGS. 15-16 represent unclaimed portions of the claimed design and form no part thereof.

**1 Claim, 16 Drawing Sheets**

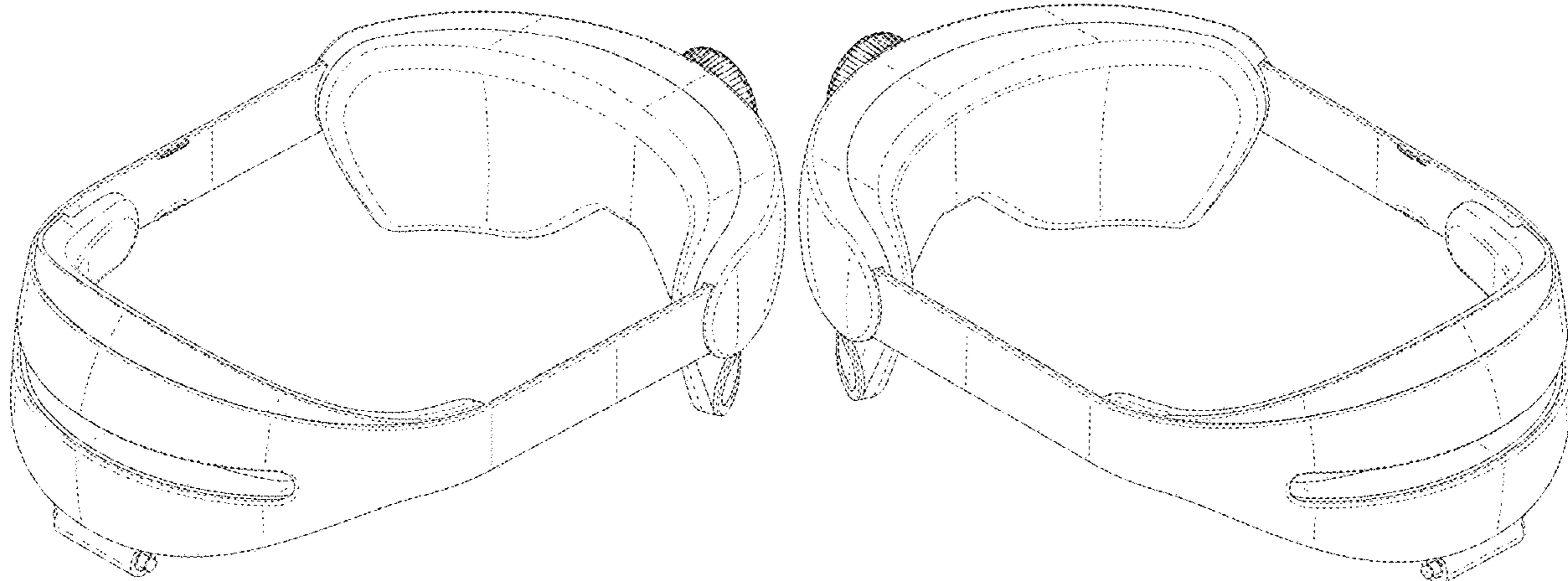

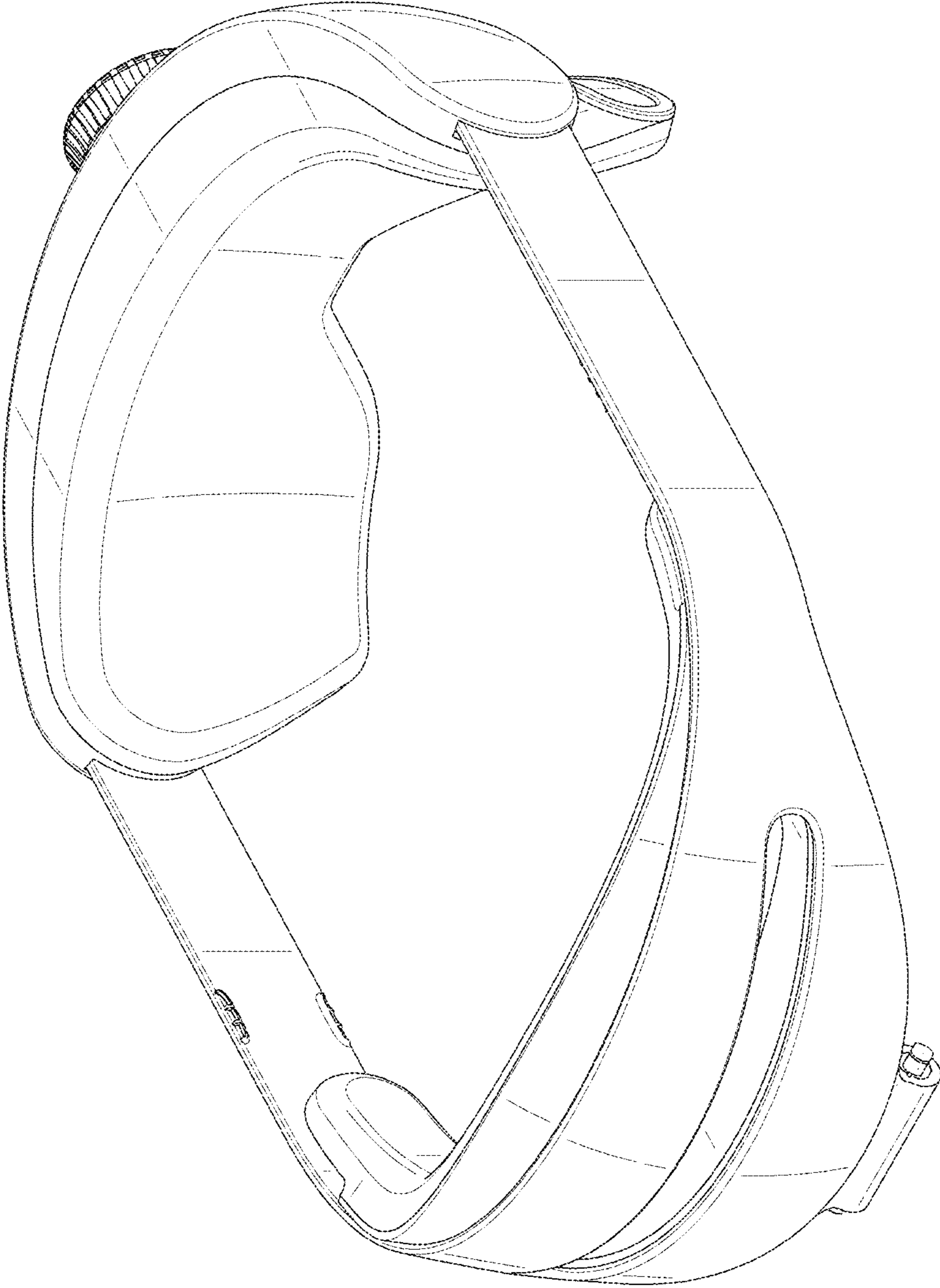

FIG. 1

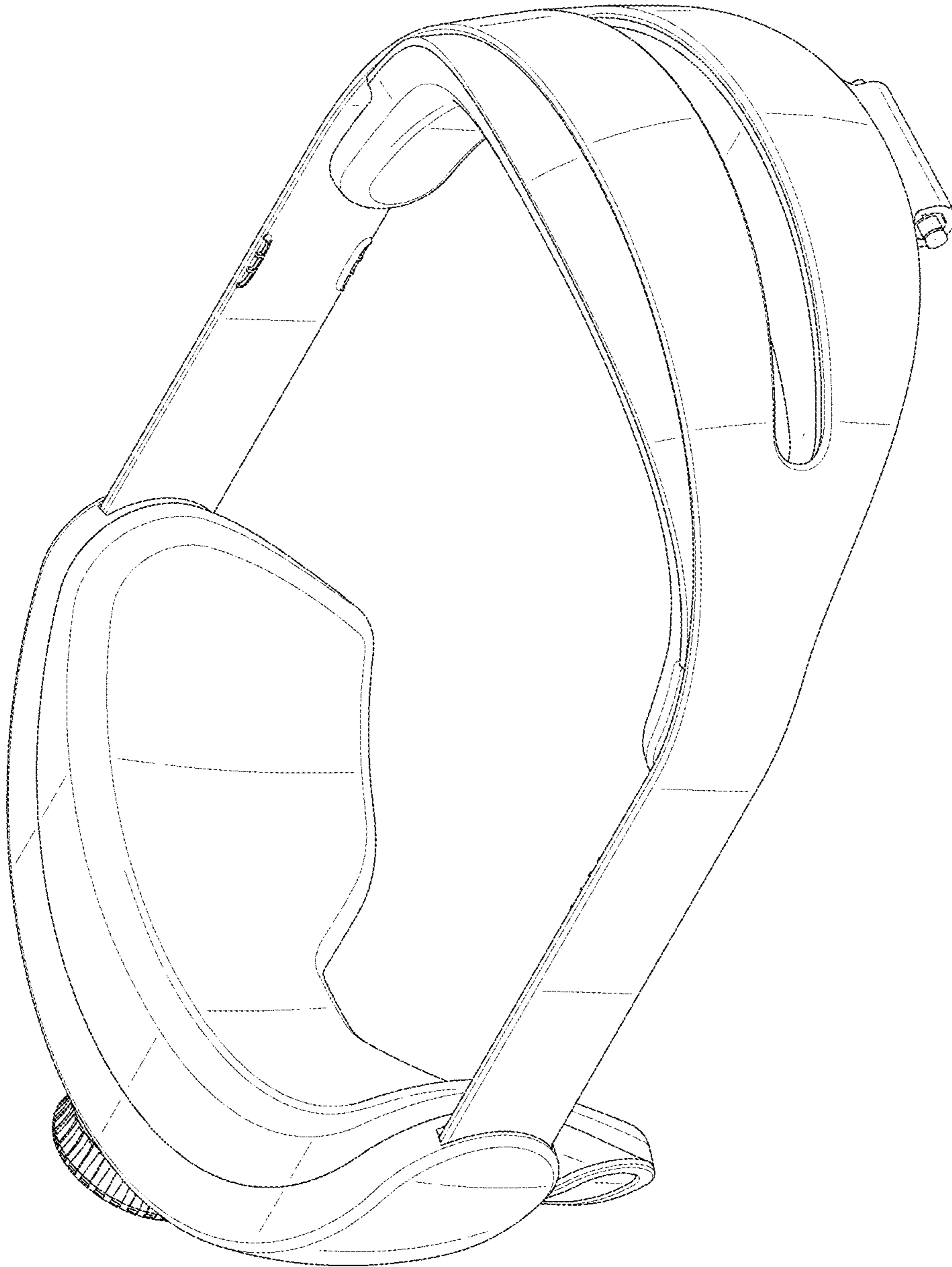

FIG. 2

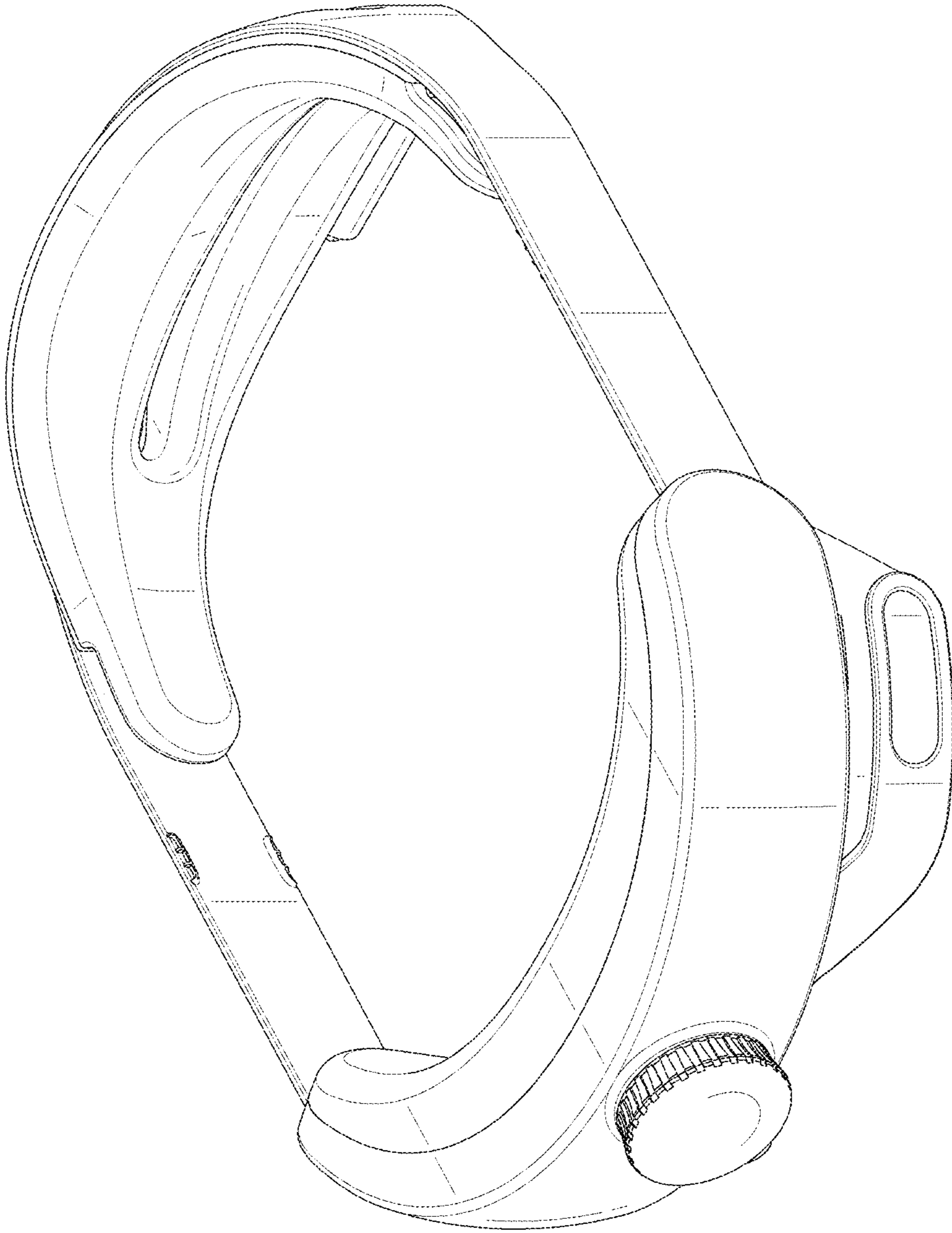

FIG. 3

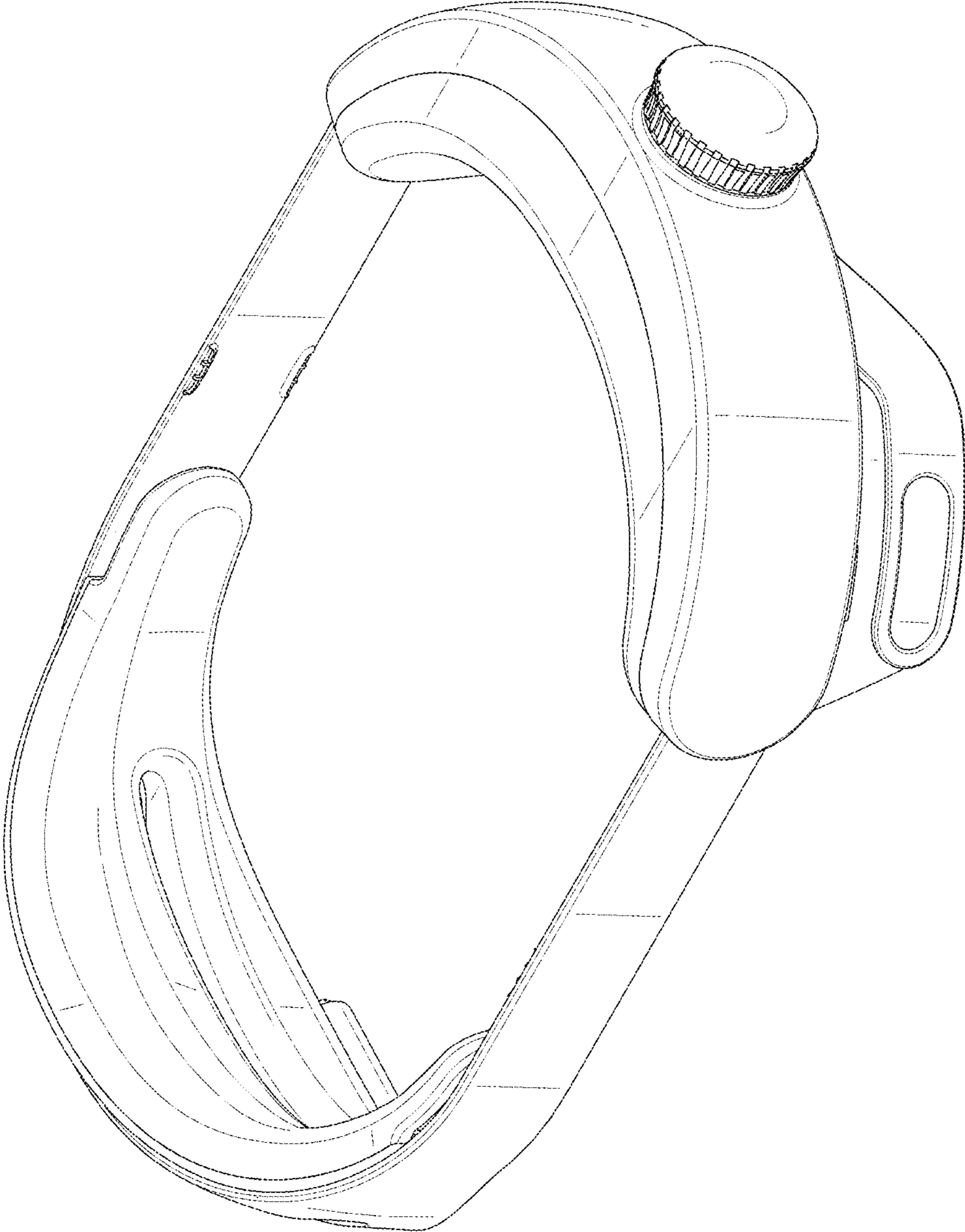

FIG. 4

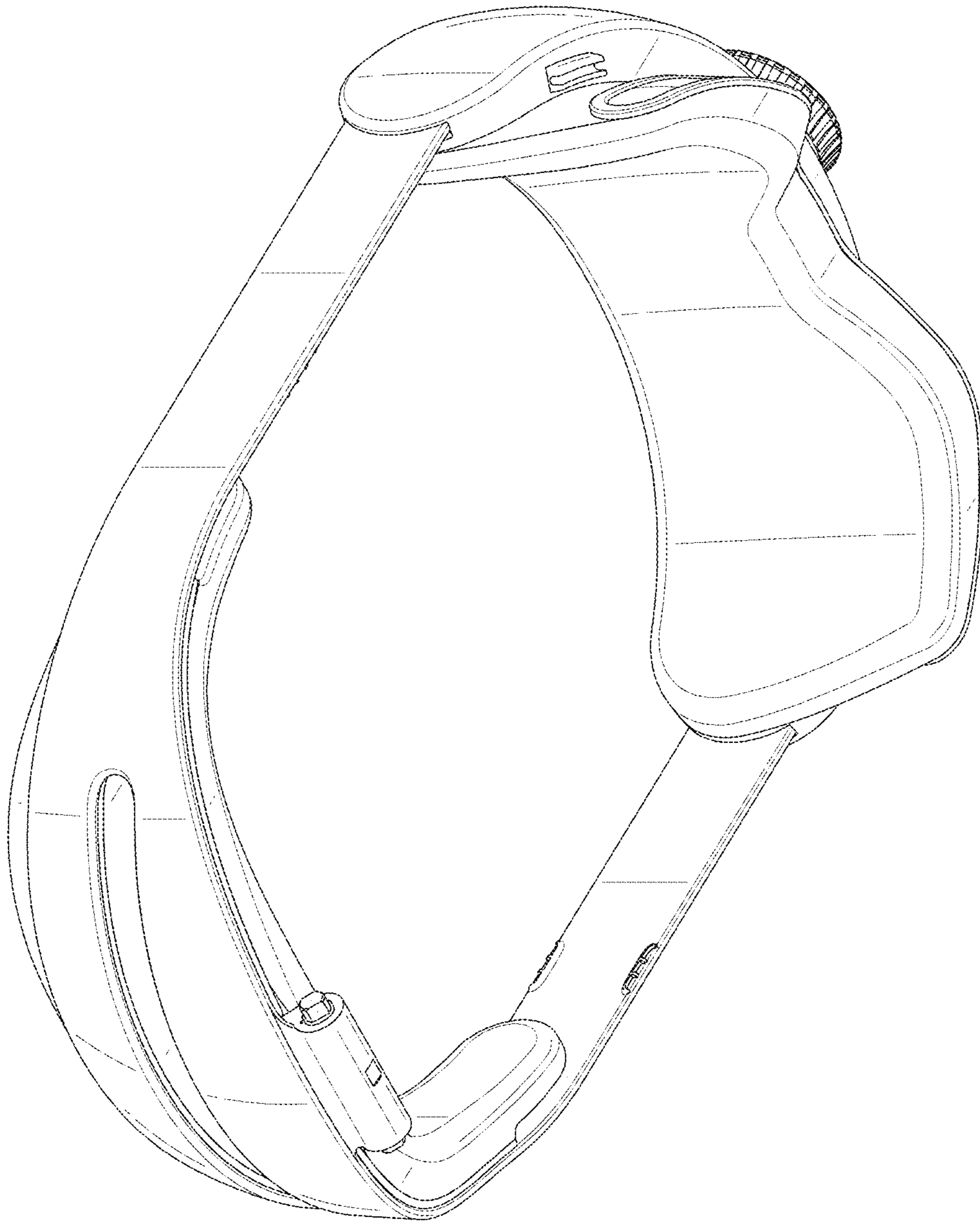

FIG. 5

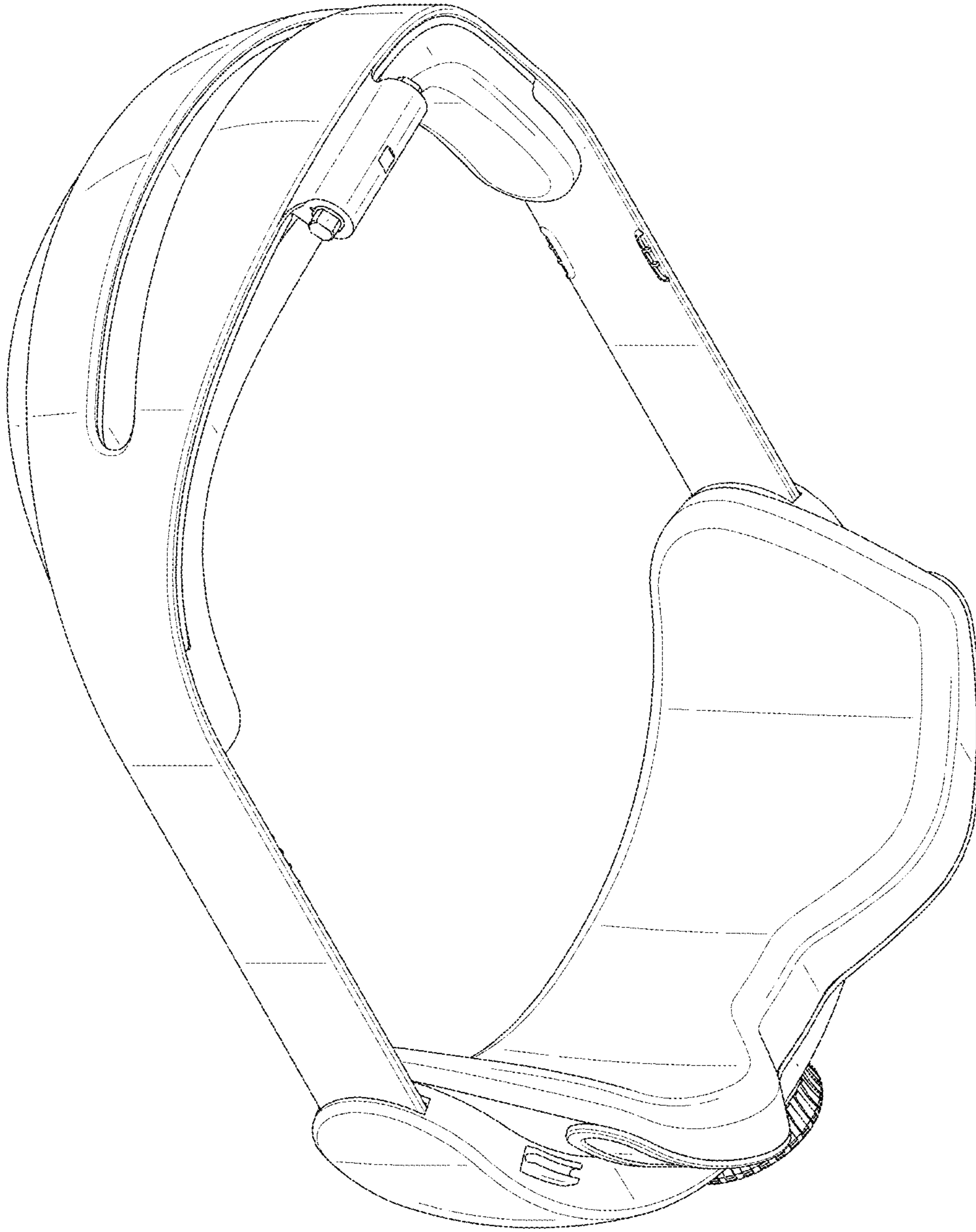

FIG. 6

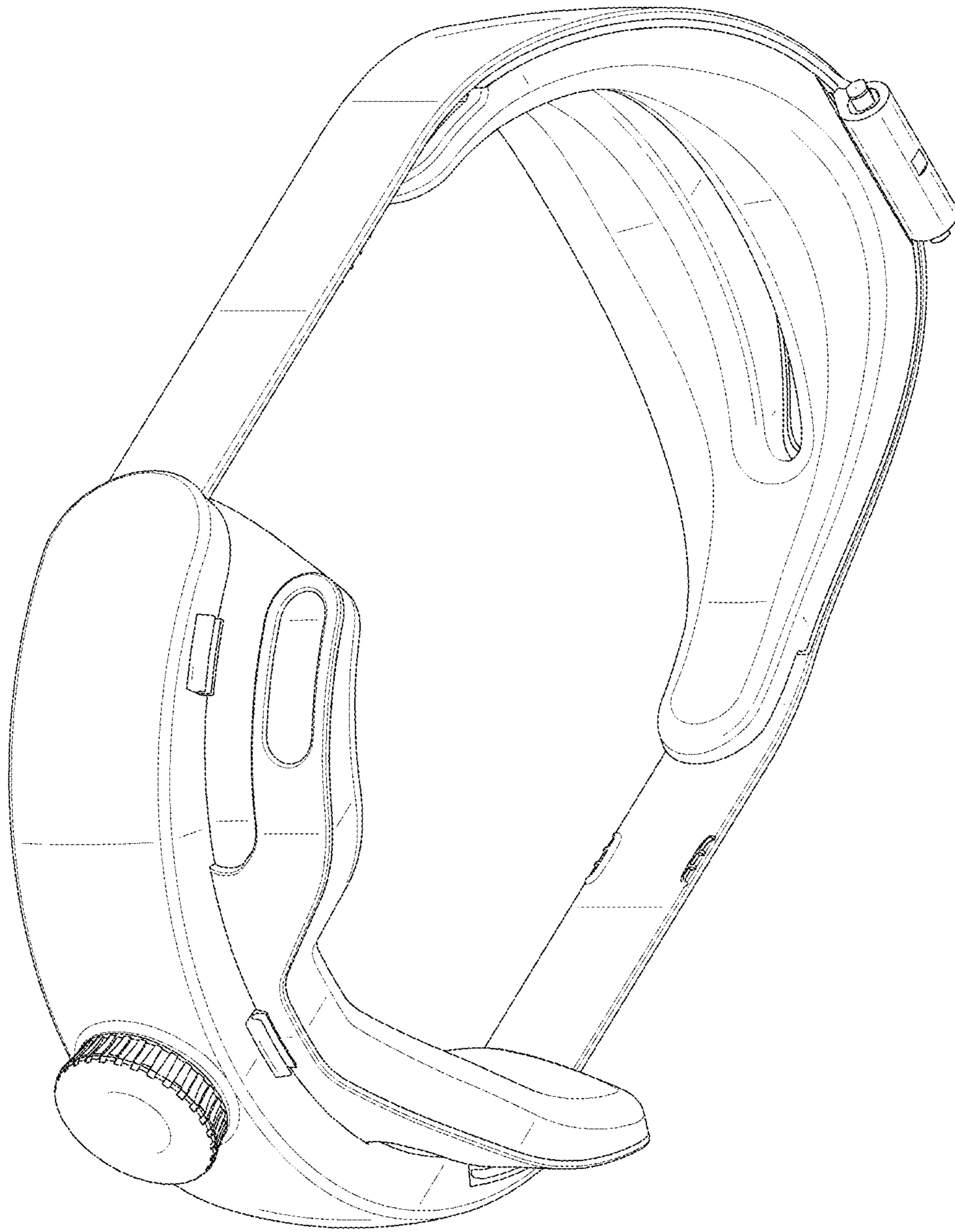

FIG. 7



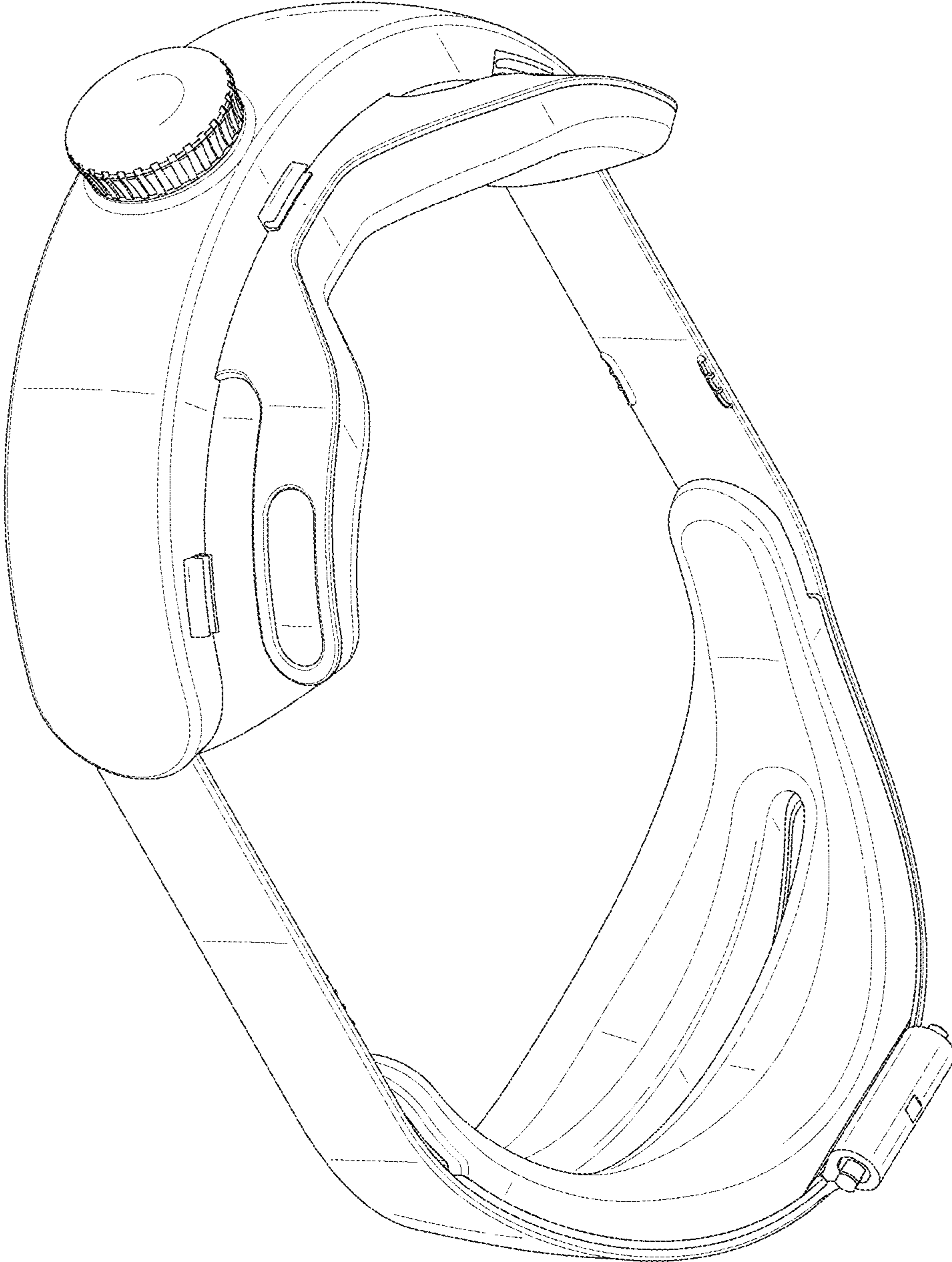

FIG. 8

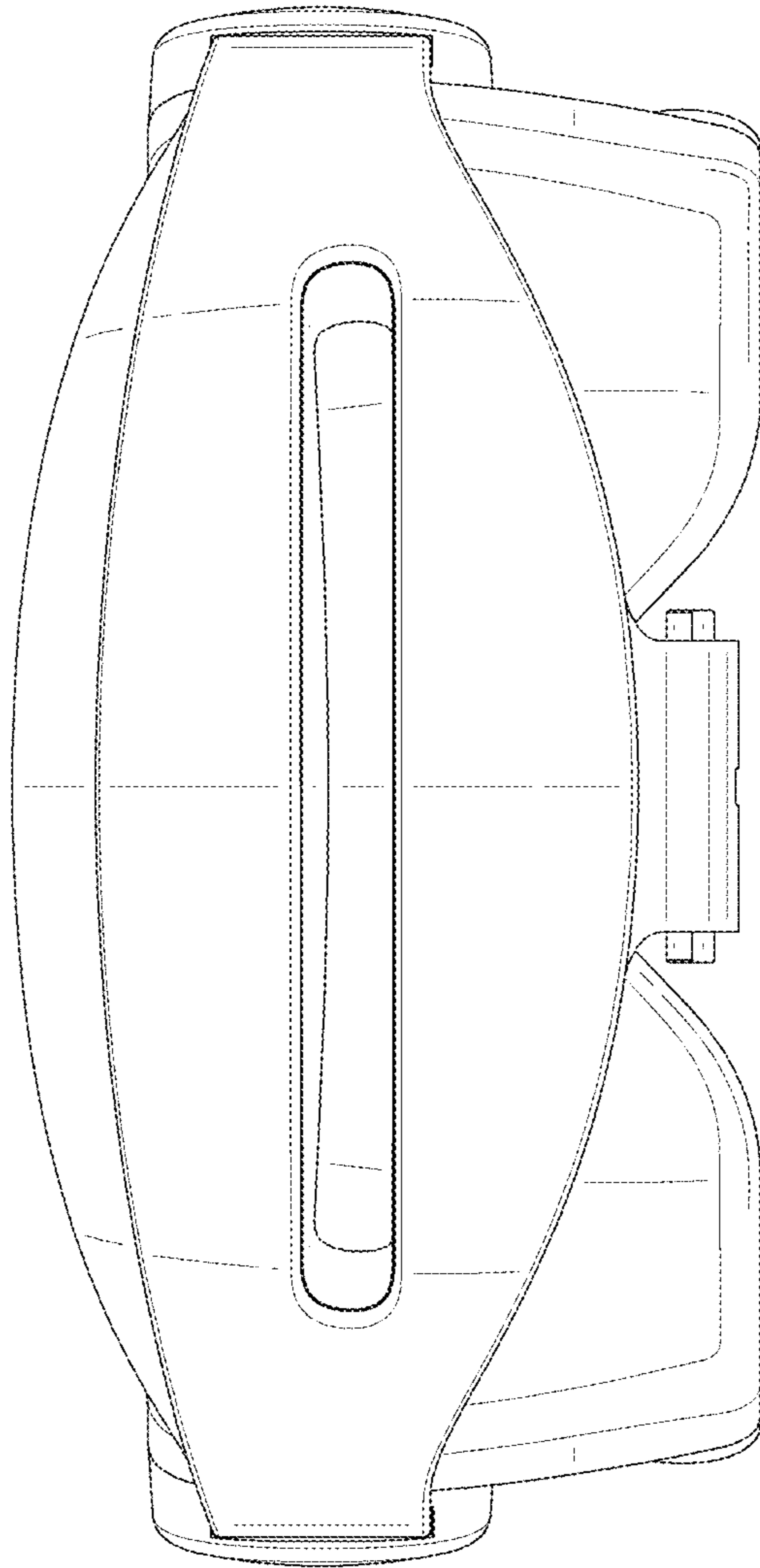

FIG. 9

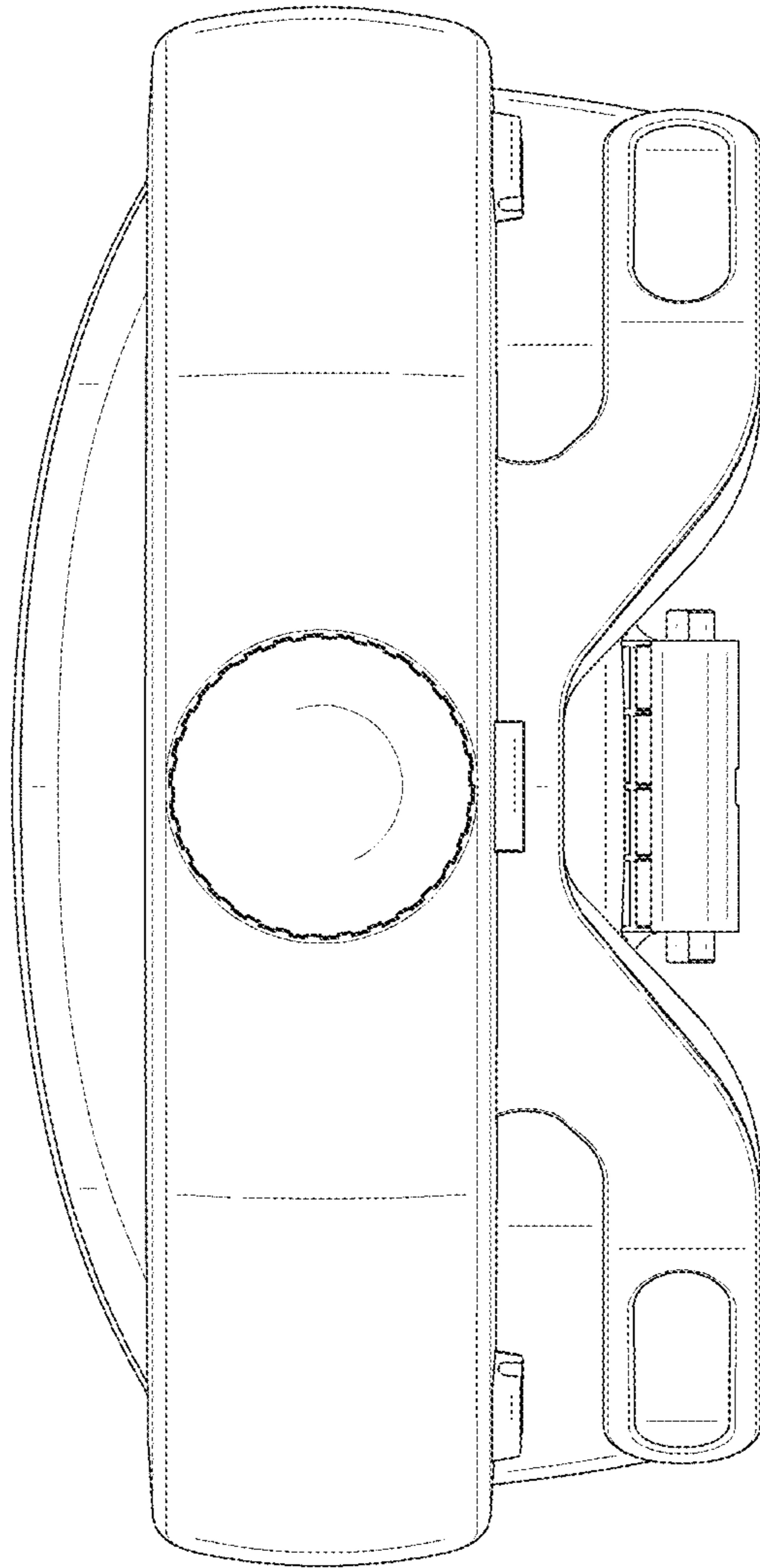

FIG. 10

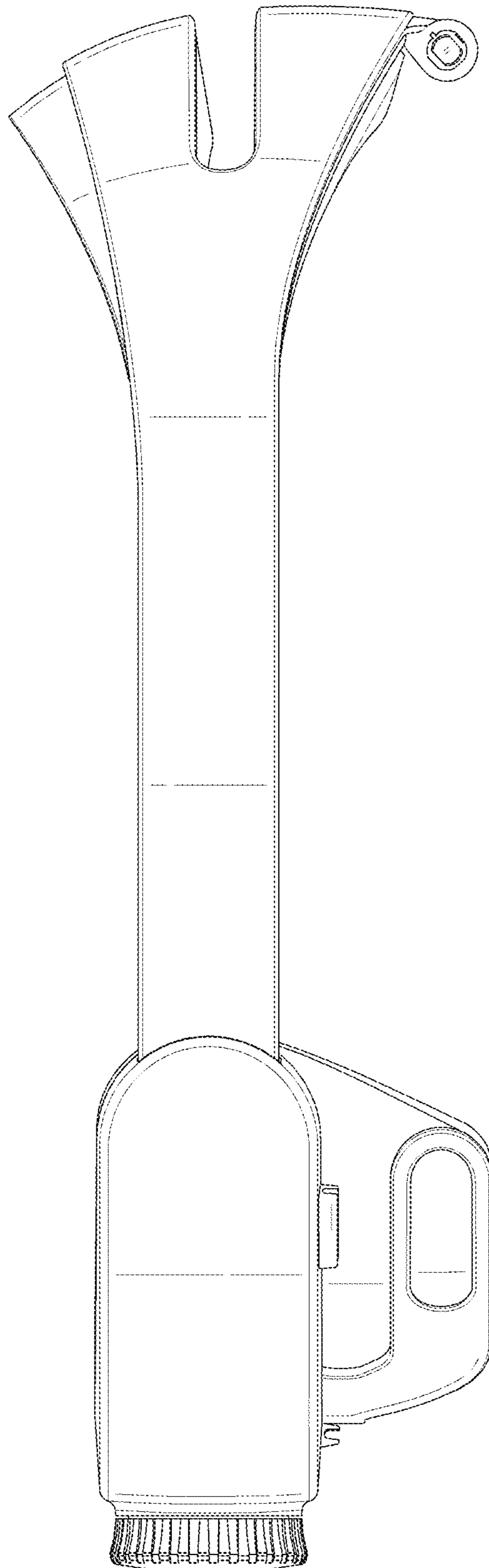

FIG. 11

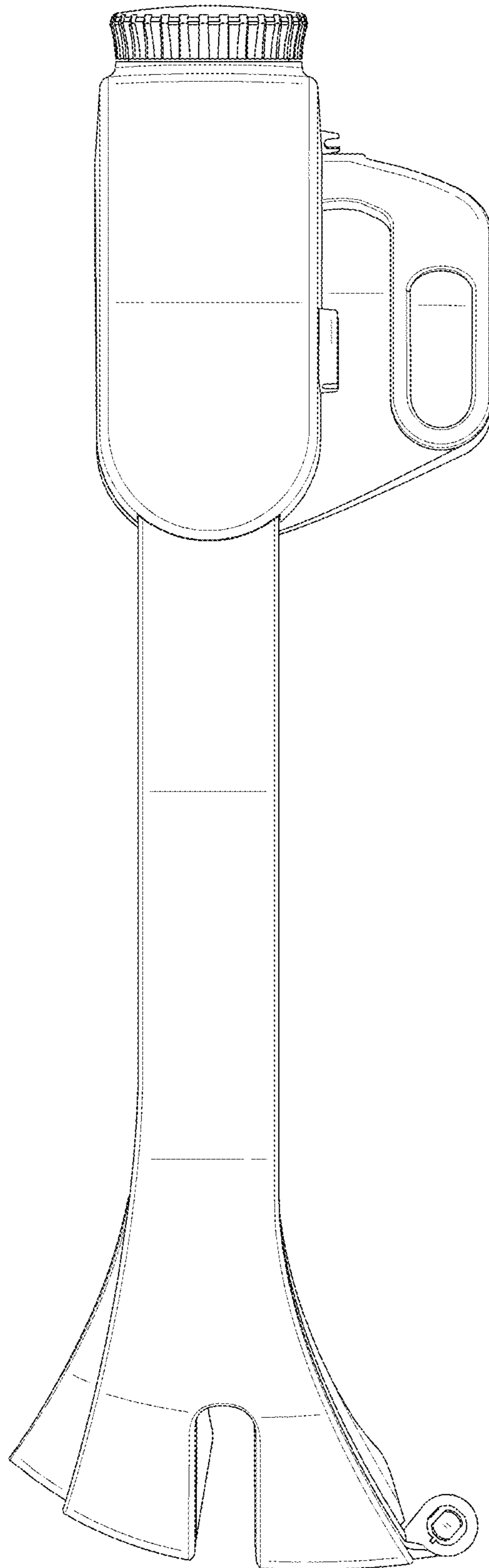

FIG. 12

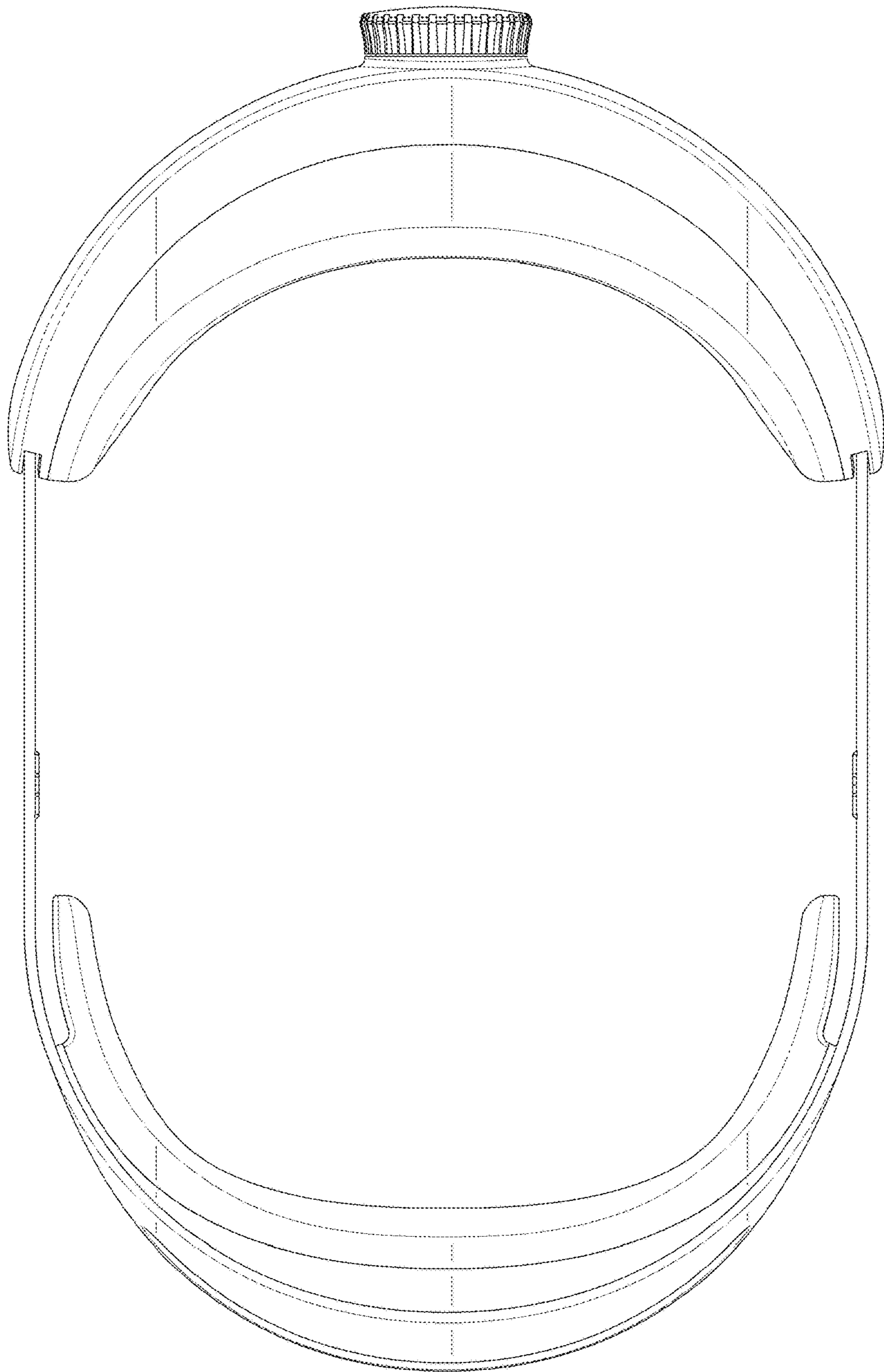

FIG. 13

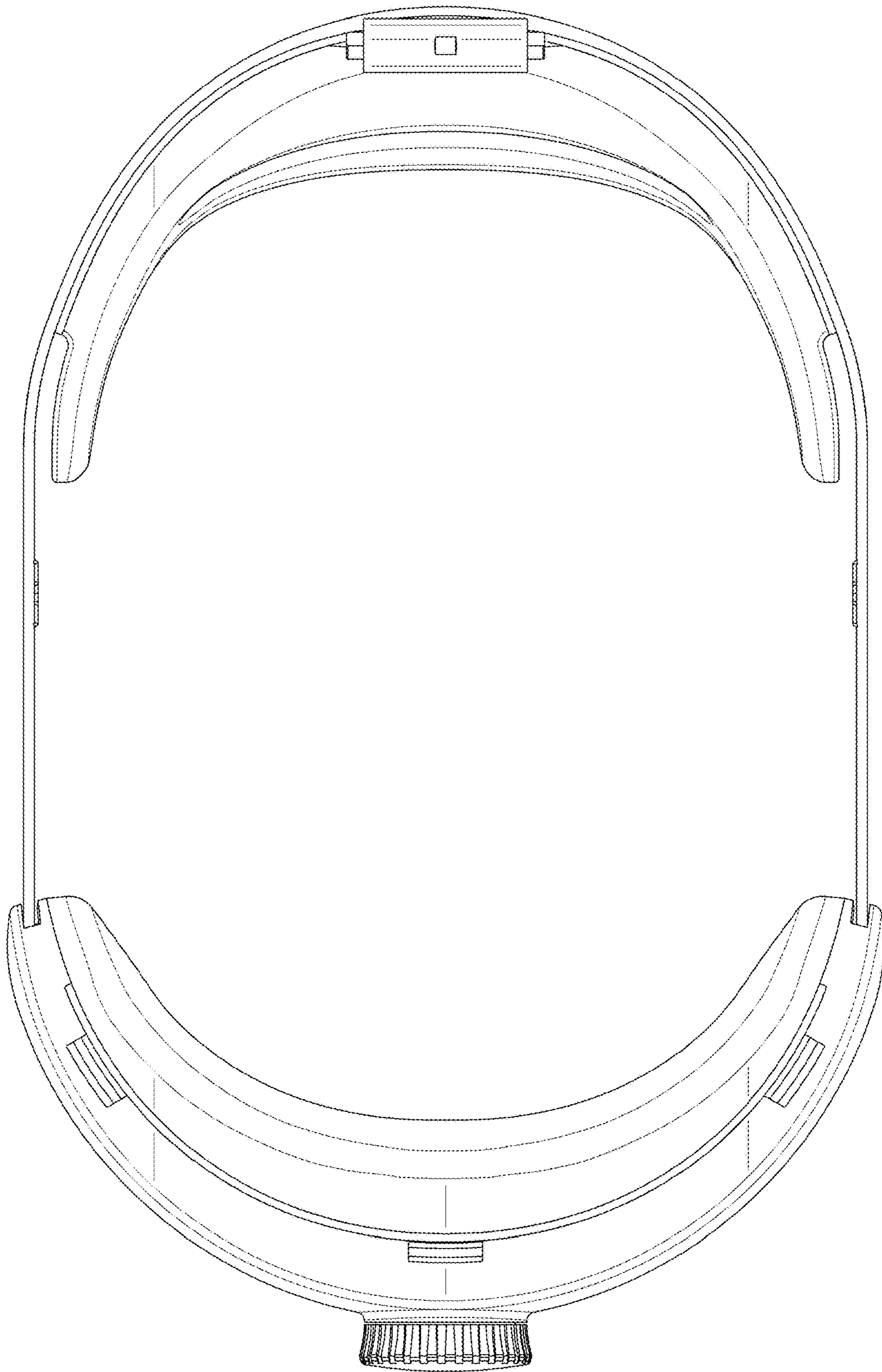

FIG. 14

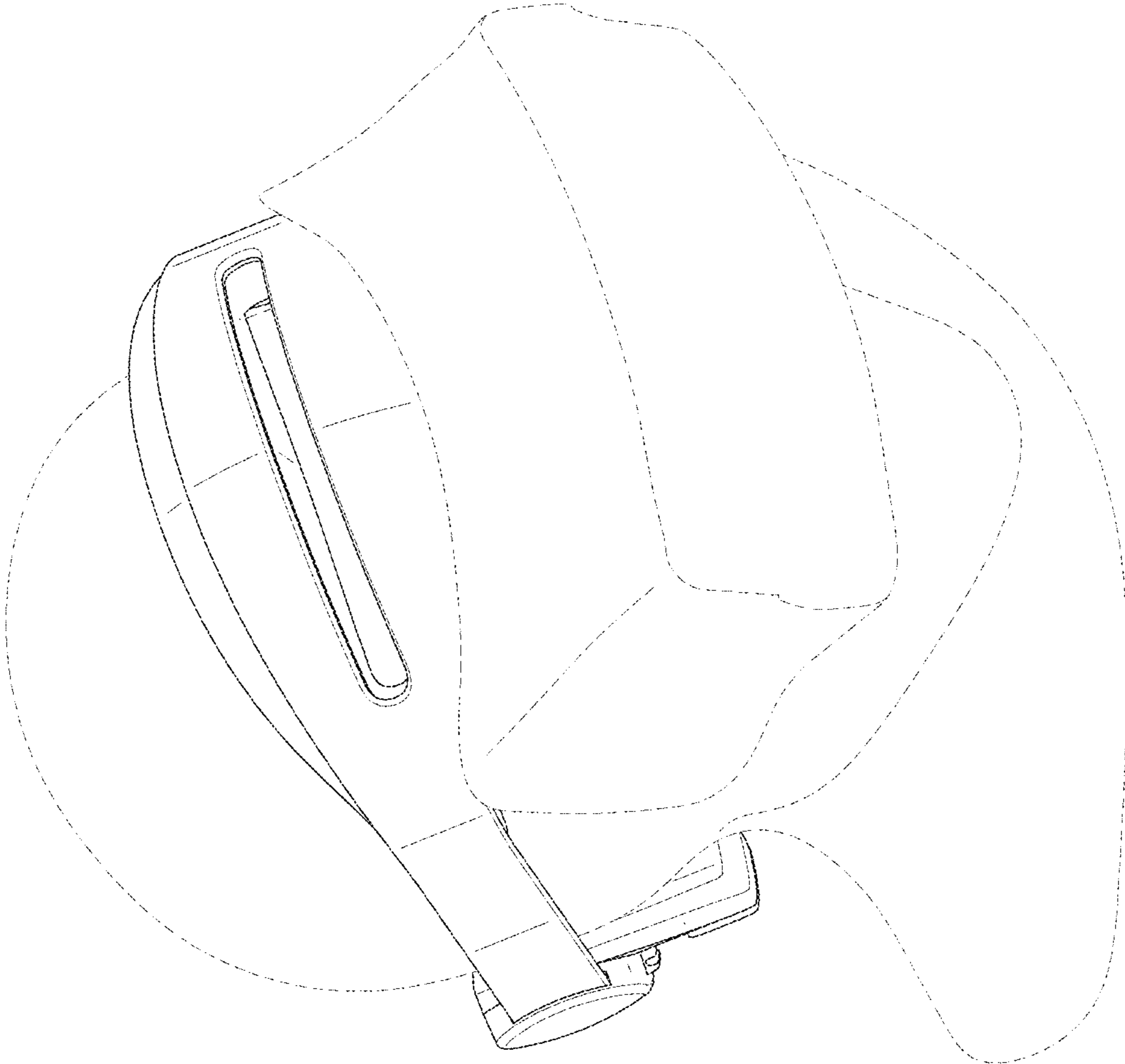

FIG. 15



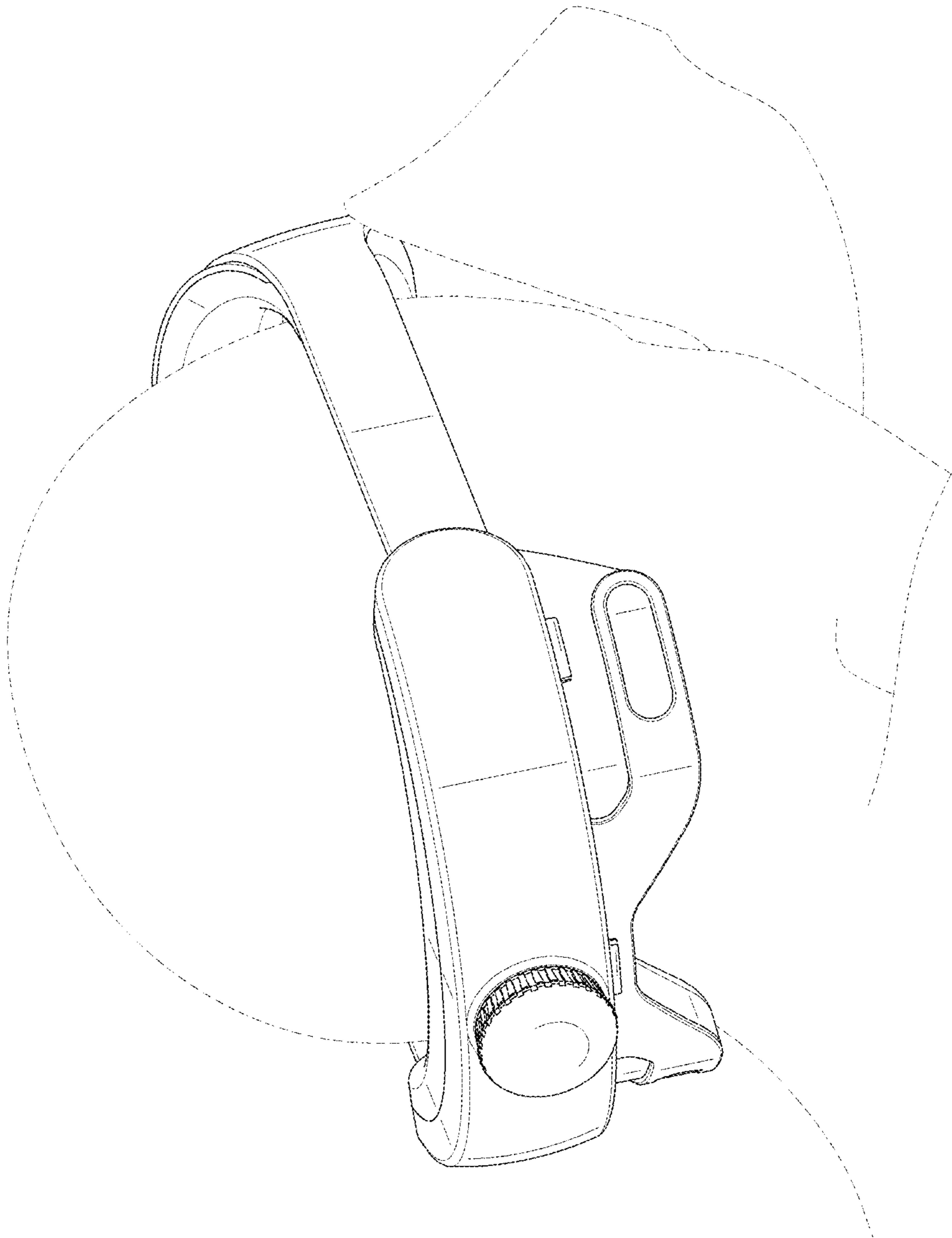

FIG. 16