



US00D882451S

(12) **United States Design Patent**  
**Gurung**

(10) **Patent No.:** **US D882,451 S**

(45) **Date of Patent:** **\*\* Apr. 28, 2020**

(54) **PENDANT**

(71) Applicant: **Tasaki & Co., Ltd.**, Kobe (JP)

(72) Inventor: **Prabal Gurung**, New York, NY (US)

(73) Assignee: **Tasaki & Co., Ltd.**, Kobe (JP)

(\*\*) Term: **15 Years**

(21) Appl. No.: **29/650,073**

(22) Filed: **Jun. 4, 2018**

(51) **LOC (12) Cl.** ..... **11-01**

(52) **U.S. Cl.**  
USPC ..... **D11/79**

(58) **Field of Classification Search**

USPC ..... D11/1, 2, 3, 7, 8, 40, 41, 42, 43, 44, 45,  
D11/48, 63, 67, 79, 81, 84, 78, 26, 27,  
D11/34, 4, 6, 9, 10, 11, 12, 13, 14, 15,  
D11/16, 17, 202, 209

CPC .. A44C 1/00; A44C 3/008; A44C 3/00; A44C  
3/001; A44C 3/004; A44C 7/00; A44C  
7/002; A44C 7/003; A44C 7/004; A44C  
7/005; A44C 7/006; A44C 7/007; A44C  
7/008; A44C 7/009; A44C 13/00; A44C  
15/001; A44C 15/0005; A44C 15/0025;  
A44C 15/0045; A44C 25/001; A44C  
25/004; A44C 25/005; A44C 25/007;  
A44C 25/008; A44C 25/00; A44C 25/002  
See application file for complete search history.

(56) **References Cited**

**U.S. PATENT DOCUMENTS**

245,594 A \* 8/1881 Whitney ..... A44C 5/107  
59/82  
1,920,875 A \* 8/1933 Miskend ..... A44C 9/00  
63/15  
D152,363 S \* 1/1949 Philippe ..... D11/13  
D154,046 S \* 6/1949 Katz ..... D11/9  
D158,004 S \* 4/1950 Philippe ..... D11/15  
D166,621 S \* 4/1952 Philippe ..... D11/16

D170,384 S \* 9/1953 Philippe ..... D11/16  
D178,061 S \* 6/1956 Katz ..... D11/16  
D237,732 S \* 11/1975 Roberts ..... D11/79  
D394,412 S \* 5/1998 Hanson ..... D11/40  
D825,378 S \* 8/2018 Ellingson ..... D11/200

**OTHER PUBLICATIONS**

Kohl's PearLustre by Imperial Sterling Silver Freshwater Cultured Pearl Pendant, Dec. 9, 2014, [online], [site visited online Aug. 2, 2019]. Retrieved from url:https://www.kohls.com/product/prd-1250355/pearlustre-by-imperial-sterling-silver-freshwater-cultured-pearl-pendant.jsp?prdPV=1 (Year: 2014).\*  
Aurora Pendant, no date available, [online], [site visited Aug. 2, 2019]. Retrieved url:https://www.tasaki-global.com/jewellery/atelier/surrealism/aurora/P-16827-18KYG/?jewellery=pendant (Year: 2019).\*

\* cited by examiner

*Primary Examiner* — Jeffrey D Asch

*Assistant Examiner* — Tracey J Bell

(74) *Attorney, Agent, or Firm* — Fitch, Even, Tabin & Flannery LLP

(57) **CLAIM**

I claim the ornamental design for a pendant, as shown and described.

**DESCRIPTION**

FIG. 1 is a front, top, and right side perspective view of a pendant showing my new design;  
FIG. 2 is a front elevational view thereof;  
FIG. 3 is a rear elevational view thereof;  
FIG. 4 is a top plan view thereof;  
FIG. 5 is a bottom plan view thereof; and,  
FIG. 6 is a right side elevational view thereof, the opposite left side being identical.

The dot-dash broken lines denote the boundary of the claim, and form no part of the claimed design. The evenly dashed broken lines depict portions of the pendant that form no part of the claimed design.

**1 Claim, 6 Drawing Sheets**

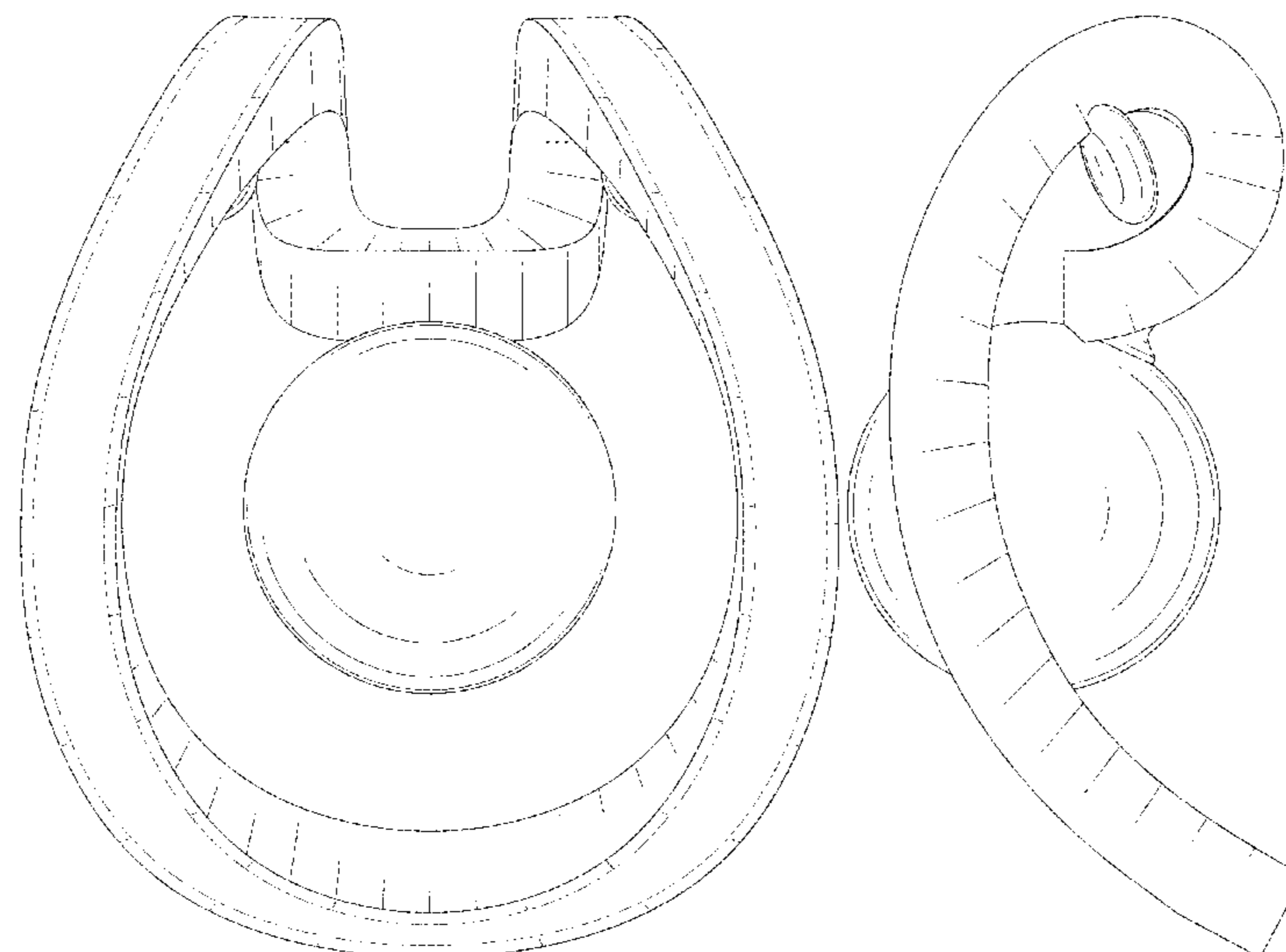

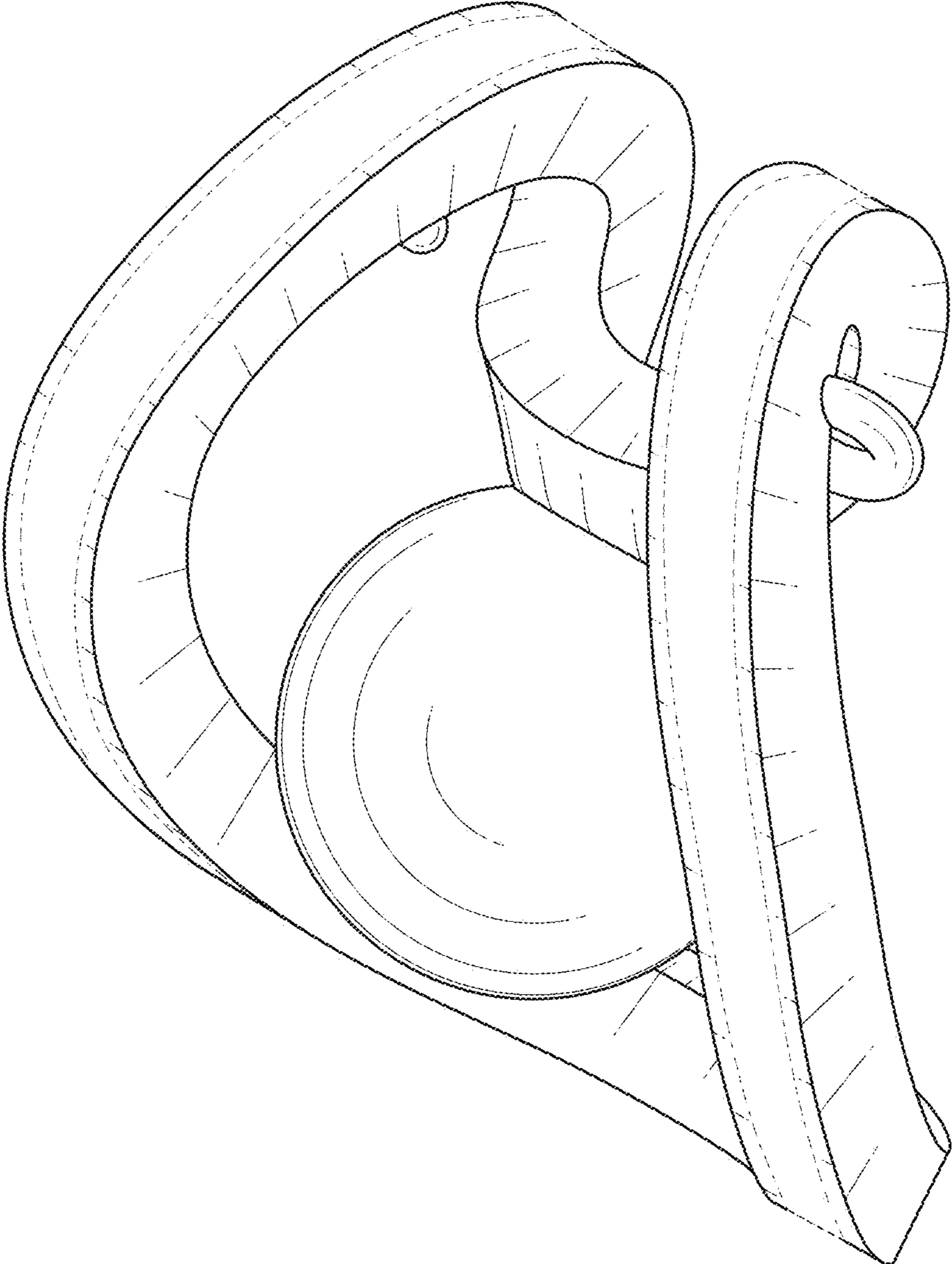

FIG. 1

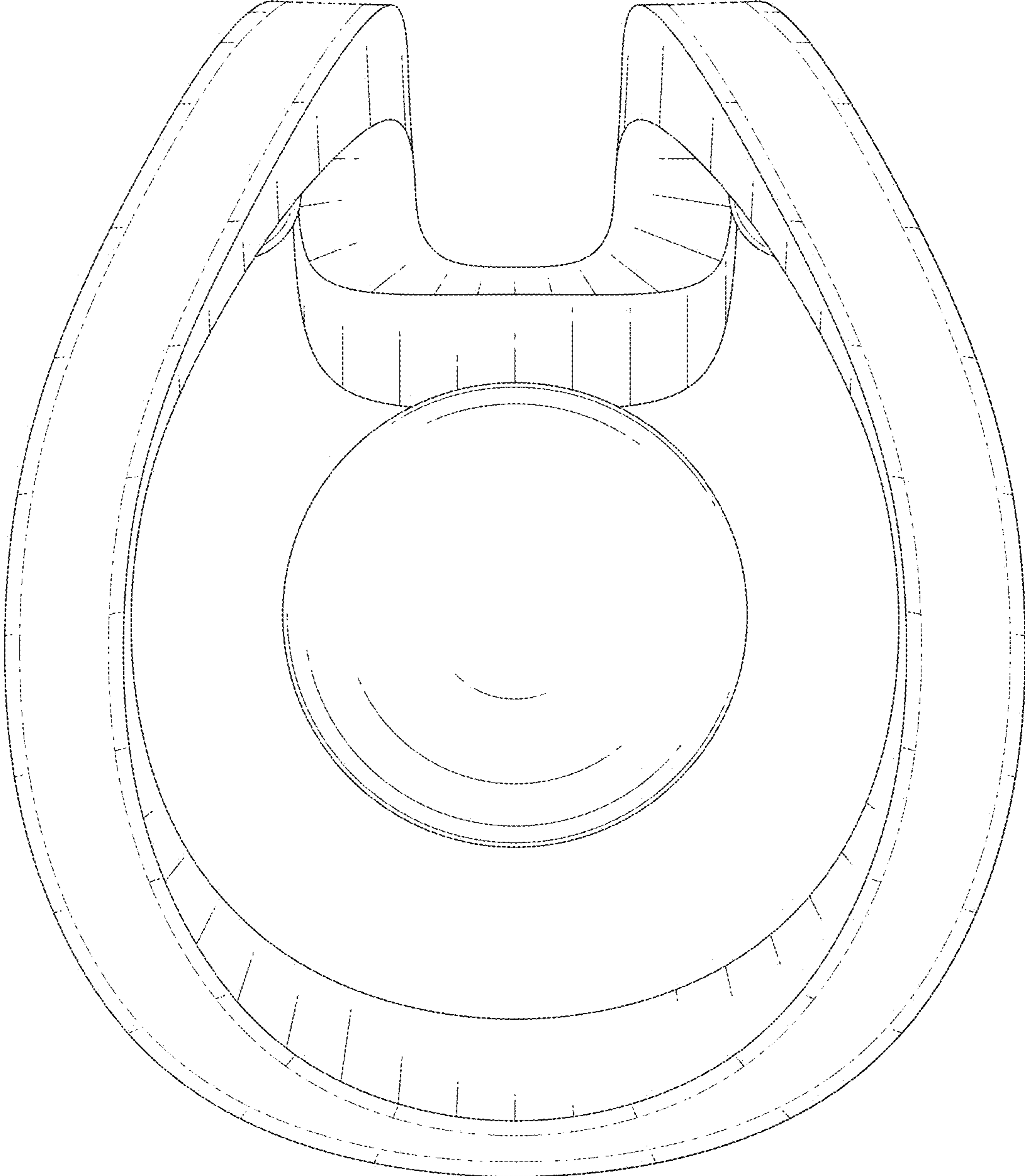

FIG. 2

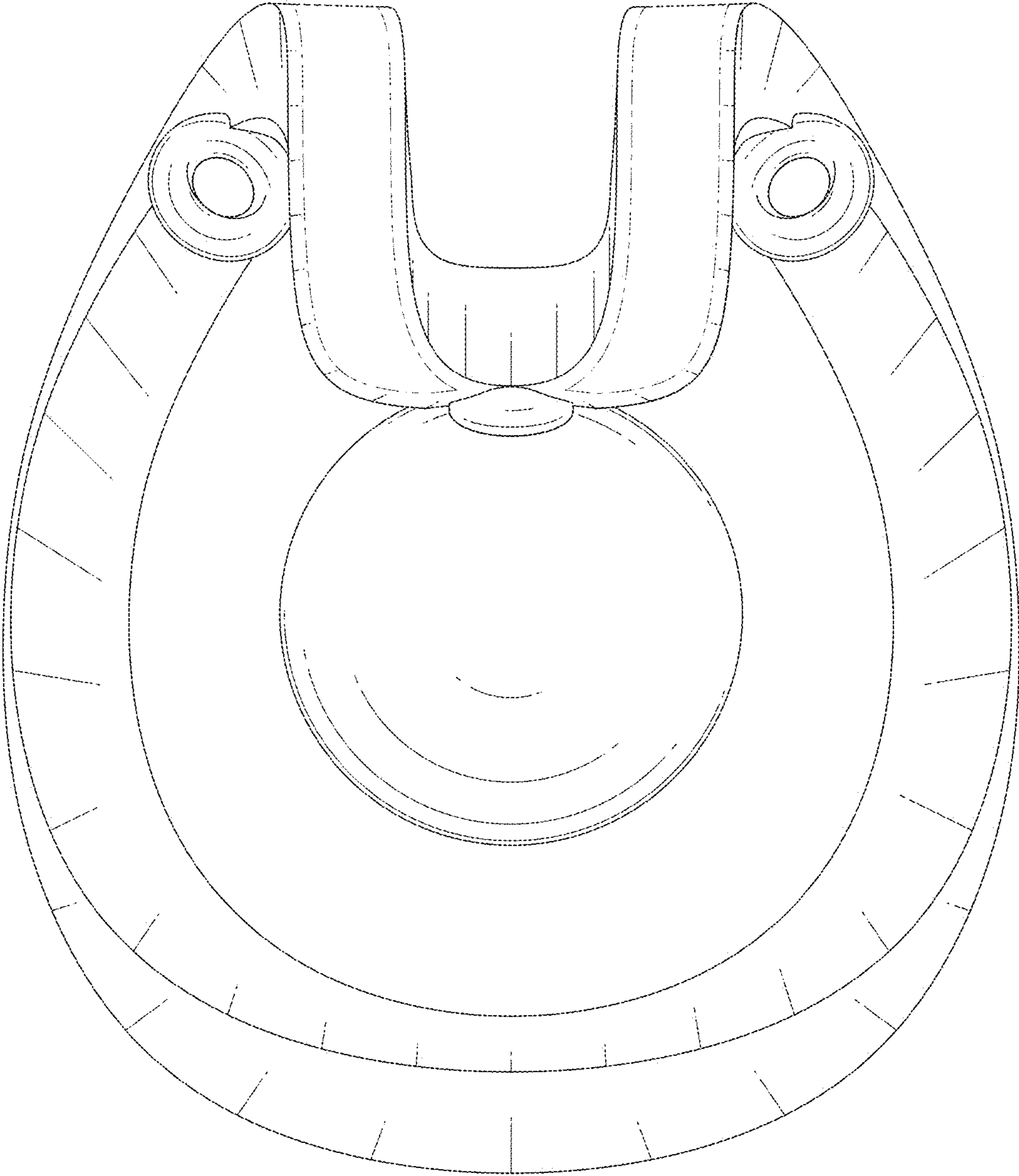

FIG. 3

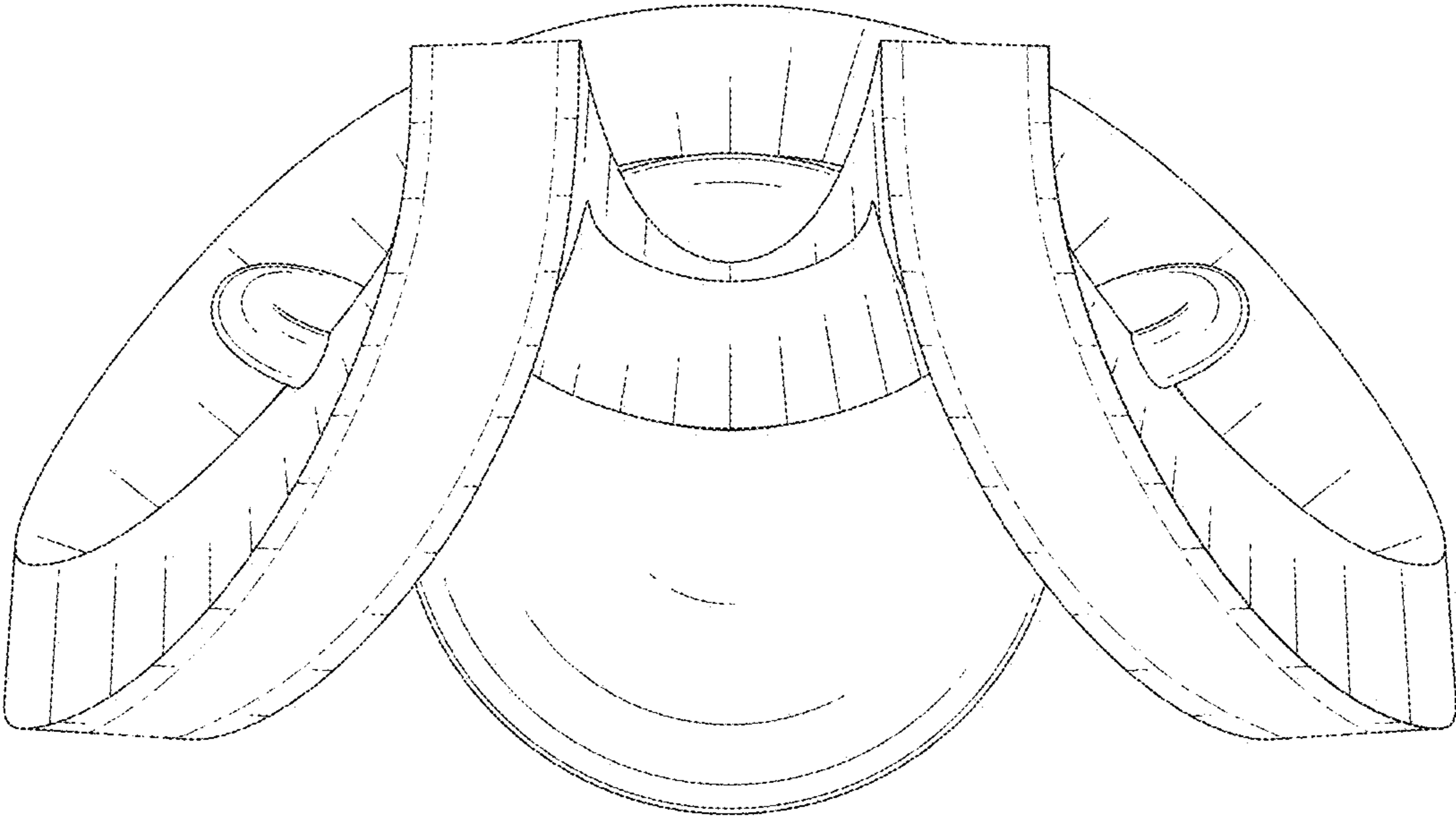

FIG. 4

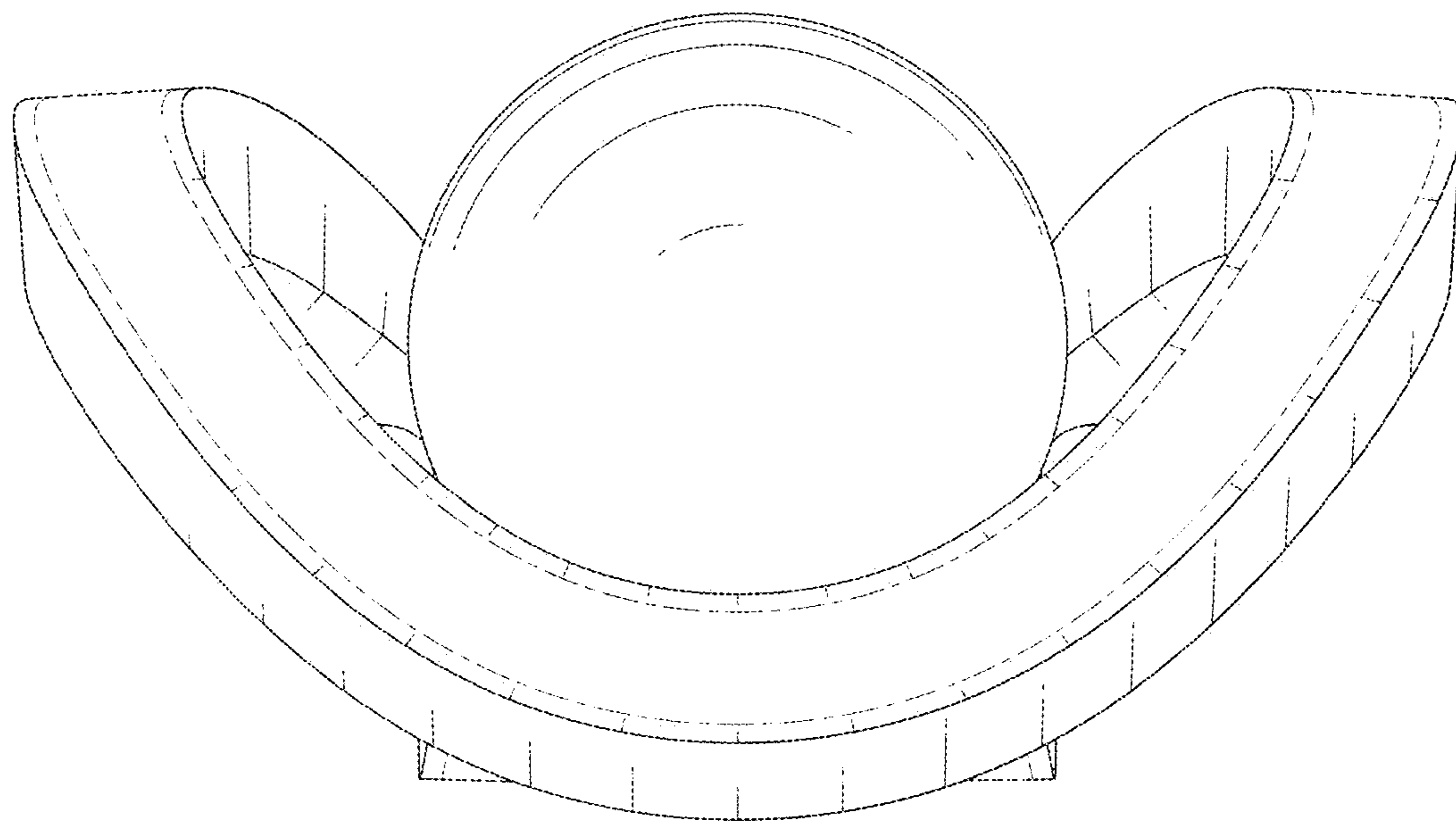

FIG. 5

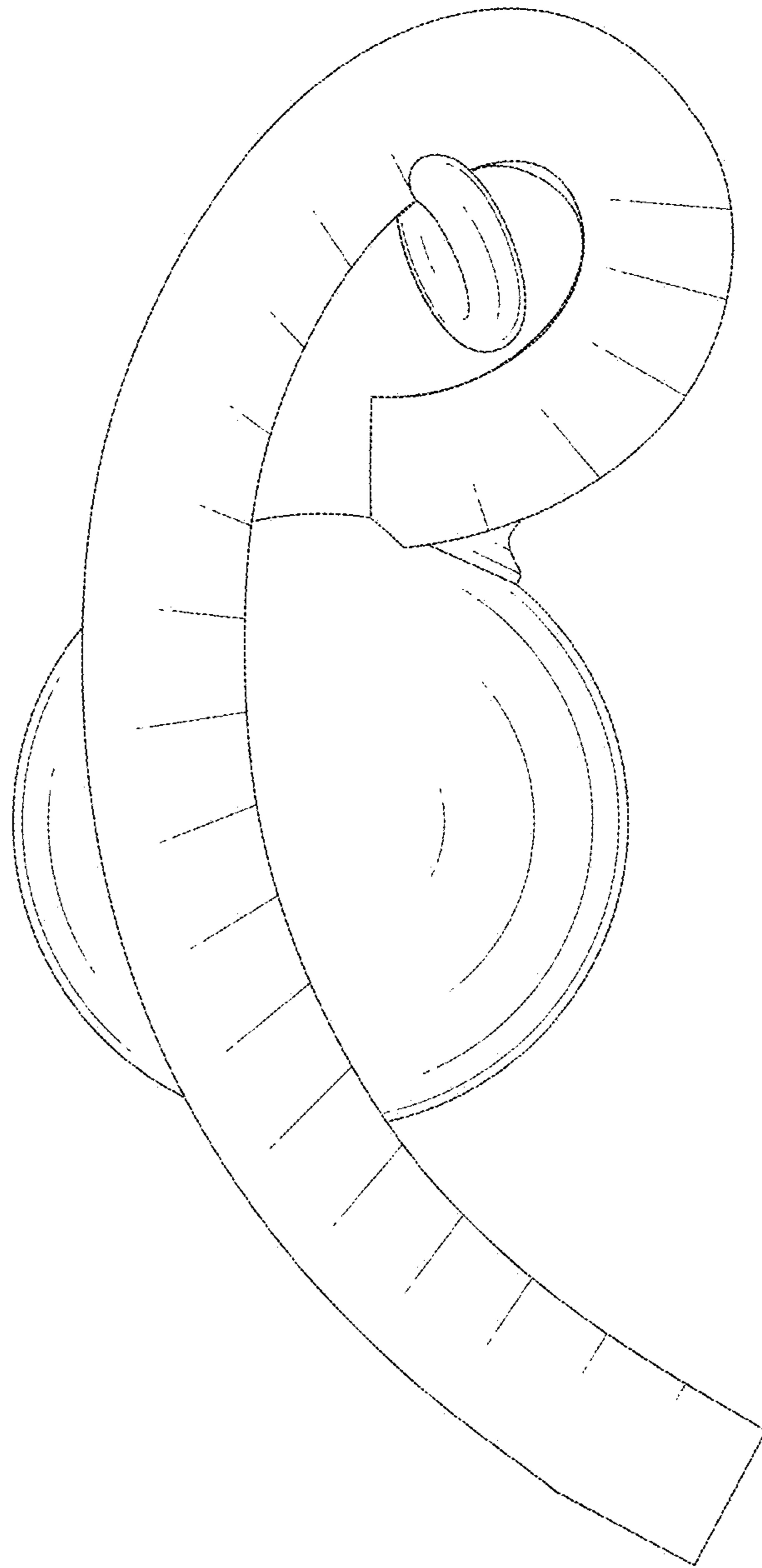

FIG. 6