



US00D882354S

(12) **United States Design Patent**
Salem et al.

(10) **Patent No.:** **US D882,354 S**
(45) **Date of Patent:** **** Apr. 28, 2020**

- (54) **FORK WITH O-GROOVED PRONGS**
- (71) Applicants: **Rafi M. Salem**, Alamo, CA (US); **Lois J. Salem**, Alamo, CA (US)
- (72) Inventors: **Rafi M. Salem**, Alamo, CA (US); **Lois J. Salem**, Alamo, CA (US)
- (**) Term: **15 Years**
- (21) Appl. No.: **29/720,764**
- (22) Filed: **Jan. 15, 2020**
- (51) **LOC (12) Cl.** **07-03**
- (52) **U.S. Cl.**
USPC **D7/653; D7/643**
- (58) **Field of Classification Search**
USPC D7/368, 401.2, 642-645, 653-664, 669, D7/675-677, 682-683, 688-689, 691; D8/107, 300-301; D22/117-118
CPC ... A01D 9/00; A01D 9/02; A01D 9/04; A01D 9/06; A47G 21/00; A47G 21/004; A47G 21/005; A47G 21/02; A47G 21/023; A47G 21/04; A47G 21/06; A47G 21/08; A47J 43/28; A47J 43/281; A47J 43/282; A47J 43/1093; A61F 13/10; A61J 7/0023; B25G 1/00; B25G 1/01; B25G 1/02; B25G 3/00; B65D 75/56; B65D 75/563; B65D 75/566; B67B 7/00; B67B 7/724; B67B 7/73
See application file for complete search history.

747,986 A *	12/1903	Layne	A01D 9/00
				294/55.5
858,970 A *	7/1907	French	A47J 43/1093
				416/70 R
1,294,031 A *	2/1919	Bigelow	A47G 21/08
				30/148
2,637,104 A *	5/1953	Samson	A47G 21/023
				30/322
4,326,743 A *	4/1982	Tamura	A01D 9/06
				172/378
D278,677 S *	5/1985	Zimetbaum	D7/682
D387,953 S *	12/1997	Town	D7/643
D527,230 S *	8/2006	Edelmann	D7/643
D766,671 S *	9/2016	Edelmann	D7/643
D793,173 S *	8/2017	Perez	A01D 9/06
				D7/643

* cited by examiner

Primary Examiner — Ricky Pham

(57) **CLAIM**

The ornamental design for a fork with O-grooved prongs, as shown and described.

DESCRIPTION

FIG. 1 is a perspective view of the fork with O-grooved prongs showing my new design.
 FIG. 2 is a bottom view of the instant invention.
 FIG. 3 is top view of the instant invention.
 FIG. 4 is back view of the instant invention
 FIG. 5 is front view of the instant invention
 FIG. 6 is a right side view of the instant invention.
 FIG. 7 is a left side view of the instant invention; and,
 FIG. 8 is cross sectional view taken through line 8-8 of FIG. 2.

1 Claim, 4 Drawing Sheets

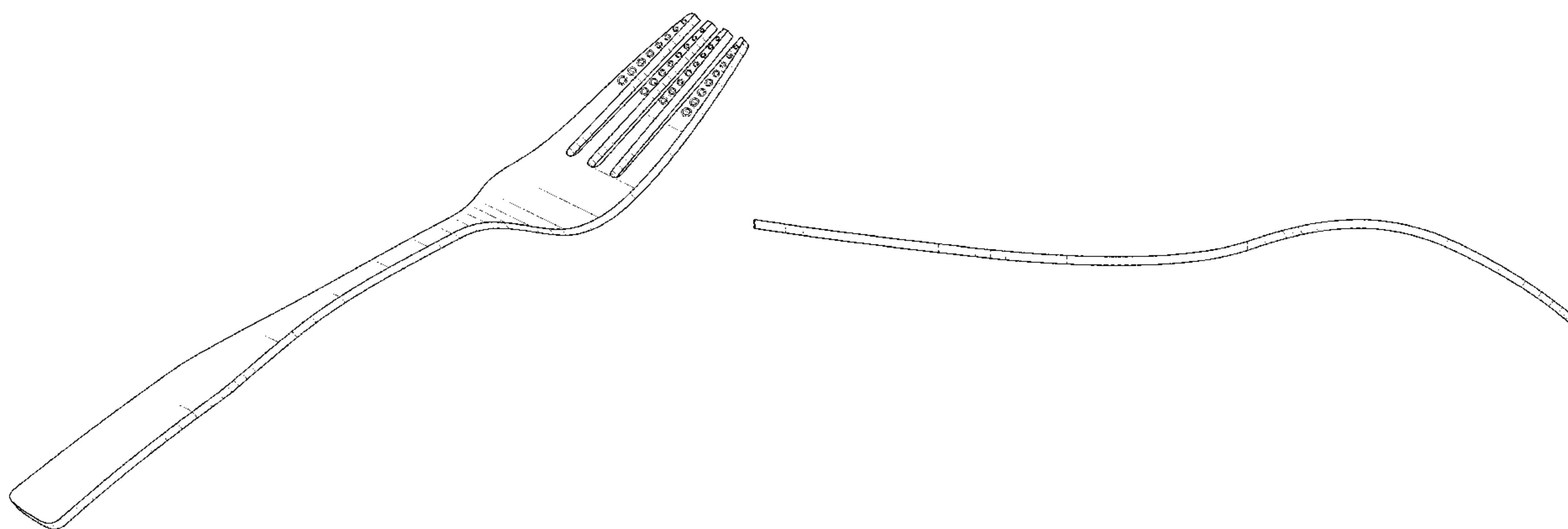

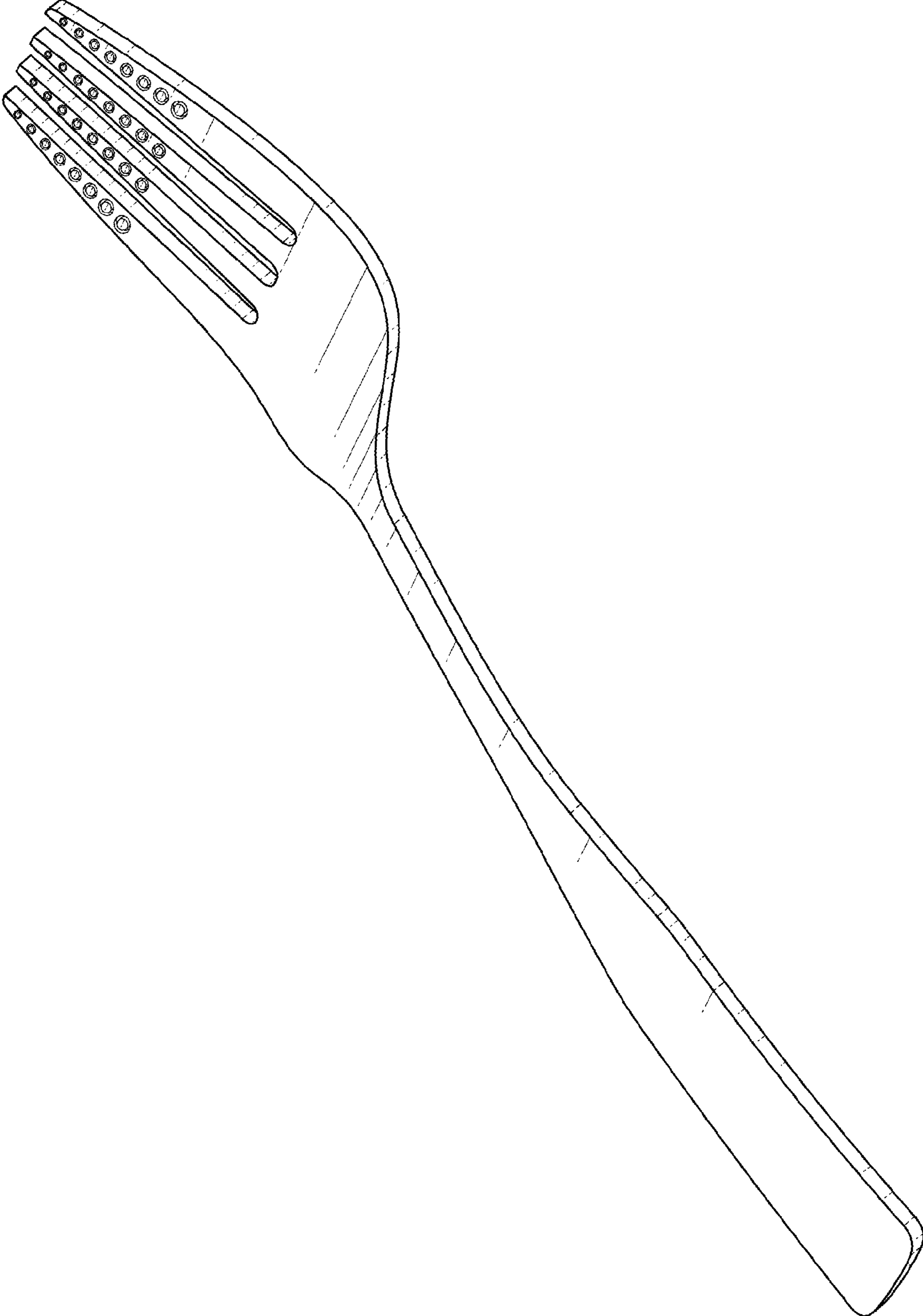

FIG. 1

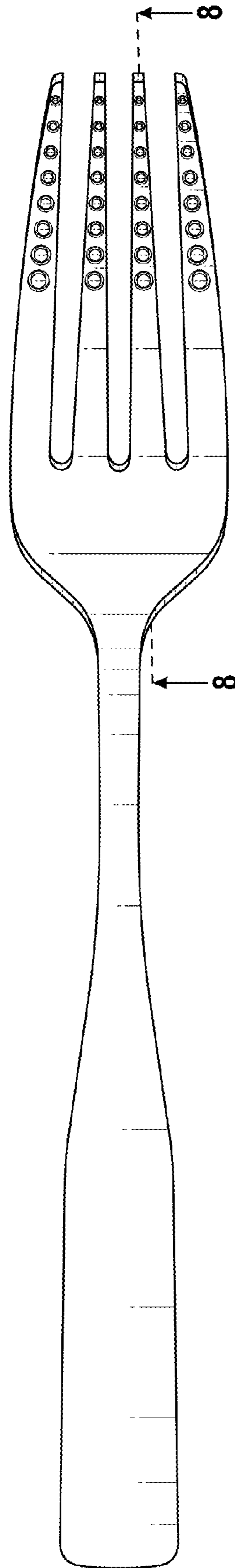

FIG. 2

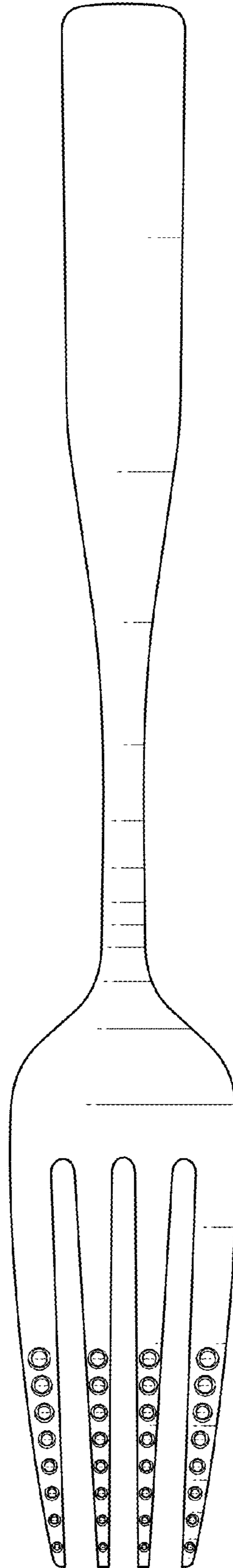

FIG. 3

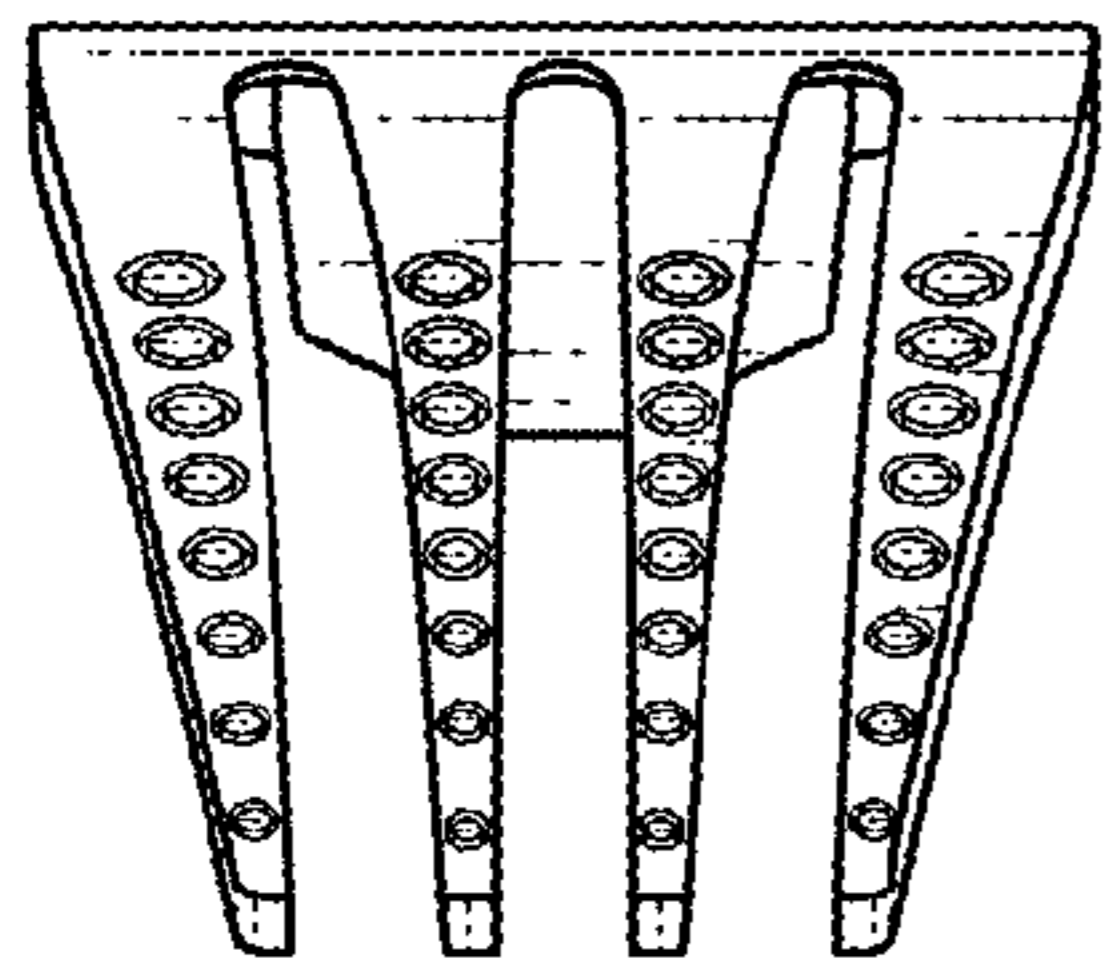

FIG. 5

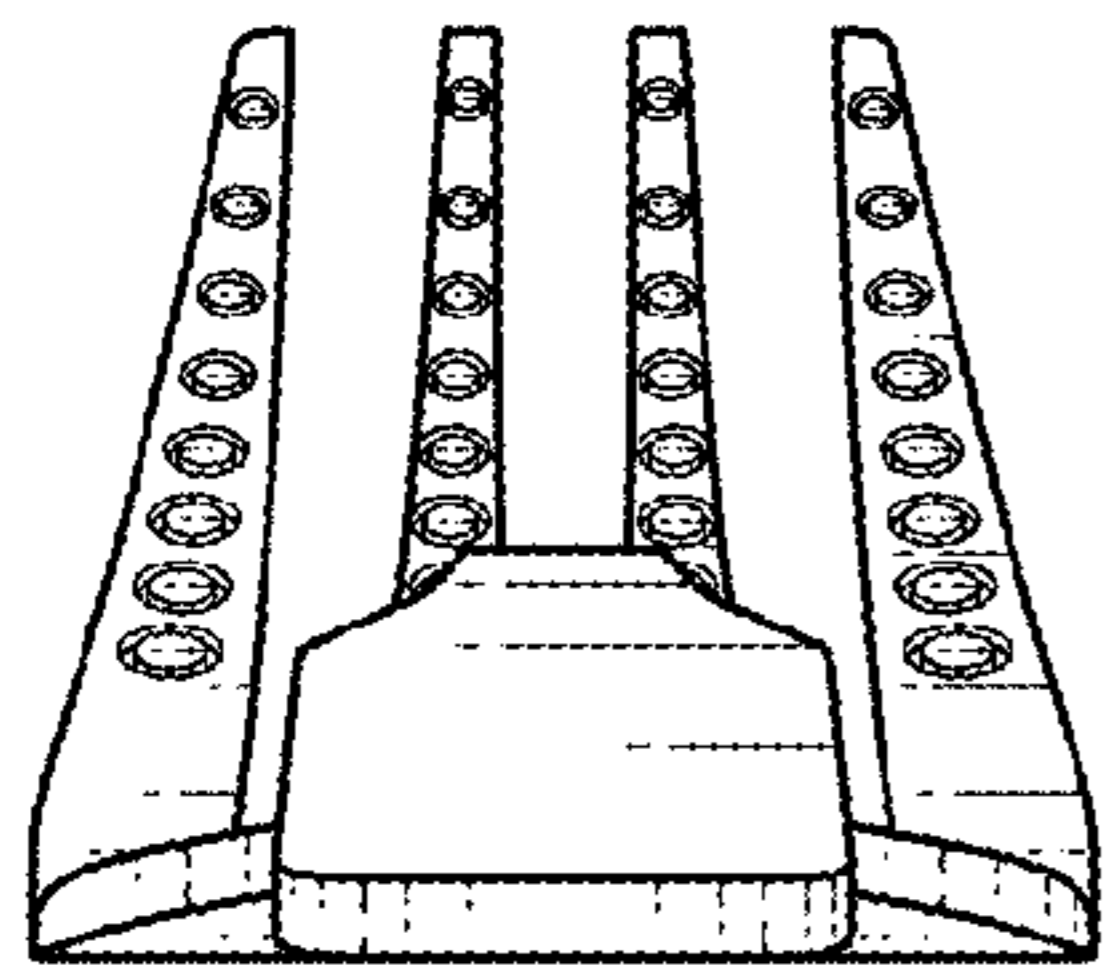

FIG. 4

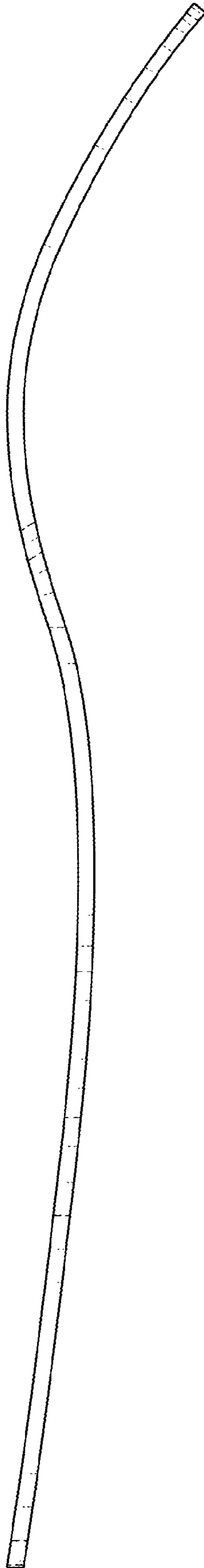

FIG. 6

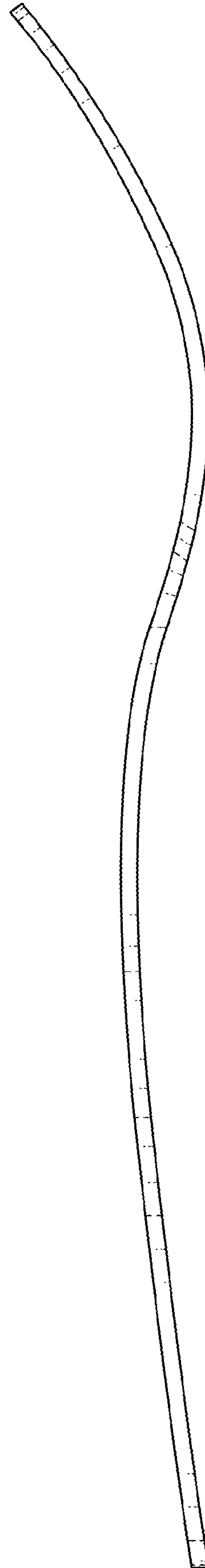

FIG. 7

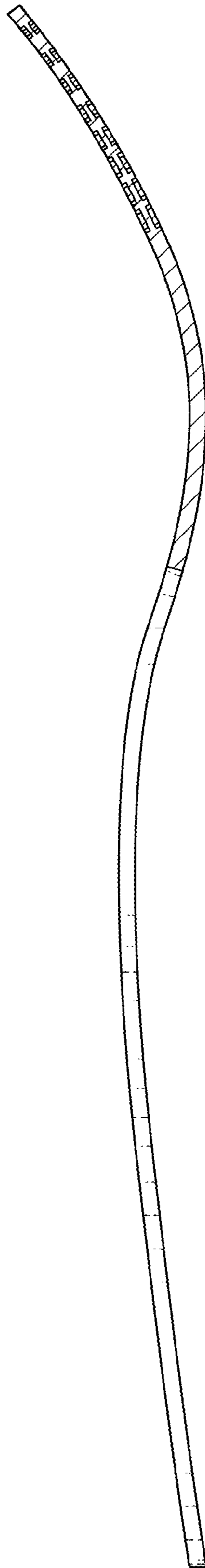

FIG. 8