



US00D882348S

(12) **United States Design Patent**
Lee

(10) **Patent No.:** **US D882,348 S**
(45) **Date of Patent:** **** Apr. 28, 2020**

- (54) **EATING UTENSIL**
- (71) Applicant: **Keun Jig Lee**, Paju-si (KR)
- (72) Inventor: **Keun Jig Lee**, Paju-si (KR)
- (**) Term: **15 Years**
- (21) Appl. No.: **29/672,855**
- (22) Filed: **Dec. 10, 2018**
- (51) **LOC (12) Cl.** **07-03**
- (52) **U.S. Cl.**
USPC **D7/643**; D7/642; D7/653
- (58) **Field of Classification Search**
USPC D7/368, 401.2, 642-645, 653-664, 669,
D7/675-677, 683, 686, 688-689, 691;
D8/107, 300-301; D22/117-118
CPC ... A01D 9/02; A01D 9/04; A01D 9/06; A47G
21/00; A47G 21/004; A47G 21/005;
A47G 21/02; A47G 21/023; A47G 21/04;
A47G 21/06; A47G 21/08; A47J 43/28;
A47J 43/281; A47J 43/282; A61F 13/10;
A61J 7/0023; B25G 1/00; B25G 1/01;
B25G 1/02; B25G 3/00; B65D 75/56;
B65D 75/563; B65D 75/566; B67B 7/00;
B67B 7/724; B67B 7/73
See application file for complete search history.

- 4,809,435 A * 3/1989 Printz A47G 21/02
294/3
- 5,373,640 A * 12/1994 Cordeiro, Jr. A47G 21/023
294/99.2
- D601,389 S * 10/2009 Brown D7/642
- 7,878,563 B2 * 2/2011 Beckham A47G 21/103
294/218
- D844,390 S * 4/2019 Reed D7/643
- D852,004 S * 6/2019 Yip D7/643
- D862,995 S * 10/2019 Androxman D7/643
- 2014/0059783 A1 * 3/2014 Lu A47G 21/02
7/158

* cited by examiner

Primary Examiner — Ricky Pham

(57) **CLAIM**

The ornamental design for an eating utensil, as shown and described.

DESCRIPTION

FIG. 1 is a perspective view of an eating utensil showing my new design;
 FIG. 2 is a front elevational thereof;
 FIG. 3 is a rear elevational view thereof;
 FIG. 4 is a left side elevational view thereof;
 FIG. 5 is a right side elevational view thereof;
 FIG. 6 is a top plan view thereof; and,
 FIG. 7 is a bottom plan view thereof.
 The dotted line portions in each of the drawing figures are by way of illustration only and form no part of the claimed design.

1 Claim, 7 Drawing Sheets

(56) **References Cited**

U.S. PATENT DOCUMENTS

- 1,490,785 A * 4/1924 Purnell A47G 21/181
30/141
- D193,440 S * 8/1962 Vernon D7/686

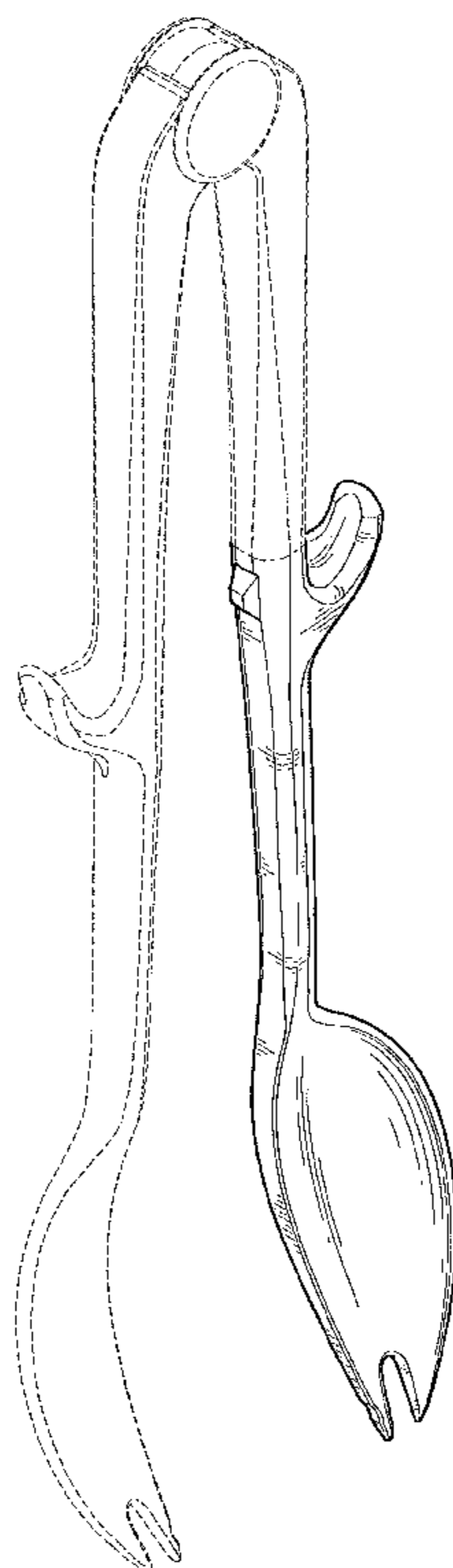

FIG. 1

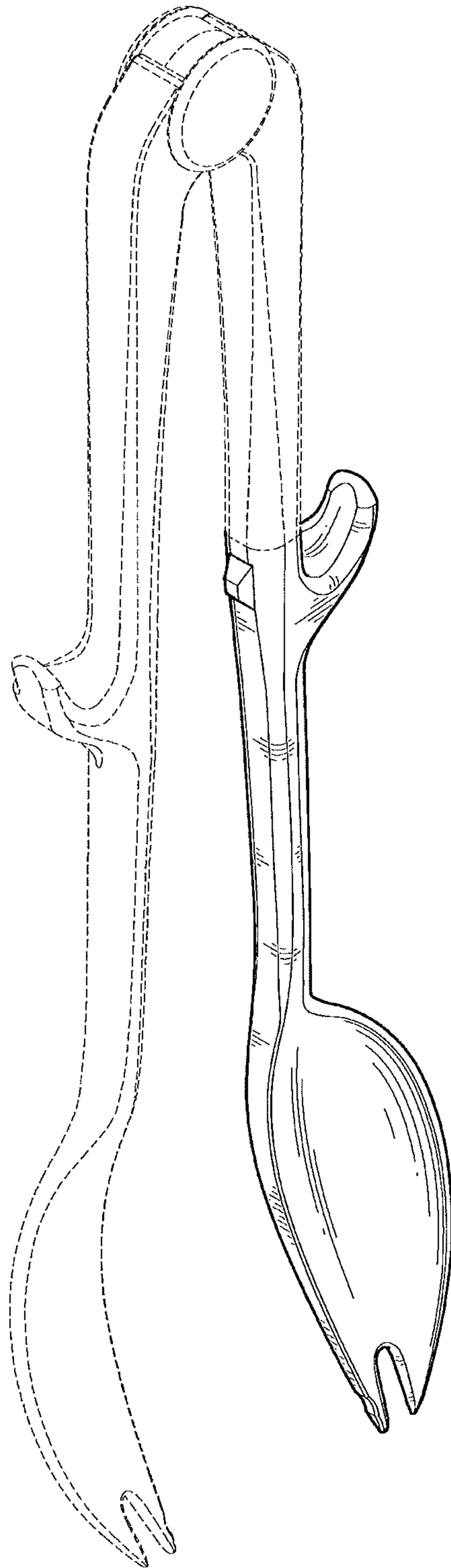

FIG. 2

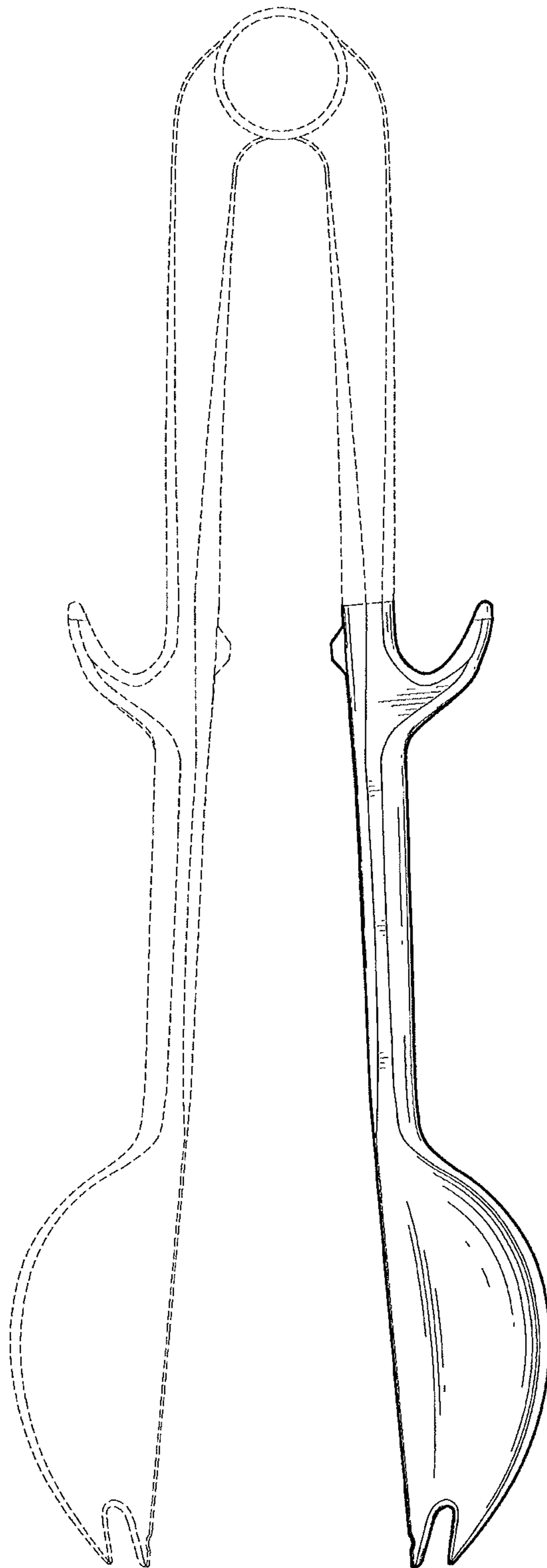

FIG. 3

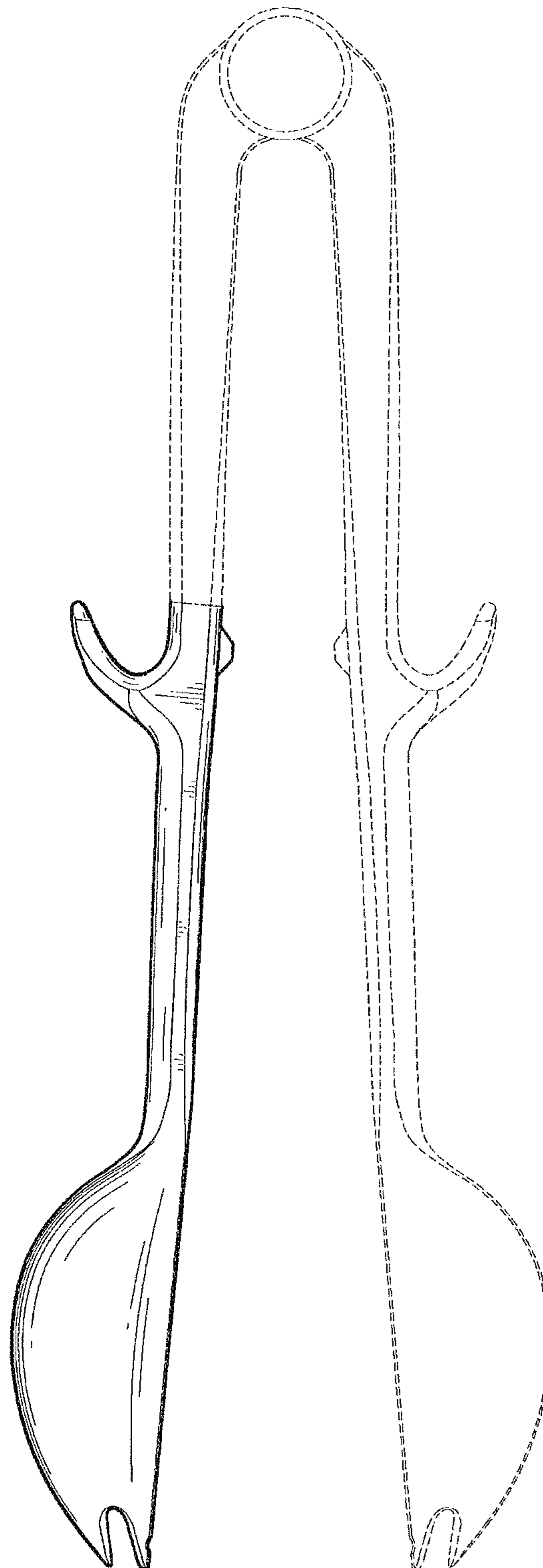

FIG. 4

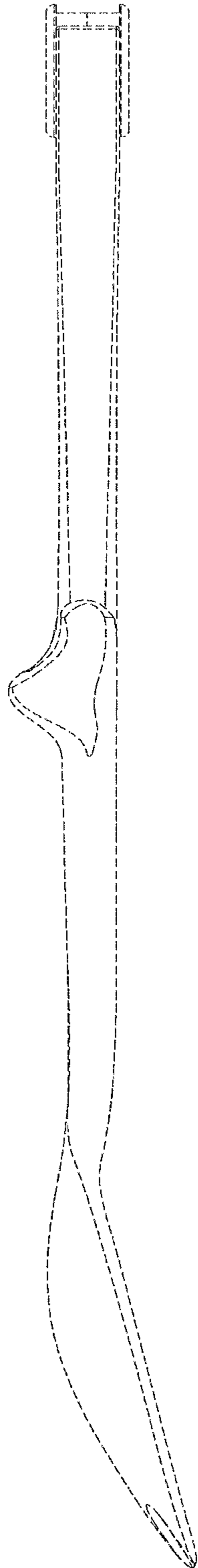

FIG. 5

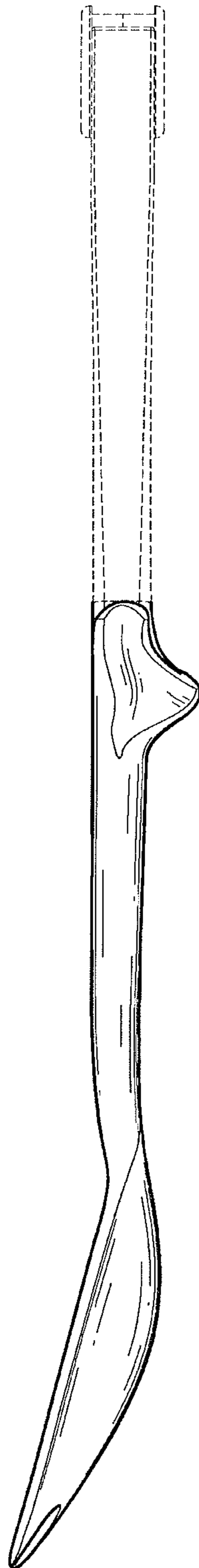

FIG. 6

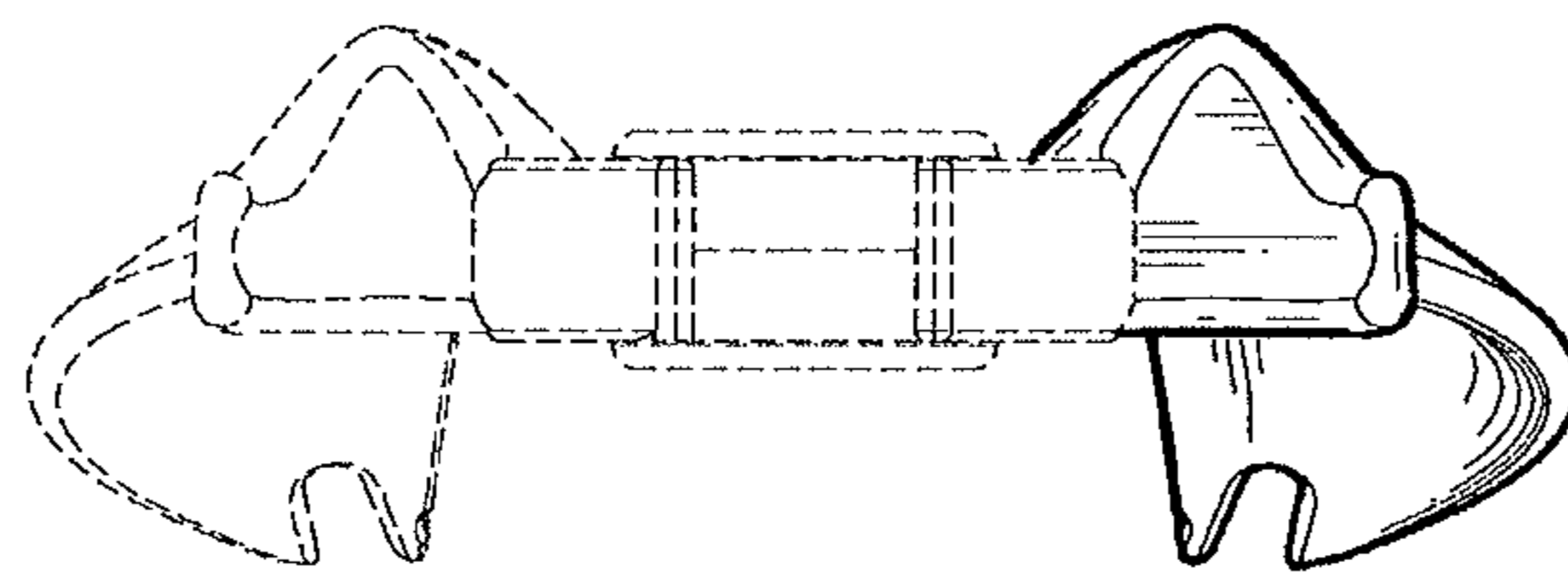

FIG. 7

