



US00D882286S

(12) **United States Design Patent**  
**Zoretic**

(10) **Patent No.:** **US D882,286 S**  
(45) **Date of Patent:** **\*\* Apr. 28, 2020**

(54) **HOCKEY STICK RACK**

(71) Applicant: **Krusader LLC**, Ladera Ranch, CA  
(US)

(72) Inventor: **Marko R. Zoretic**, Coto de Caza, CA  
(US)

(73) Assignee: **Krusader LLC**, Rancho Santa  
Margarita, CA (US)

(\*\*) Term: **15 Years**

(21) Appl. No.: **29/669,657**

(22) Filed: **Nov. 9, 2018**

(51) **LOC (12) Cl.** ..... **08-08**

(52) **U.S. Cl.**  
USPC ..... **D6/552**

(58) **Field of Classification Search**  
USPC ..... D6/552, 329, 512-514, 553, 569, 570,  
D6/571; D34/4-6; 211/13.1, 85.7, 62,  
211/68, 70.2, 70.5, 70.6, 70.8, 65, 70.1  
CPC ..... A63B 2102/22; A63B 2102/24; A47B  
81/005

See application file for complete search history.

(56) **References Cited**

U.S. PATENT DOCUMENTS

6,547,085	B2	4/2003	Belisle	
D538,570	S *	3/2007	Tate	D6/552
7,441,669	B1	10/2008	Dalbey	
D604,977	S *	12/2009	Conville	D6/552
D677,504	S *	3/2013	Childs	D6/552
D736,010	S	8/2015	Reed, Jr.	
D786,581	S *	5/2017	Lien	D6/552

(Continued)

OTHER PUBLICATIONS

Becker Arena Products, Inc.; Hockey Stick Rack <https://beckerarena.com/catalog/product/gallery/id/1166/image/3142/>, accessed Dec. 19, 2018 (1 page).

(Continued)

*Primary Examiner* — Wan Laymon

*Assistant Examiner* — Mark Booker

(74) *Attorney, Agent, or Firm* — Perkins Coie LLP

(57) **CLAIM**

The ornamental design for a hockey stick rack, as shown and described.

**DESCRIPTION**

FIG. 1 is an isometric view of a hockey stick rack showing the new design.

FIG. 2 is a front view of the hockey stick rack in FIG. 1.

FIG. 3 is a back view of the hockey stick rack in FIG. 1.

FIG. 4 is a right side view of the hockey stick rack in FIG. 1.

FIG. 5 is a left side view of the hockey stick rack in FIG. 1.

FIG. 6 is an enlarged top view of the hockey stick rack in FIG. 1.

FIG. 7 is an enlarged bottom view of the hockey stick rack in FIG. 1.

FIG. 8 is an isometric view of a hockey stick rack showing the new design.

FIG. 9 is a front view of the hockey stick rack in FIG. 8.

FIG. 10 is a back view of the hockey stick rack in FIG. 8.

FIG. 11 is a right side view of the hockey stick rack in FIG. 8.

FIG. 12 is a left side view of the hockey stick rack in FIG. 8.

FIG. 13 is an enlarged top view of the hockey stick rack in FIG. 8; and,

FIG. 14 is an enlarged bottom view of the hockey stick rack in FIG. 8.

The details shown in broken lines illustrate portions of the hockey stick rack that form no part of the claimed design.

**1 Claim, 12 Drawing Sheets**

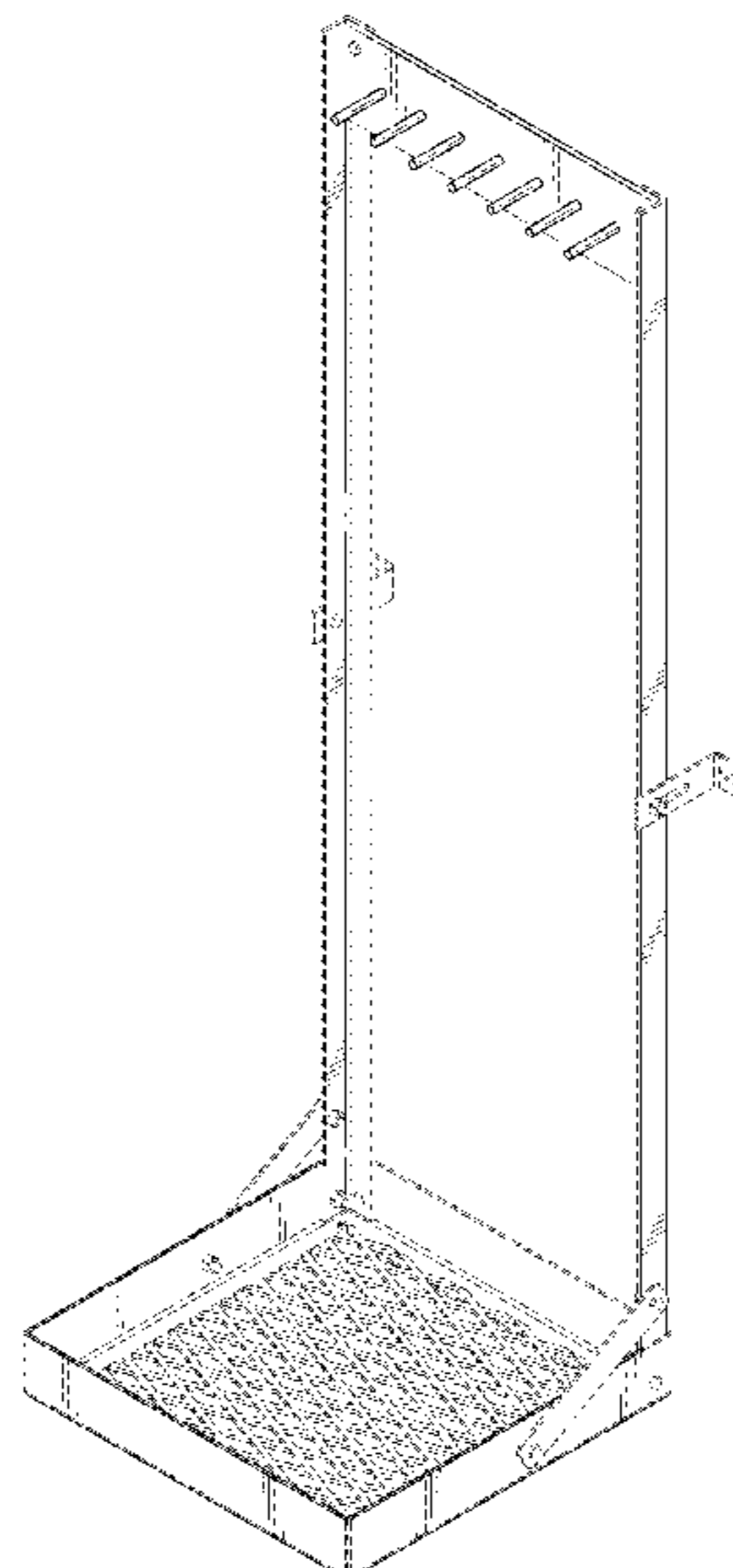

(56)

**References Cited**

U.S. PATENT DOCUMENTS

D801,726 S \* 11/2017 Atkins ..... D6/552  
2007/0084811 A1 4/2007 Dolson et al.  
2007/0163975 A1 7/2007 Holland

OTHER PUBLICATIONS

X Hockey Products; Hockey Stick Cart with Caster Wheels <https://www.xhockeyproducts.com/hockey-stick-cart-with-caster-wheels.html>, accessed Dec. 19, 2018 (4 pages).

Hockey Stick Builds; Stick Rack <http://hockeystickbuilds.com/stick-rack/>, accessed Dec. 19, 2018 (10 pages).

Rink Systems, Inc.; Accessories—Locker Rooms & Seating <http://www.rinksystems.com/products/accessories/locker-rooms-seating.html>, accessed Dec. 19, 2018 (11 pages).

\* cited by examiner

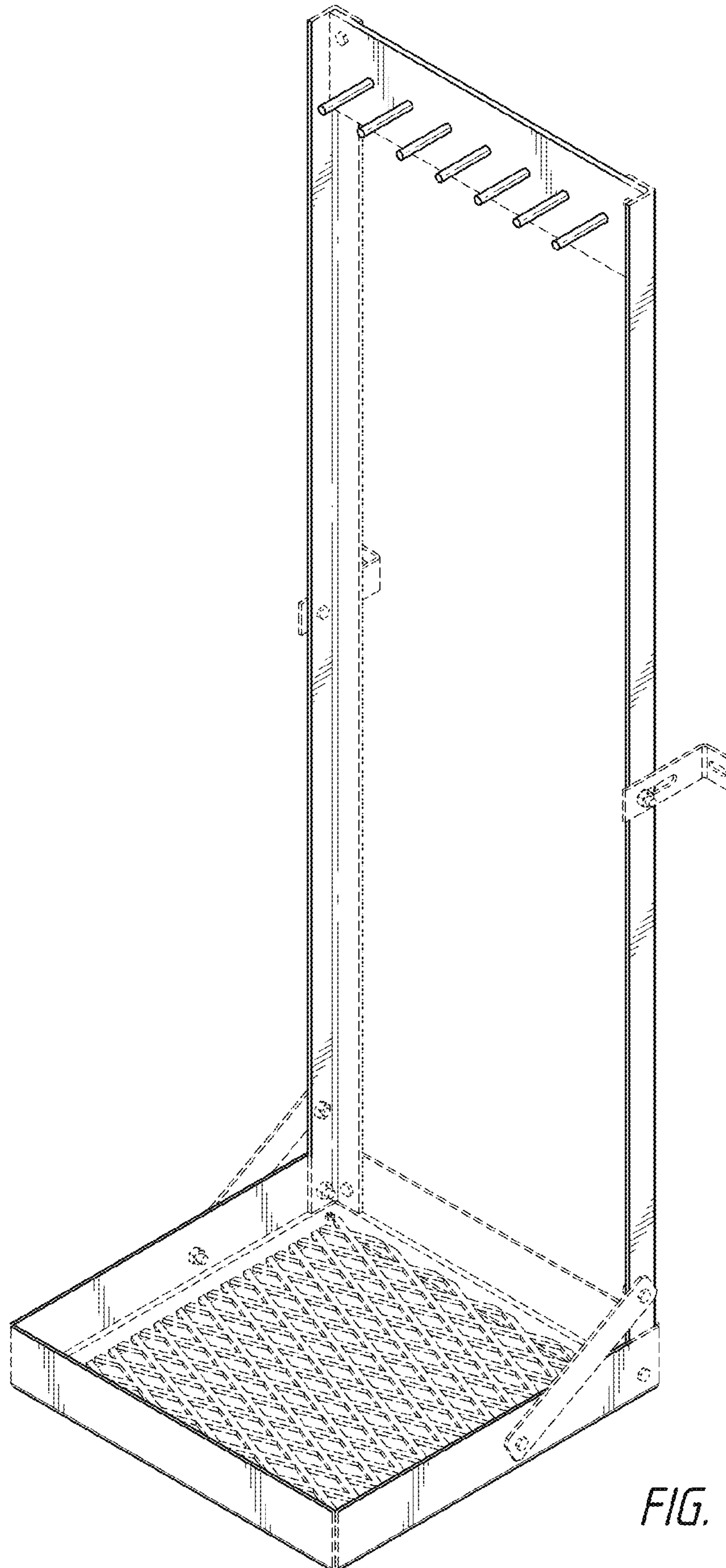

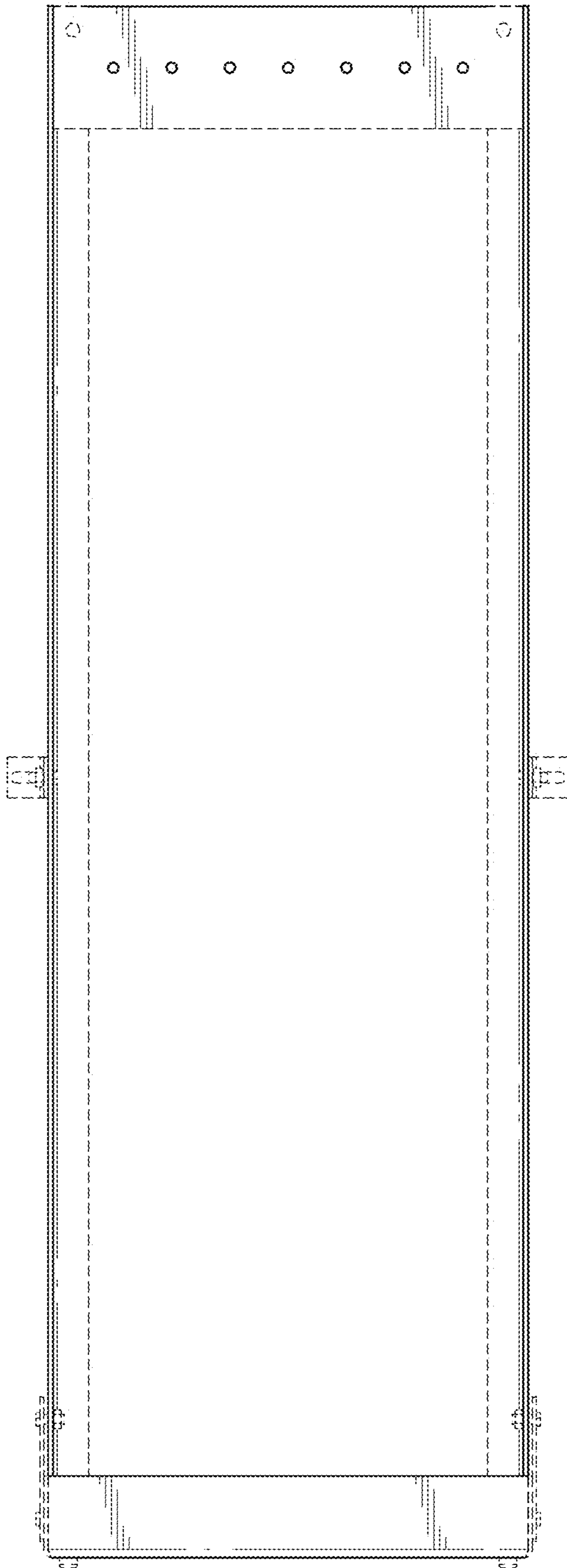

FIG. 2

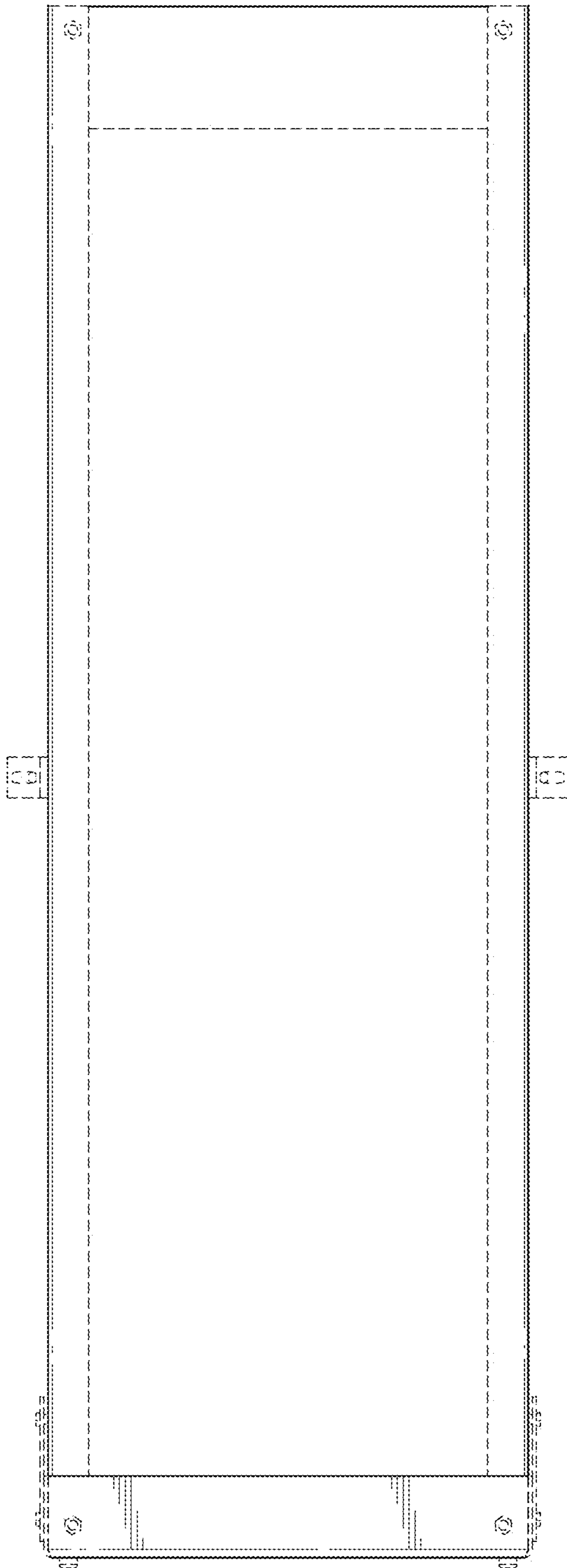

FIG. 3



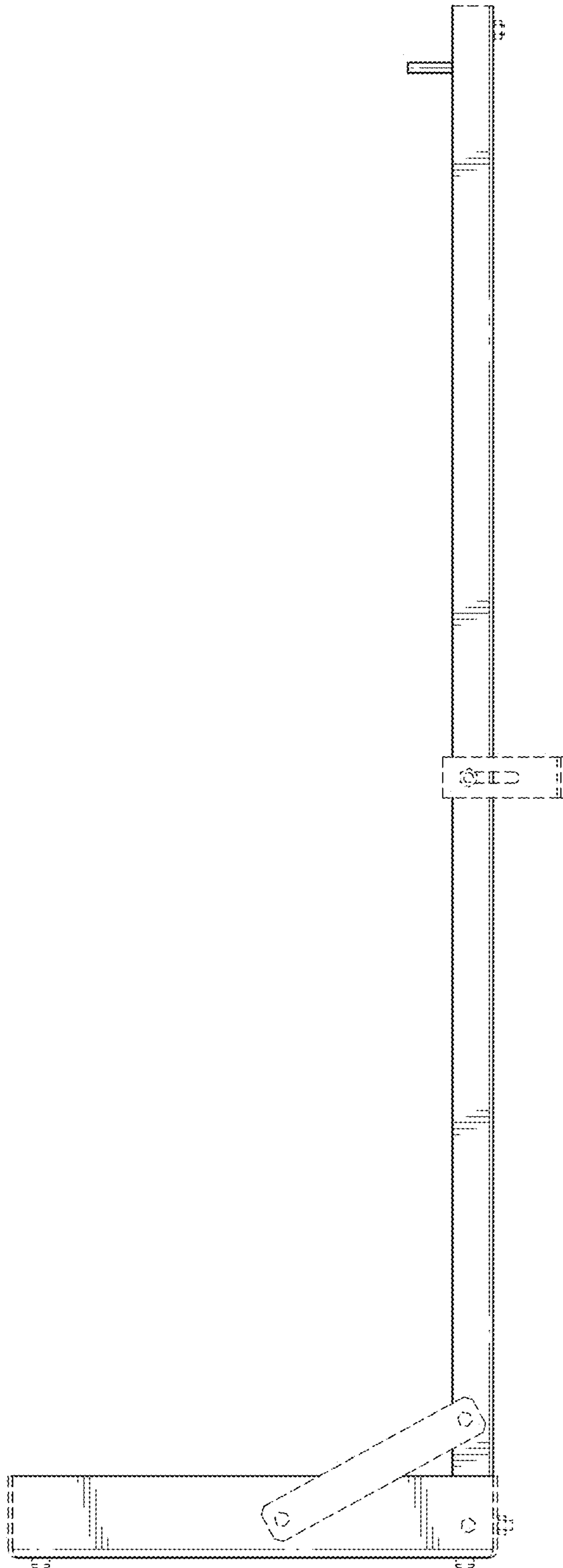

FIG. 4

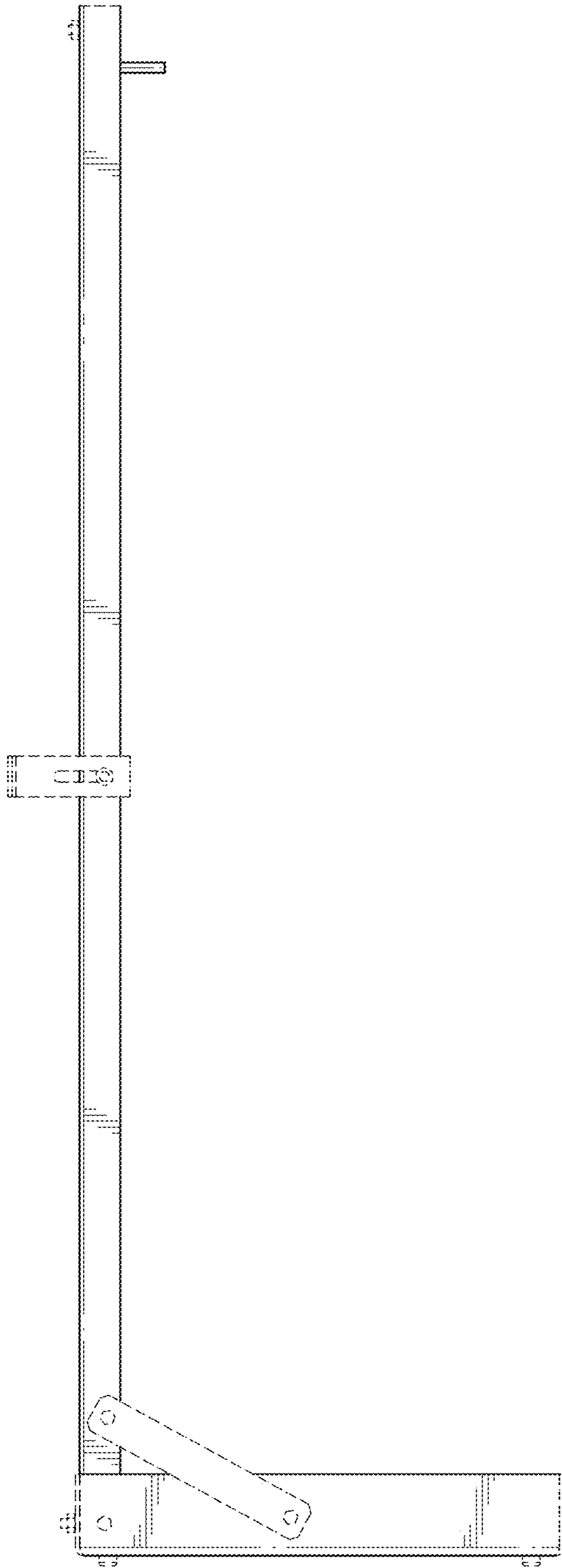

FIG. 5

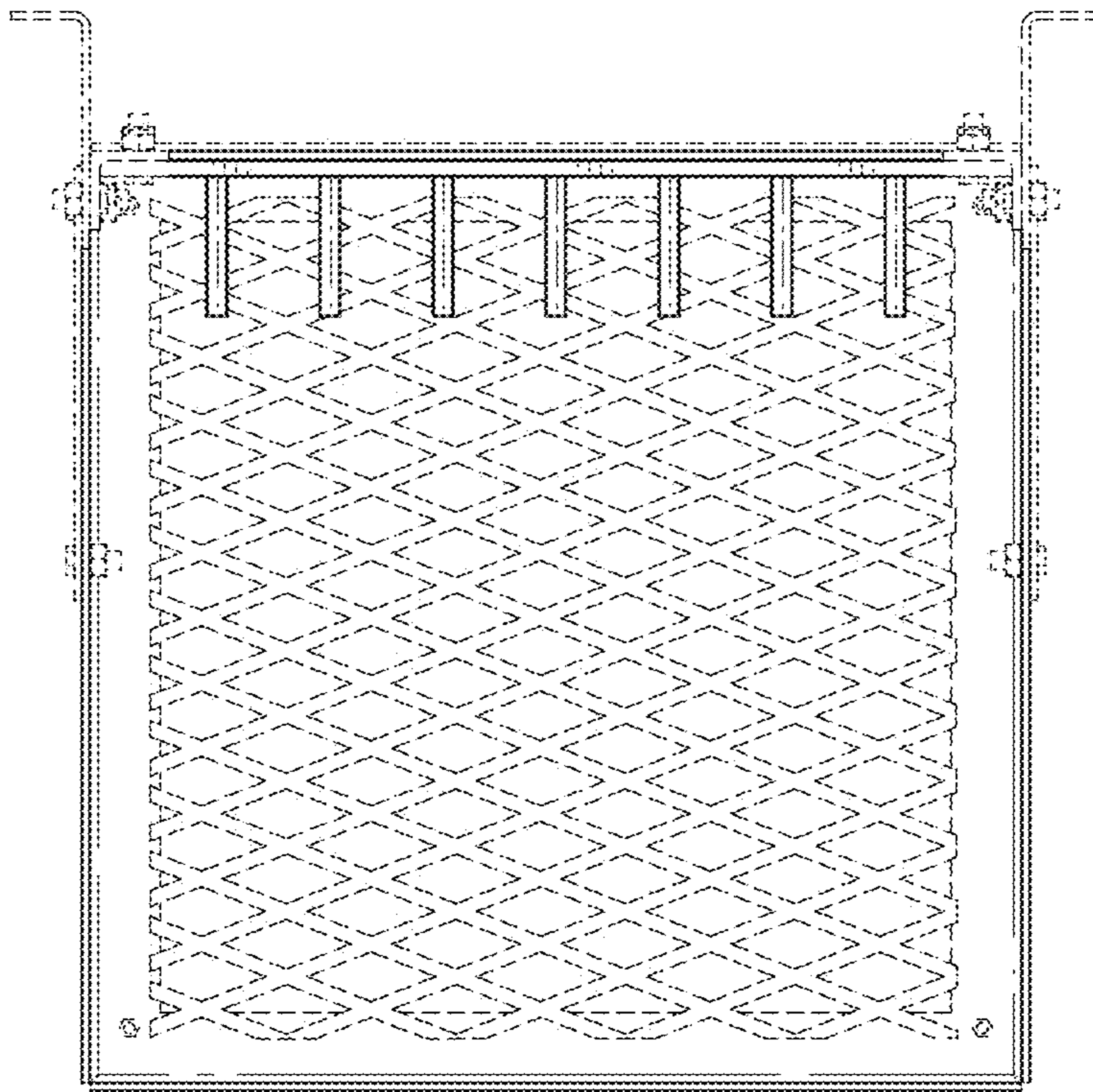

FIG. 6

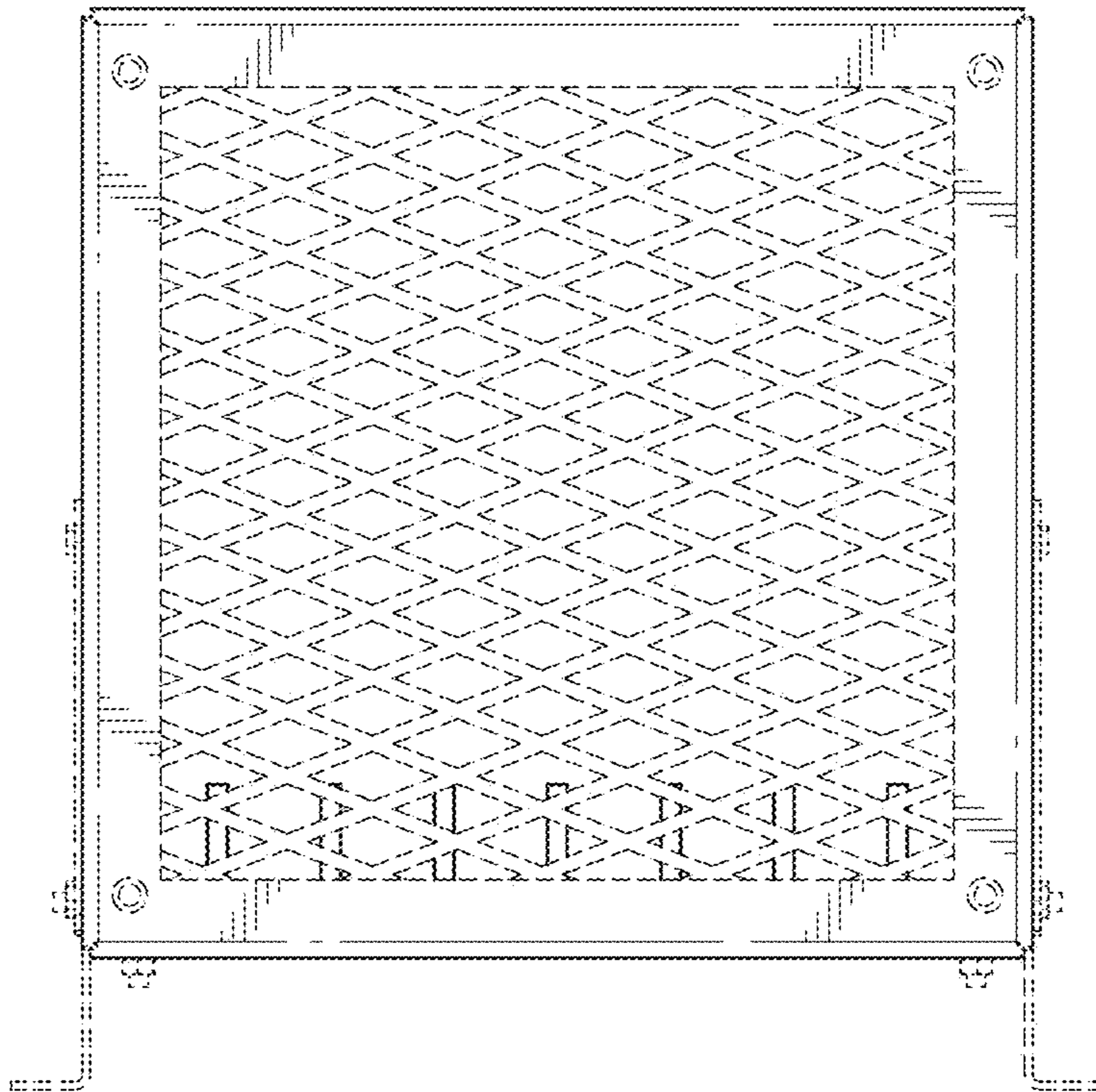

FIG. 7



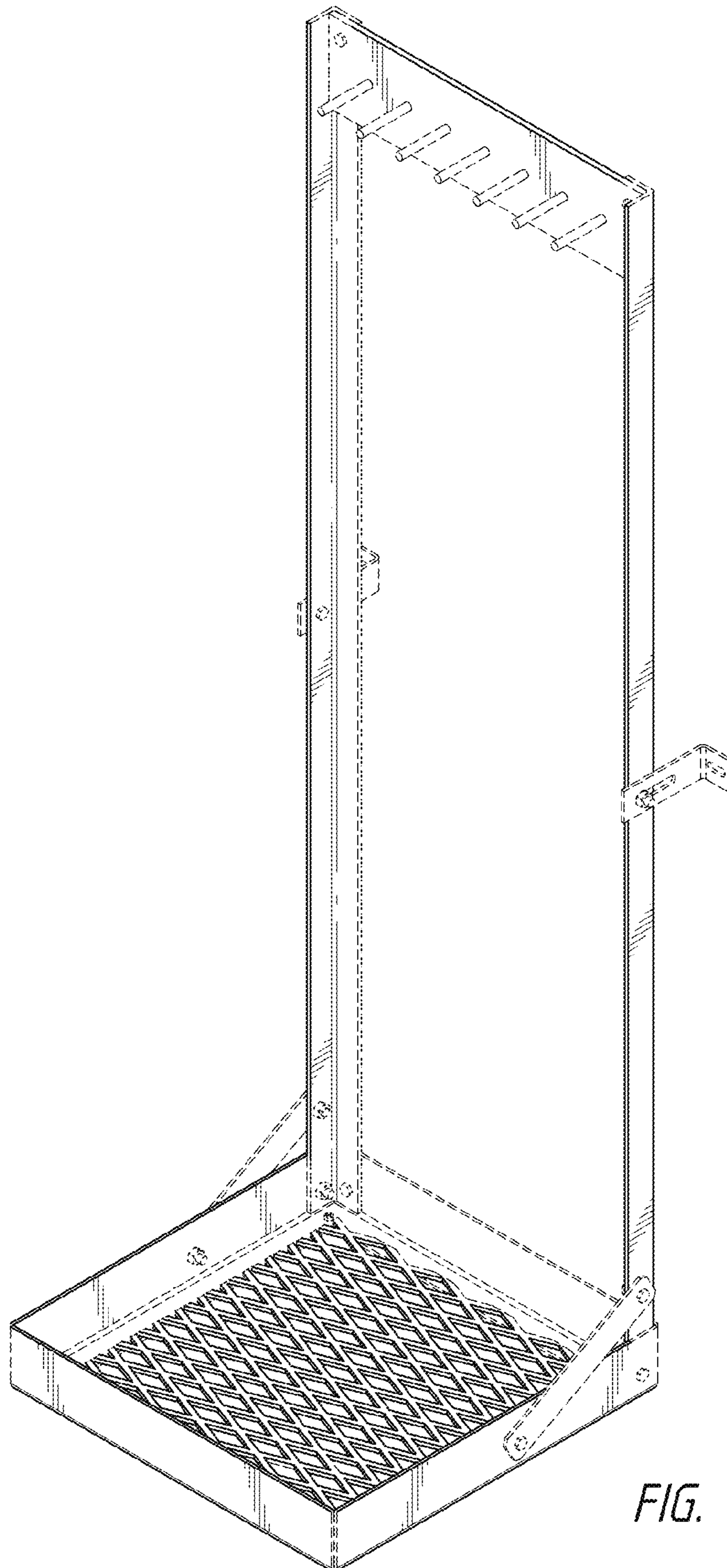

FIG. 8

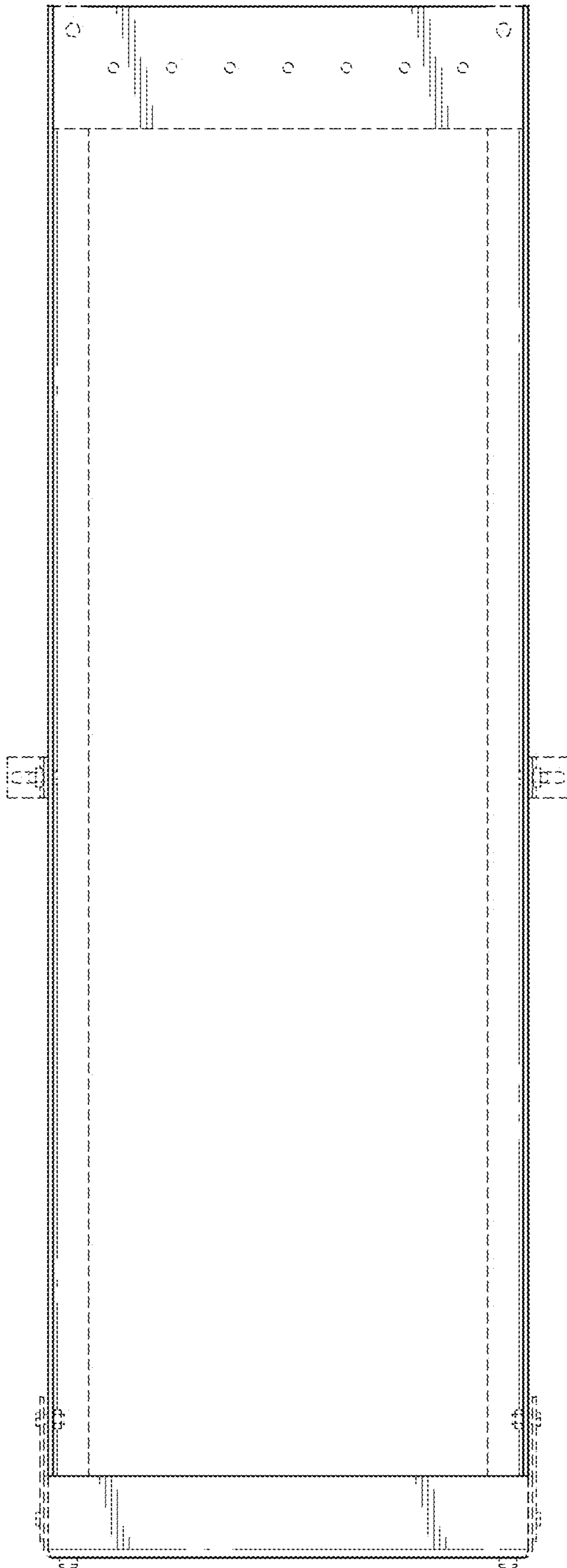

FIG. 9

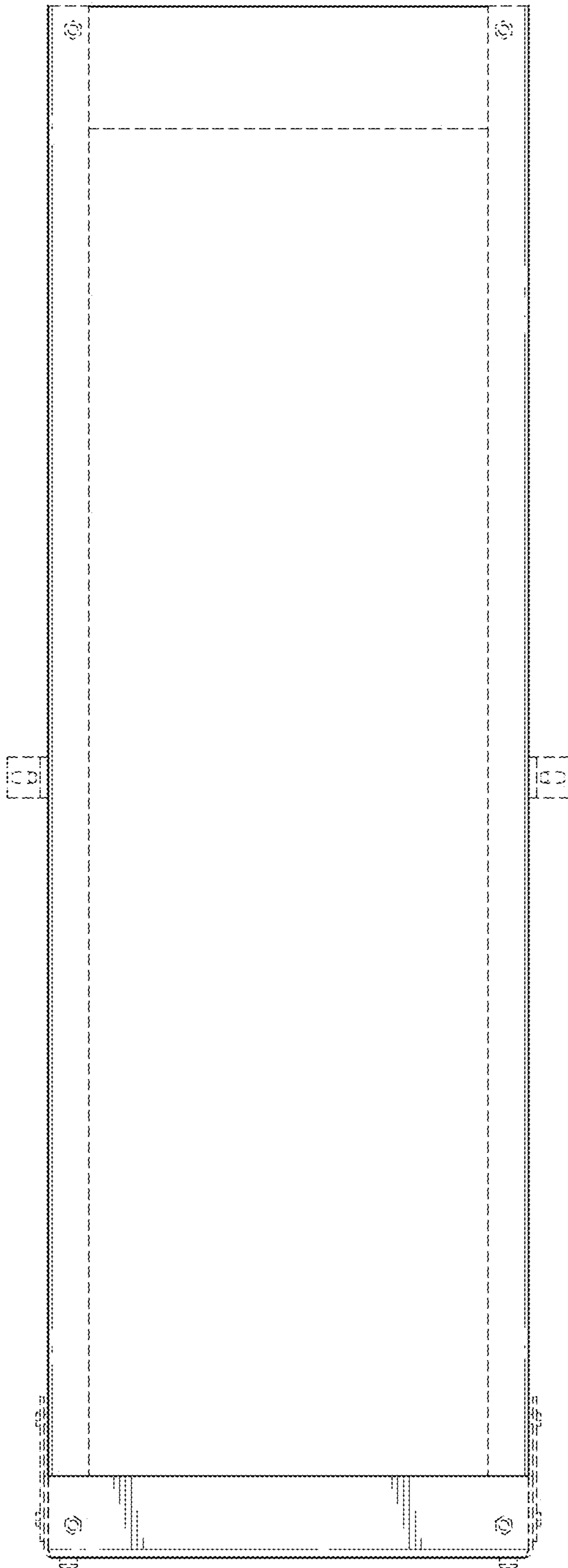

FIG. 10

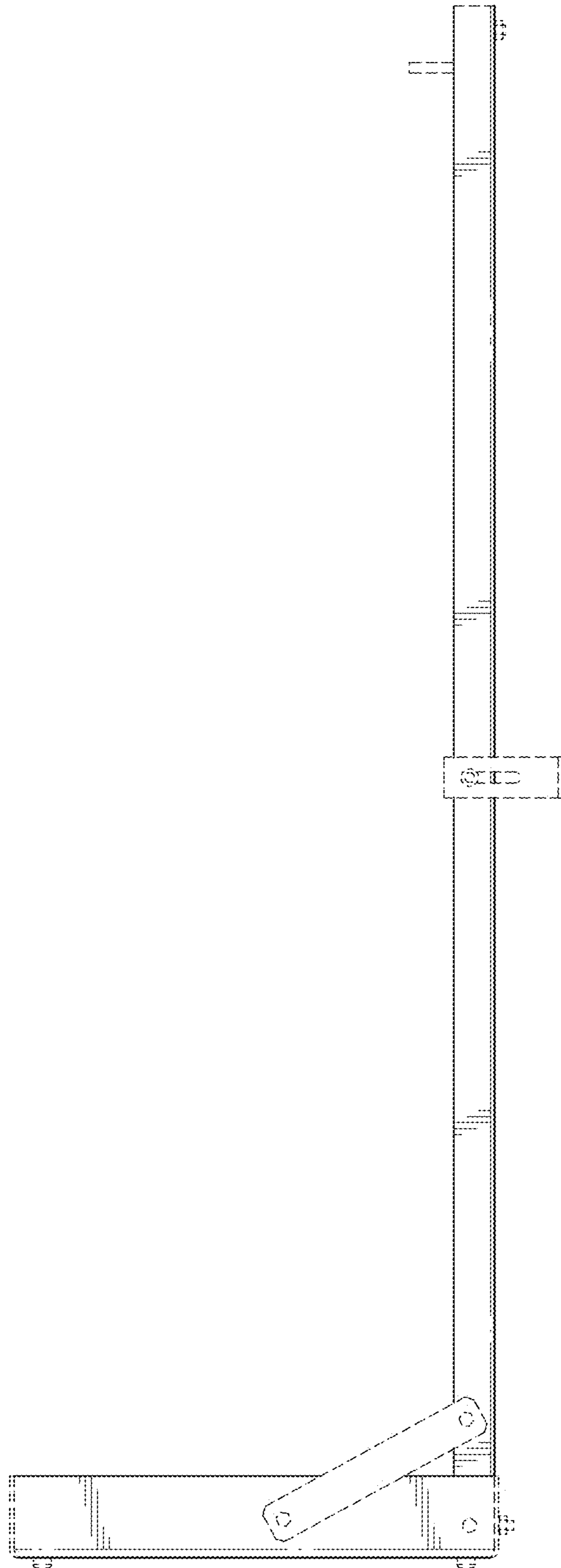

FIG. 11

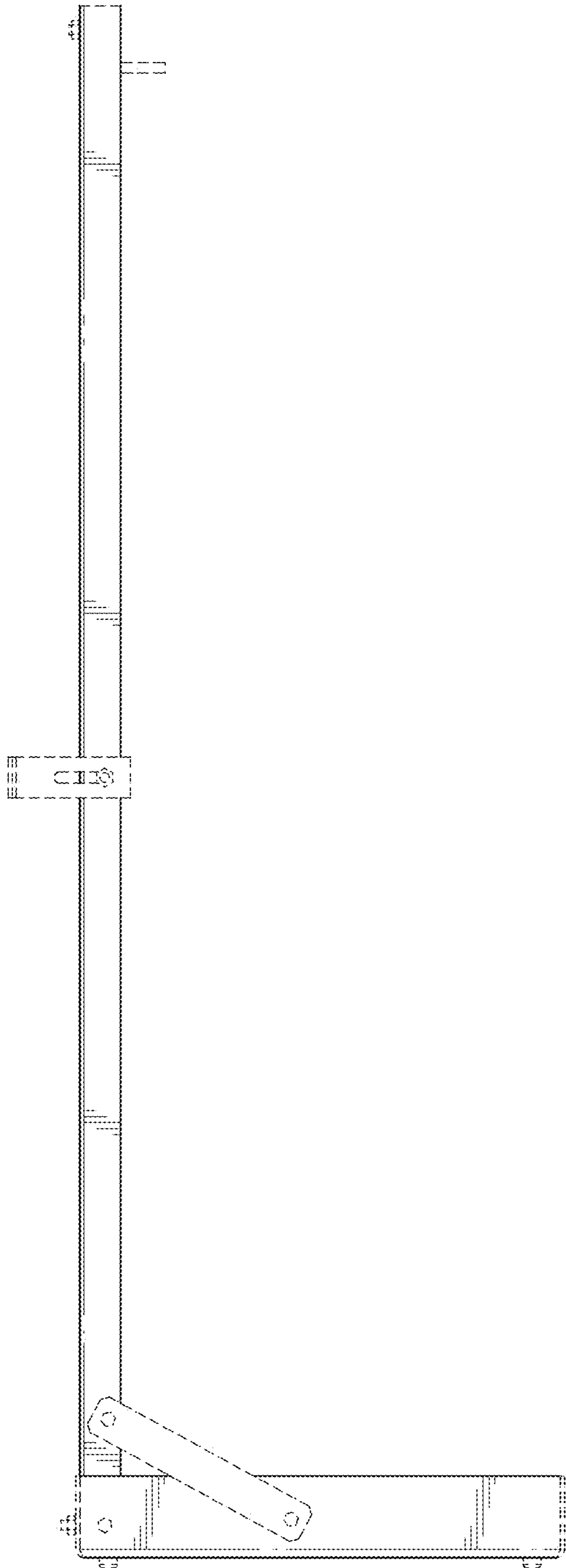

FIG. 12



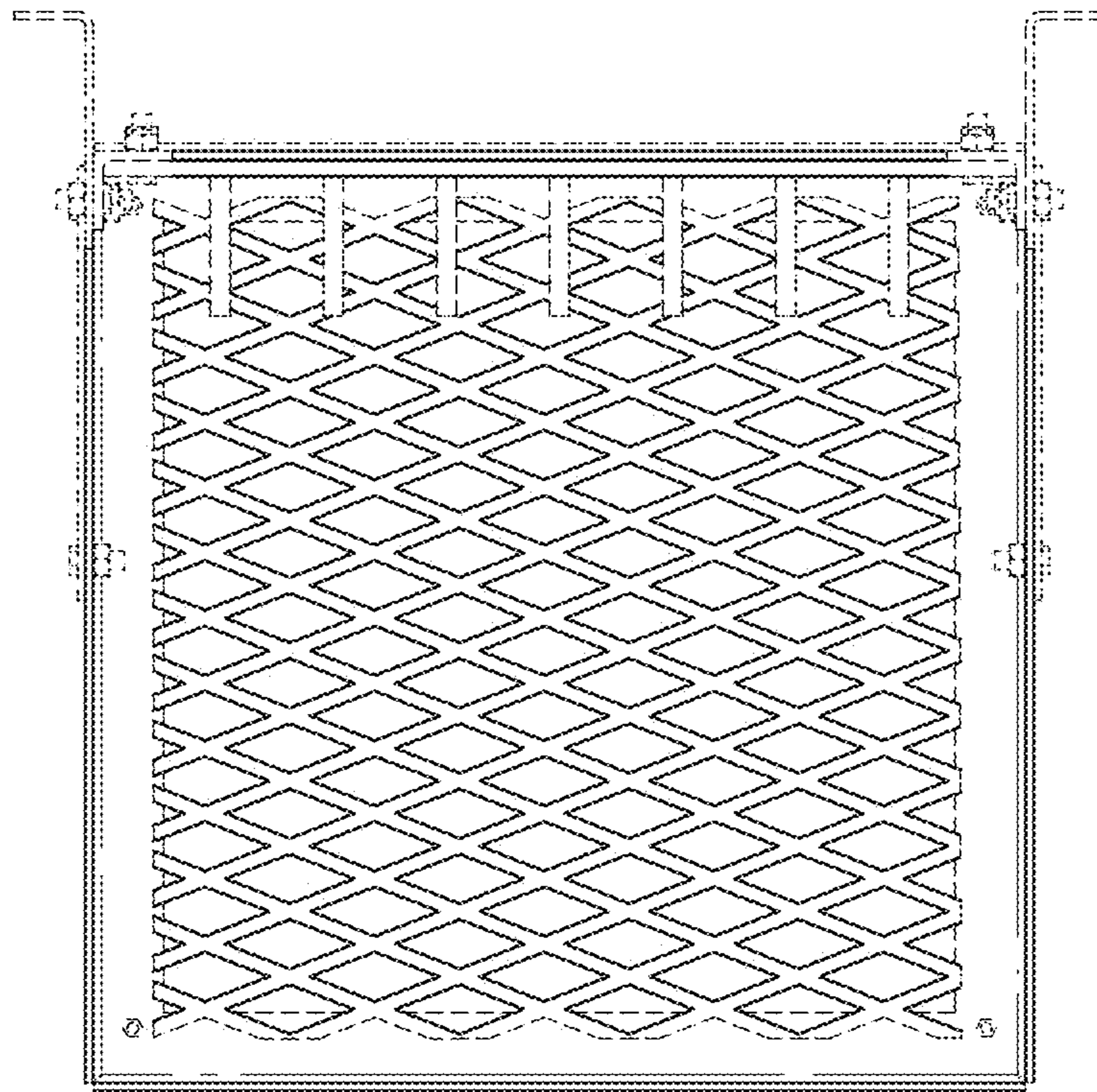

FIG. 13

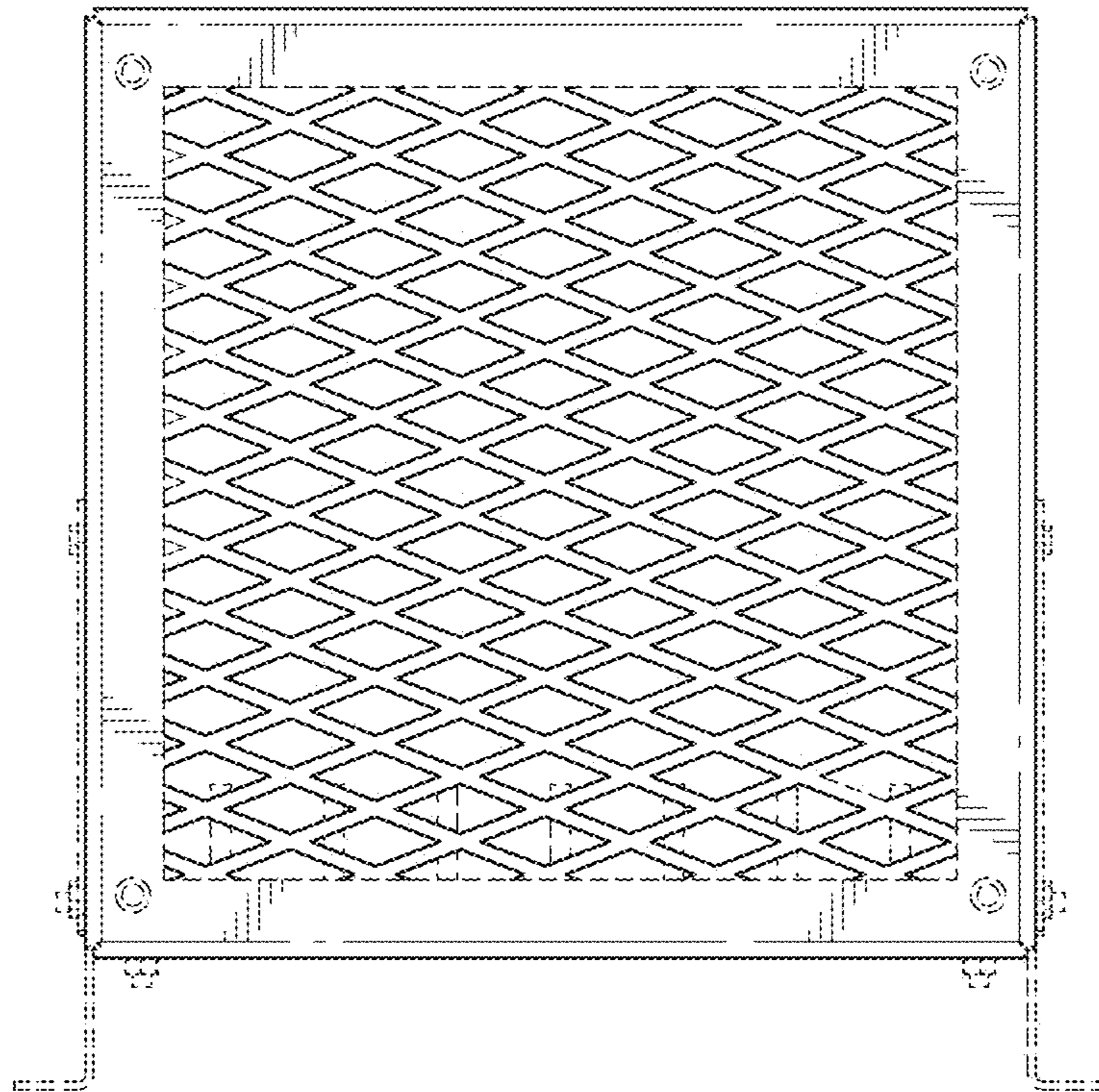

FIG. 14