



US00D882240S

(12) **United States Design Patent**
Khachatourian et al.

(10) **Patent No.:** **US D882,240 S**
(45) **Date of Patent:** **** Apr. 28, 2020**

- (54) **SHOE**
- (71) Applicant: **NIKE, Inc.**, Beaverton, OR (US)
- (72) Inventors: **Meline Khachatourian**, Portland, OR (US); **Jerry Lorenzo Manuel**, Los Angeles, CA (US)
- (73) Assignee: **NIKE, Inc.**, Beaverton, OR (US)
- (**) Term: **15 Years**
- (21) Appl. No.: **29/657,198**
- (22) Filed: **Jul. 19, 2018**
- (51) **LOC (12) Cl.** **02-04**
- (52) **U.S. Cl.**
USPC **D2/973**
- (58) **Field of Classification Search**
USPC D2/896, 902, 906-908, 946, 947, 969,
D2/972, 973, 974, 976
CPC A43B 5/00; A43B 13/181; A43B 13/141;
A43B 23/26; A43B 13/188; A43B 23/00
See application file for complete search history.

(56) **References Cited**

U.S. PATENT DOCUMENTS

D208,620 S *	9/1967	Werner	D2/946
D346,063 S *	4/1994	Clark	D10/128
D385,405 S *	10/1997	Lozano	D2/943
D512,826 S *	12/2005	Hatfield	D2/972
D738,086 S *	9/2015	Avar	D2/972
D867,745 S *	11/2019	Chang	D2/973

OTHER PUBLICATIONS

Acronym x Nike Air posted by Brian Betschart posted date Aug. 2, 2016, © Sneaker Files, [online], [site visited Jan. 20, 2020].

Available from Internet, <https://www.sneakerfiles.com/acronym-nike-air-presto-olive/> (Year: 2016).*
Fear of God x Nike Air posted by Brian Betschart posted date Dec. 10, 2018, © Sneaker Files, [online], [site visited Jan. 20, 2020]. Available from Internet, <https://www.sneakerfiles.com/nike-air-fear-of-god-shoot-around-at9915-001-release-date/> (Year: 2018).*
Jerry Lorenzo Fear of God posted by Complex News posted date Nov. 13, 2018, © Youtube, [online], [site visited Jan. 20, 2020]. Available from Internet, https://www.youtube.com/watch?v=0H-rJijFlo&feature=emb_logo (Year: 2018).*

* cited by examiner

Primary Examiner — Michael C Stout

Assistant Examiner — Laura H Yu

(74) *Attorney, Agent, or Firm* — Banner & Witcoff, Ltd.

(57) **CLAIM**

The ornamental design for a shoe, as shown and described.

DESCRIPTION

FIG. 1 is a front perspective view of a shoe showing our new design;
FIG. 2 is a side view thereof;
FIG. 3 is an opposite side view thereof;
FIG. 4 is a front view thereof;
FIG. 5 is a rear view thereof; and,
FIG. 6 is a top view thereof.
The broken lines immediately adjacent to the shaded areas define the bounds of the claimed design and form no part thereof. The broken line rectangles, zipper and pull within the shaded areas form no part of the claimed design. The unshaded area in FIG. 6 corresponding to the inner surface of the strap forms no part of the claimed design. The broken lines depicting the remainder of the shoe show features that form no part of the claimed design.

1 Claim, 6 Drawing Sheets

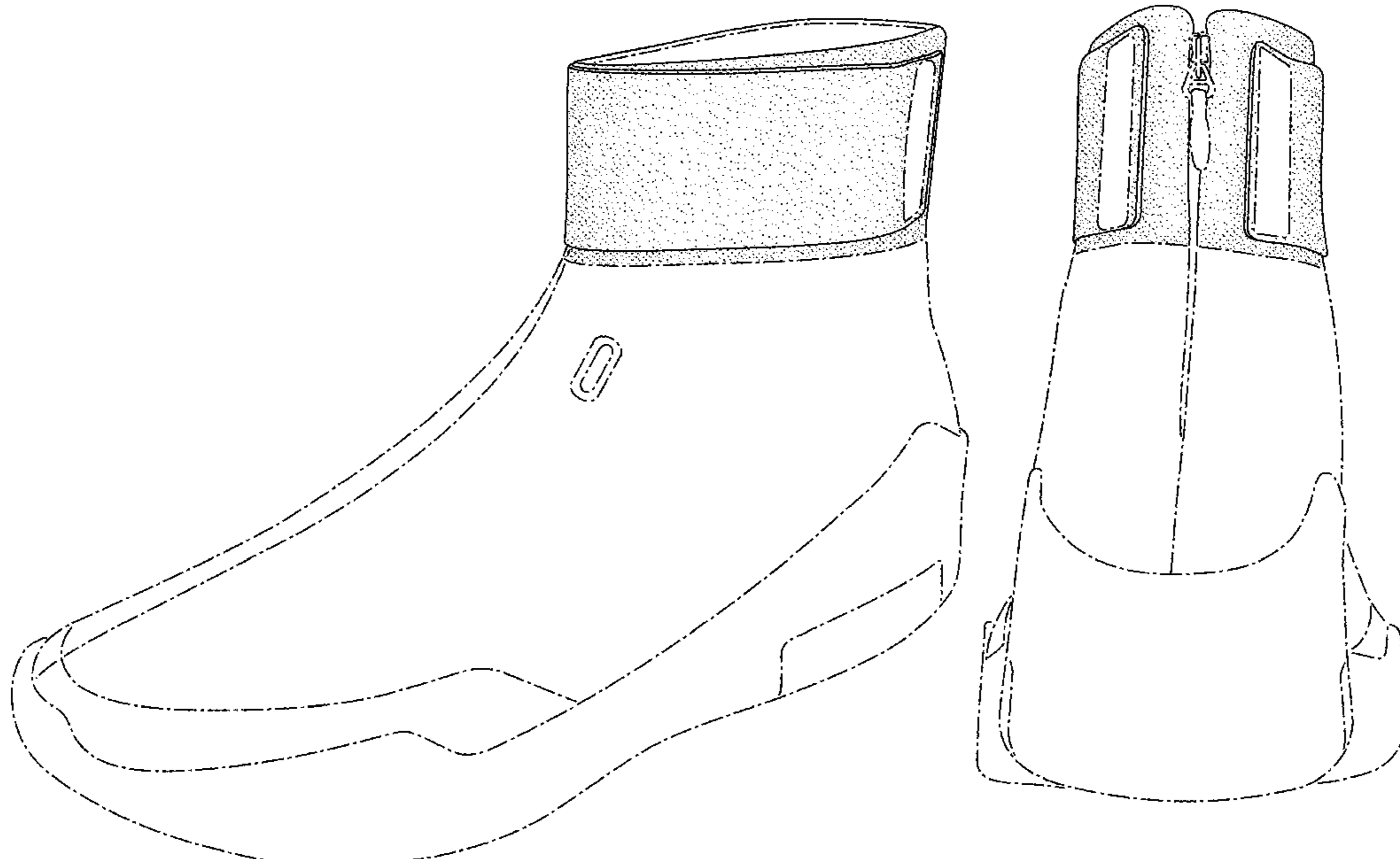

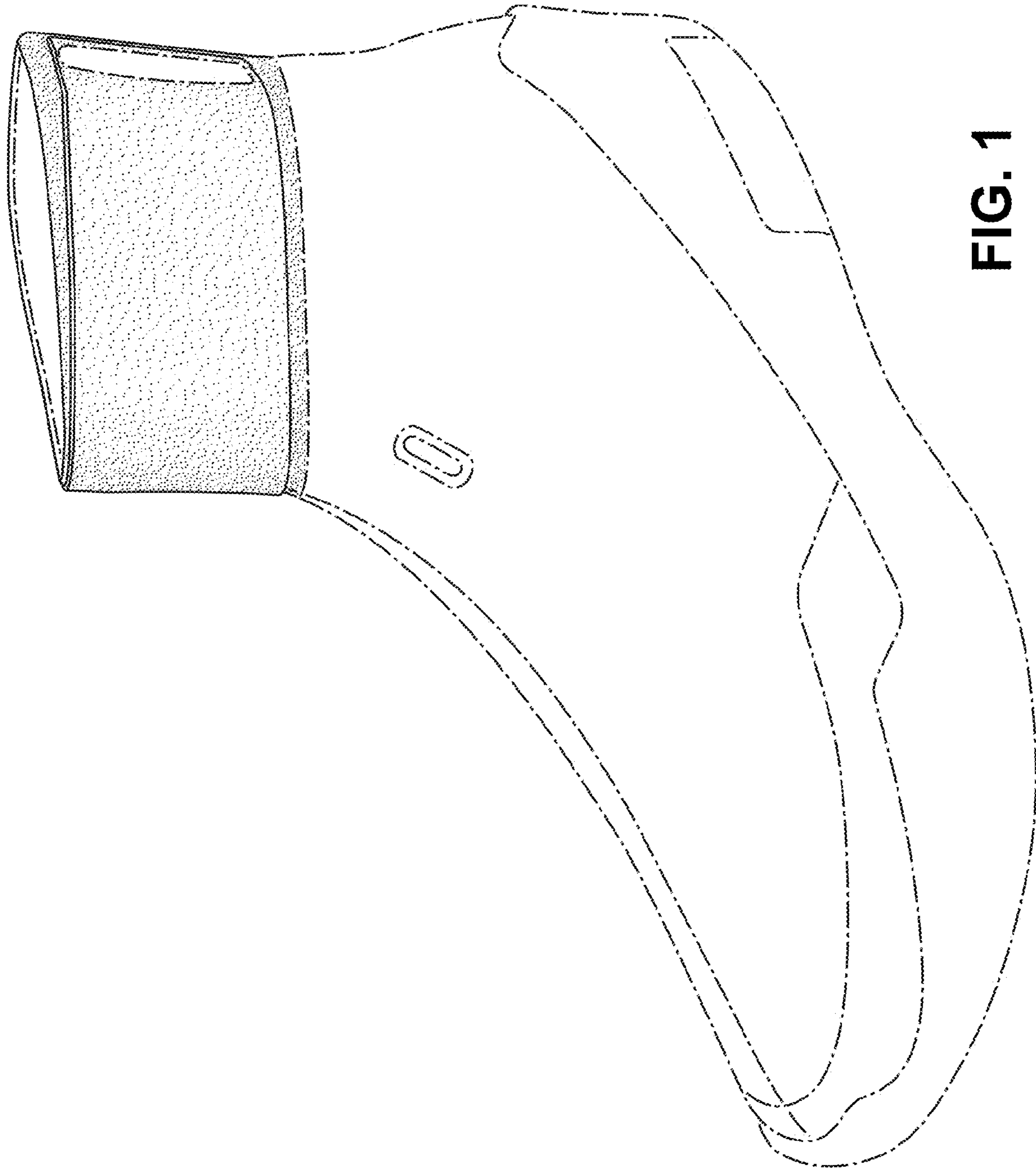

FIG. 1

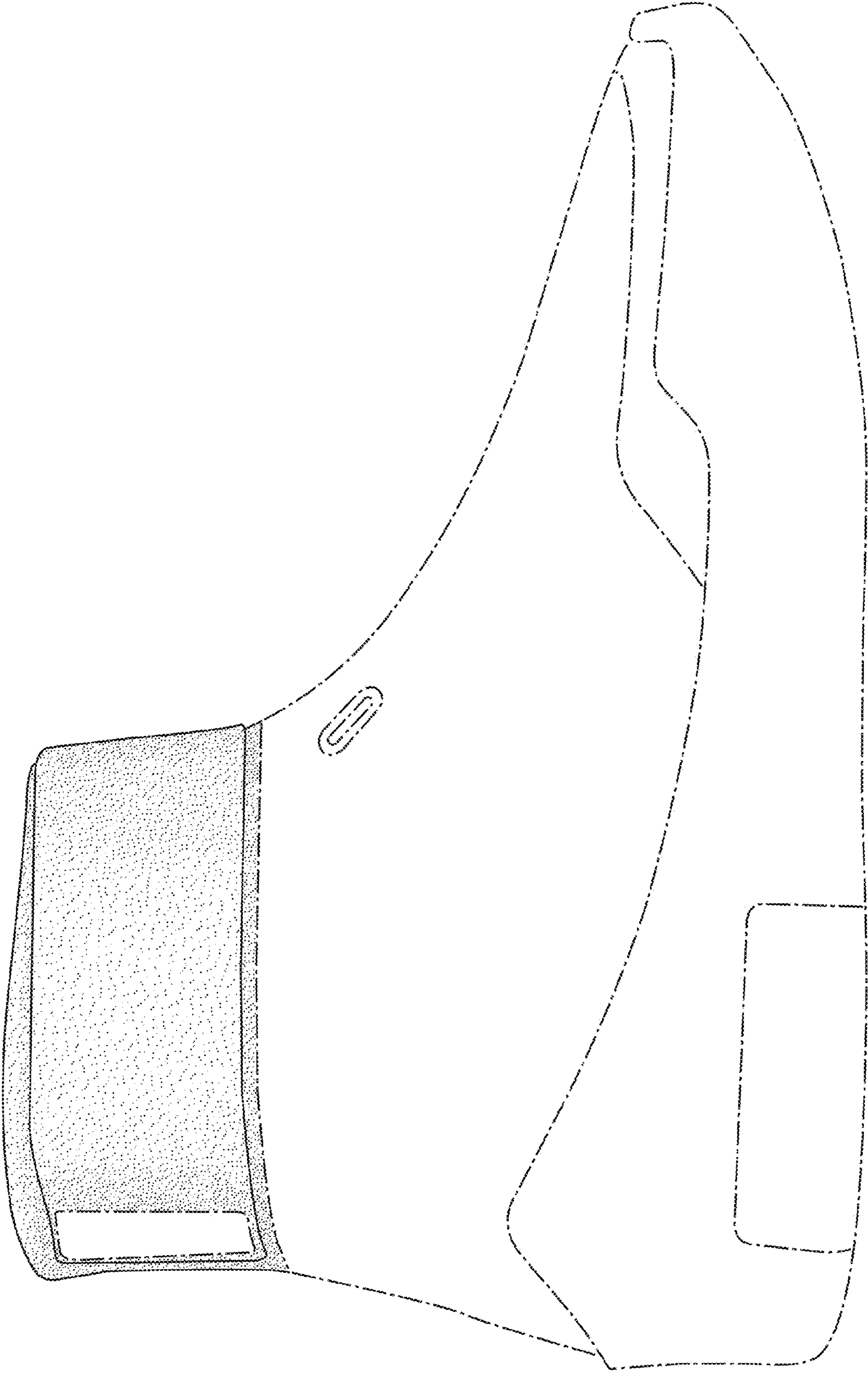

FIG. 2

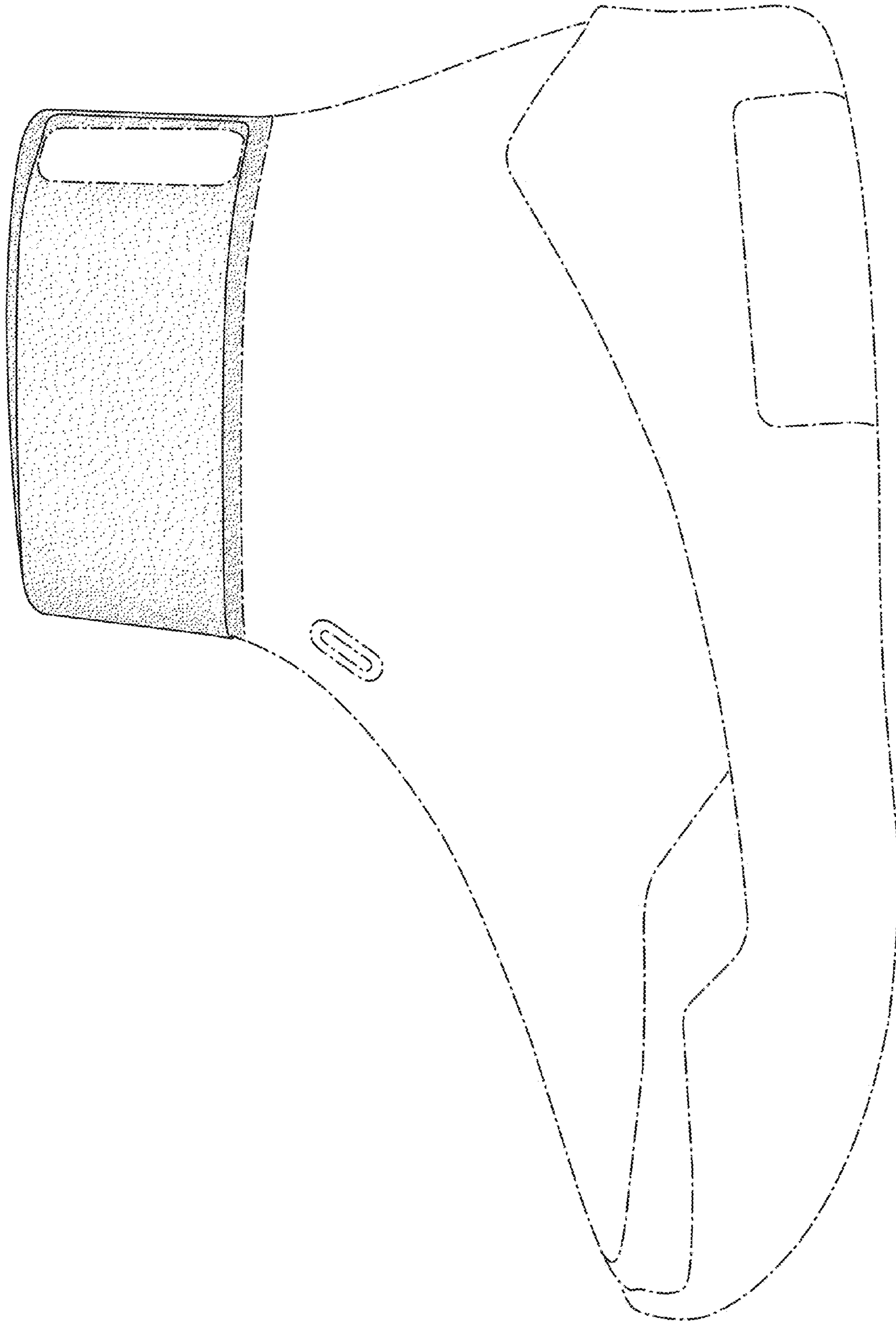

FIG. 3

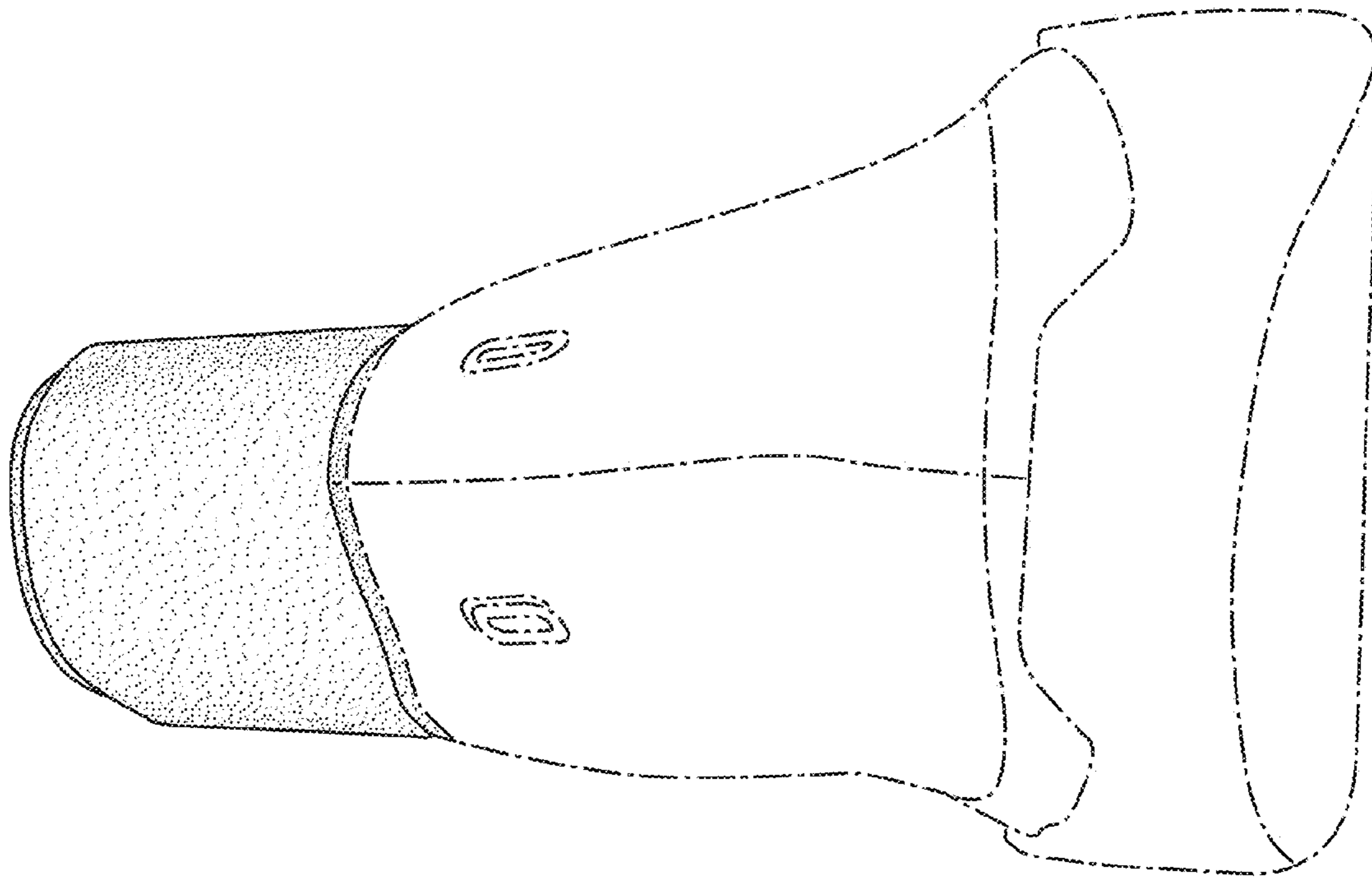

FIG. 4

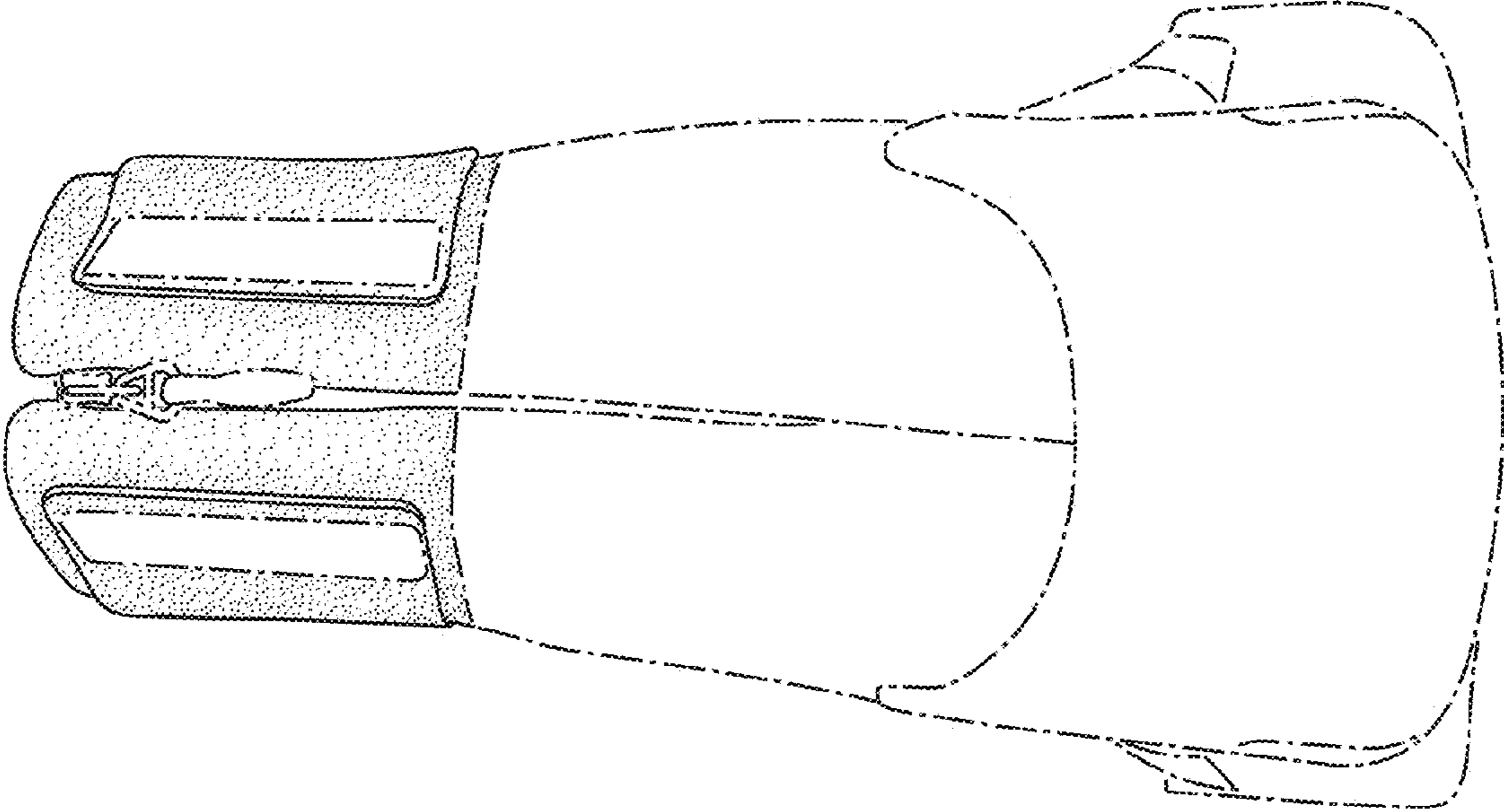

FIG. 5

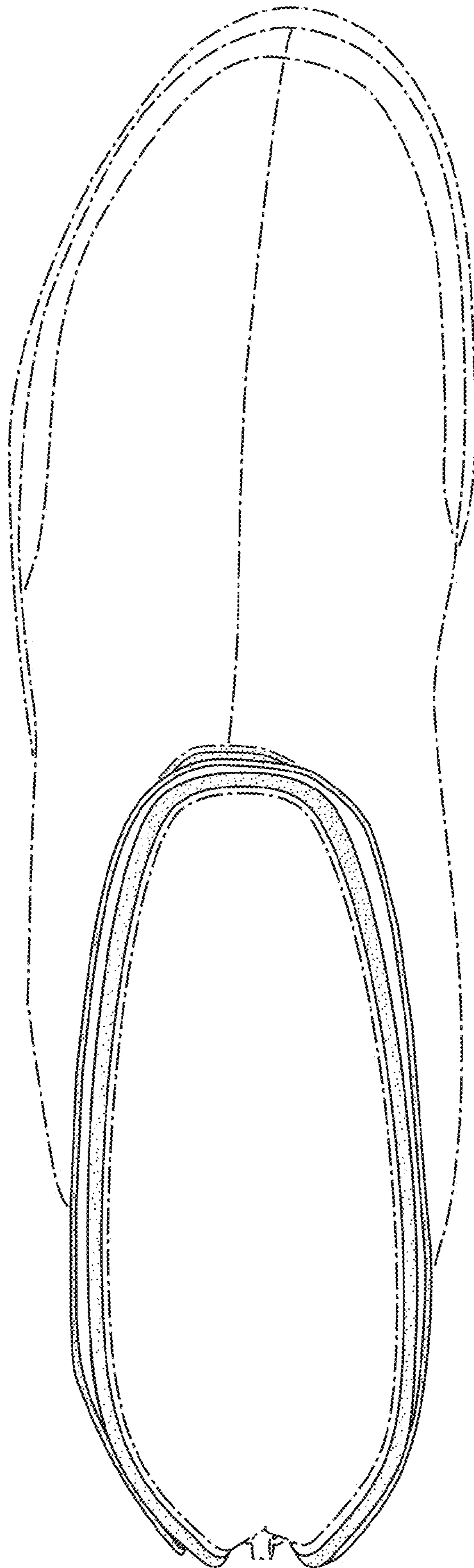

FIG. 6