



US00D882209S

(12) **United States Design Patent** (10) **Patent No.:** **US D882,209 S**
Peters (45) **Date of Patent:** **** Apr. 28, 2020**

(54) **PAIR OF PANTS**

(74) *Attorney, Agent, or Firm* — Morgan, Lewis & Bockius LLP

(71) Applicant: **The Gap, Inc.**, Albuquerque, NM (US)

(72) Inventor: **Jeannette Peters**, San Pablo, CA (US)

(57) **CLAIM**

(73) Assignee: **The Gap, Inc.**, San Francisco, CA (US)

The ornamental design for a pair of pants, as shown and described.

(**) Term: **15 Years**

(21) Appl. No.: **29/648,872**

DESCRIPTION

(22) Filed: **May 24, 2018**

(51) **LOC (12) Cl.** **02-02**

(52) **U.S. Cl.**
USPC **D2/742; D2/731**

(58) **Field of Classification Search**
USPC D2/742–743, 728, 731; 2/79
CPC A41D 1/06; A41D 1/08
See application file for complete search history.

FIG. 1 is a rear perspective view of a pair of pants showing our new design in an in-use configuration; FIG. 2 is an enlarged fragmentary view of FIG. 1; FIG. 3 is a rear elevational view of FIG. 1; FIG. 4 is an enlarged fragmentary view of FIG. 3; FIG. 5 is a front elevational view of FIG. 1; FIG. 6 is an enlarged fragmentary view of FIG. 5; FIG. 7 is a right elevational view of FIG. 1; FIG. 8 is an enlarged view fragmentary view of FIG. 7; FIG. 9 is a left elevational view of FIG. 1; FIG. 10 is an enlarged fragmentary view of FIG. 9; FIG. 11 is a front elevational view of FIG. 1; FIG. 12 is a cross-sectional view taken along the line 12-12 of FIG. 11. FIG. 13 is an enlarged fragmentary view of FIG. 12; FIG. 14 is a top plan view of FIG. 1; FIG. 15 is a bottom plan view of FIG. 1; and FIG. 16 is an enlarged bottom plan view of FIG. 1; and FIG. 17 is an enlarged fragmentary view of FIG. 16. The stippling shown in the Figures indicates a contrast in appearance, where the contrast is a different pattern or a different color than the non-stippled portions of the pair of pants. The broken lines showing elements in the above described Figures are understood to be unclaimed environmental subject matter.

(56) **References Cited**

U.S. PATENT DOCUMENTS

1,861,704	A *	6/1932	Manke	A41D 1/06
					2/227
D269,135	S *	5/1983	Langmyr	D2/742
D273,434	S *	4/1984	Galbreath	2/227
D423,191	S *	4/2000	McCormick	D2/742
D507,392	S *	7/2005	Sieber	D2/742
D598,178	S *	8/2009	Cutlip	D2/742
D734,920	S *	7/2015	Korman	D2/742
D751,273	S *	3/2016	Ramon	D2/742
D794,908	S *	8/2017	Schneider	D2/731
D807,616	S *	1/2018	Komulainen	D2/742
D822,345	S *	7/2018	Swersky	D2/731

* cited by examiner

Primary Examiner — Catherine R Oliver-Garcia

Assistant Examiner — J. Thorn, Sr.

1 Claim, 16 Drawing Sheets

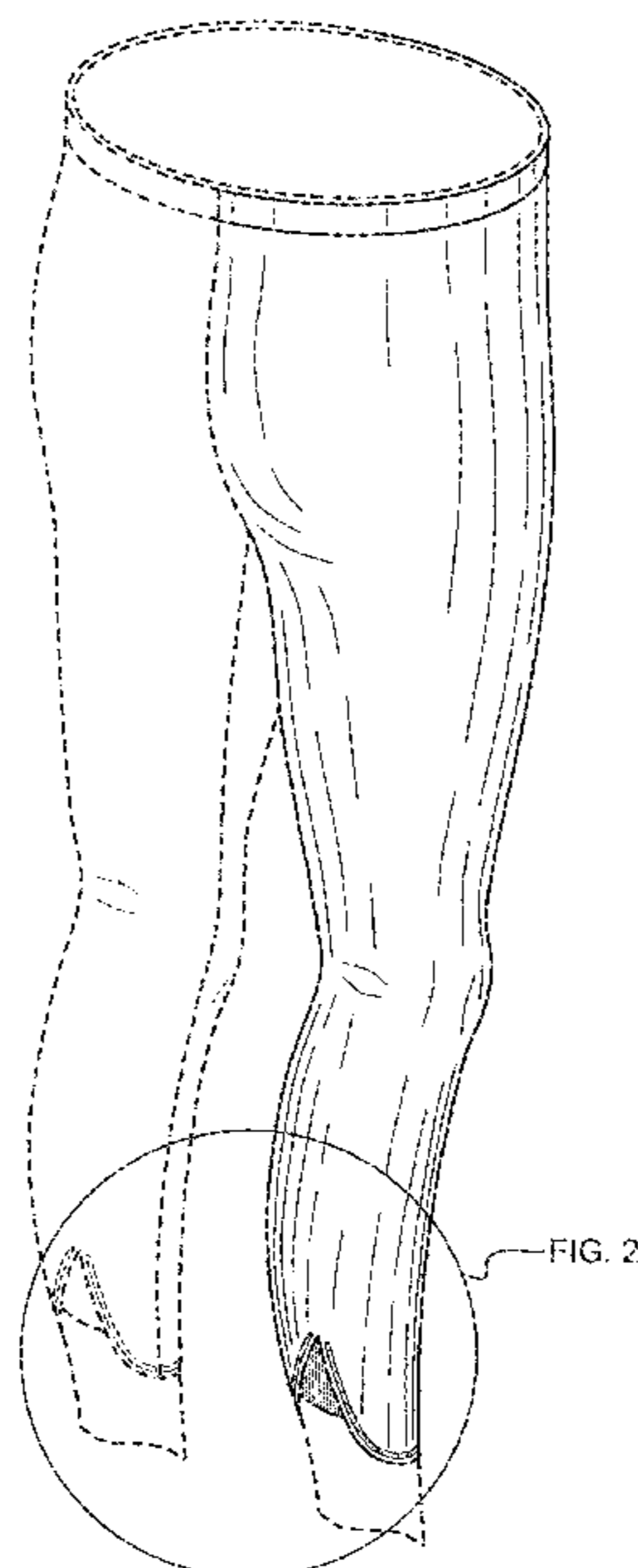

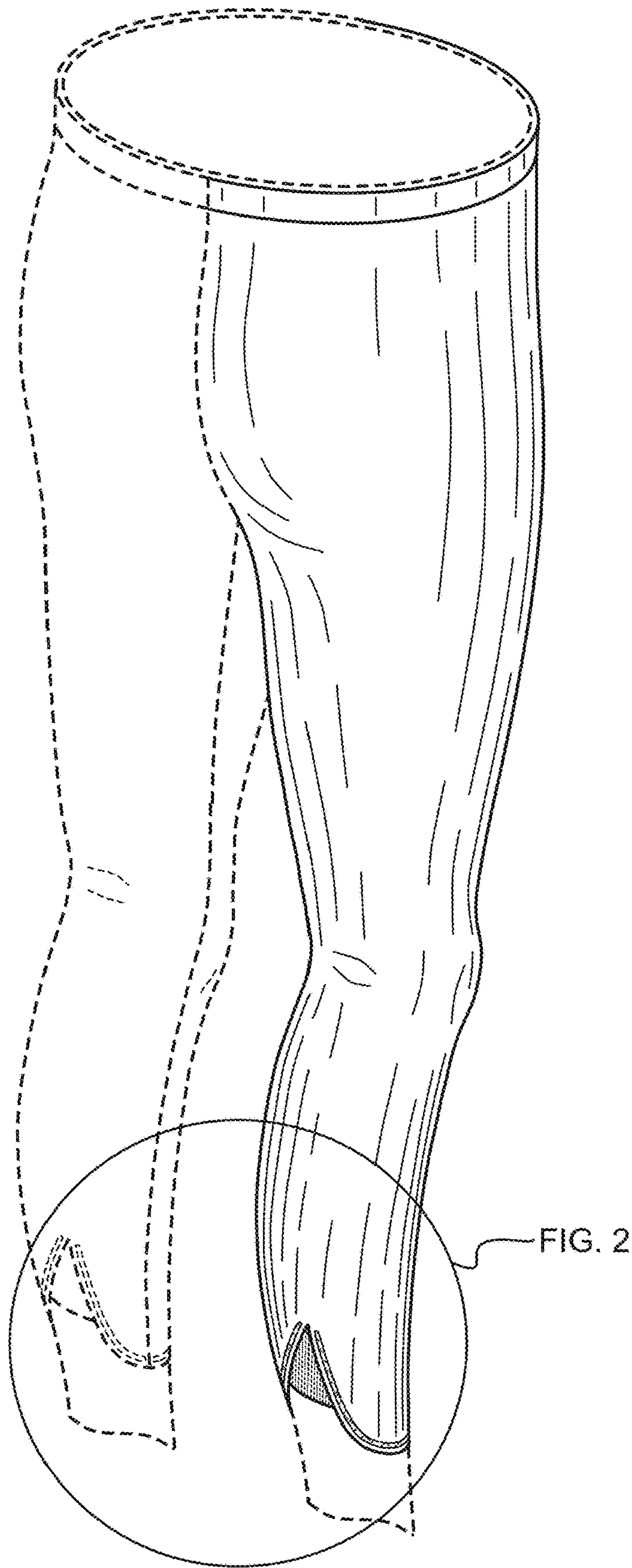

FIG. 1

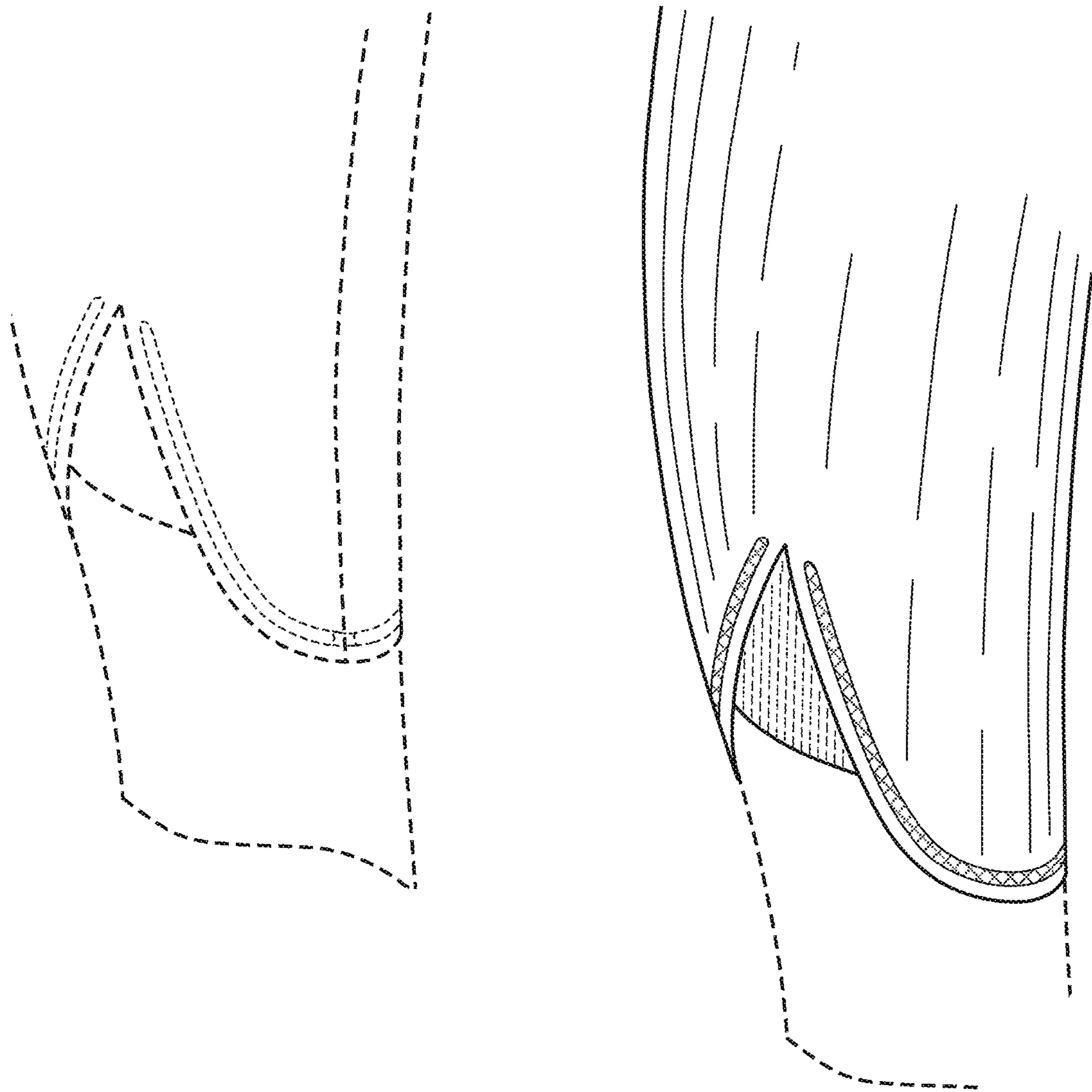

FIG. 2

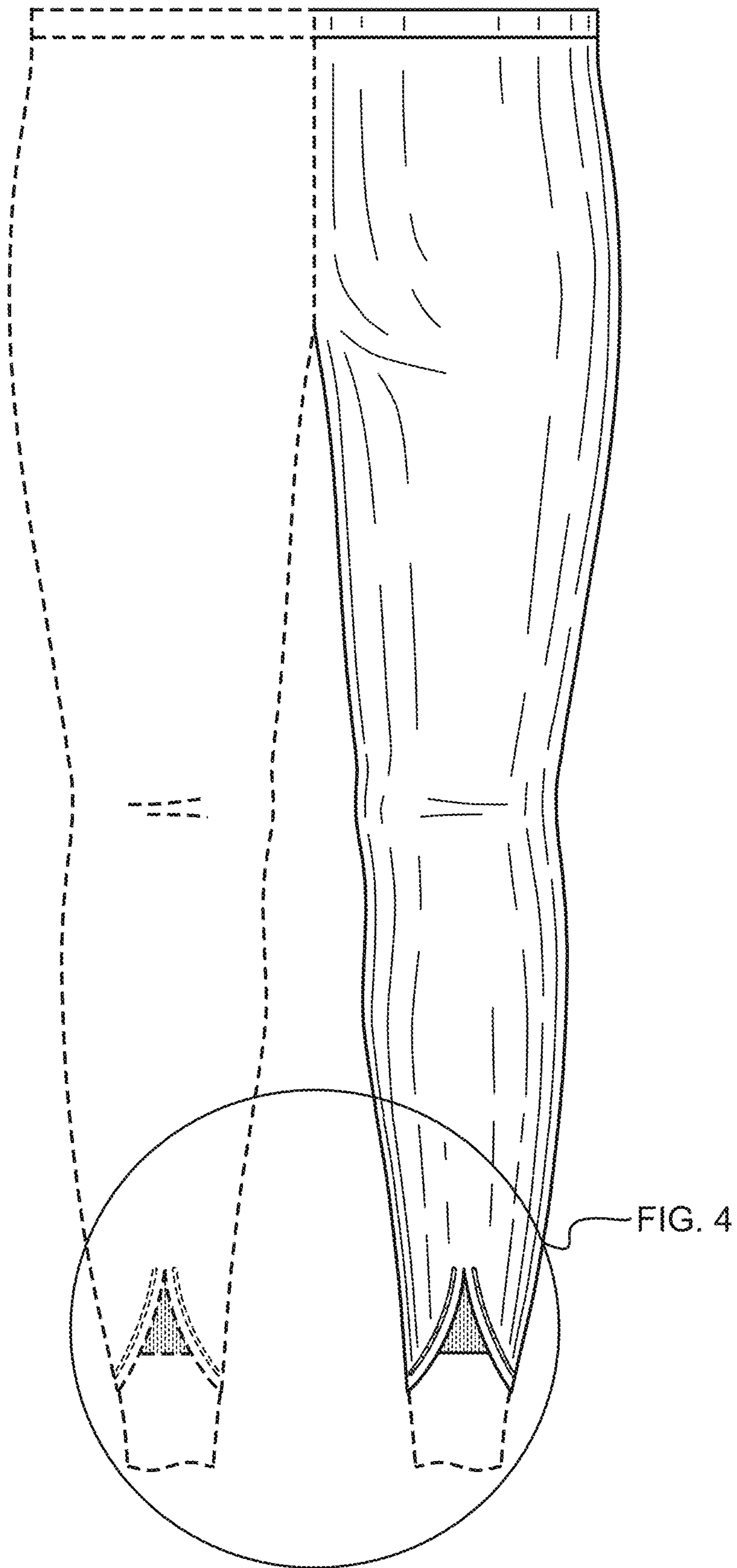

FIG. 3

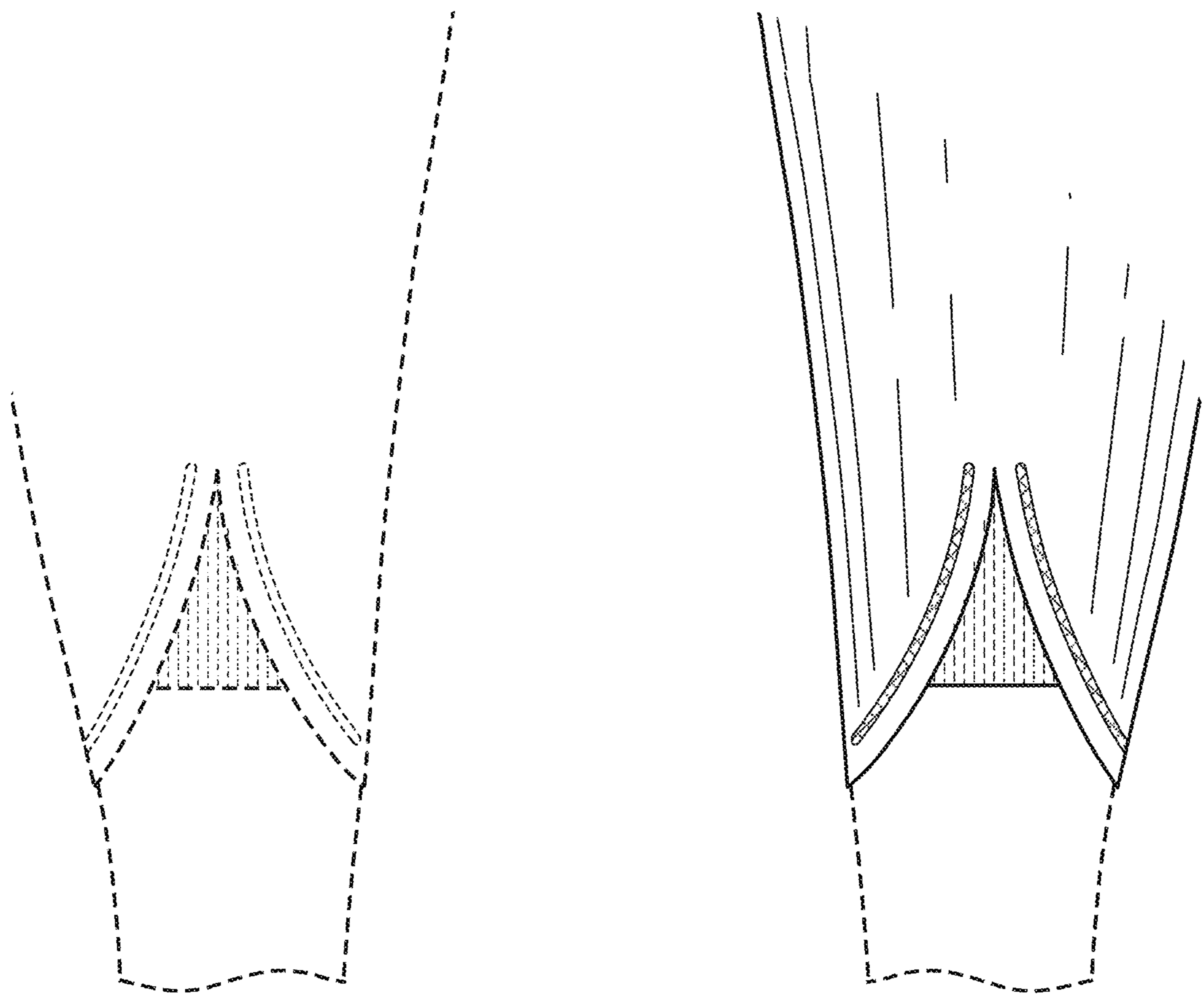

FIG. 4

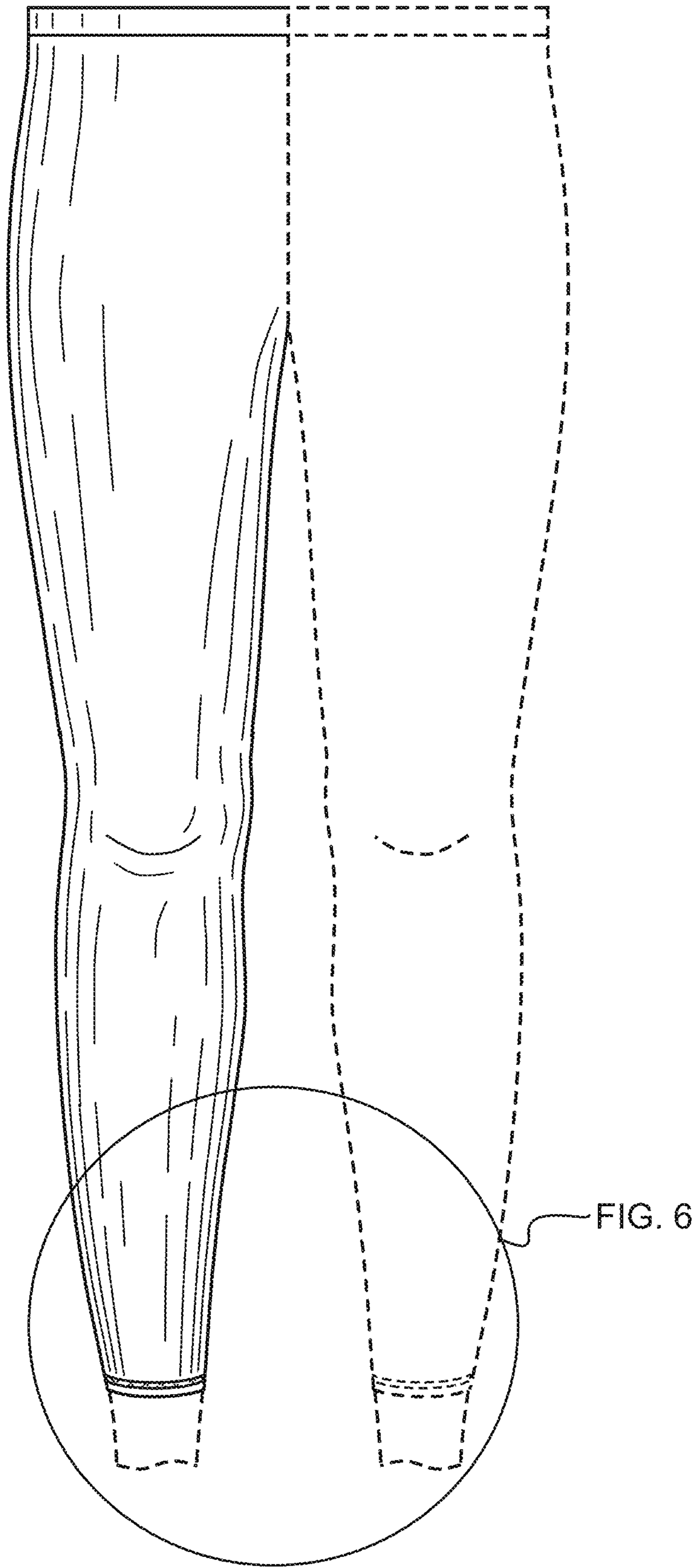

FIG. 5

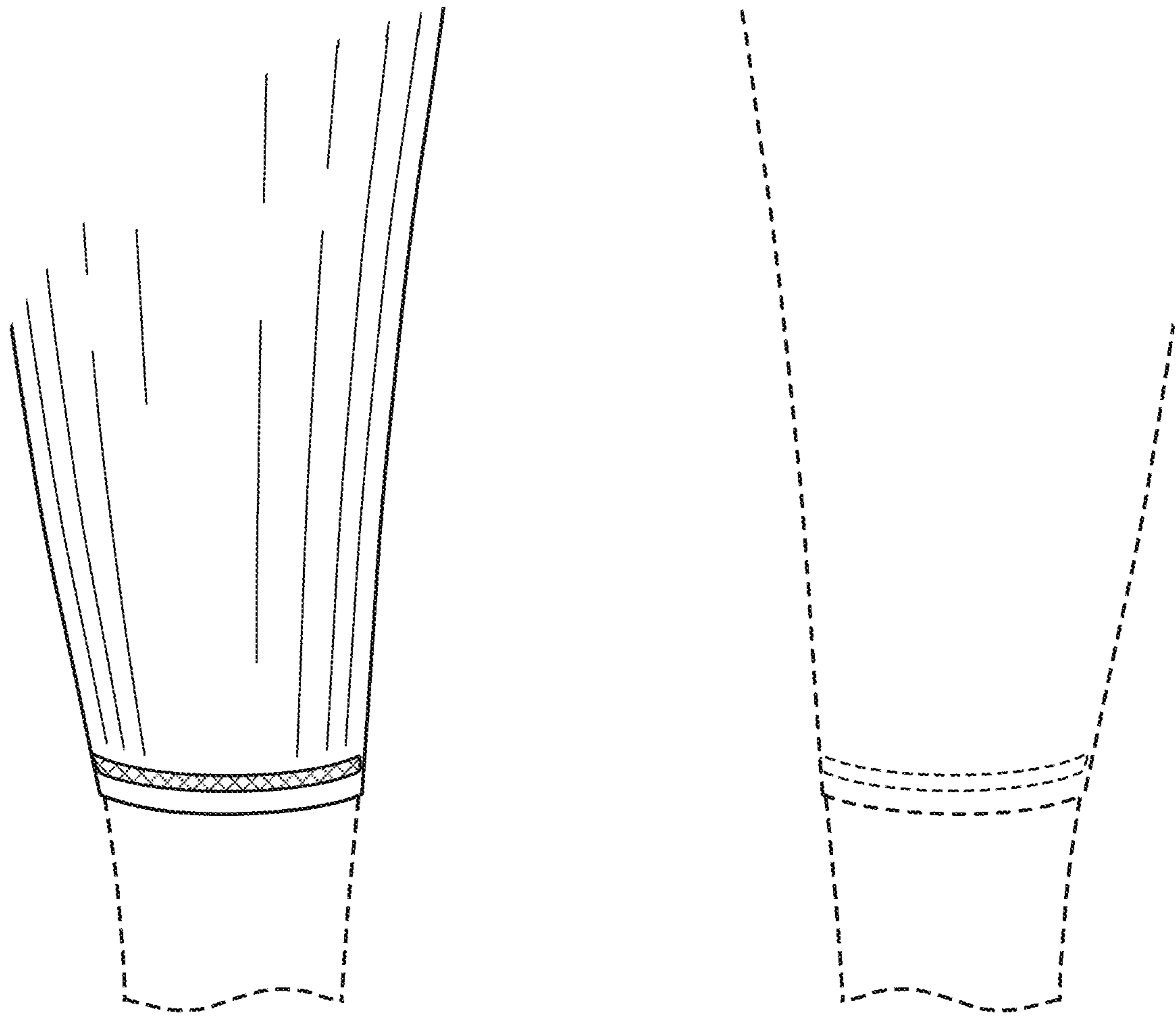

FIG. 6

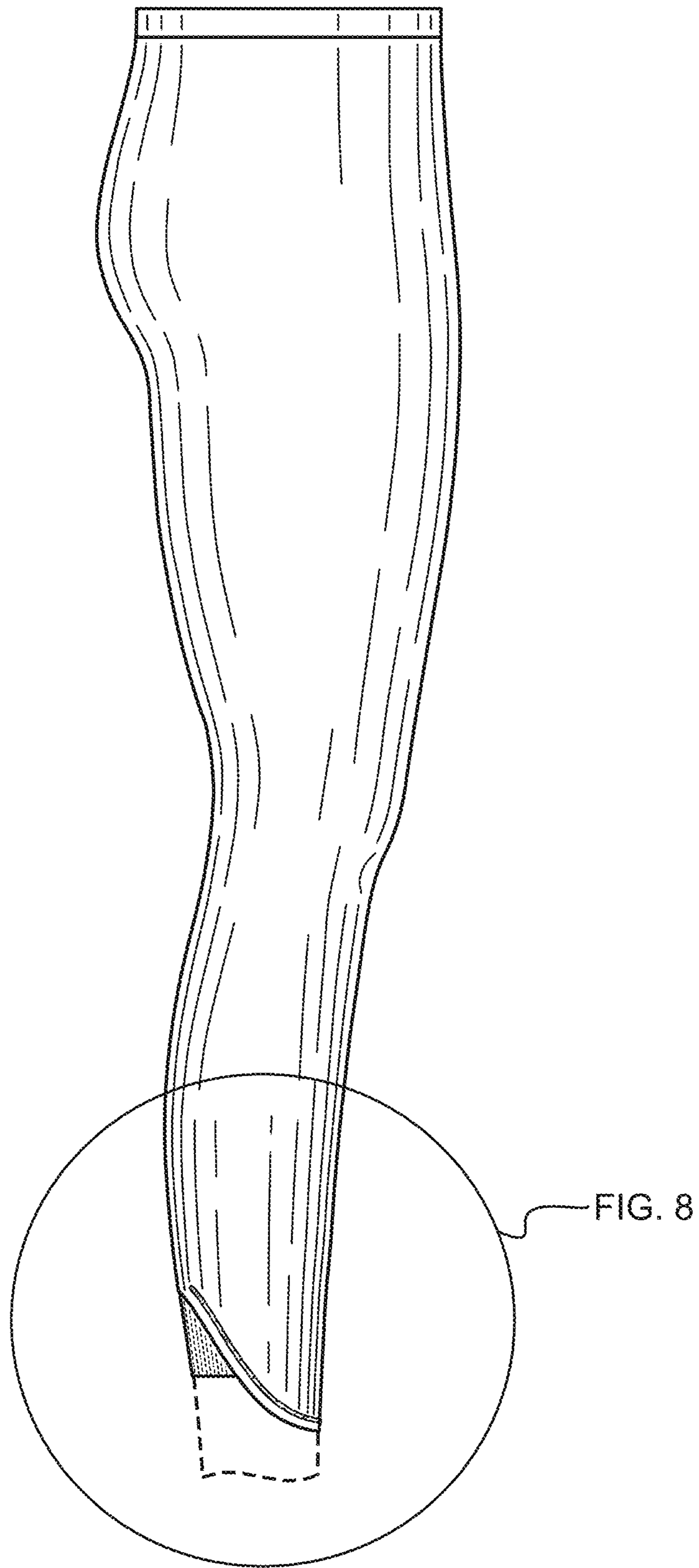

FIG. 7

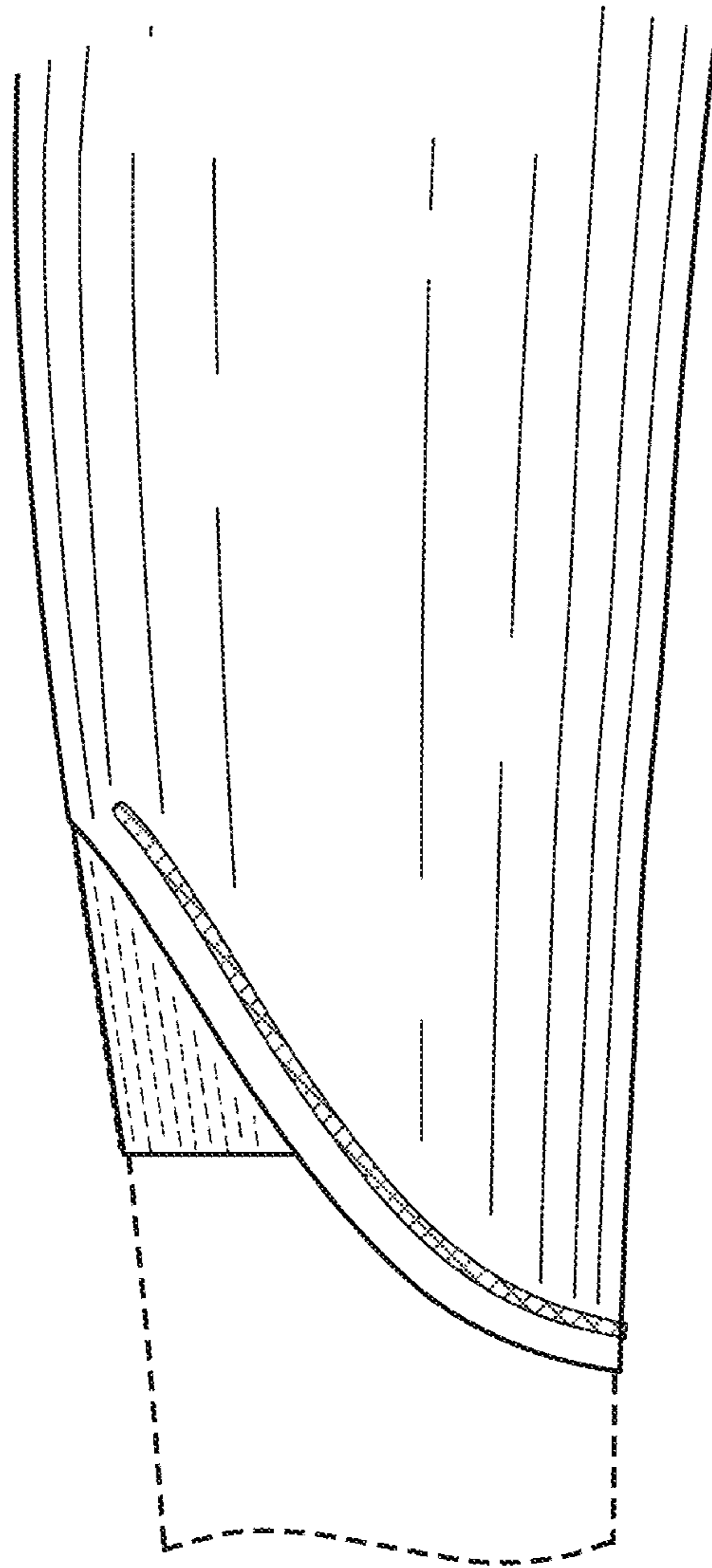

FIG. 8

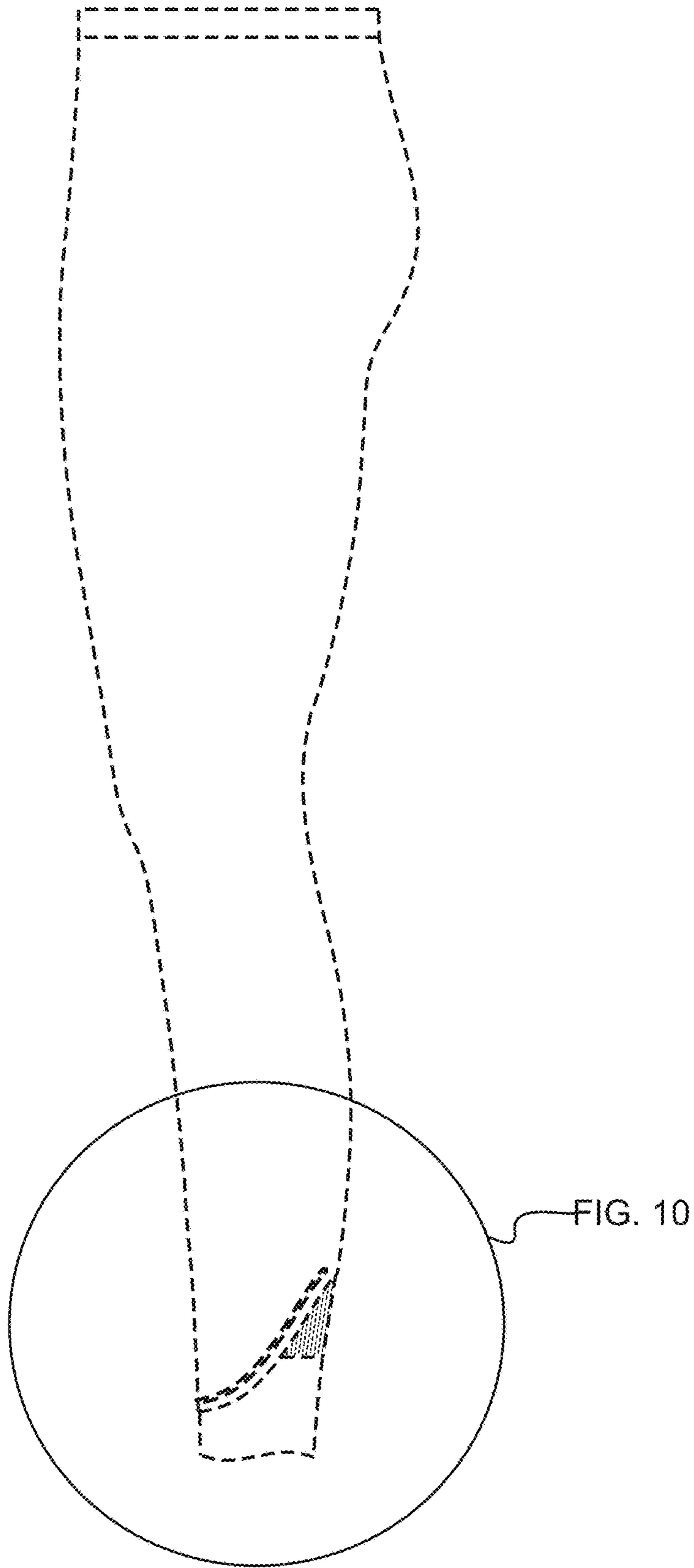

FIG. 9

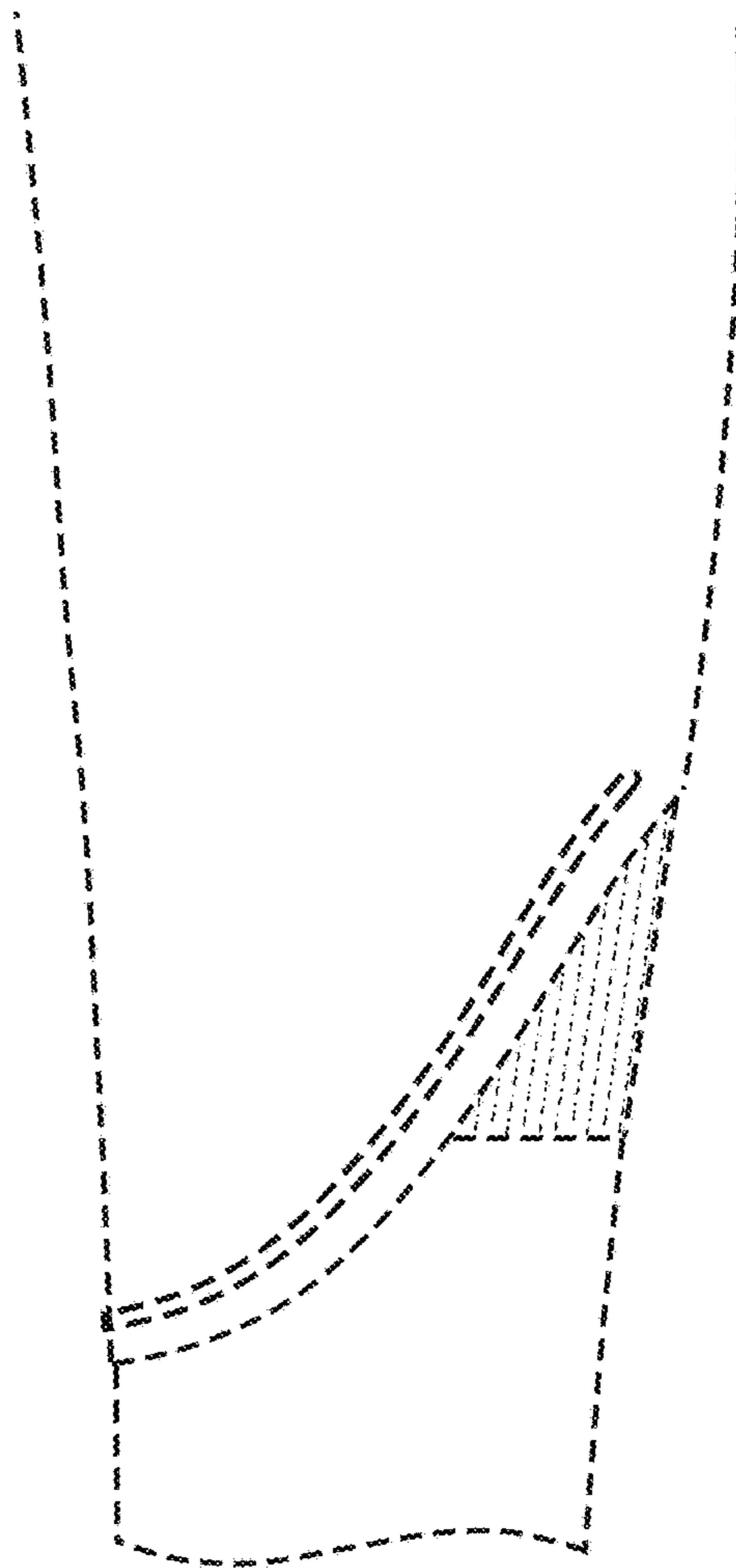

FIG. 10

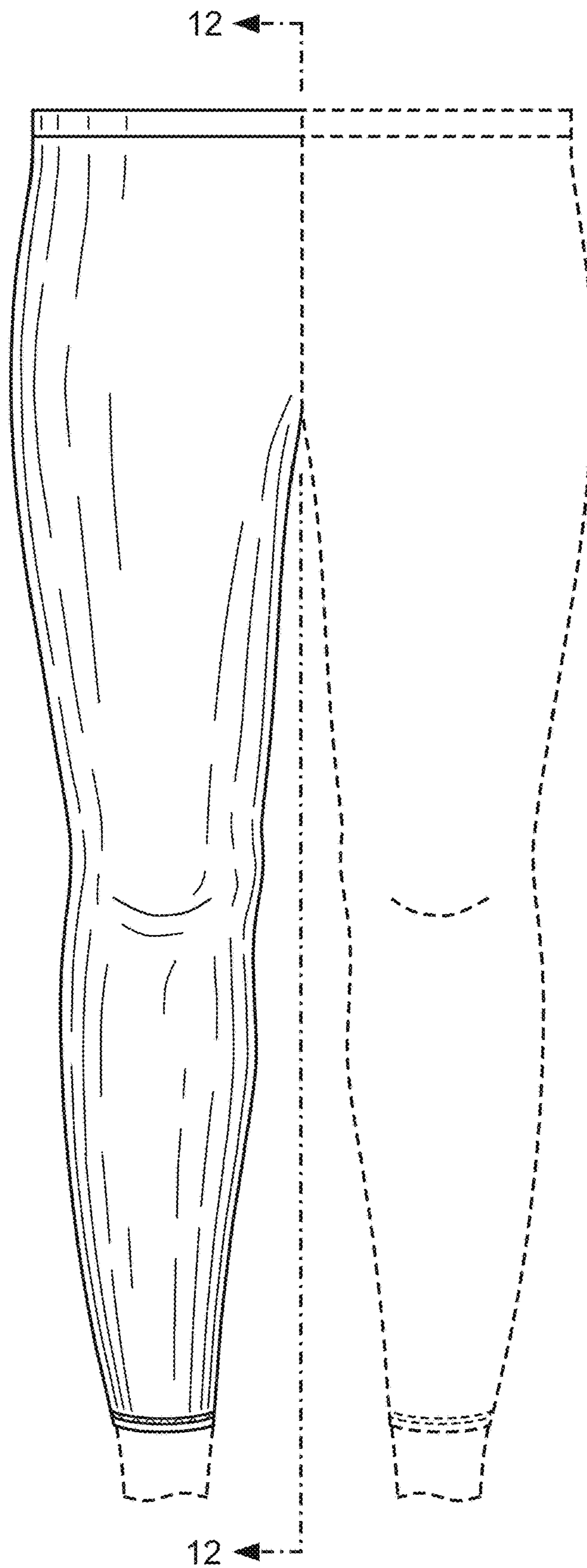

FIG. 11



FIG. 12

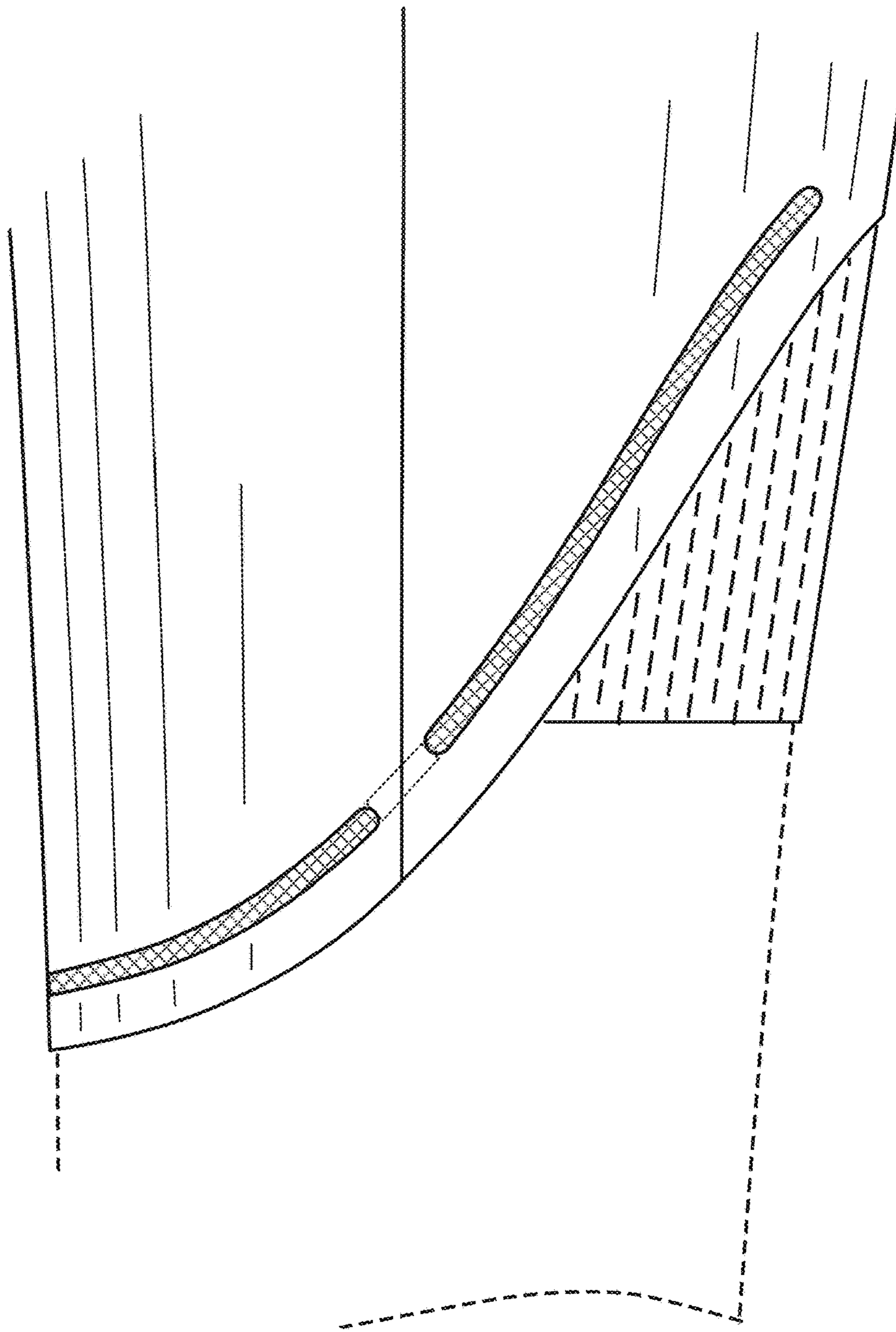

FIG. 13

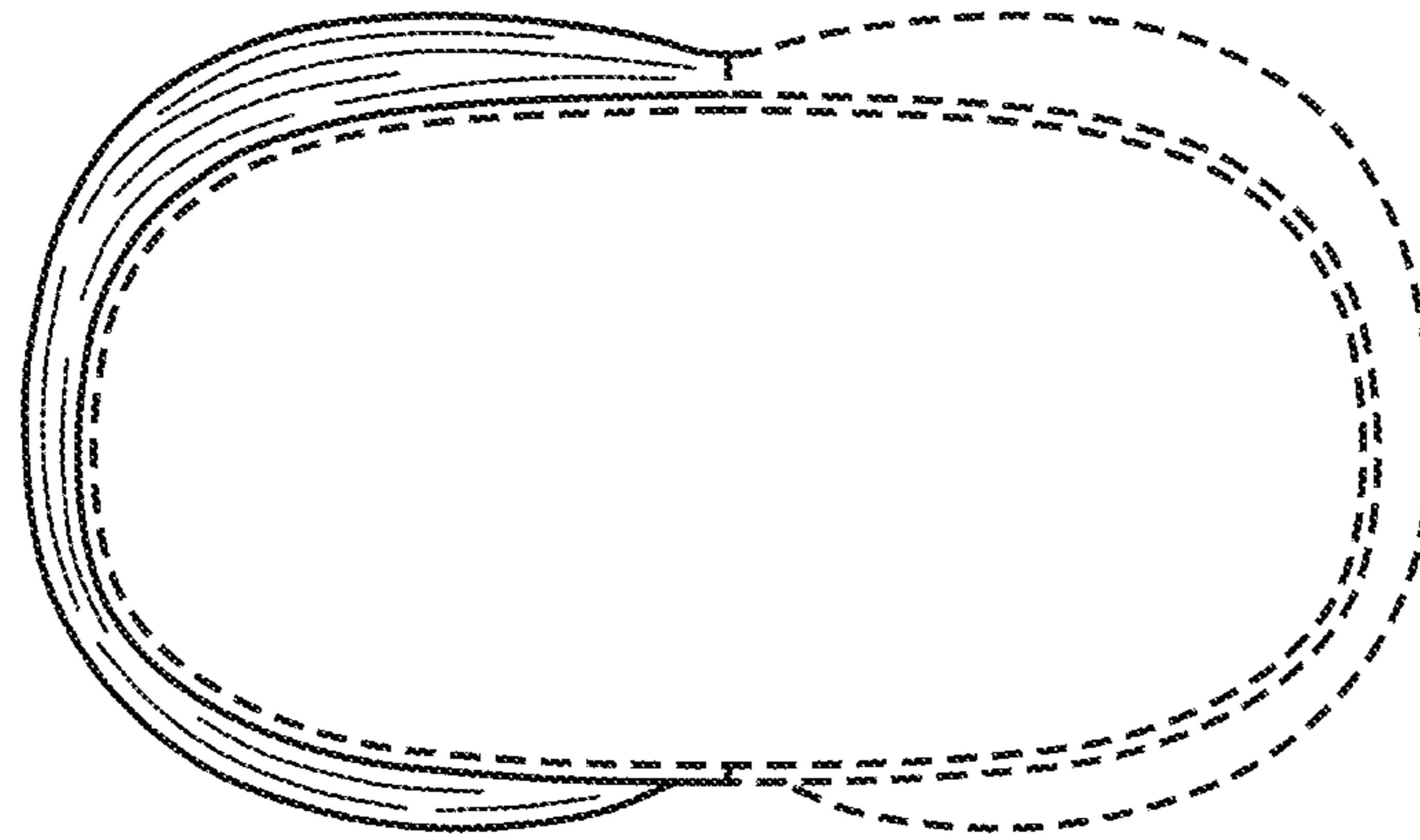

FIG. 14

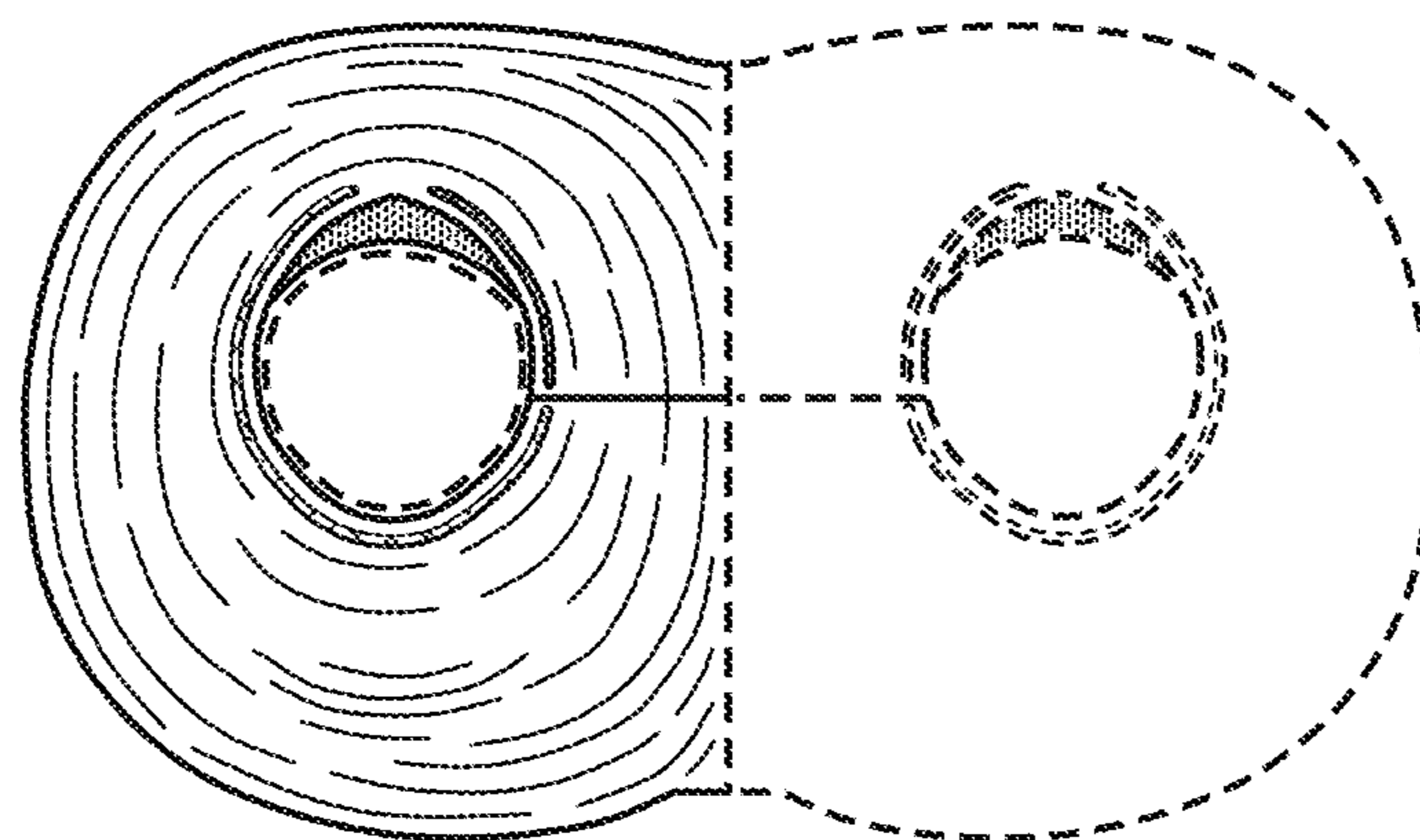

FIG. 15

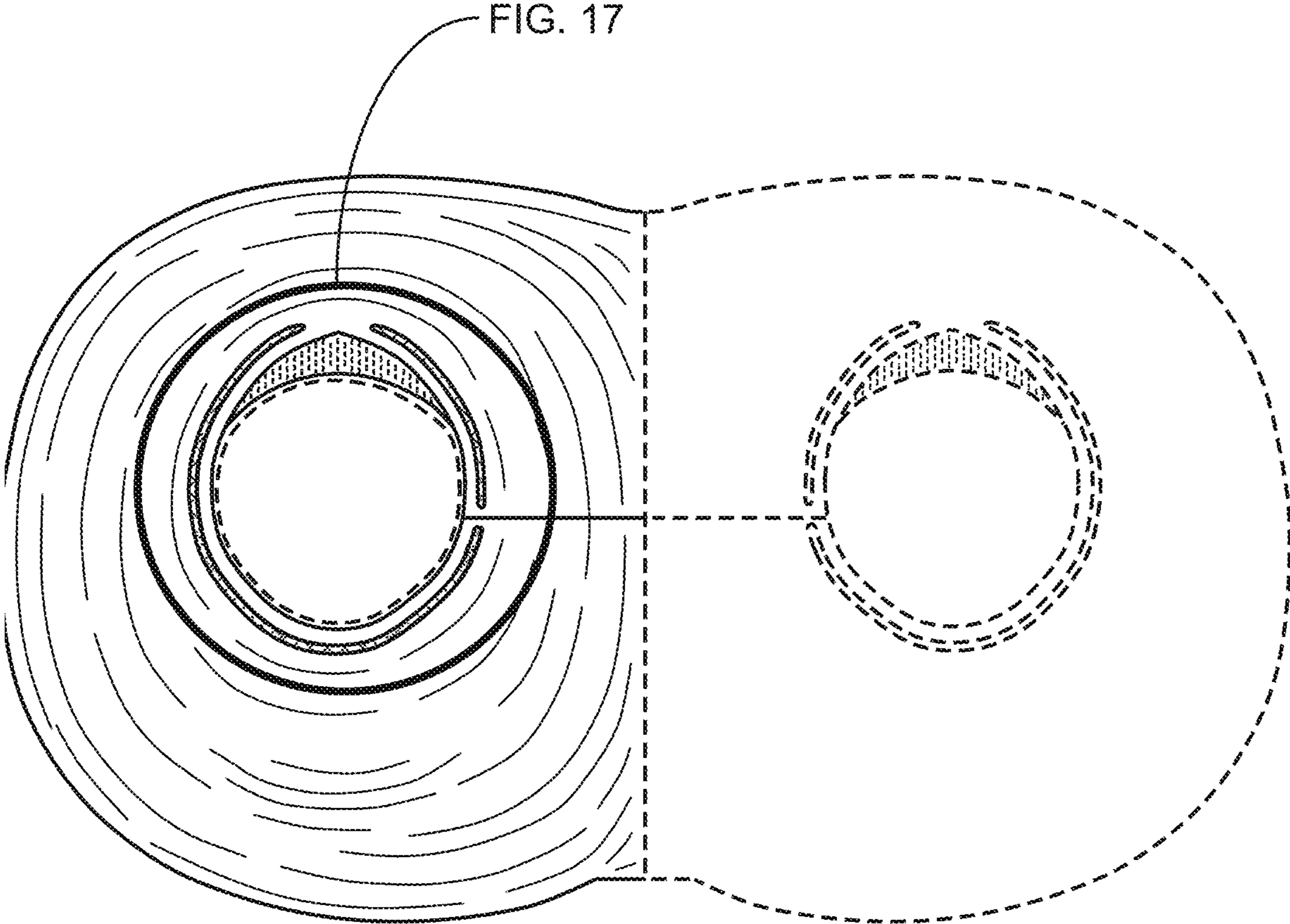

FIG. 16

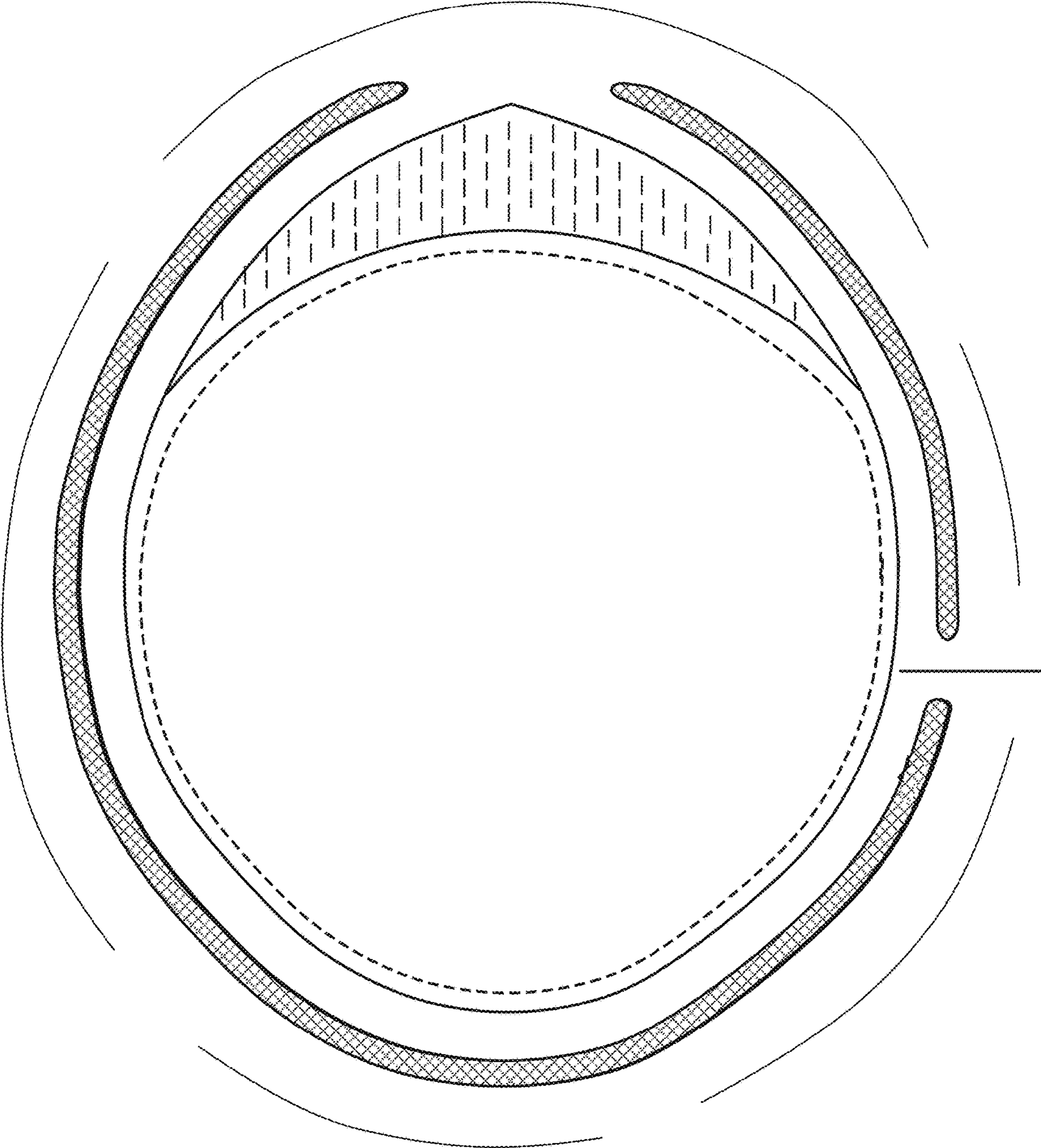

FIG. 17