



US00D882175S

(12) **United States Design Patent**  
**Riehle et al.**

(10) **Patent No.:** **US D882,175 S**  
(45) **Date of Patent:** **\*\* Apr. 21, 2020**

- (54) **RAZOR HANDLE**
- (71) Applicant: **The Gillette Company LLC**, Boston, MA (US)
- (72) Inventors: **Jonathon Albert Riehle**, Brighton, MA (US); **Jahdiel Fyfield**, Roslindale, MA (US)
- (73) Assignee: **The Gillette Company LLC**, Boston, MA (US)
- (\*\*) Term: **15 Years**
- (21) Appl. No.: **29/662,390**
- (22) Filed: **Sep. 5, 2018**
- (51) **LOC (12) Cl.** ..... **28-03**
- (52) **U.S. Cl.**  
USPC ..... **D28/48**
- (58) **Field of Classification Search**  
USPC ..... D28/46-48, 49-51; D7/395, 401.2  
CPC ... B26B 21/00; B26B 21/08; B26B 21/14-38;  
B26B 21/40; B26B 21/4006; B26B 21/4012-4031; B26B 21/4037; B26B 21/405-4056; B26B 21/4062; B26B 21/4068-4075; B26B 21/48; B26B 21/52-528  
See application file for complete search history.

8,448,339	B2 *	5/2013	Walker, Jr. ....	B26B 21/4031	30/50
D731,709	S *	6/2015	Provost .....	D28/48	
D739,604	S *	9/2015	Christie .....	D28/48	
D843,058	S *	3/2019	Fyfield .....	D28/46	
D843,060	S *	3/2019	Fyfield .....	D28/48	
D843,659	S *	3/2019	Go .....	D28/48	
2011/0203124	A1 *	8/2011	Bridges .....	B26B 21/4037	30/539

\* cited by examiner

*Primary Examiner* — Jennifer Rivard

(74) *Attorney, Agent, or Firm* — Joanne N. Pappas; Kevin C. Johnson

(57) **CLAIM**

The ornamental design for a razor handle, as shown and described.

**DESCRIPTION**

FIG. 1 is a front perspective view of a design of a razor handle of the present invention;  
 FIG. 2 is a front view thereof;  
 FIG. 3 is a back view thereof;  
 FIG. 4 is a right side view thereof;  
 FIG. 5 is a left side view thereof;  
 FIG. 6 is a top view thereof;  
 FIG. 7 is a bottom view thereof;  
 FIG. 8 is a rear perspective view thereof;  
 FIG. 9 is a front perspective view of a second embodiment of a razor handle of the present invention;  
 FIG. 10 is a front view thereof;  
 FIG. 11 is a back view thereof;  
 FIG. 12 is a right side view thereof;  
 FIG. 13 is a left side view thereof;  
 FIG. 14 is a top view thereof;  
 FIG. 15 is a bottom view thereof; and,  
 FIG. 16 is a rear perspective view thereof.  
 The broken lines illustrate portions of the razor handle that form no part of the claimed design.

(56) **References Cited**

U.S. PATENT DOCUMENTS

D550,401	S *	9/2007	Rhoad .....	D28/48
D602,634	S *	10/2009	Cataudella .....	D28/46
D603,098	S *	10/2009	Cataudella .....	D28/48
D613,456	S *	4/2010	Cataudella .....	D28/46
D630,797	S *	1/2011	Witkus .....	D28/47
D633,254	S *	2/2011	Witkus .....	D28/47
D658,809	S *	5/2012	Jessemeey .....	D28/47
8,186,062	B2 *	5/2012	Fischer .....	B26B 21/4018
				30/34.2
D665,948	S *	8/2012	Jessemeey .....	D28/47

**1 Claim, 10 Drawing Sheets**

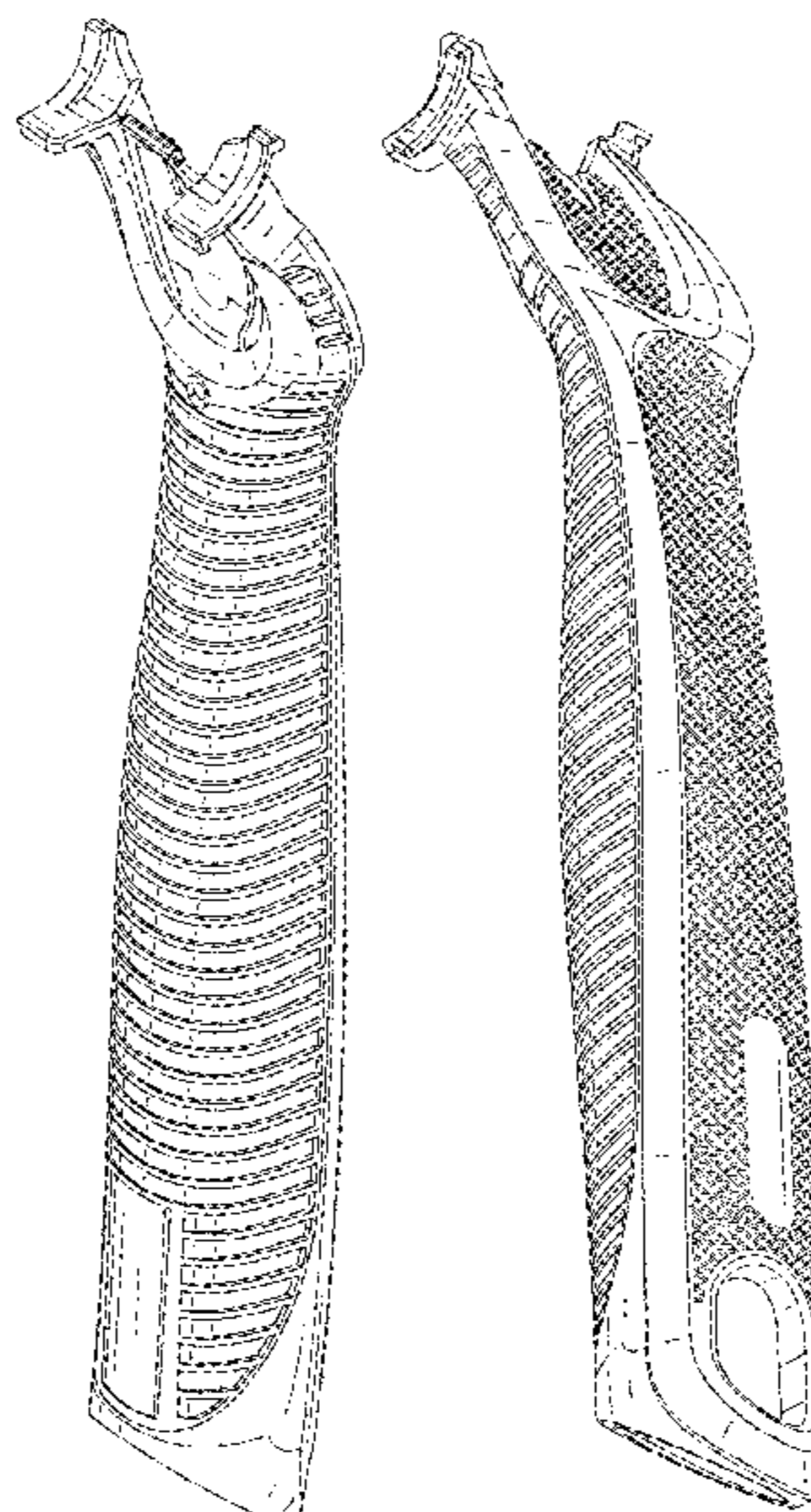

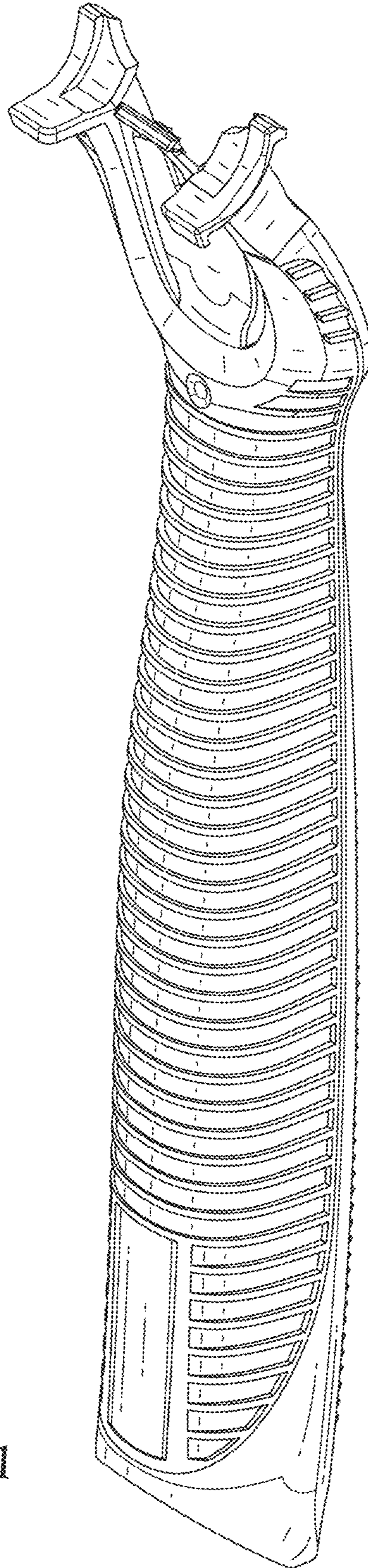

FIG. 1

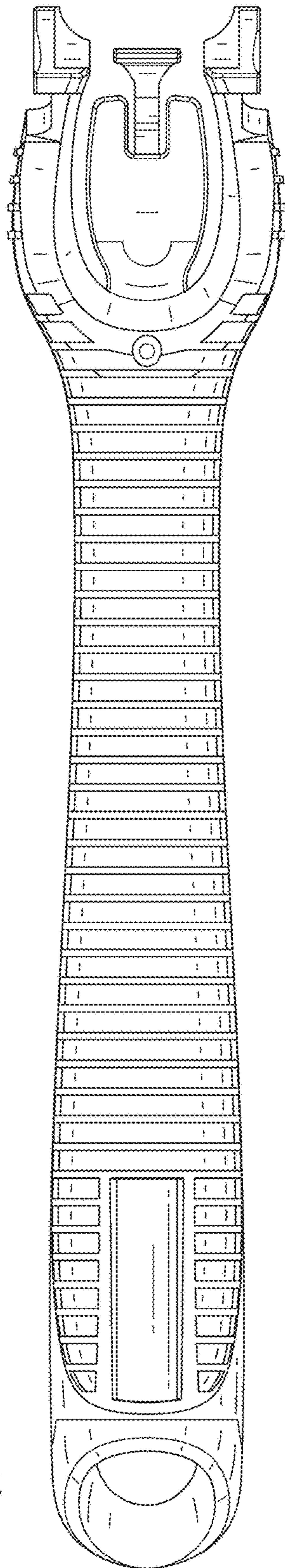

FIG. 2

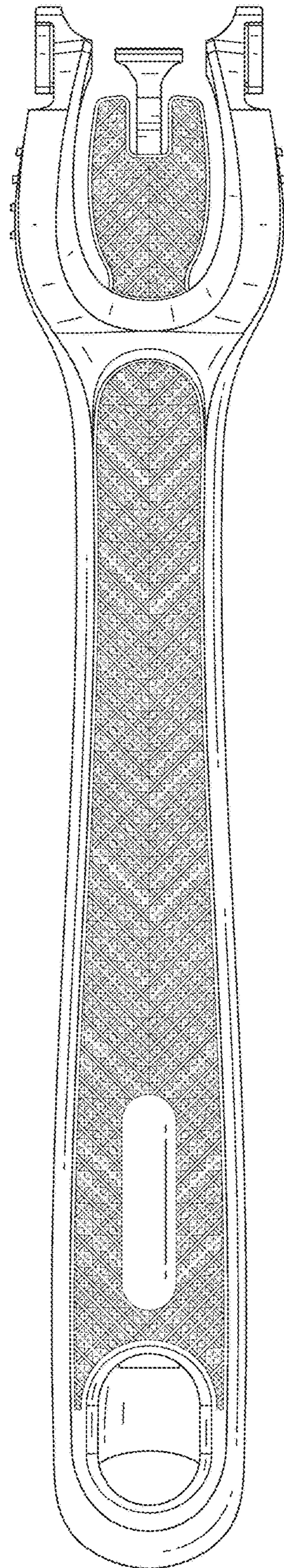

FIG. 3

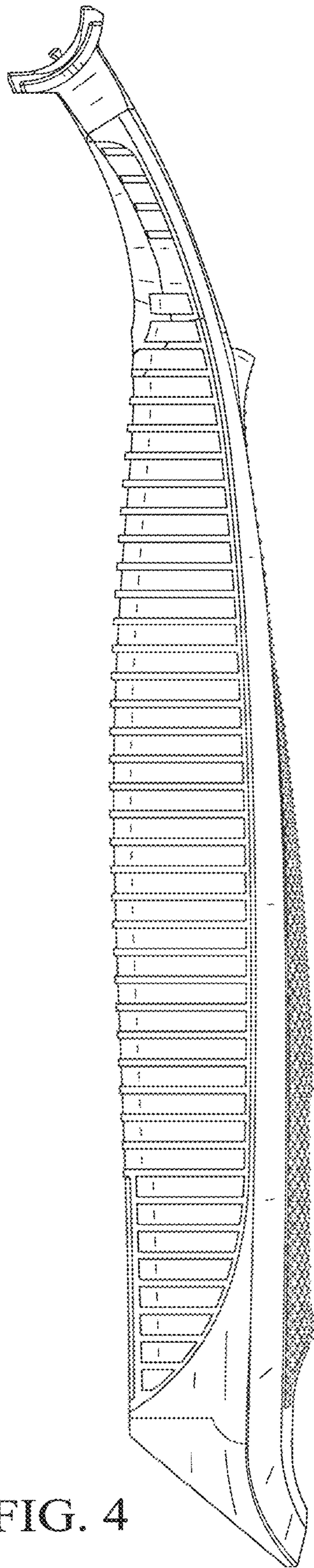

FIG. 4

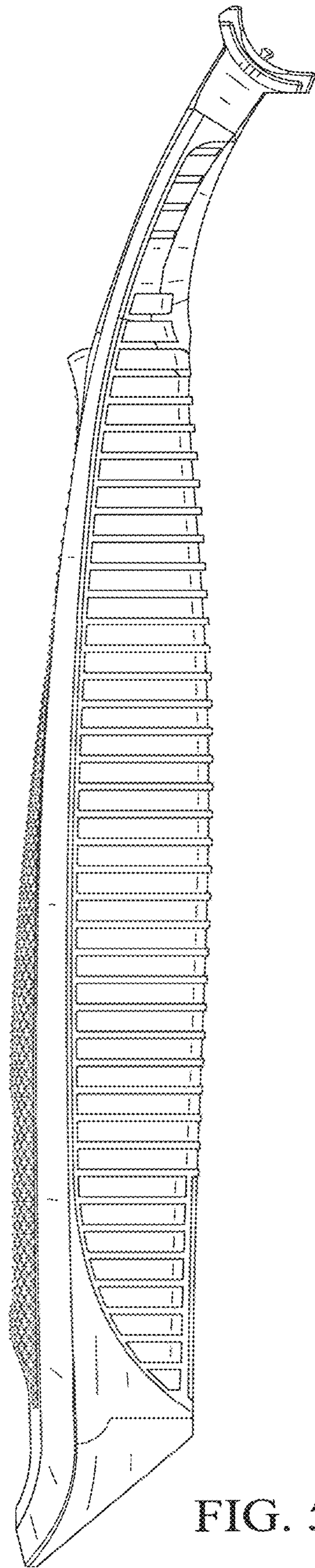

FIG. 5

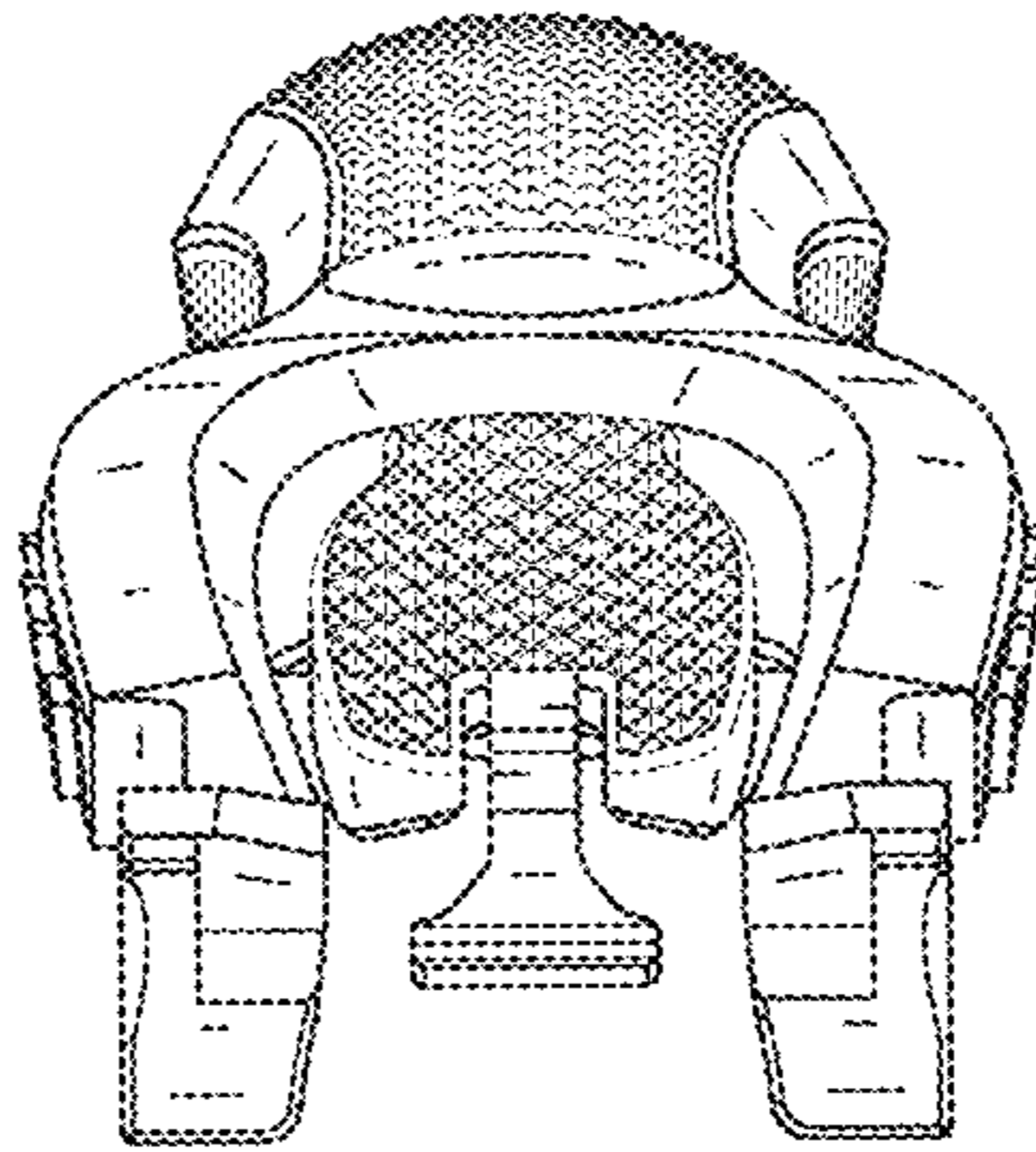

FIG. 6

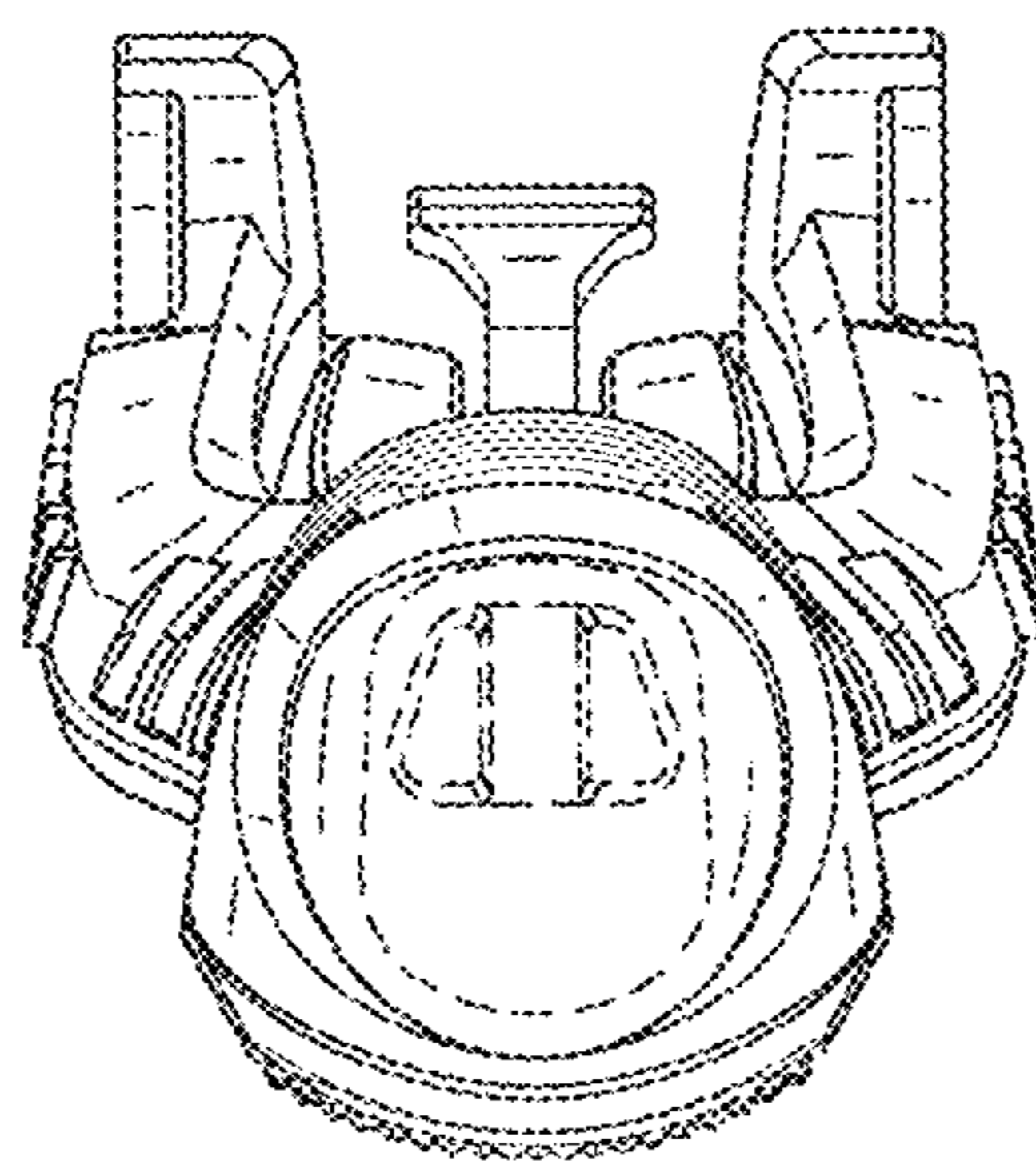

FIG. 7

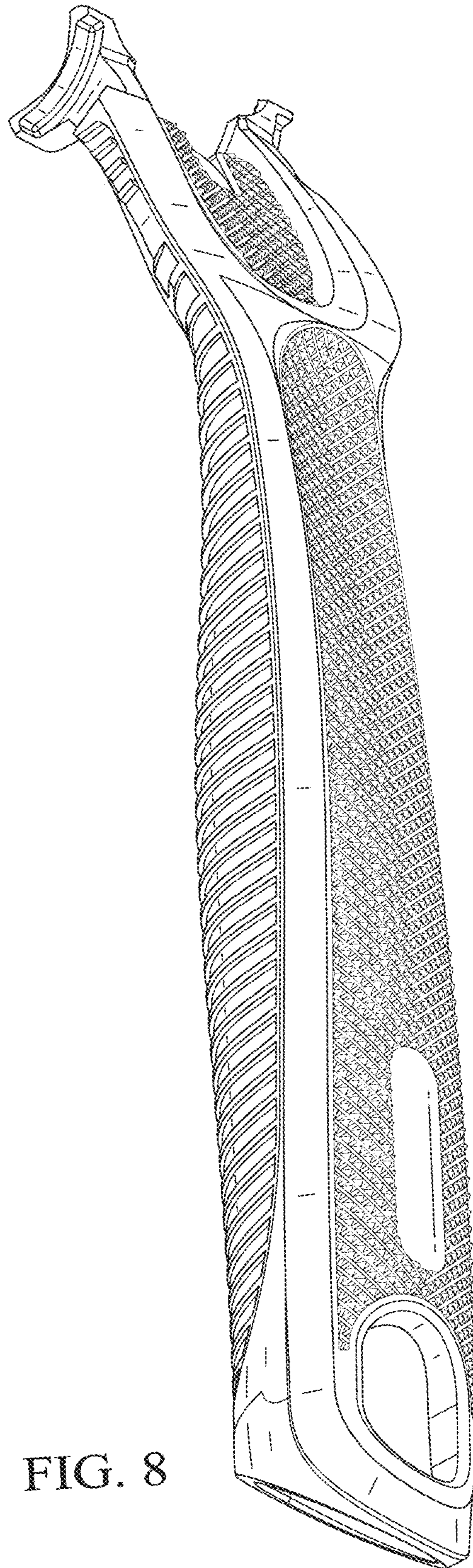

FIG. 8

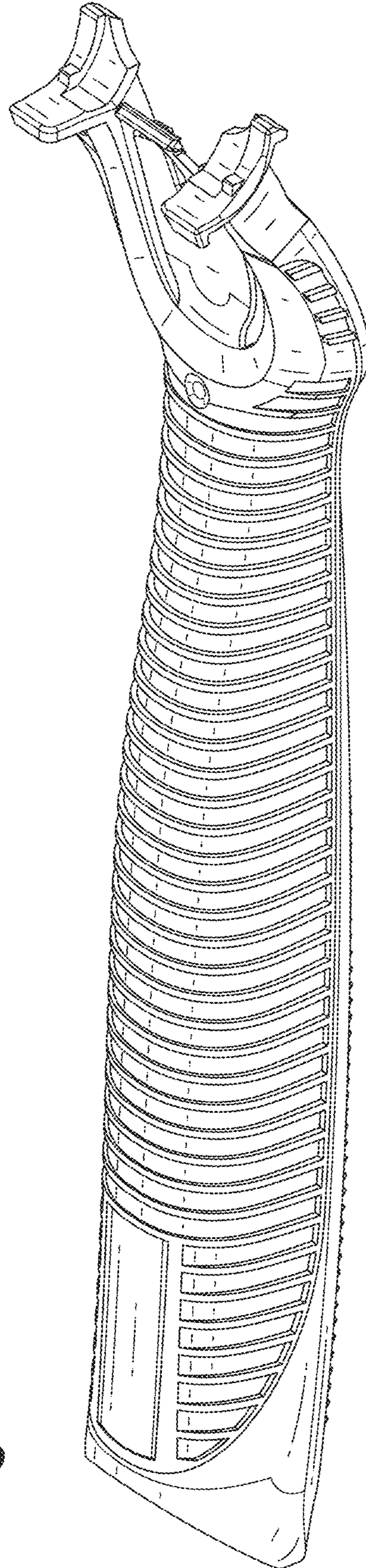

FIG. 9

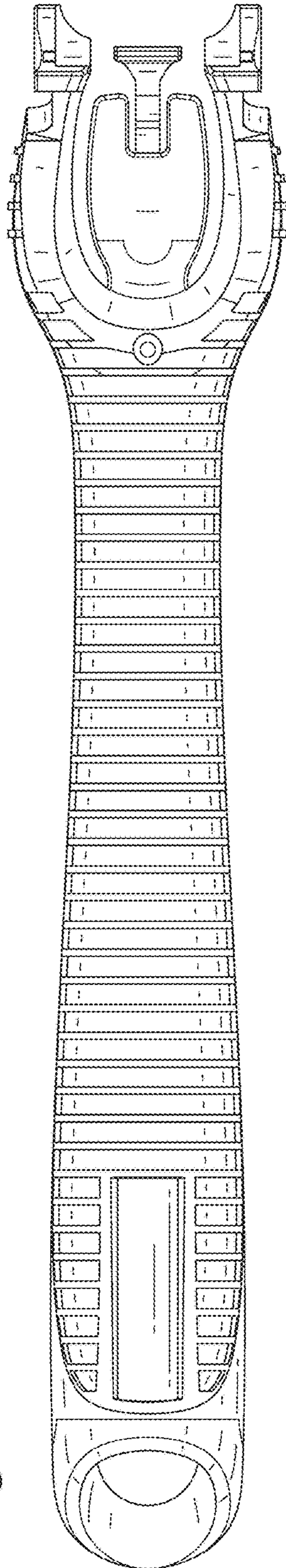

FIG. 10

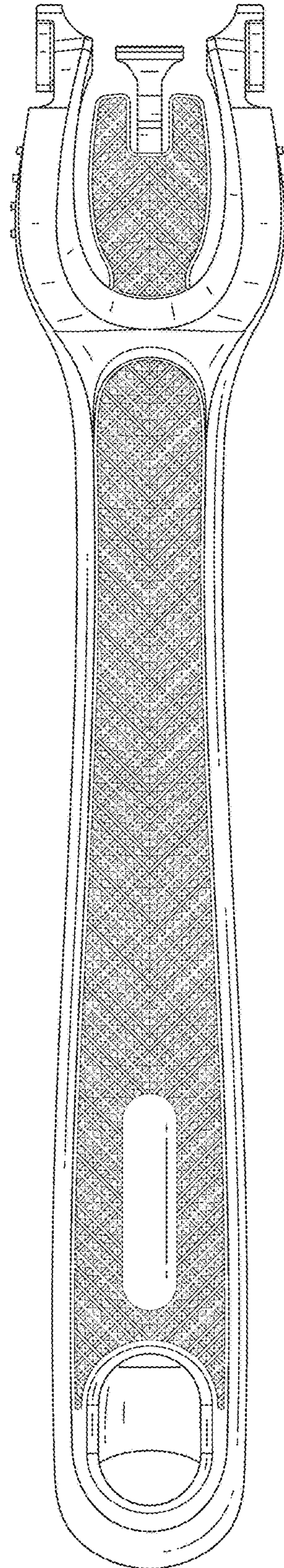

FIG. 11



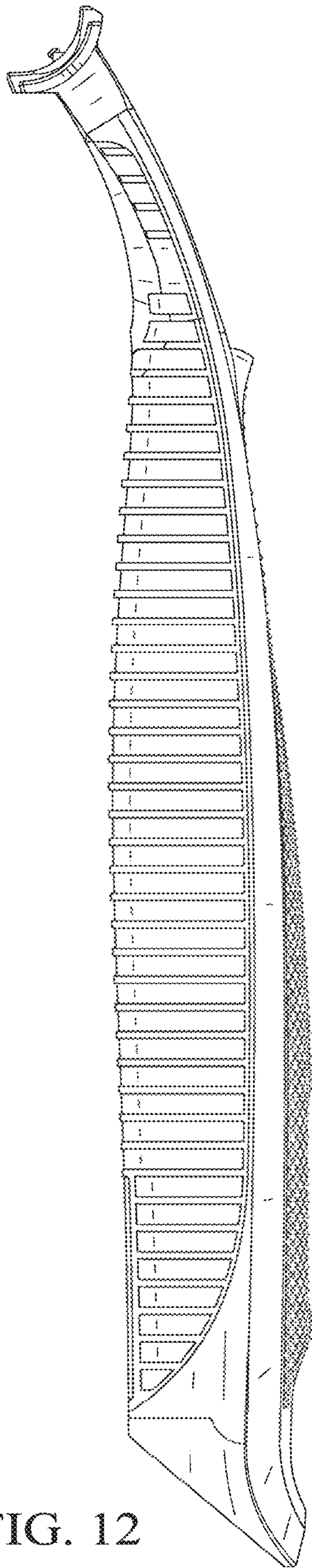

FIG. 12

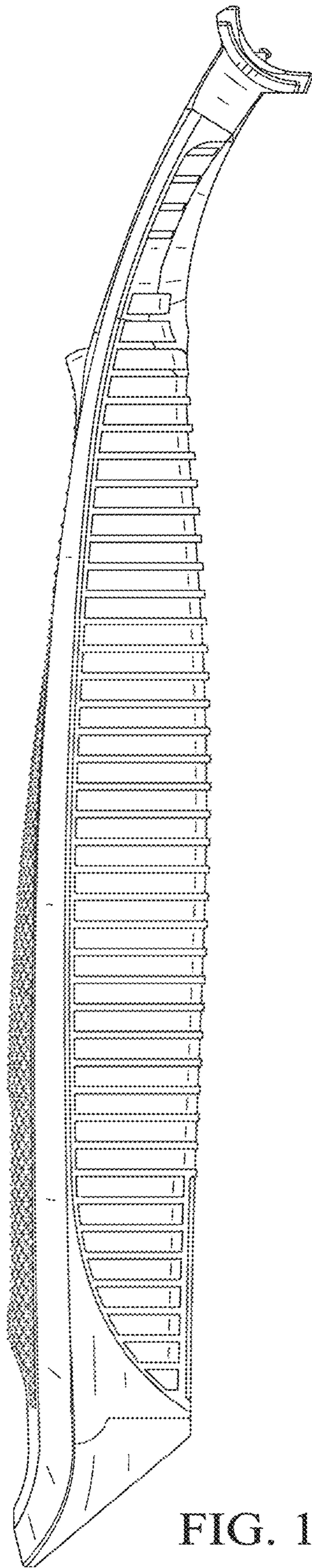

FIG. 13

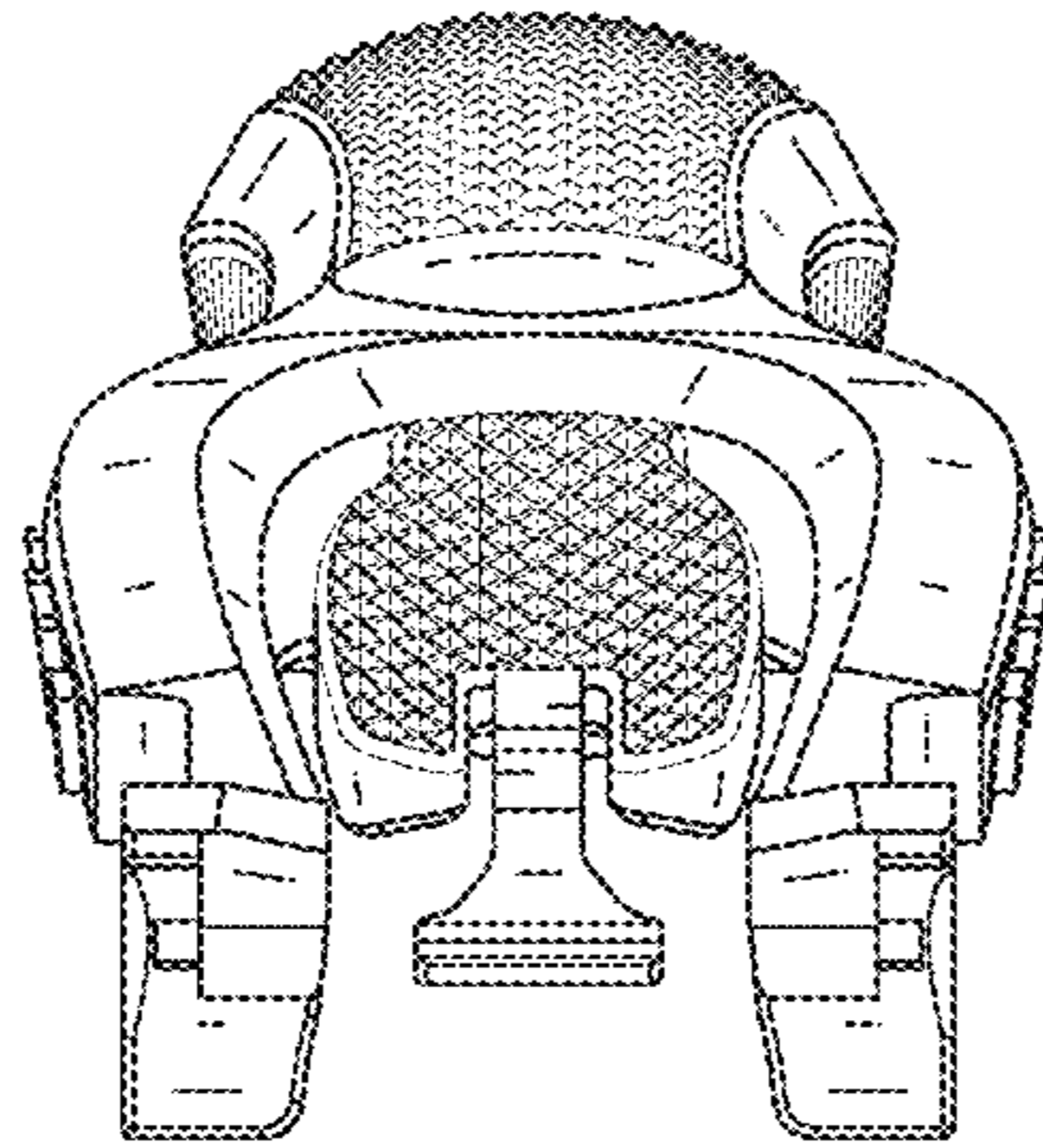

FIG. 14

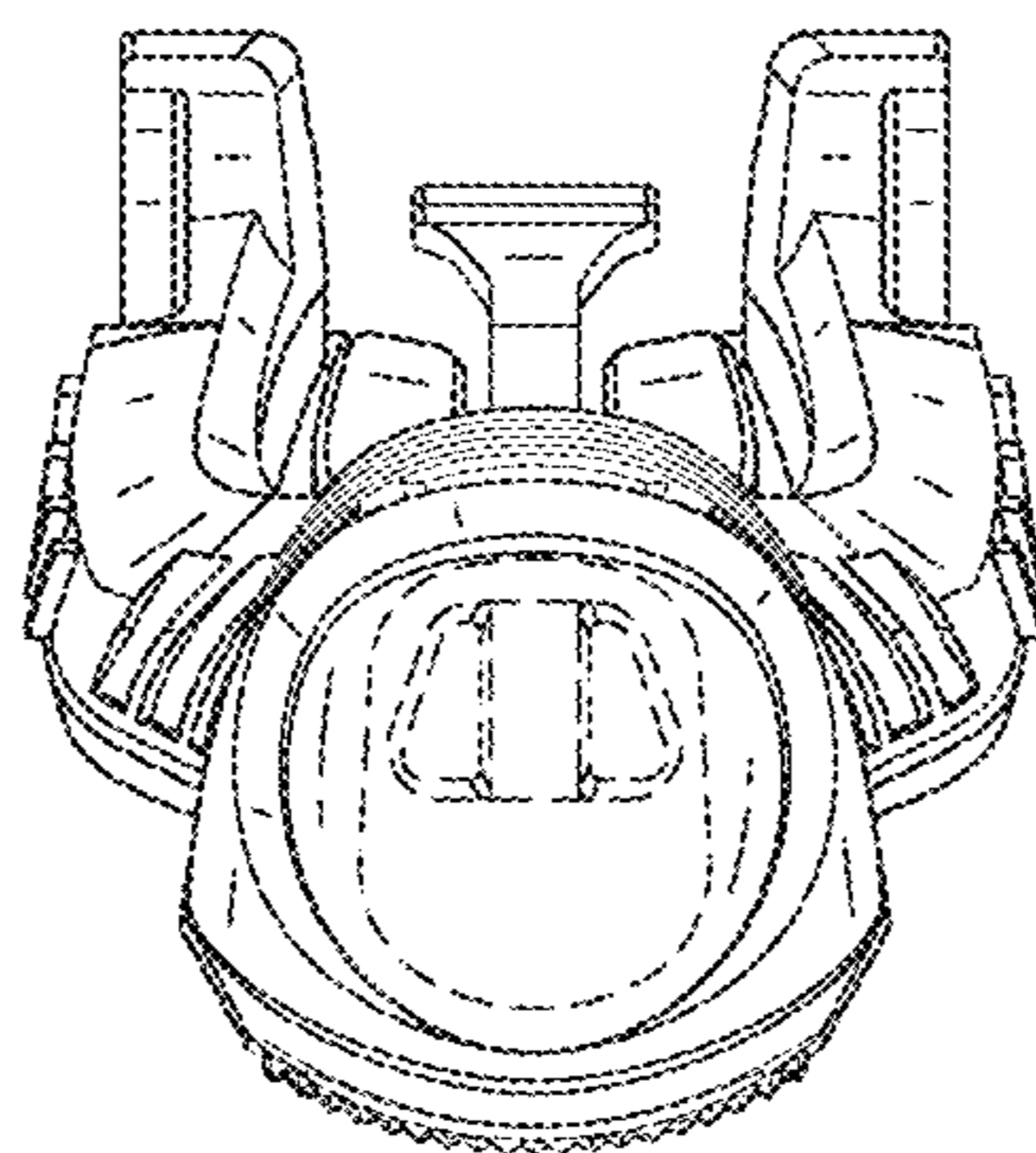

FIG. 15

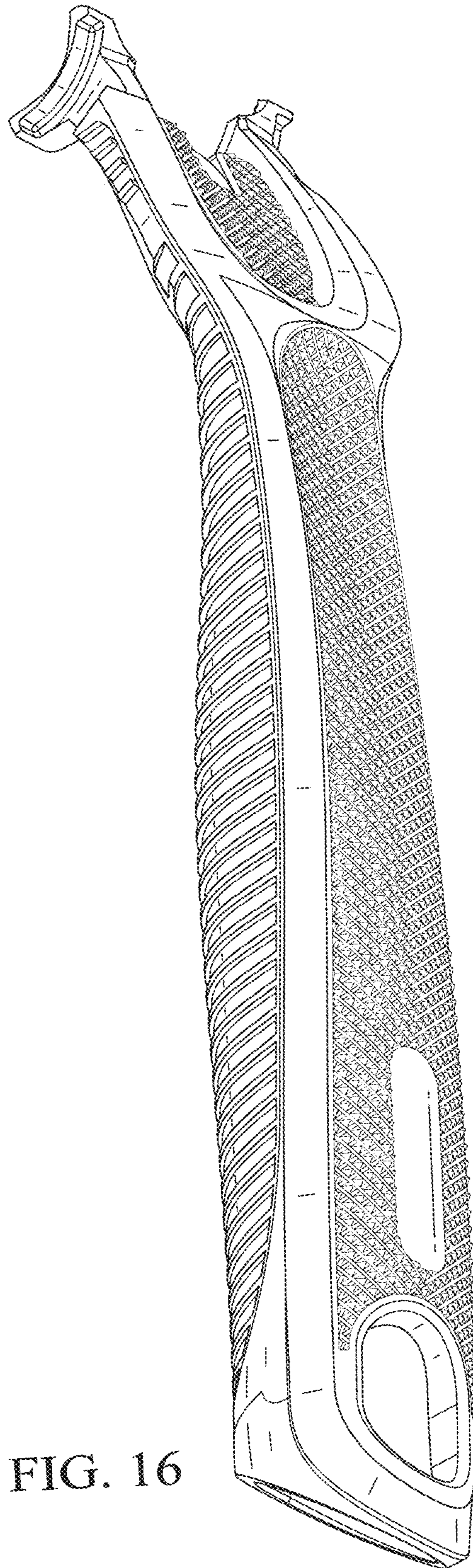

FIG. 16