



US00D882104S

(12) **United States Design Patent** (10) **Patent No.:** **US D882,104 S**  
**Sedic** (45) **Date of Patent:** **\*\* Apr. 21, 2020**

- (54) **SKIN MASSAGER**
- (71) Applicant: **Filip Sedic**, Stockholm (SE)
- (72) Inventor: **Filip Sedic**, Stockholm (SE)
- (73) Assignee: **FOREO Inc.**, Las Vegas, NV (US)
- (\*\*) Term: **15 Years**
- (21) Appl. No.: **29/678,094**
- (22) Filed: **Jan. 25, 2019**
- (51) **LOC (12) Cl.** ..... **28-03**
- (52) **U.S. Cl.**  
USPC ..... **D24/215**
- (58) **Field of Classification Search**  
USPC ..... 601/15, 18, 19, 27, 28, 29, 30, 31, 32,  
601/46, 47, 48, 52, 72, DIG. 12,  
601/DIG. 14–DIG. 17; D24/200, 211,  
D24/212, 213, 214, 215; D28/63;  
D30/160; D4/102  
CPC ..... A61H 1/00; A61H 2201/0153; A61H  
2201/169; A61H 7/002; A61H 7/00  
See application file for complete search history.

6,283,930	B1	9/2001	Purvis et al.
6,393,718	B1	5/2002	Harris et al.
6,432,072	B1	8/2002	Harris et al.
D466,217	S	11/2002	Harris et al.
D466,695	S	12/2002	Chen
D469,183	S	1/2003	Gerth et al.
D476,087	S	6/2003	Dirks et al.
6,588,964	B1	7/2003	Au et al.
D478,174	S	8/2003	Huang
D487,592	S	3/2004	Chang
D512,225	S	12/2005	Chien
D514,328	S	2/2006	Huang
D517,218	S	3/2006	Kalen
D523,561	S	6/2006	Telford
D539,917	S	4/2007	Park
D548,851	S	8/2007	Huang
D549,351	S	8/2007	Wu
7,303,534	B2	12/2007	Kahn
7,320,691	B2	1/2008	Pilcher et al.
D569,106	S	5/2008	Maruyama
D571,926	S	6/2008	Wu
7,384,377	B2	6/2008	Berman
D574,108	S	7/2008	Yando et al.
D576,736	S	9/2008	Hagege
D595,898	S	7/2009	Syran et al.
D616,103	S	5/2010	Ford-Robertson
D622,405	S	8/2010	Tuli
D626,656	S	11/2010	Jarry
D629,528	S	12/2010	Adkisson
D635,720	S	4/2011	Cammarano
D645,569	S	9/2011	Nitsch
D646,795	S	10/2011	Seehoff et al.
D671,281	S	11/2012	Singer
D674,108	S	1/2013	York
8,523,791	B2	9/2013	Castel
D698,455	S	1/2014	Sedic
8,679,039	B2	3/2014	Tieu et al.
8,745,807	B2	6/2014	Varner et al.
D715,935	S	10/2014	Huntington et al.
D716,961	S	11/2014	Sedic
D734,481	S	7/2015	Sedic
D764,172	S *	8/2016	Pan ..... D4/100
D769,455	S	10/2016	Sedic
D773,064	S	11/2016	Sedic
D804,189	S *	12/2017	von Berg ..... D4/100
D818,272	S *	5/2018	Tai ..... D4/100
D819,338	S *	6/2018	Xiong ..... D4/102
D822,387	S *	7/2018	Tai ..... D4/100
D823,606	S *	7/2018	Roth ..... D4/134
D825,124	S *	8/2018	Celia, Jr. .... D32/35
D837,994	S *	1/2019	Sedic ..... D24/214
D838,045	S *	1/2019	Miller ..... D28/63
D838,112	S *	1/2019	Yi ..... D4/120

(56) **References Cited**  
U.S. PATENT DOCUMENTS

1,491,016	A	4/1924	McGowan et al.
2,480,023	A	8/1949	Holden
2,764,773	A	10/1956	Glanvill et al.
3,906,940	A	9/1975	Kawada
3,968,789	A	7/1976	Simoncini
4,564,032	A	1/1986	Araki
4,570,616	A	2/1986	Kunz et al.
D331,466	S	12/1992	Doria
5,176,130	A	1/1993	Kim
D351,474	S	10/1994	Huang
D369,220	S	4/1996	Huang
5,511,270	A	4/1996	Eliachar et al.
D382,645	S	8/1997	Bergeron
5,792,080	A	8/1998	Ookawa et al.
D423,109	S	4/2000	Allende
6,202,242	B1	3/2001	Salmon et al.
6,226,811	B1	5/2001	Fagan
6,267,736	B1	7/2001	McCambridge et al.

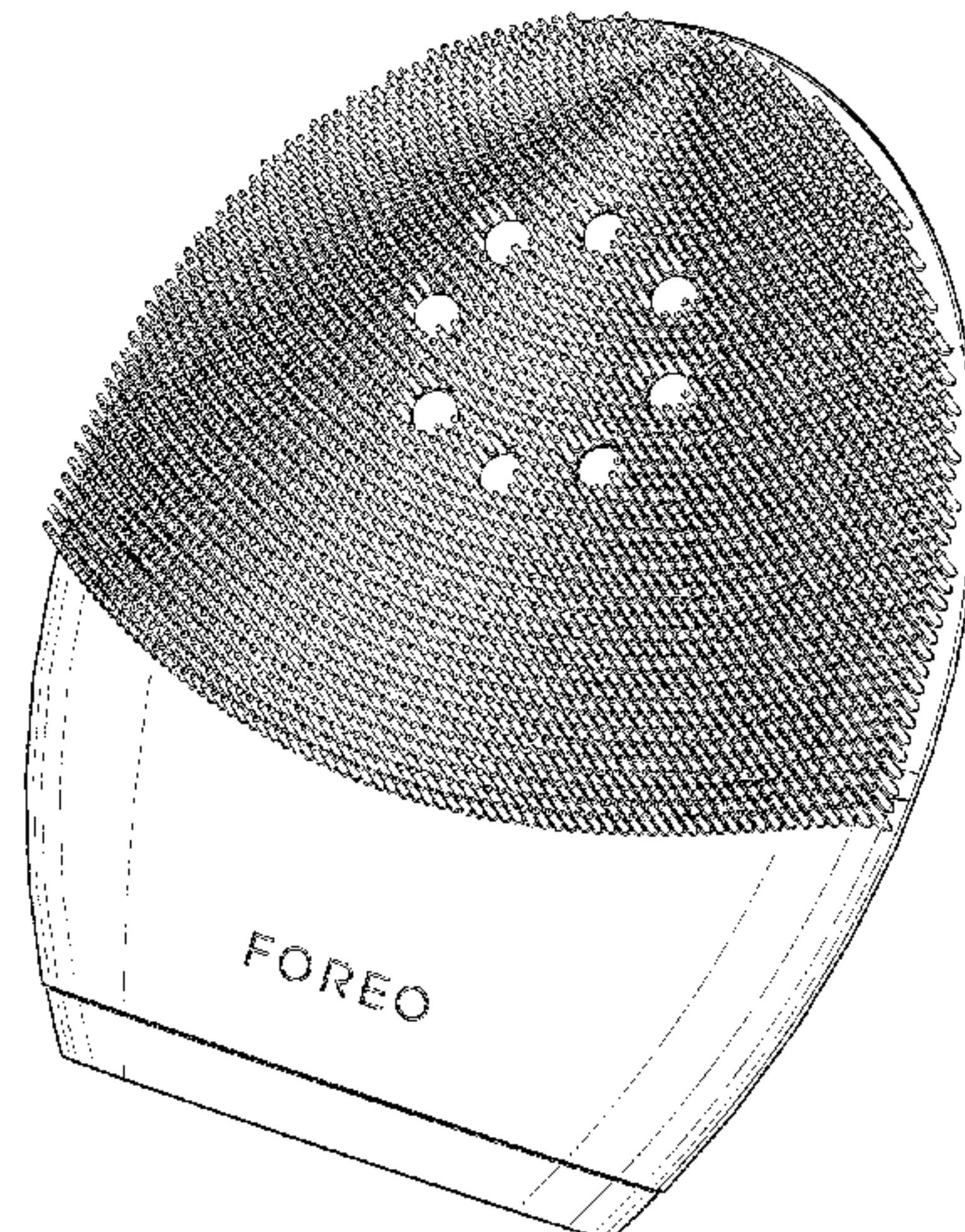



D845,630	S	*	4/2019	Sedic	.....	D4/100
D845,631	S	*	4/2019	Sedic	.....	D4/100
D849,263	S	*	5/2019	Soutelo Gomes	.....	D24/215
D850,111	S	*	6/2019	Sedic	.....	D4/100
D852,972	S	*	7/2019	Sedic	.....	D24/214
D857,221	S	*	8/2019	Sedic	.....	D24/215
D857,299	S	*	8/2019	Tammabattula	.....	D28/63
D862,891	S	*	10/2019	Sedic	.....	D4/100
D863,586	S	*	10/2019	Miller	.....	D24/214
D864,860	S	*	10/2019	Zhan	.....	D13/108
D866,074	S	*	11/2019	Tammabattula	.....	D28/63
D866,075	S	*	11/2019	Tammabattula	.....	D28/63
2002/0107459	A1		8/2002	Chang		
2004/0060571	A1		11/2004	Mayeri		
2004/0225239	A1		11/2004	Yamamoto et al.		
2005/0142093	A1		1/2005	Skover et al.		
2005/0059914	A1		5/2005	Kleinhenz et al.		
2005/0113725	A1		6/2005	Masuda		
2006/0010630	A1		3/2006	Tse		
2006/0058714	A1		8/2006	Rhoades		
2006/0168746	A1		12/2006	Guyuron et al.		
2006/0276731	A1		12/2006	Thiebaut et al.		
2007/0017540	A1		1/2007	Davis et al.		
2007/0142845	A1		6/2007	Akridge et al.		
2007/0179412	A1		8/2007	Imboden et al.		
2007/0198031	A1		8/2007	Kellogg		
2007/0232967	A1		10/2007	Driscoll		
2008/0110471	A1		5/2008	Oliver et al.		
2008/0119913	A1		5/2008	Powell et al.		
2008/0125680	A1		5/2008	Richmond et al.		
2008/0125682	A1		5/2008	Bonneyrat		
2008/0167590	A1		7/2008	Jon et al.		
2008/0210252	A1		9/2008	Taggart et al.		
2009/0036809	A1		2/2009	Nishio et al.		
2009/0198159	A1		8/2009	Linzell		
2009/0318853	A1		12/2009	Reed et al.		
2010/0217357	A1		8/2010	Da Silva et al.		
2010/0262051	A1		10/2010	De LaForcade		
2011/0087141	A1		4/2011	Wagy et al.		
2011/0098613	A1		4/2011	Thomas et al.		
2011/0184499	A1		7/2011	Radi		
2011/0251537	A1		10/2011	Yeo		
2012/0121313	A1		5/2012	Thiebaut		
2012/0165708	A1		6/2012	Parsloe		
2012/0209151	A1		8/2012	Zhou et al.		
2012/0234336	A1		9/2012	Paquet et al.		
2013/0023805	A1		1/2013	Ungemach et al.		
2013/0046212	A1		2/2013	Nichols		
2013/0079689	A1		3/2013	Thierman		
2014/0107543	A1		4/2014	Pazouki		
2014/0194900	A1		7/2014	Sedic		
2015/0105802	A1		4/2015	Sedic		
2019/0117497	A1*		4/2019	Sedic	.....	A61H 23/0218
2019/0142691	A1*		5/2019	Sedic	.....	A45D 44/002 601/18
2019/0290076	A1*		9/2019	Sedic	.....	A61H 7/003

FOREIGN PATENT DOCUMENTS

EP	1484043	12/2004
EP	1525872	4/2005
EP	1942857	7/2008
EP	2164443	3/2010
EP	2490645	8/2012
JP	2000-000283	1/2000
JP	2004-249061	9/2004
KR	101078567	1/2011

OTHER PUBLICATIONS

“Silicone Face Massage Brush,” Alibaba.com, 1999-2014, Alibaba.com, 6 pages [Online] [Retrieved on Sep. 15, 2014] Retrieved from the Internet<URL:http://www.alibaba.com/countrysearch/CN/silicone-face-massage-brush.html.

Silicone Suction Cup Face Exfoliate Beauty Brushes, SourcingMap Ltd., 2006-2014, two pages, [Online] [Retrieved on Sep. 15, 2014] Retrieved from the Internet<URL: http://www.sourcingmap.com/

ladies-silicone-suction-cup-face-exfoliate-beauty-brushes-pink-p-242745.html>.

“Clarisonic” Web Page, Clarisonic, Pacific Bioscience Laboratories, Inc., 2013, 2 pages, [Online] [Retrieved on Sep. 15, 2014] Retrieved from the Internet<URL: http://www.clarisonic.com/>.

“Neutrogena® Wave®,” Neutrogena Corporation, 2014, 1 page, [Online] [Retrieved on Sep. 15, 2014] Retrieved from the Internet<URL:http://www.neutrogenawave.com/#/products>.

“Silicon Face Brushes,” Alibaba.com, 1999-2014, Alibaba.com, 8 pages [Online] [Retrieved on Sep. 15, 2014] Retrieved from the Internet<URL:http://www.alibaba.com/manufacturers/face-silicone-brush-manufacturer.html>.

“Vibrating cosmetics,” 12 pages, PoshGlam®, Sep. 8, 2014, [Online] [Retrieved on Sep. 15, 2014] Retrieved from the Internet<URL:http://www.poshglam.com/beauty/>.

“Waterproof Electric Face Massager,” Alibaba.com, 1999-2014, 3 pages, [Online] [Retrieved on Sep. 15, 2014] Retrieved from the Internet<URL:http://www.alibaba.com/product-gs/537532136/Waterproof\_Electric\_Face\_Massager.html>.

“Skincare,” www.foreo.com, FOREO, accessed Jan. 20, 2019, pp. 1-13.

\* cited by examiner

Primary Examiner — Cynthia Ramirez  
 Assistant Examiner — Michael A Maharajh  
 (74) Attorney, Agent, or Firm — Evan Feldstein

(57) CLAIM

I claim the ornamental design for a skin massager, as shown and described.

DESCRIPTION

FIG. 1 is a perspective view of a first embodiment of a skin massager.

FIG. 2 is a front view of the first embodiment of the skin massager.

FIG. 3 is a rear view of the first embodiment of the skin massager.

FIG. 4 is a right side view of the first: embodiment of the skin massager.

FIG. 5 is a left side view of the first embodiment of the skin massager.

FIG. 6 is a top view of the first embodiment of the skin massager.

FIG. 7 is a bottom view of the first embodiment of the skin massager.

FIG. 8 is a perspective view of a second embodiment of a skin massager.

FIG. 9 is a front view of the second embodiment of the skin massager.

FIG. 10 is a rear view of the second embodiment of the skin massager.

FIG. 11 is a right side view of the second embodiment of the skin massager.

FIG. 12 is a left side view of the second embodiment of the skin massage.

FIG. 13 is a top view of the second embodiment of the skin massager.

FIG. 14 is a bottom view of the second embodiment of the skin massager.

FIG. 15 is a perspective view of a third embodiment of a skin massager.

FIG. 16 is a front view of the third embodiment of the skin massager.

FIG. 17 is a rear view of the third embodiment of the skin massager.

FIG. 18 is a right side view of the third embodiment of the skin massager.

FIG. 19 is a left side view of the third embodiment of the skin massager.

FIG. 20 is a top view of the third embodiment of the skin massager.

FIG. 21 is a bottom view of the third embodiment of the skin massager.

FIG. 22 is a perspective view of a fourth embodiment of a skin massager.

FIG. 23 is a front view of the fourth embodiment of the skin massager.

FIG. 24 is a rear view of the fourth embodiment of the skin massager.

FIG. 25 is a right side view of the fourth embodiment of the skin massager.

FIG. 26 is a left side view of the fourth embodiment of the skin massager.

FIG. 27 is a top view of the fourth embodiment of the skin massager; and,

FIG. 28 is a bottom view of the fourth embodiment of the skin massager.

The broken lines shown in the figures are for the purposes of illustrating portions of the skin massager, which form no part of the claimed design.

**1 Claim, 28 Drawing Sheets**



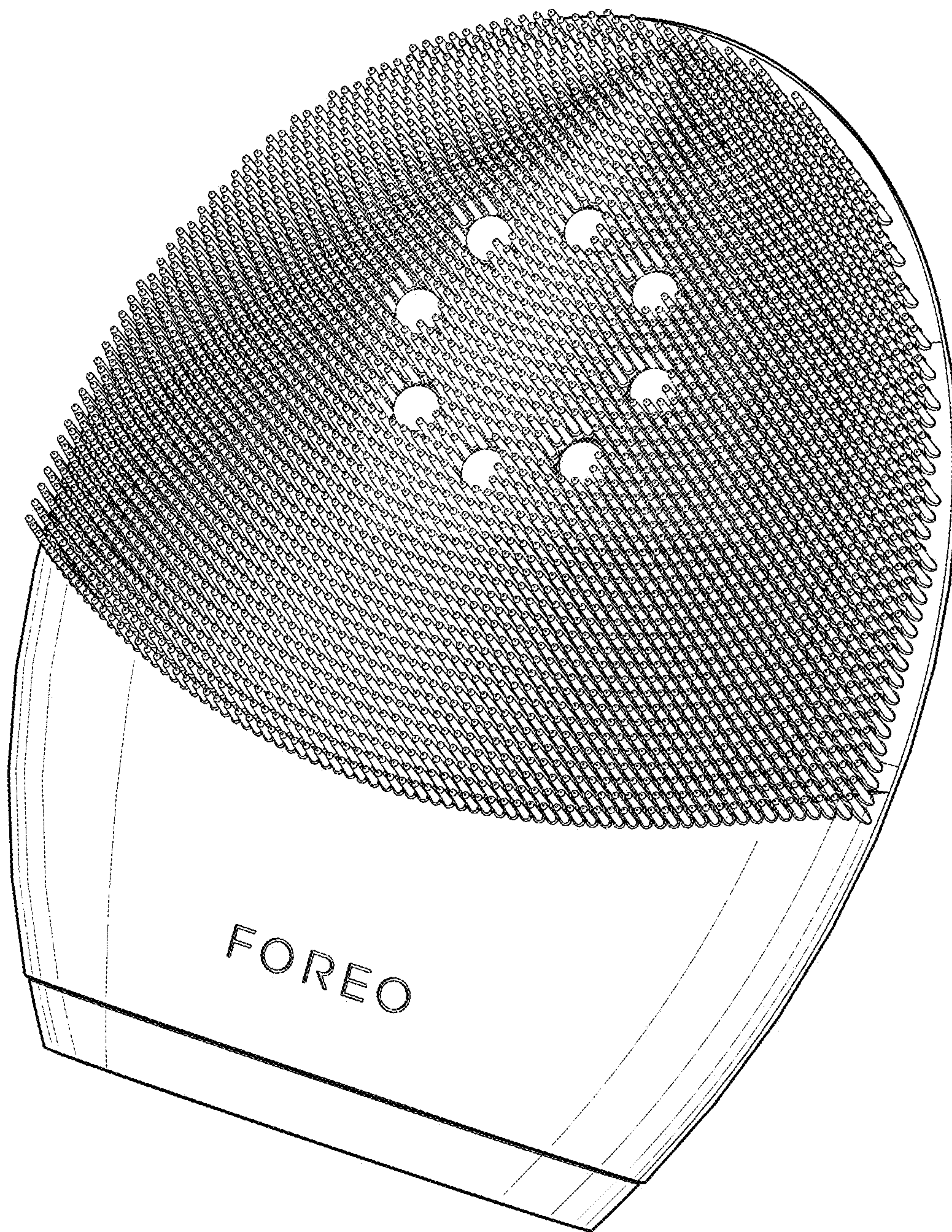

FIG. 1



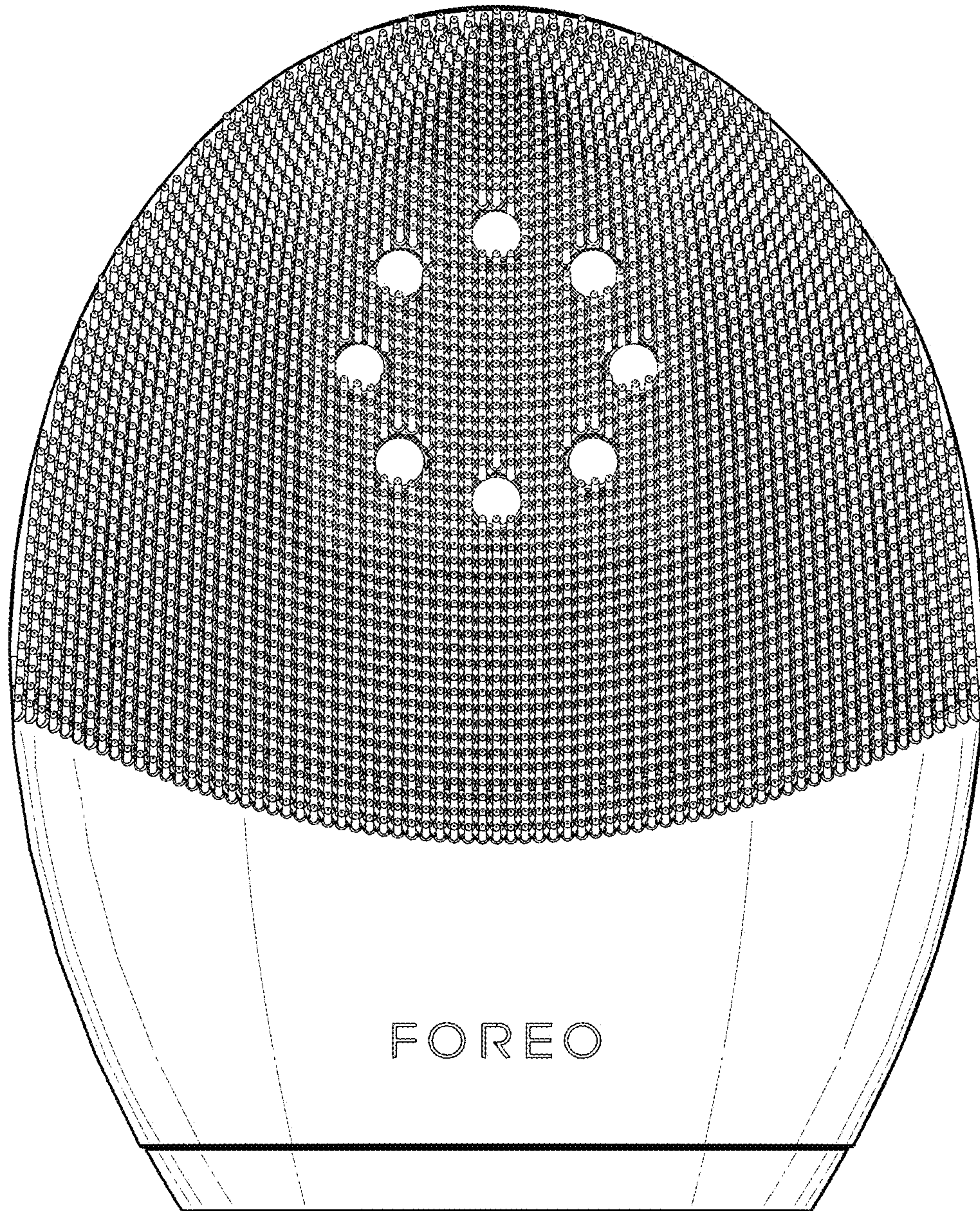

FIG. 2



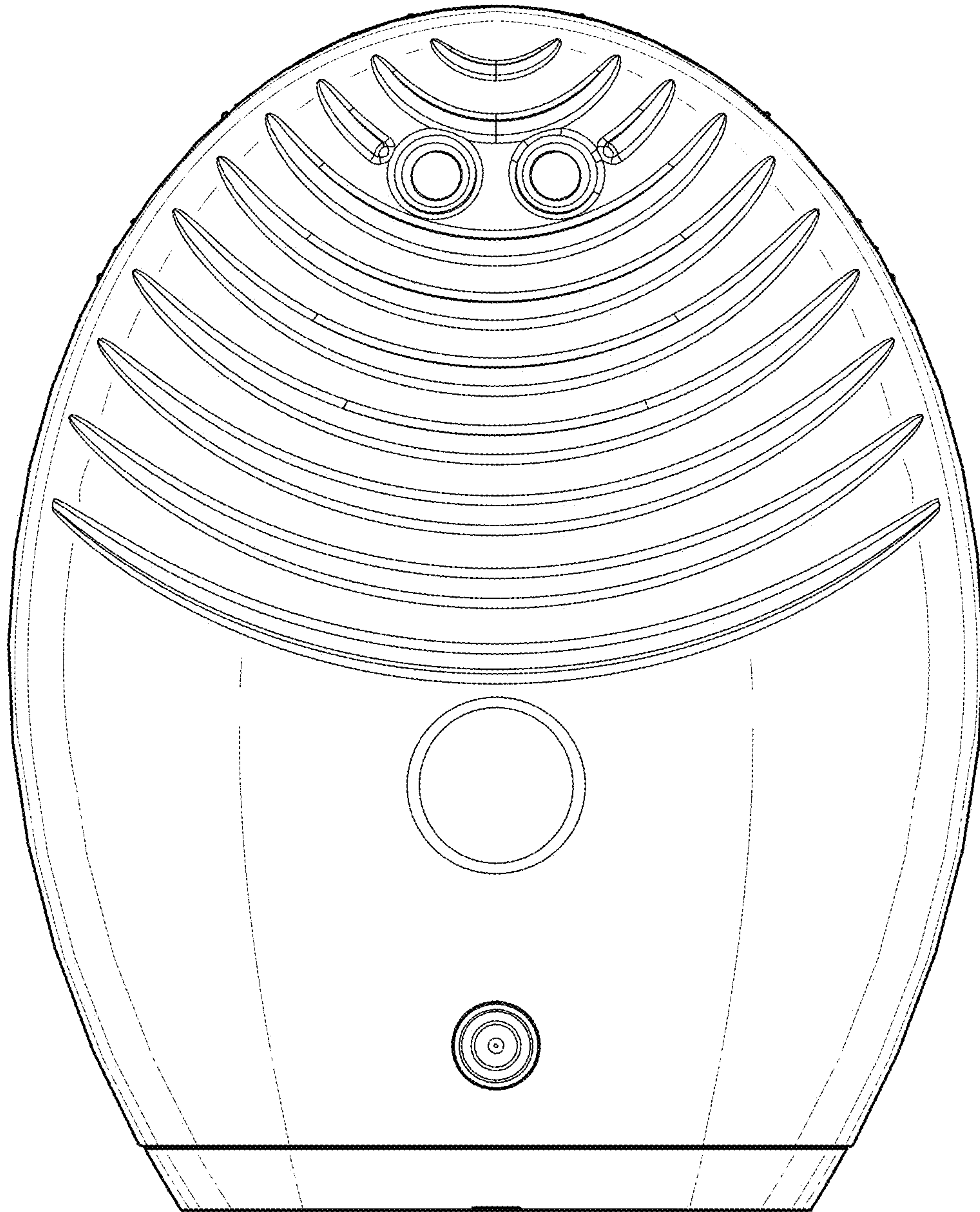

FIG. 3

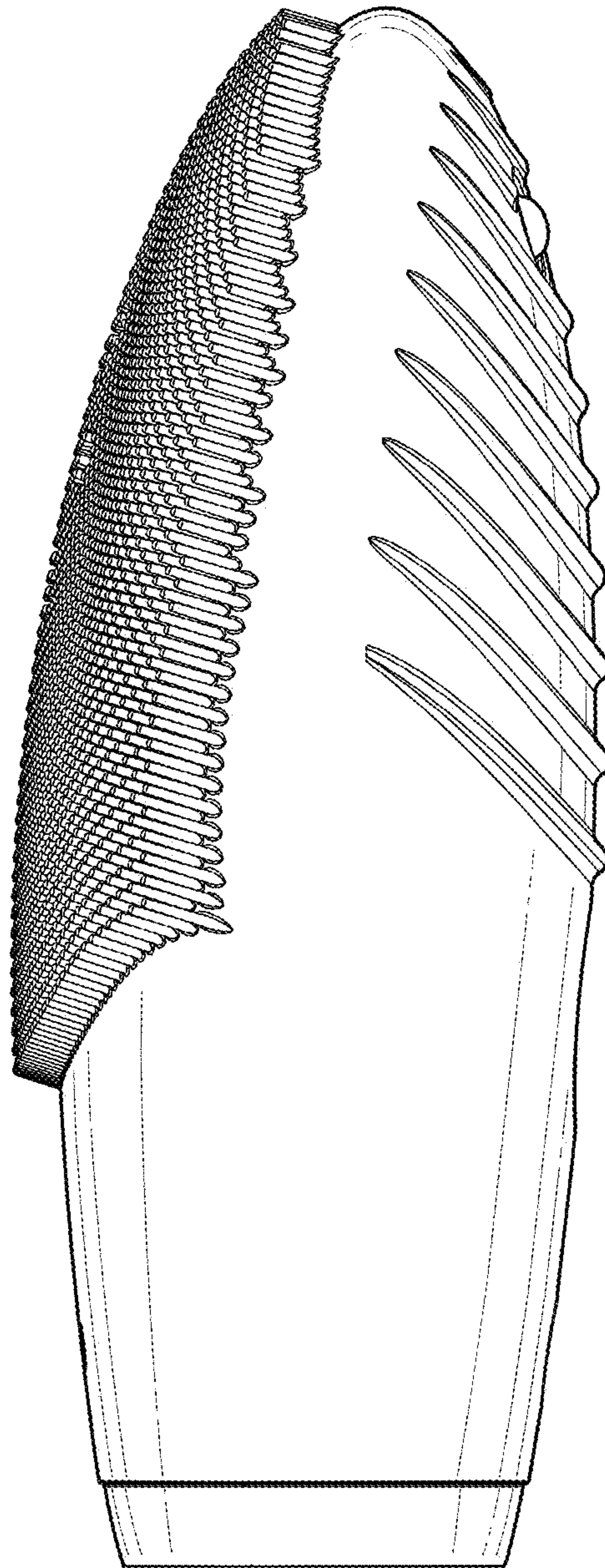

FIG. 4

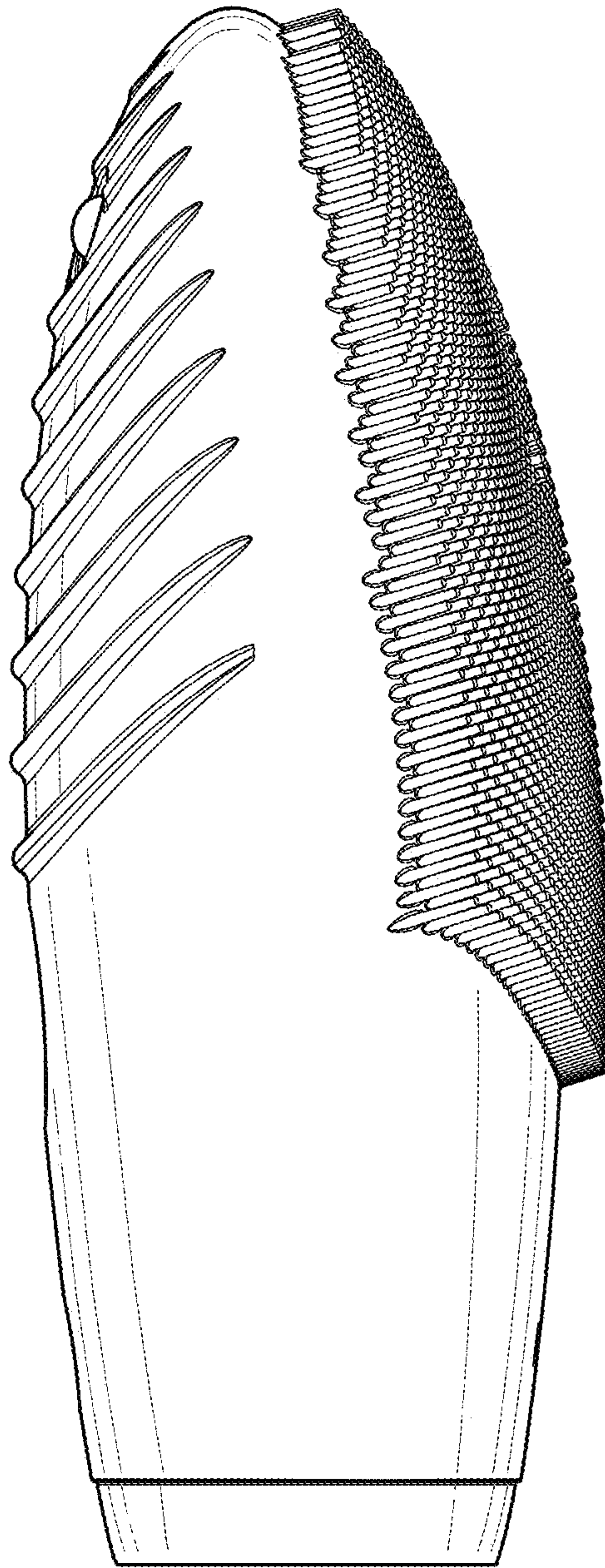

FIG. 5



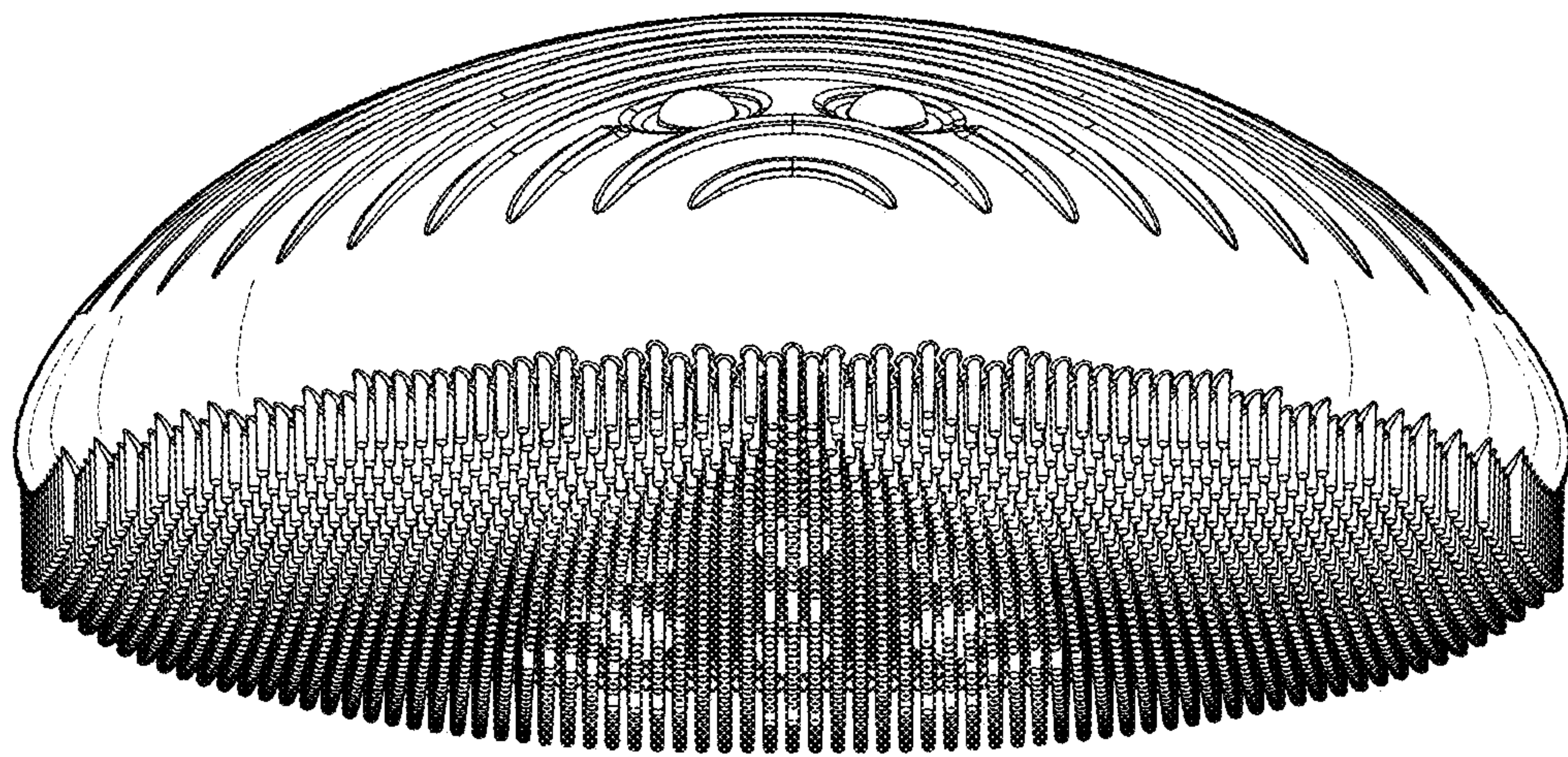

FIG. 6



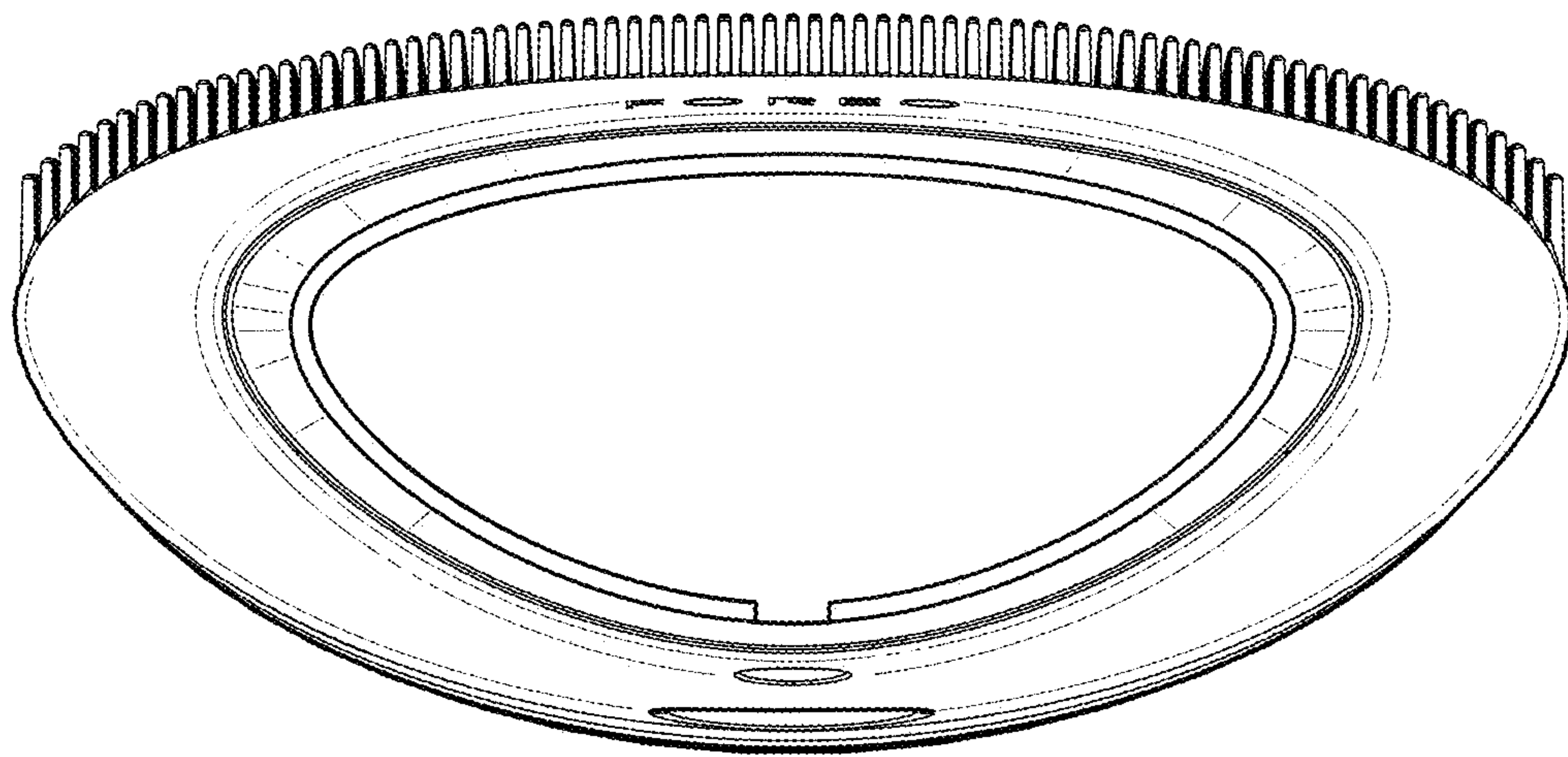

FIG. 7



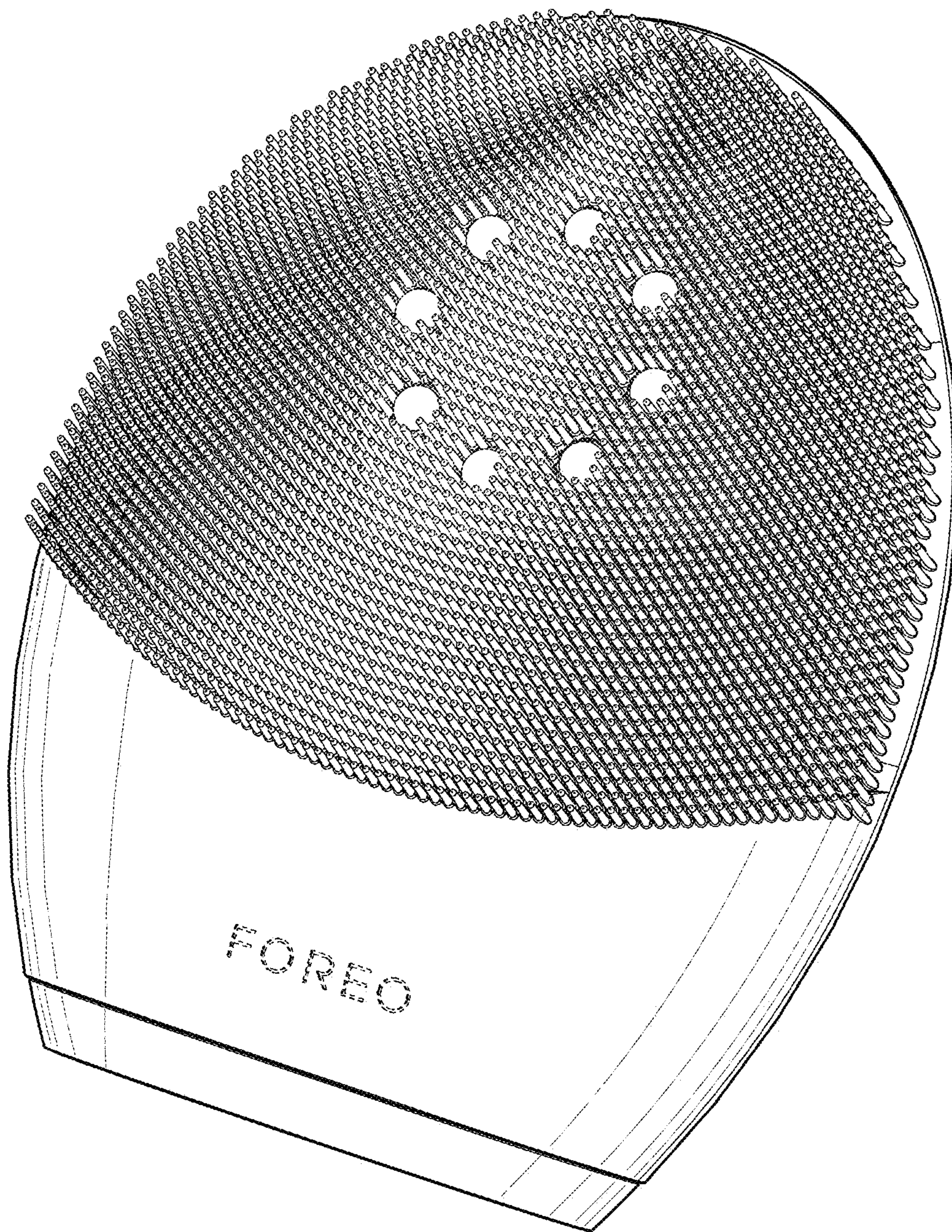

FIG. 8



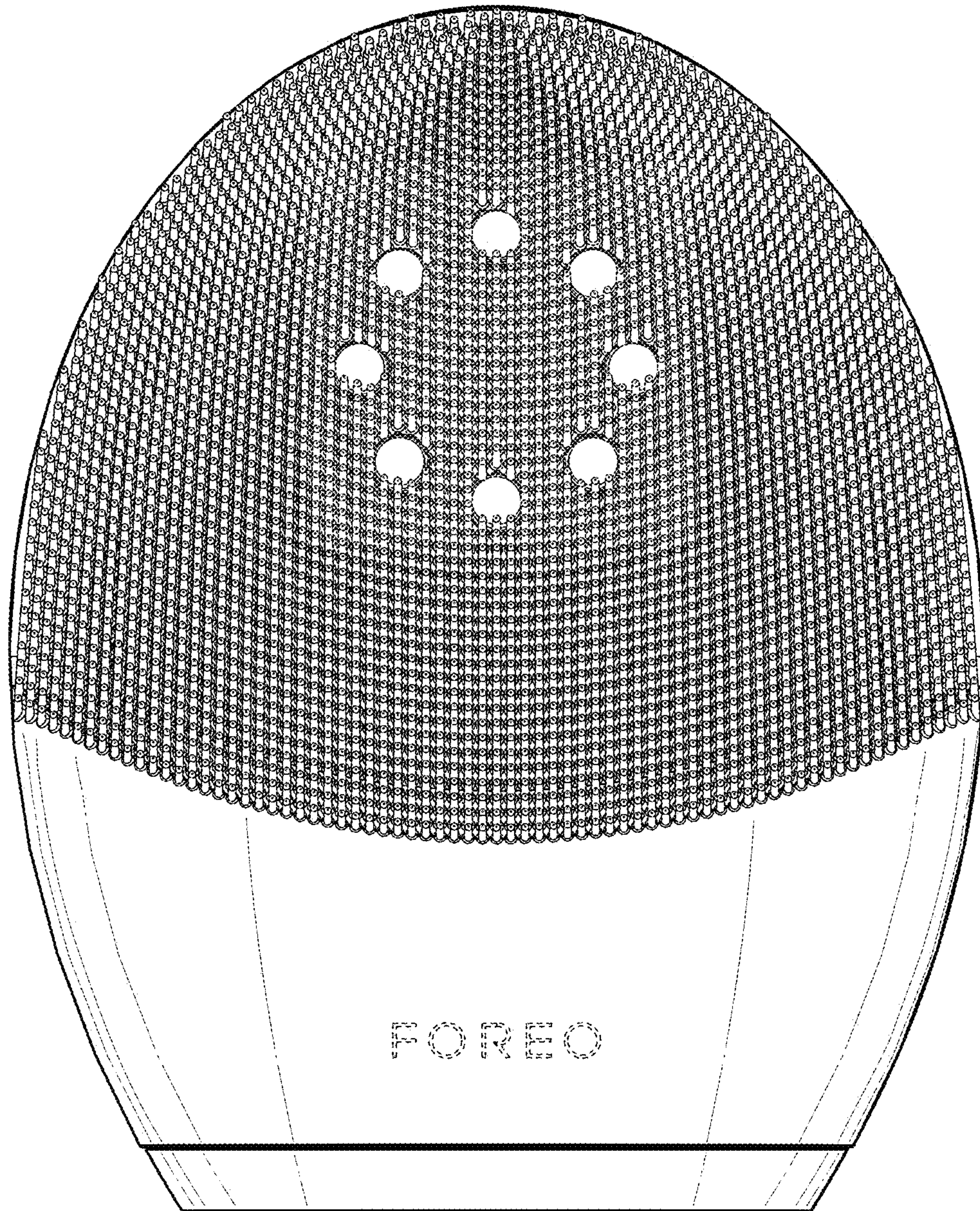

FIG. 9



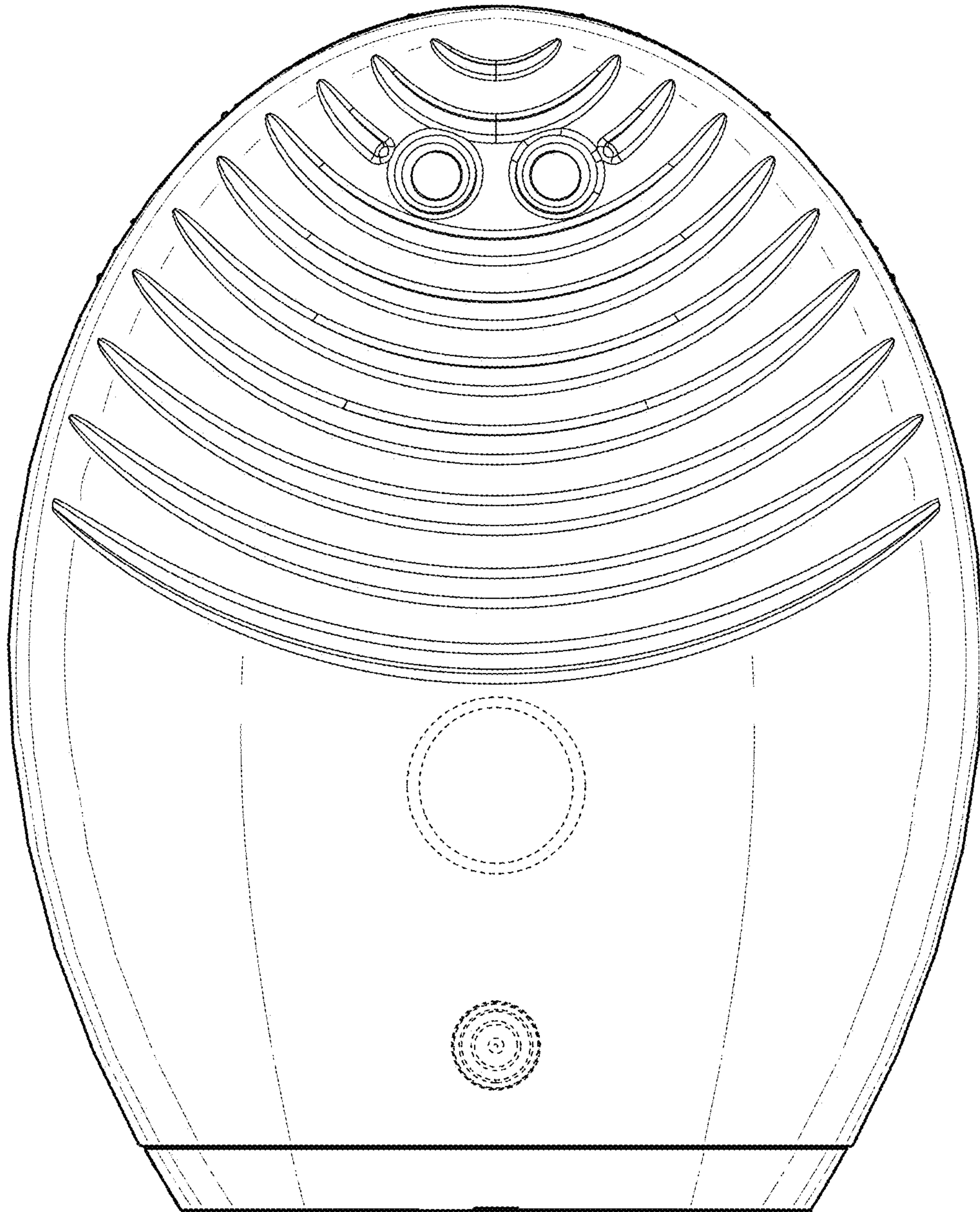

FIG. 10

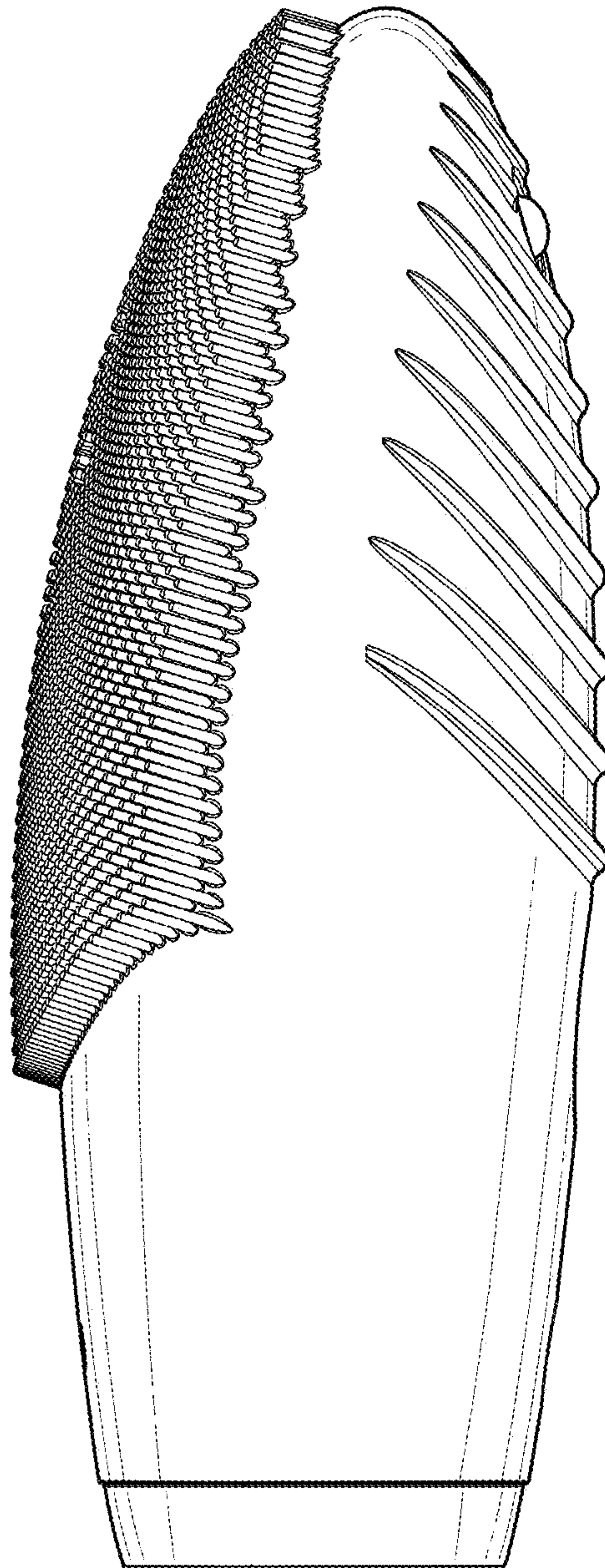

FIG. 11



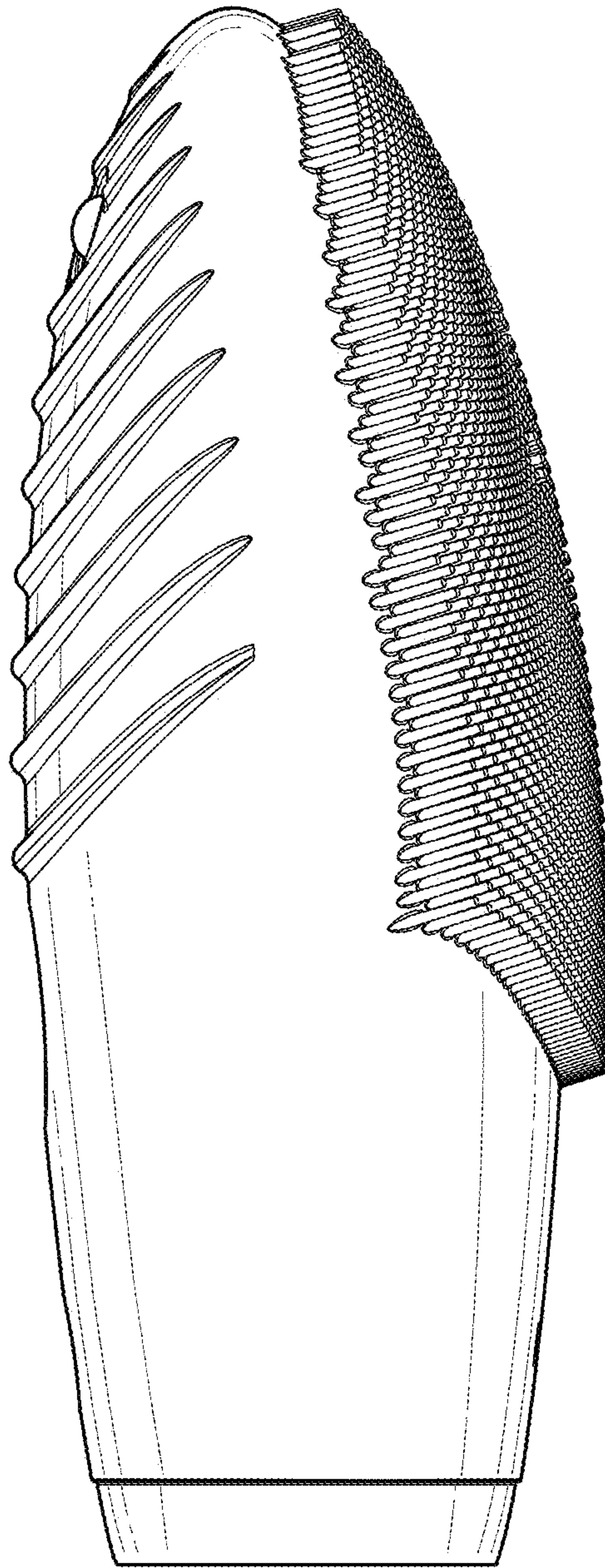

FIG. 12

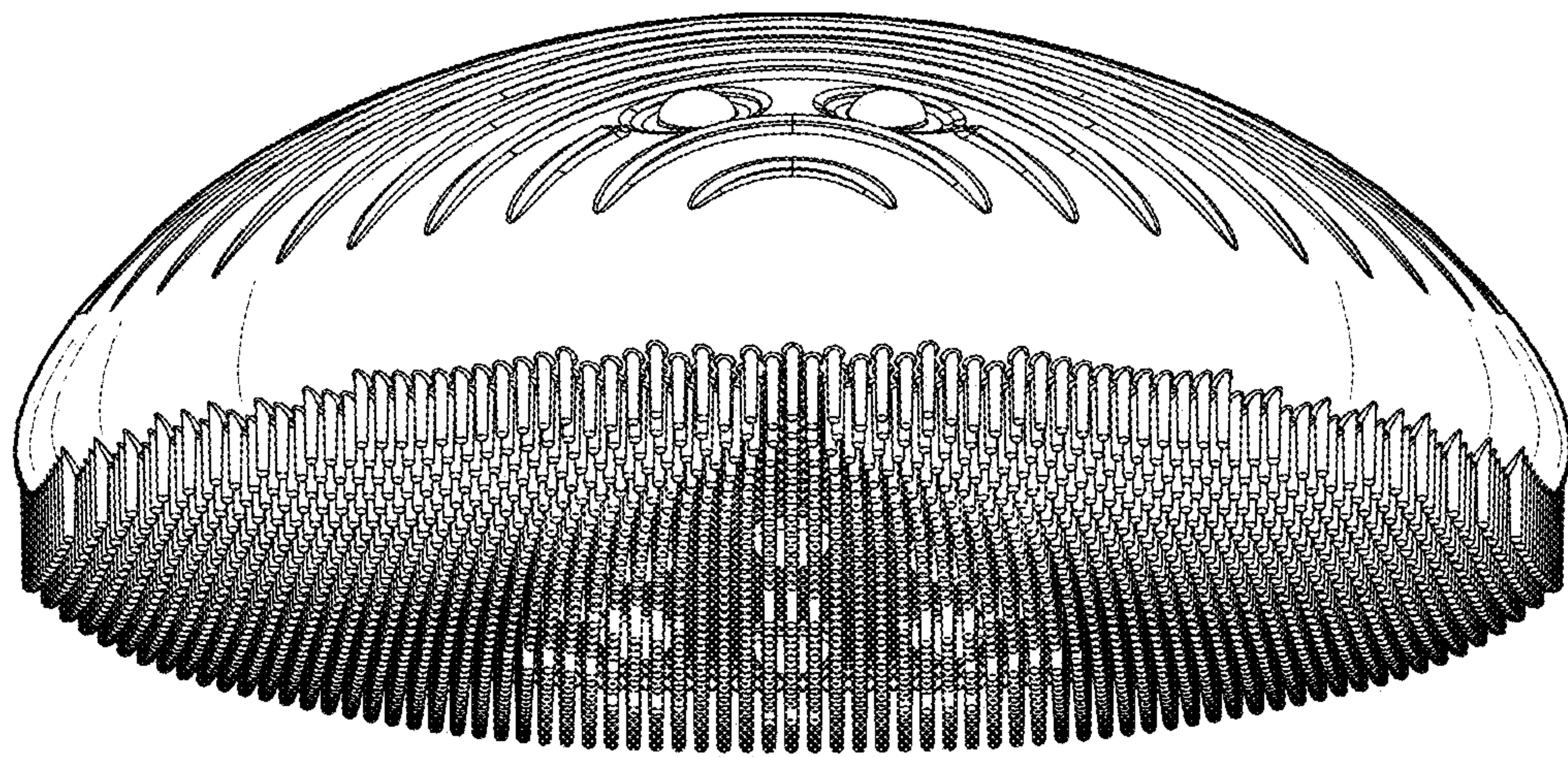

FIG. 13



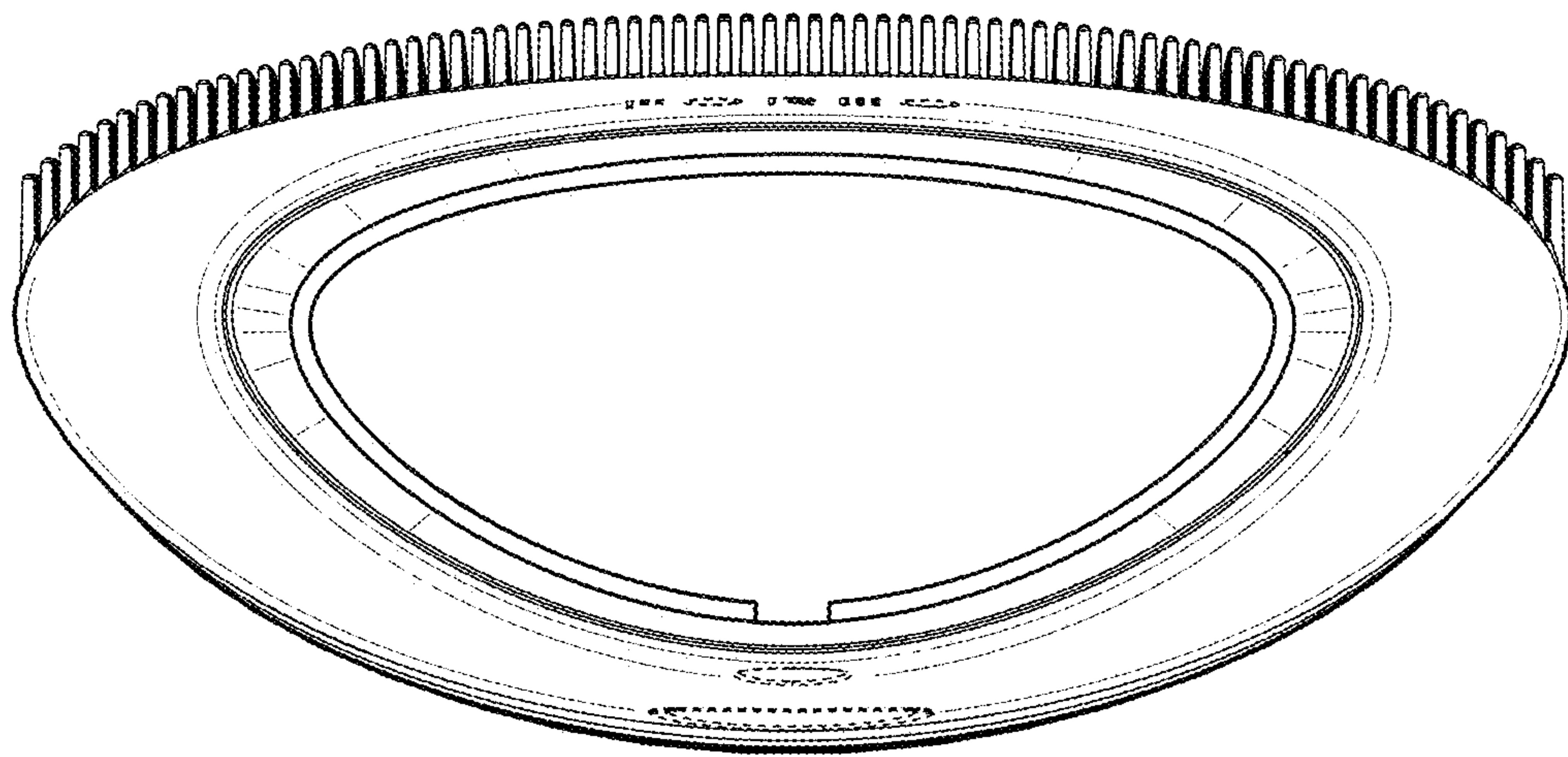

FIG. 14



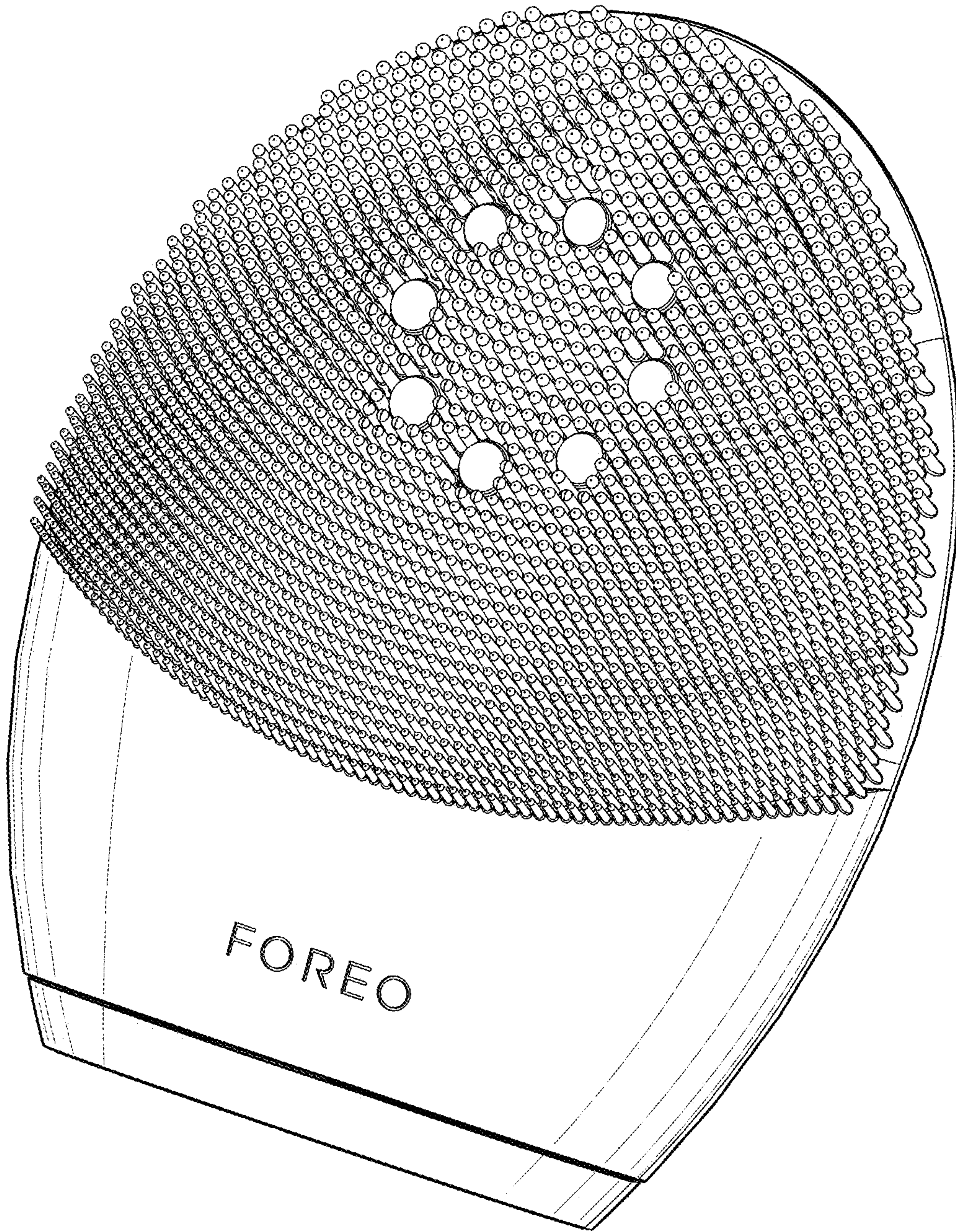

FIG. 15



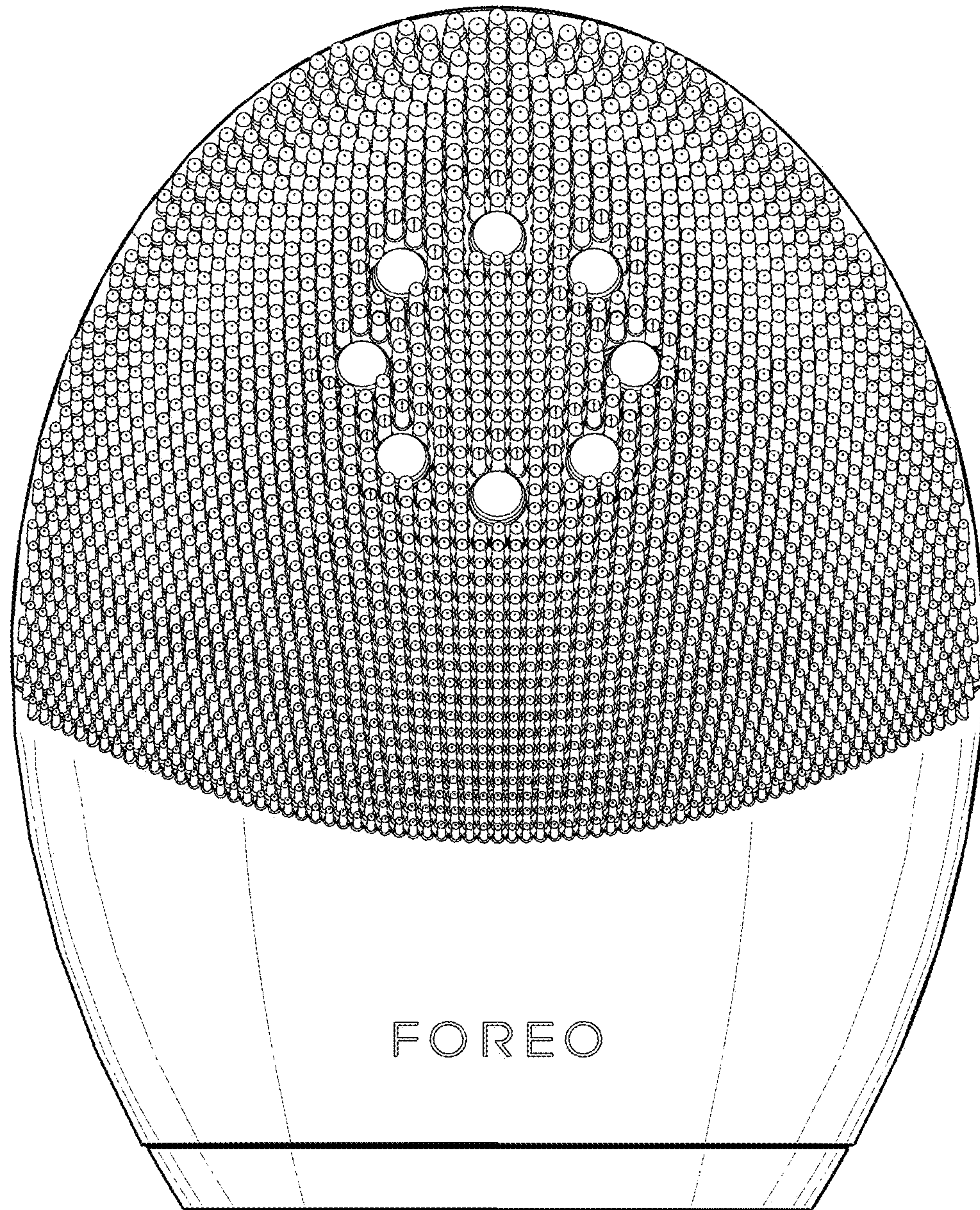

FIG. 16



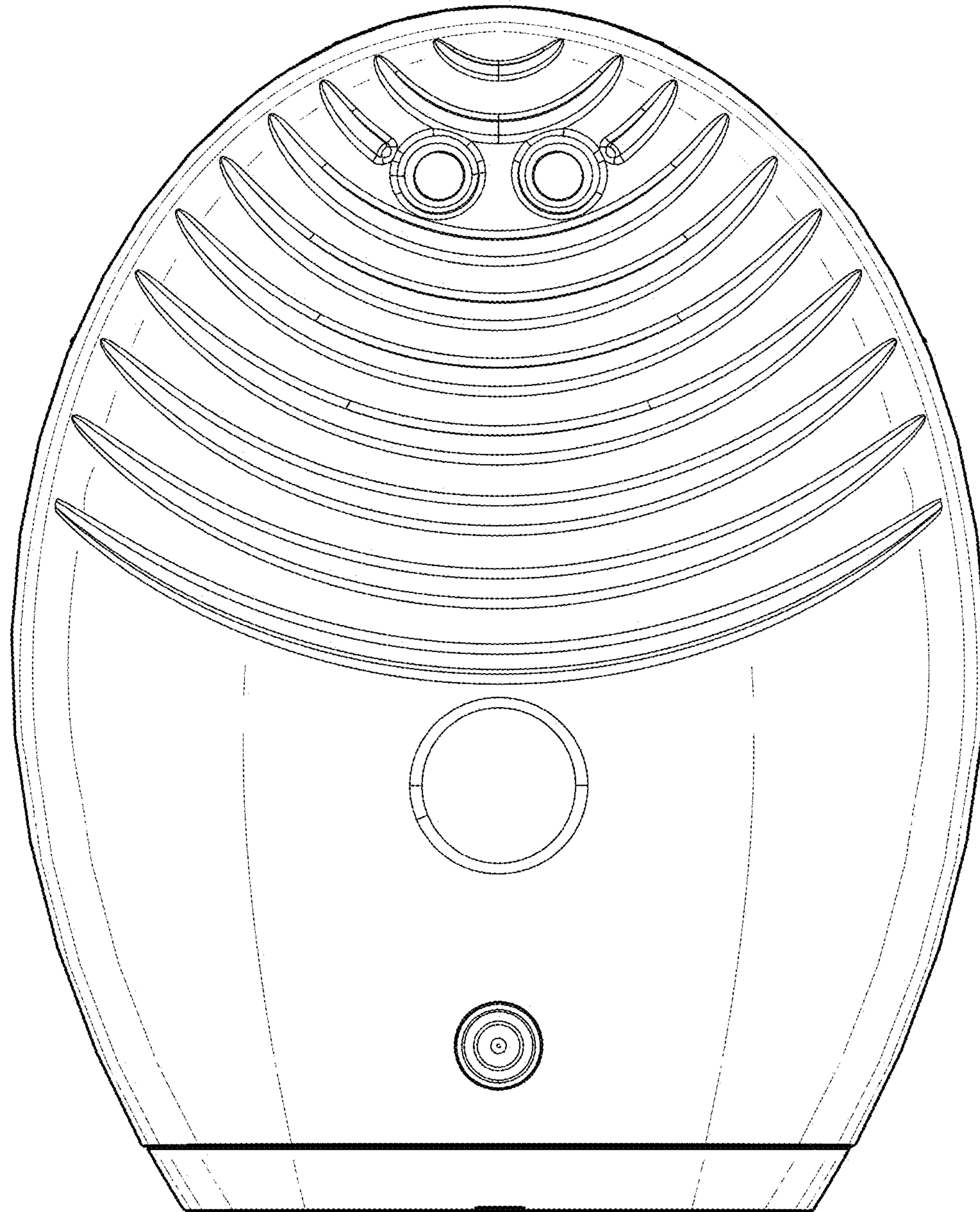

FIG. 17



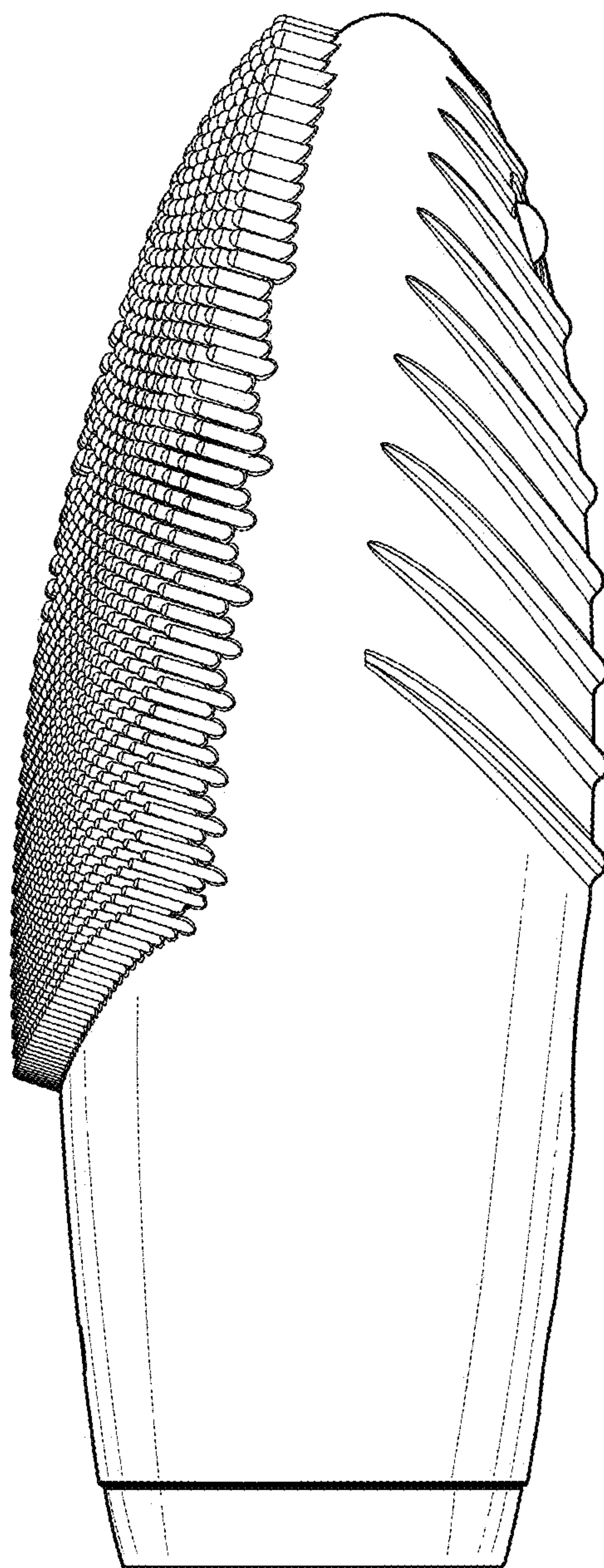

FIG. 18



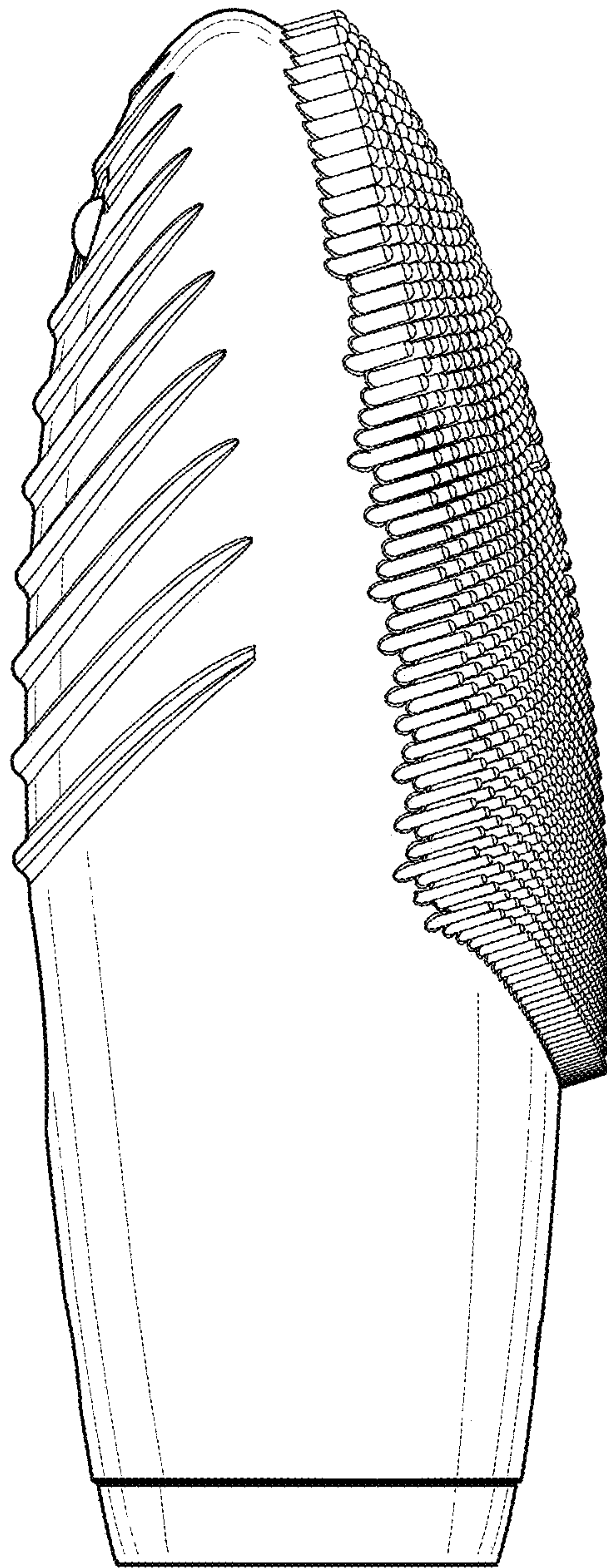

FIG. 19



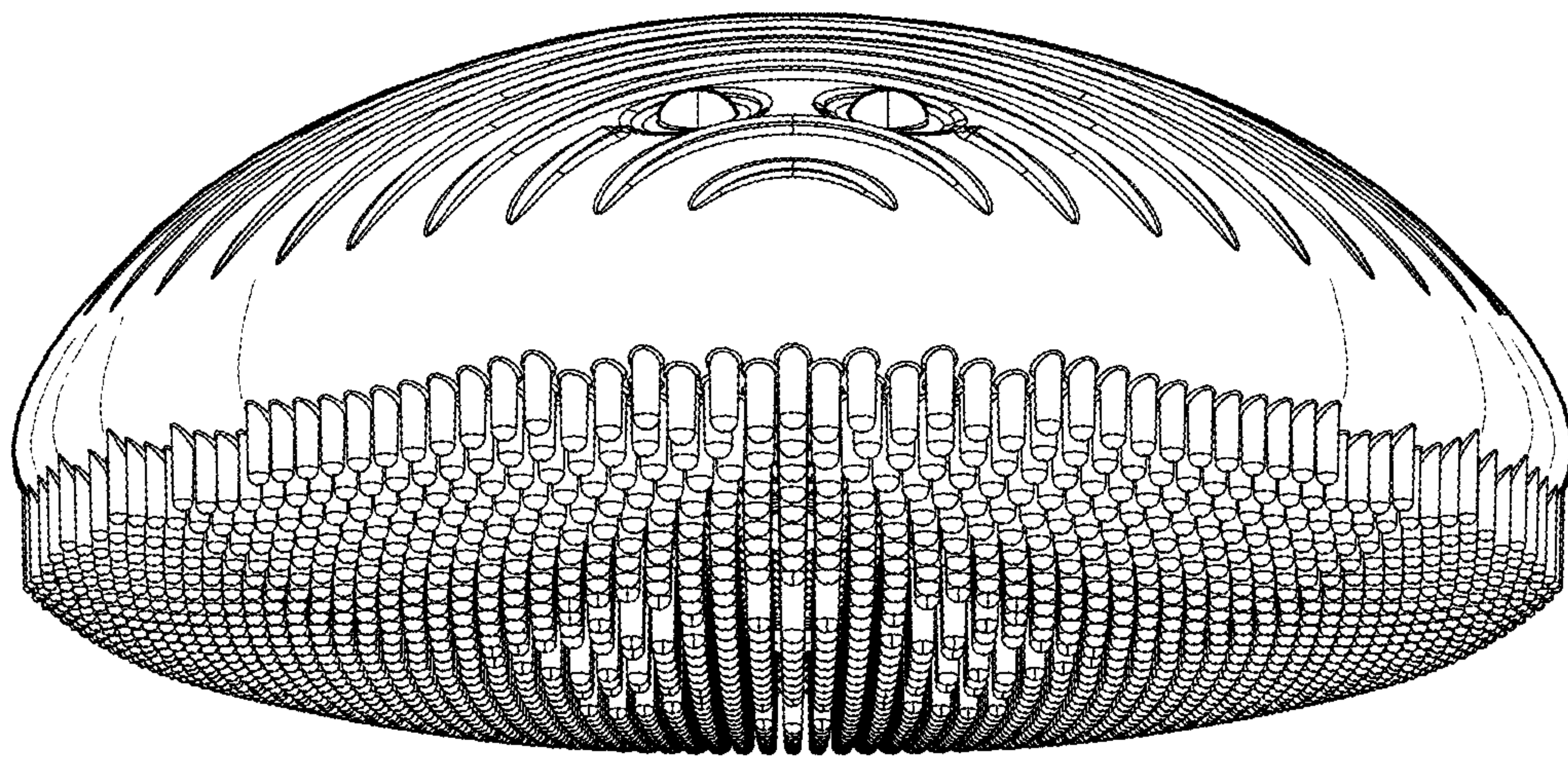

FIG. 20



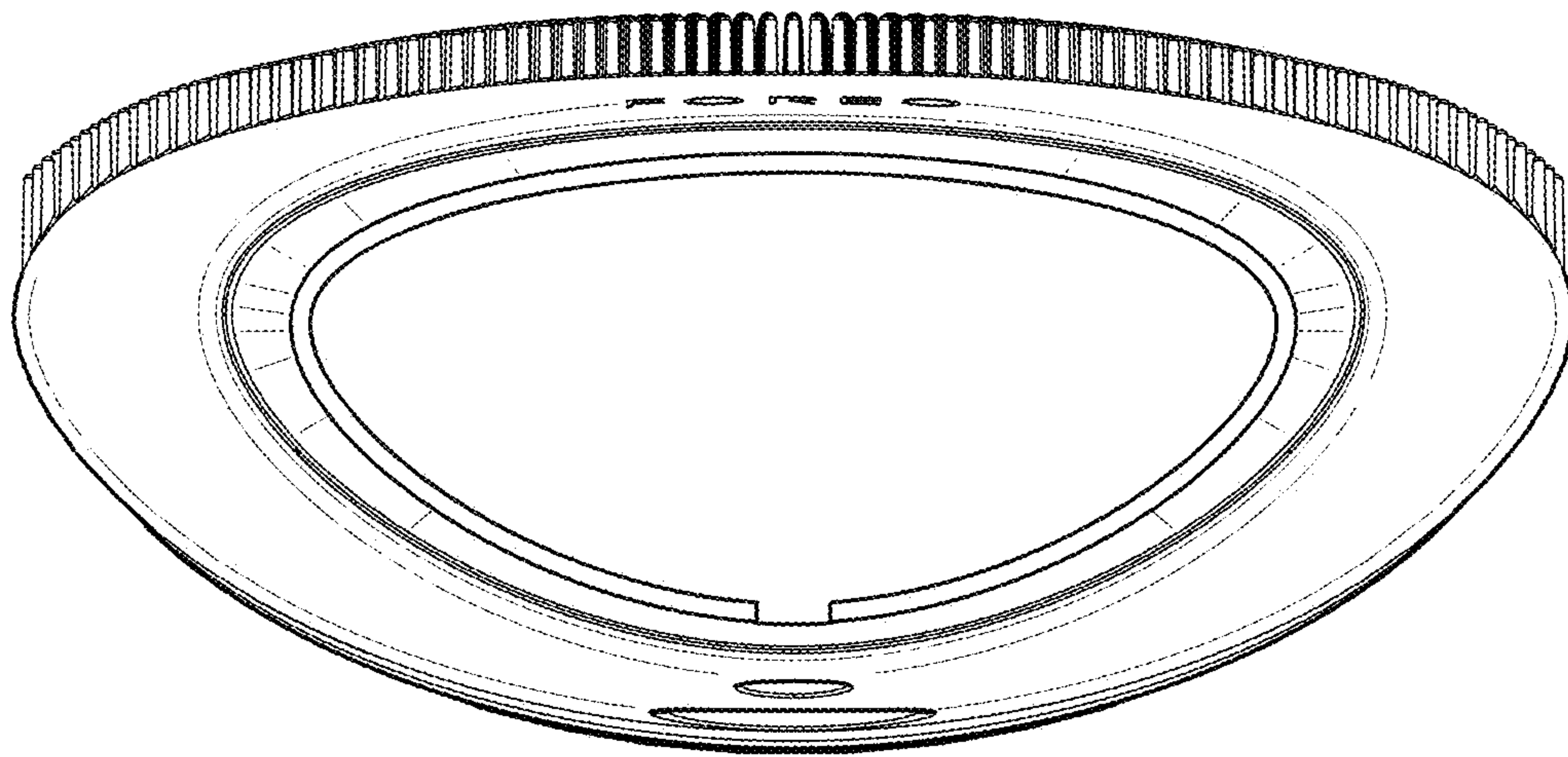

FIG. 21



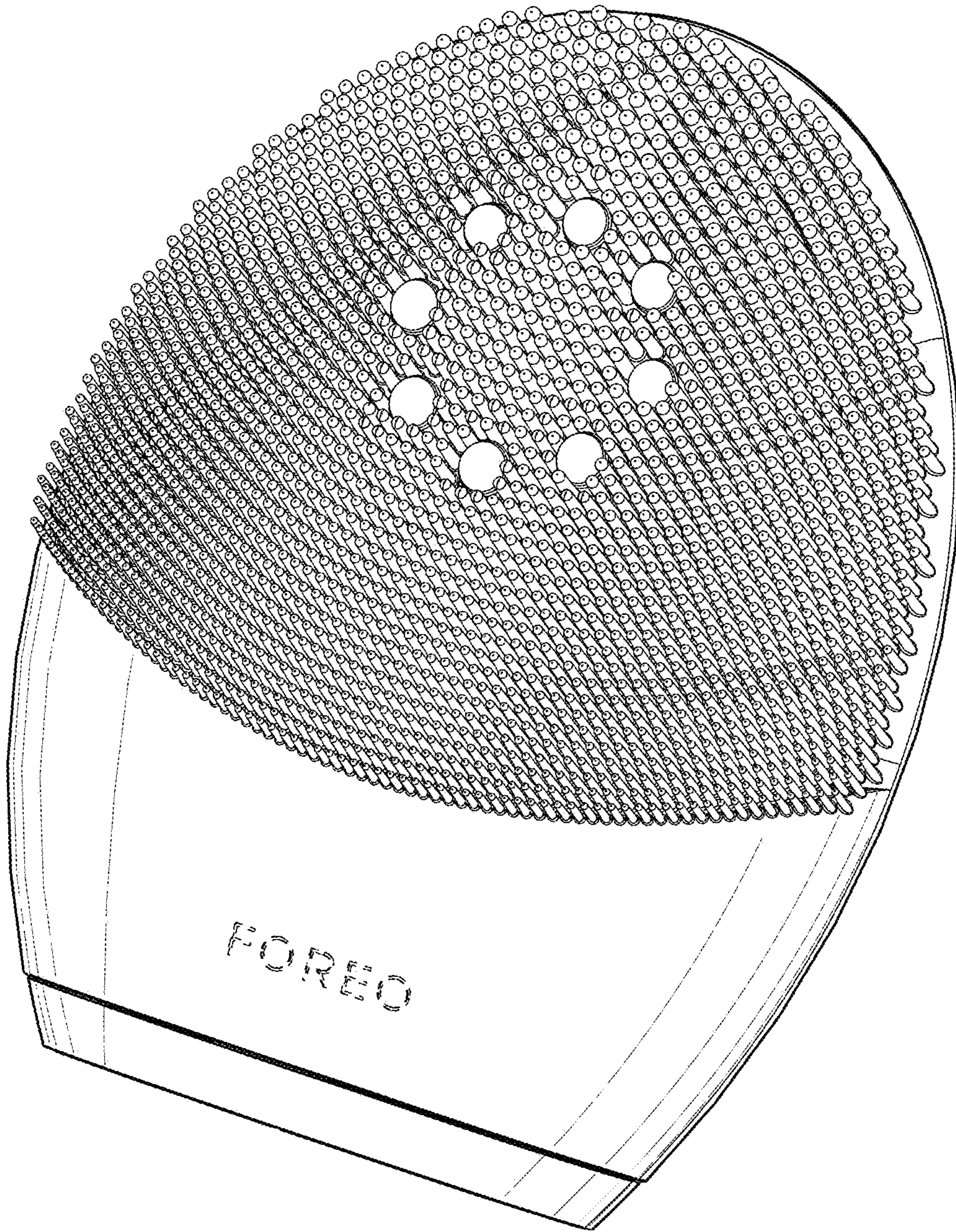

FIG. 22



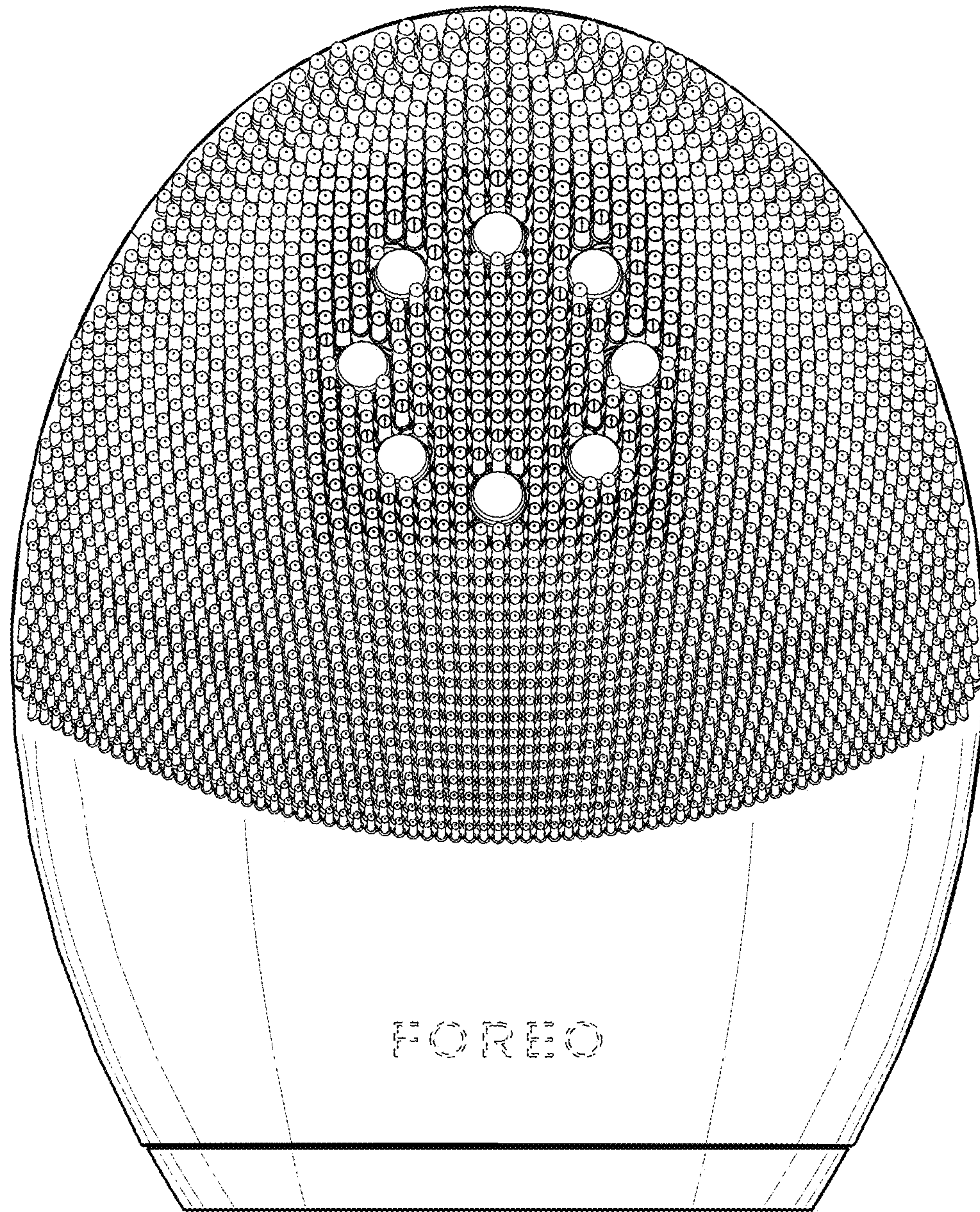

FIG. 23



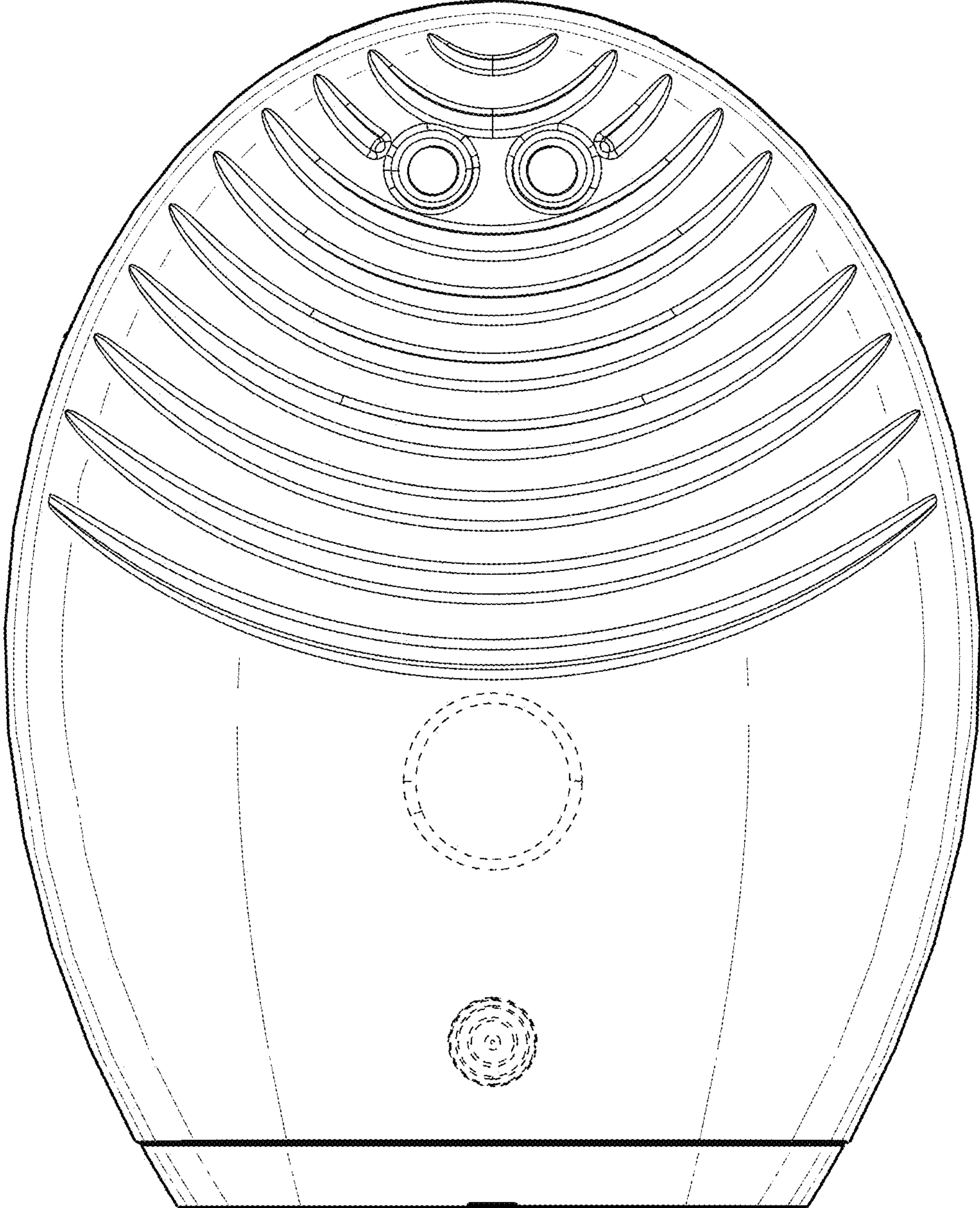

FIG. 24

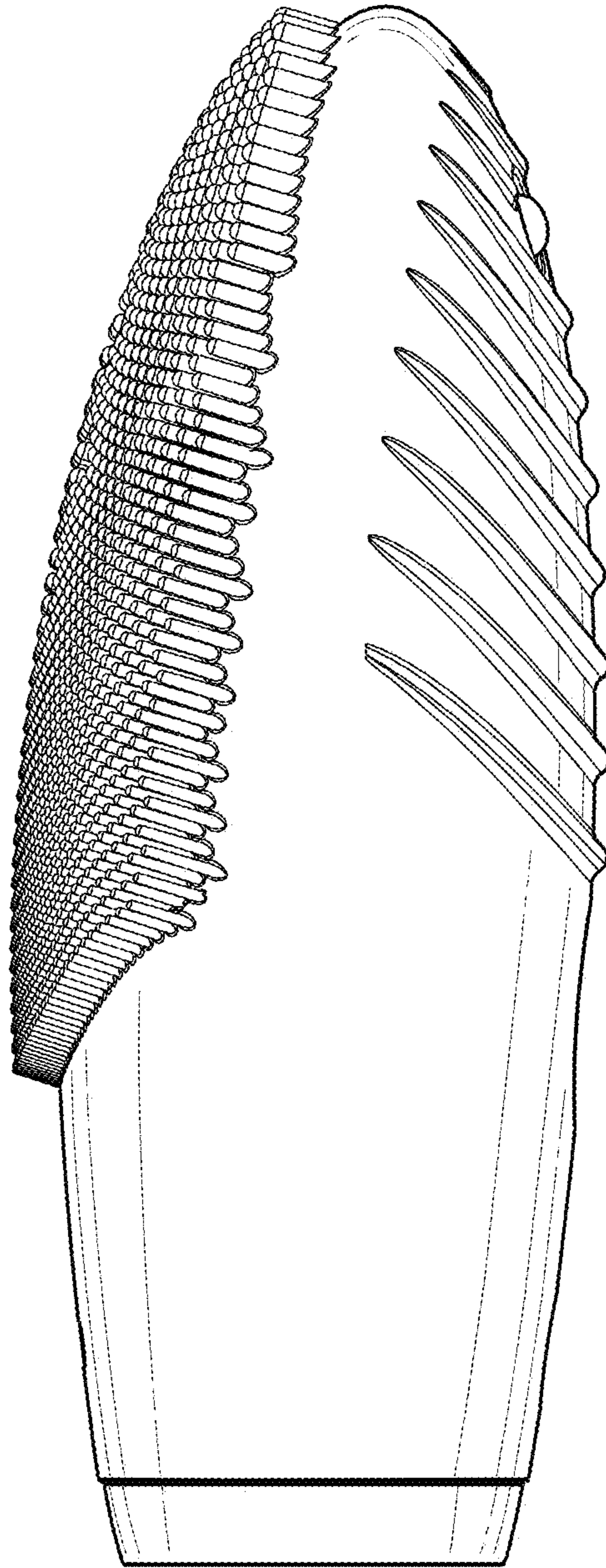

FIG. 25



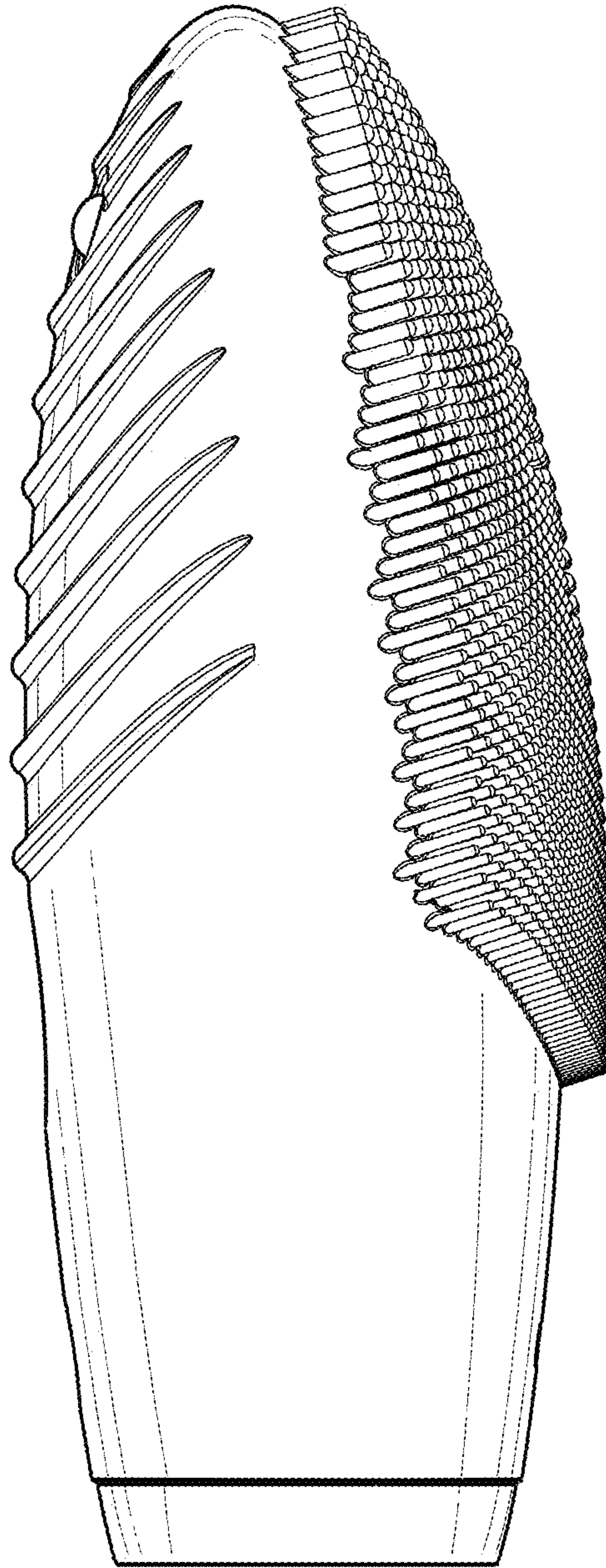

FIG. 26

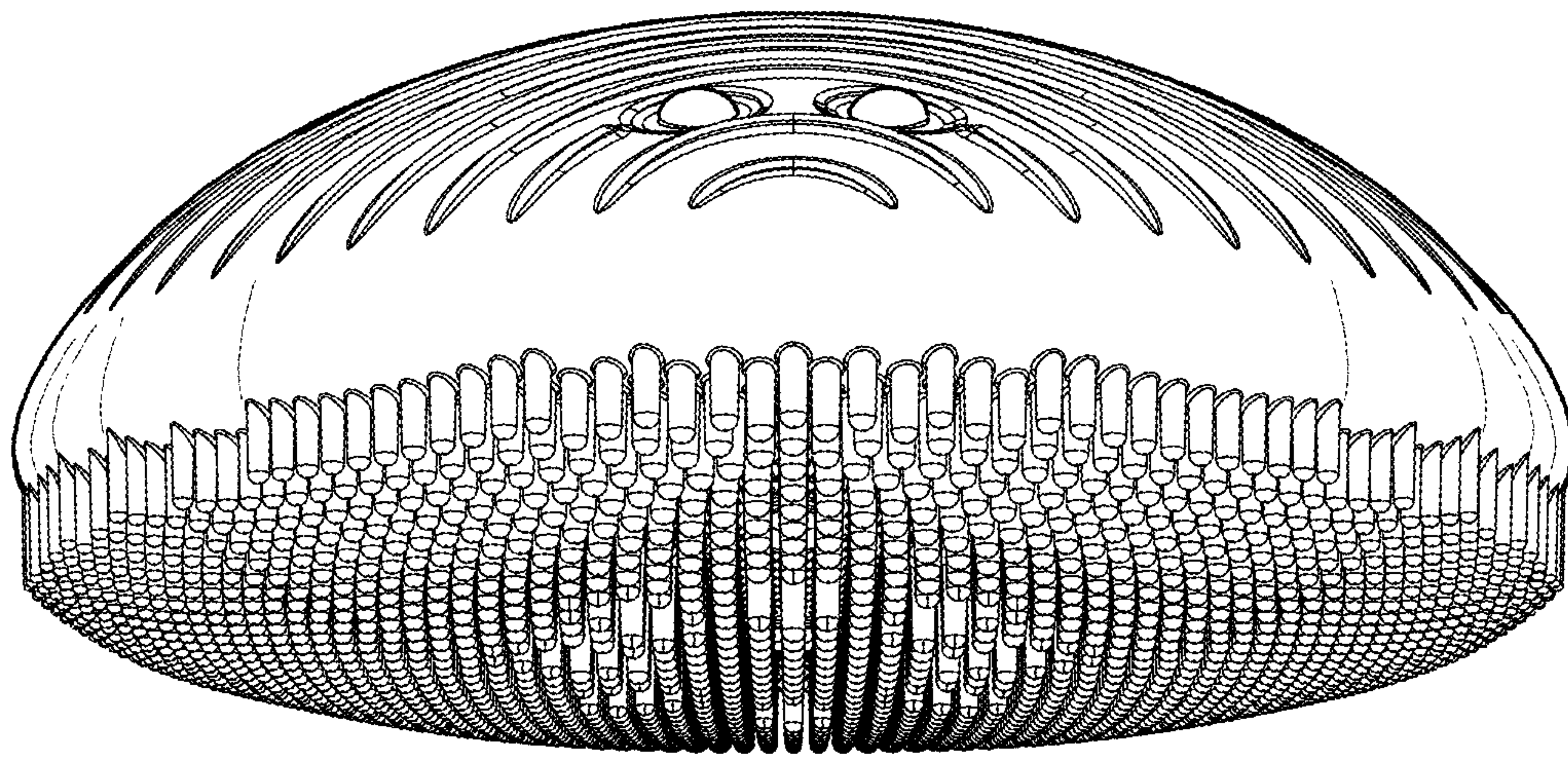

FIG. 27



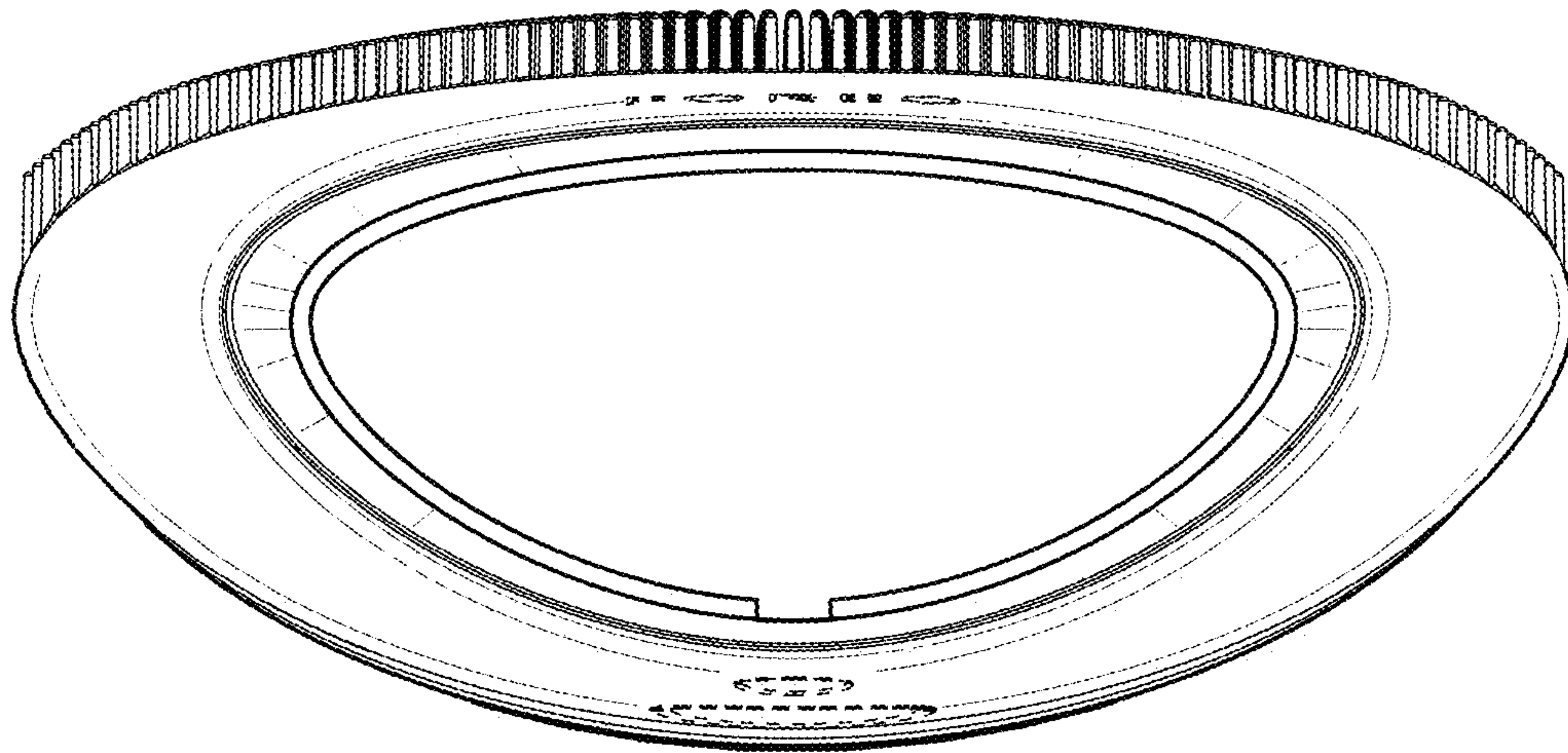

FIG. 28