



US00D882045S

(12) **United States Design Patent**  
**Cochran**

(10) **Patent No.:** **US D882,045 S**  
(45) **Date of Patent:** **\*\* Apr. 21, 2020**

(54) **GUTTER DOWNSPOUT PROTECTOR**

(71) Applicant: **Stephen Cochran**, Winder, GA (US)

(72) Inventor: **Stephen Cochran**, Winder, GA (US)

(\*\*) Term: **15 Years**

(21) Appl. No.: **29/640,548**

(22) Filed: **Mar. 15, 2018**

(51) **LOC (12) Cl.** ..... **23-01**

(52) **U.S. Cl.**  
USPC ..... **D23/267**; D23/259

(58) **Field of Classification Search**  
USPC ..... D23/259, 260, 267, 209, 365, 261, 268;  
D25/119, 121-124, 133, 139, 141-142;  
52/11-16, 101, 60, 96-97; 137/146, 151  
CPC ... E04D 13/076; E04D 13/072; E04D 13/064;  
E04D 13/068; E04D 13/158; E04D  
13/0641; E04D 13/0459; E04D 13/0477;  
E04D 13/0481; E04D 13/15; E04D  
13/0431; E04D 13/0645; E04D 13/08  
See application file for complete search history.

(56) **References Cited**

U.S. PATENT DOCUMENTS

233,853	A	11/1880	Heafer	
906,562	A	12/1908	Rue et al.	
1,471,215	A *	10/1923	Sigman	..... E04D 13/08 210/446
2,927,596	A *	3/1960	Carlson	..... E02B 13/02 137/146
2,930,392	A *	3/1960	Smith	..... E04D 13/08 137/119.06

(Continued)

Primary Examiner — Amy C Wierenga

(74) Attorney, Agent, or Firm — Andrew M. Harris;  
Mitch Harris, Atty at Law

(57) **CLAIM**

The ornamental design for a gutter downspout protector, as shown and described.

**DESCRIPTION**

FIG. 1 is a front view of a first embodiment of a gutter downspout protector configured for use on a downspout; FIG. 2 is a left side view of the gutter downspout protector of FIG. 1; FIG. 3 is a right side view of the gutter downspout protector of FIG. 1; FIG. 4 is a back view of the gutter downspout protector of FIG. 1; FIG. 5 is a perspective top view of the gutter downspout protector of FIG. 1; FIG. 6 is a bottom view of the gutter downspout protector of FIG. 1; FIG. 7 is an upper right perspective top view of the gutter downspout protector of FIG. 1; and FIG. 8 is an upper right perspective top view of the gutter downspout protector of FIG. 1 with an opened flap; FIG. 9 is a front view of a second embodiment of a gutter downspout protector configured for use on a downspout; FIG. 10 is a left side view of the gutter downspout protector of FIG. 9; FIG. 11 is a right side view of the gutter downspout protector of FIG. 9; FIG. 12 is a back view of the gutter downspout protector of FIG. 9; FIG. 13 is a perspective top view of the gutter downspout protector of FIG. 9; FIG. 14 is a bottom view of the gutter downspout protector of FIG. 9; FIG. 15 is an upper right perspective top view of the gutter downspout protector of FIG. 9; and, FIG. 16 is an upper right perspective top view of the gutter downspout protector of FIG. 9 with an opened flap. The light gray oblique shading shown in FIGS. 1, 5, 7-9, 13 and 15-16 and the hatch shading shown in FIGS. 4 and 12 represent a contrast in appearance only.

**1 Claim, 16 Drawing Sheets**

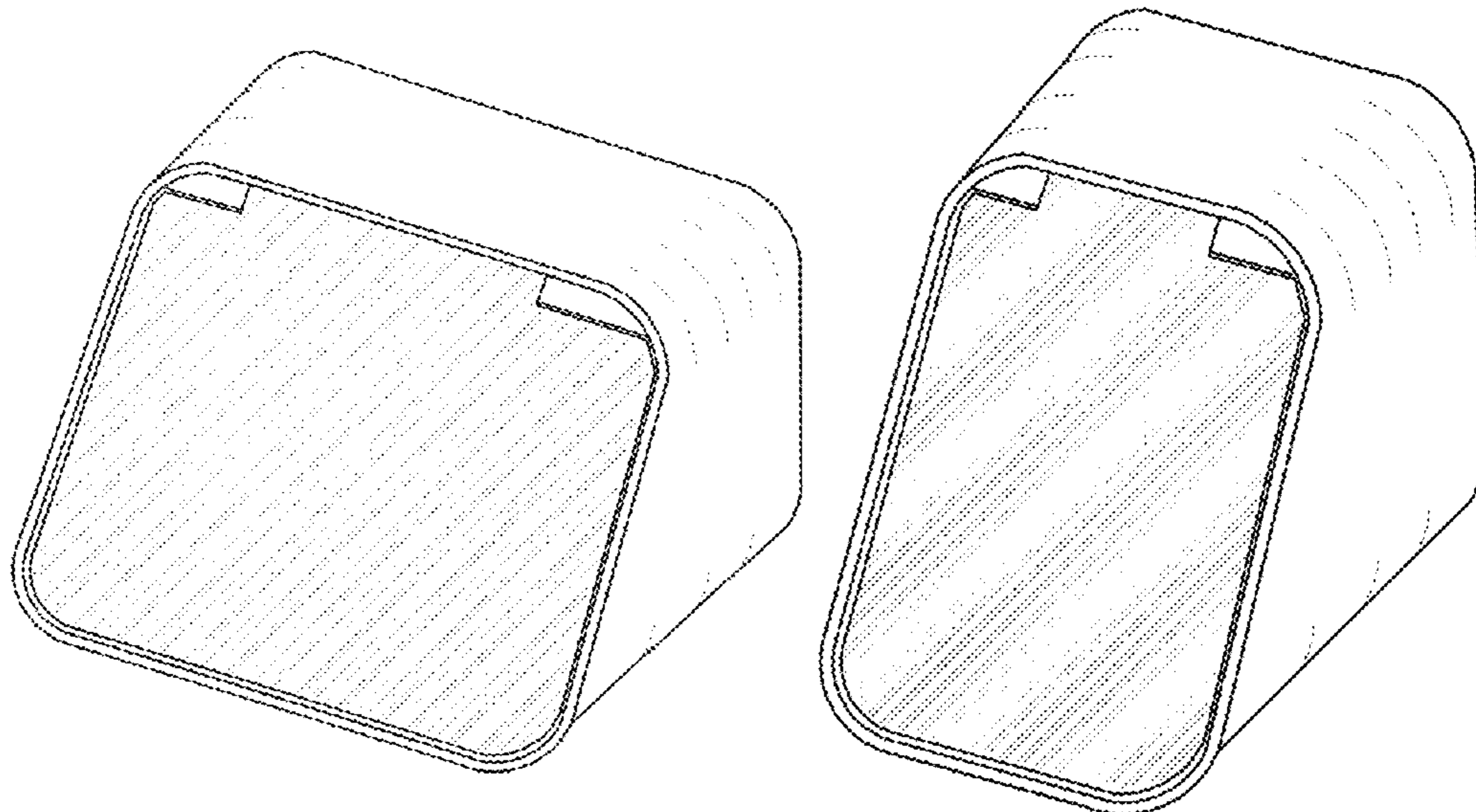

(56)

References Cited

U.S. PATENT DOCUMENTS

3,990,474 A *	11/1976	Harms	.....	E04D 13/08	137/873	7,958,680 B2 *	6/2011	DeNooy	.....	F15D 1/001	52/12
4,174,913 A	11/1979	Schliesser				8,006,720 B1 *	8/2011	Kotansky	.....	E04D 13/08	137/873
4,356,087 A	10/1982	Miles				8,097,151 B2 *	1/2012	Allan	.....	E03B 3/03	210/162
4,757,638 A *	7/1988	Lafforthun	.....	A01M 23/08	119/427	8,475,654 B1 *	7/2013	Smith	.....	E04D 13/0767	210/162
D301,164 S *	5/1989	Weaver	.....	52/16		D780,894 S *	3/2017	French	.....	D23/267	
5,230,798 A *	7/1993	Rogman	.....	B01D 29/23	210/447	2002/0153049 A1 *	10/2002	Brown	.....	E04D 13/08	138/96 R
D372,301 S *	7/1996	Lavrov	.....	D23/267		2004/0040219 A1 *	3/2004	Bacik	.....	E04D 13/064	52/11
5,709,051 A *	1/1998	Mazziotti	.....	E04D 13/076	210/162	2005/0092372 A1	5/2005	Wade			
6,024,127 A *	2/2000	Johnson	.....	E04D 13/08	137/357	2008/0295418 A1 *	12/2008	Edell	.....	E04D 13/08	52/16
D428,121 S *	7/2000	Missick	.....	D23/261		2011/0173897 A1 *	7/2011	Schneider	.....	E04D 13/08	52/16
6,474,365 B1	11/2002	Brown et al.				2016/0040820 A1 *	2/2016	Morris	.....	F15D 1/04	138/39
D552,219 S *	10/2007	Beutler	.....	D23/267		2018/0016792 A1 *	1/2018	Valdez	.....	A01M 29/30	
D552,221 S *	10/2007	Beutler	.....	D23/267		2018/0305932 A1 *	10/2018	Veldhoff	.....	E04D 13/08	
D555,772 S *	11/2007	McCall	.....	D23/261							
D556,865 S *	12/2007	Trangsrud	.....	D23/267							
7,919,002 B1 *	4/2011	Hurtado	.....	E04D 13/08	210/162						

\* cited by examiner

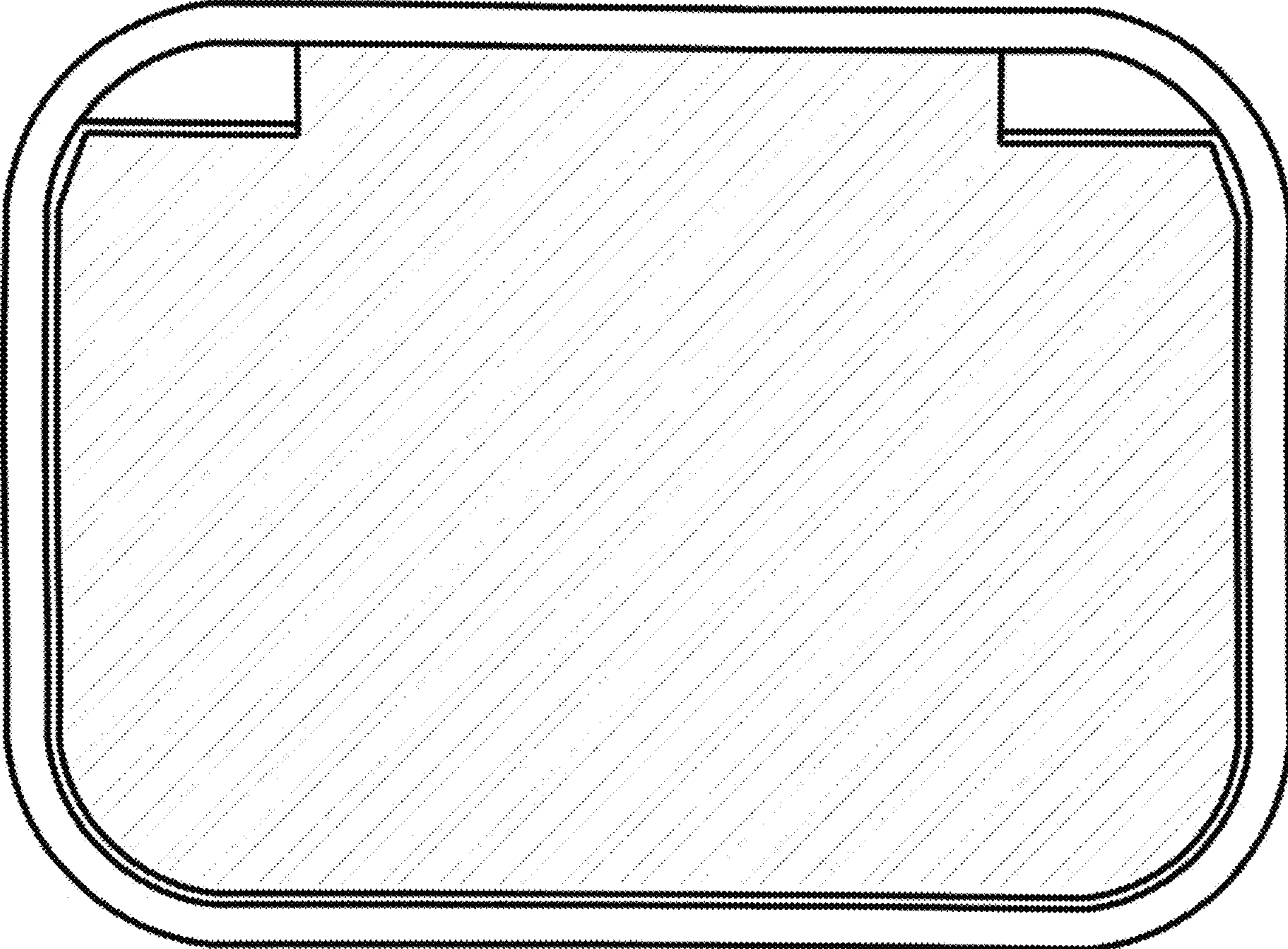
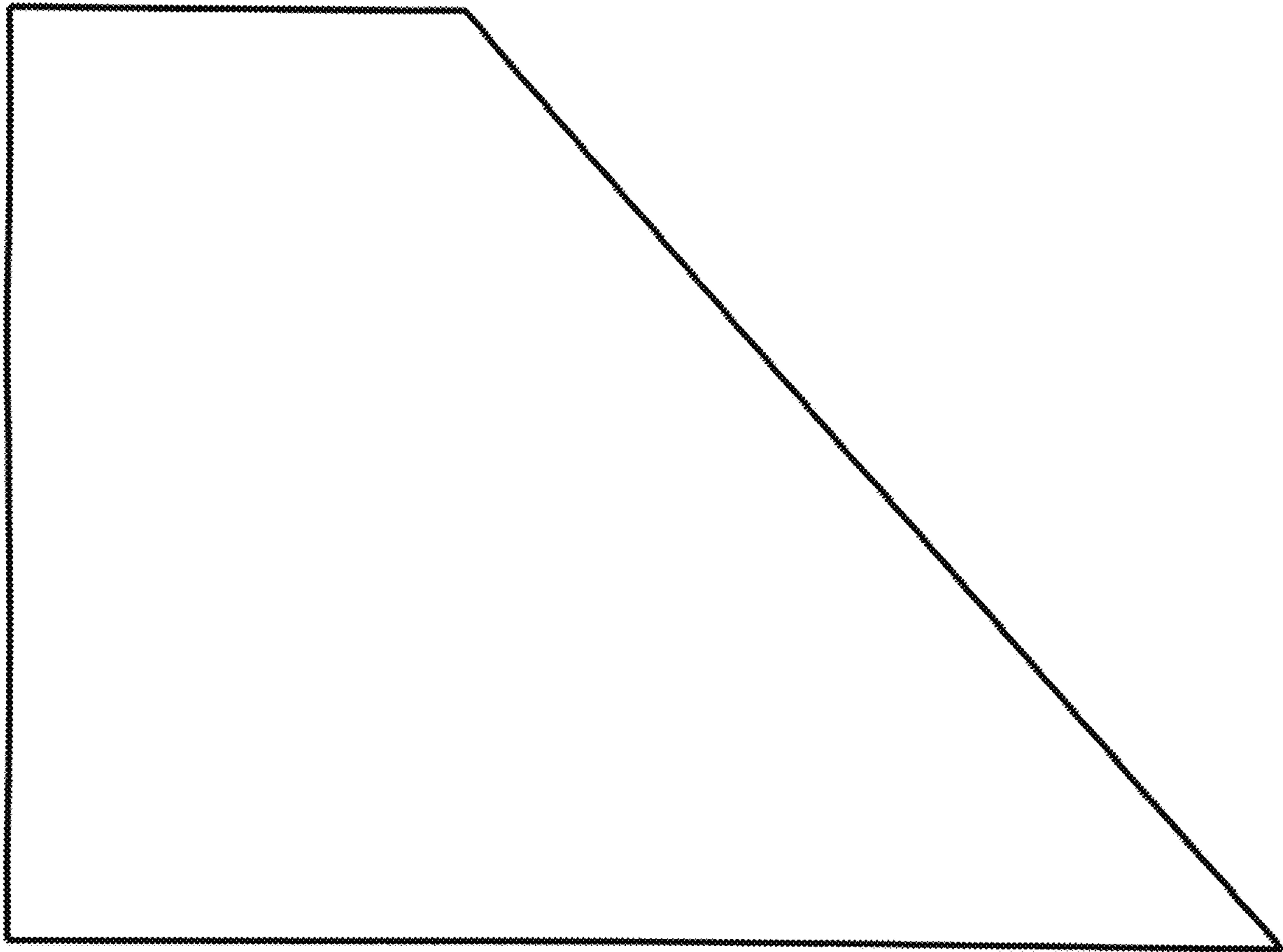

Fig. 1





**Fig. 2**

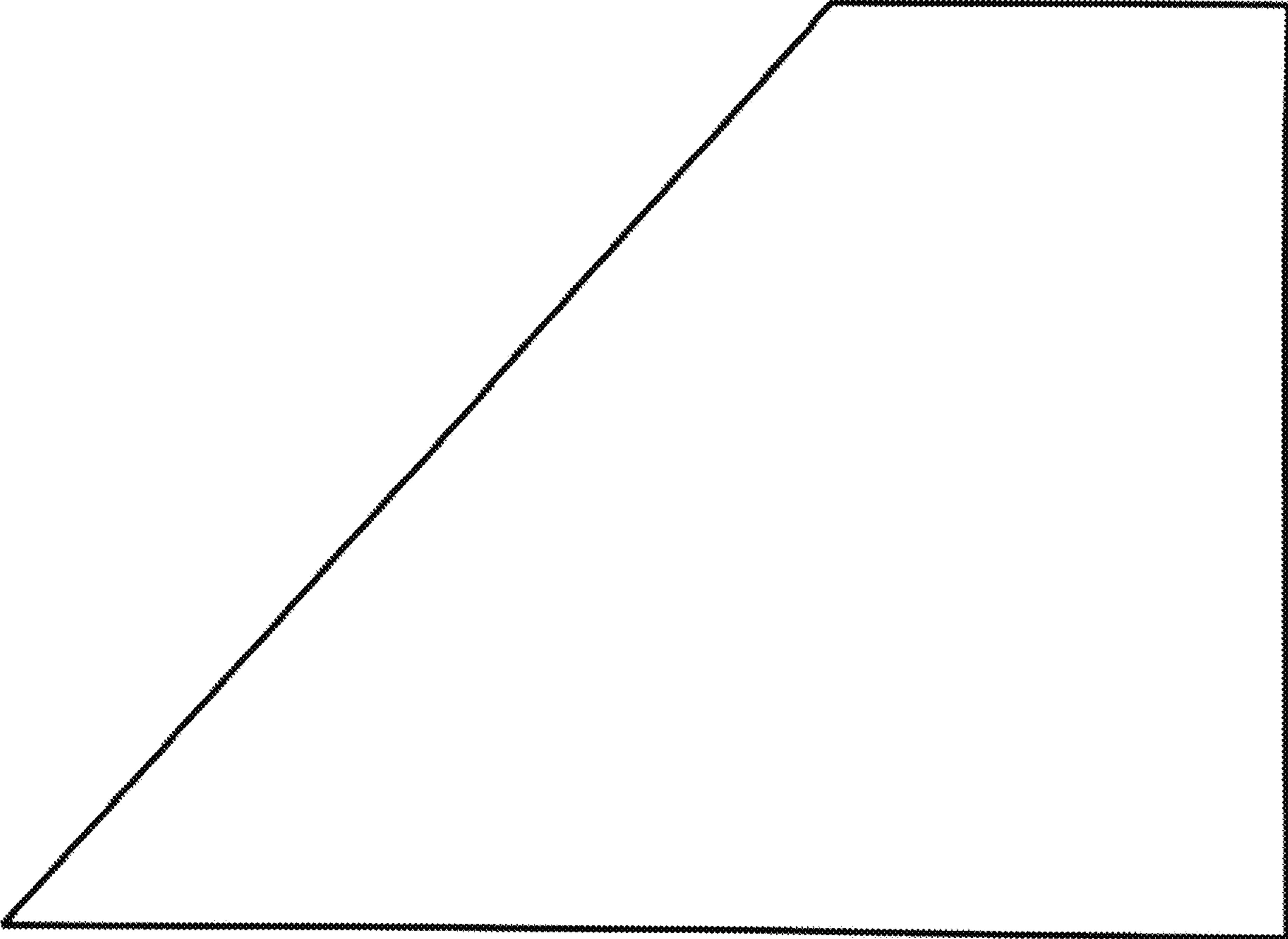

Fig. 3

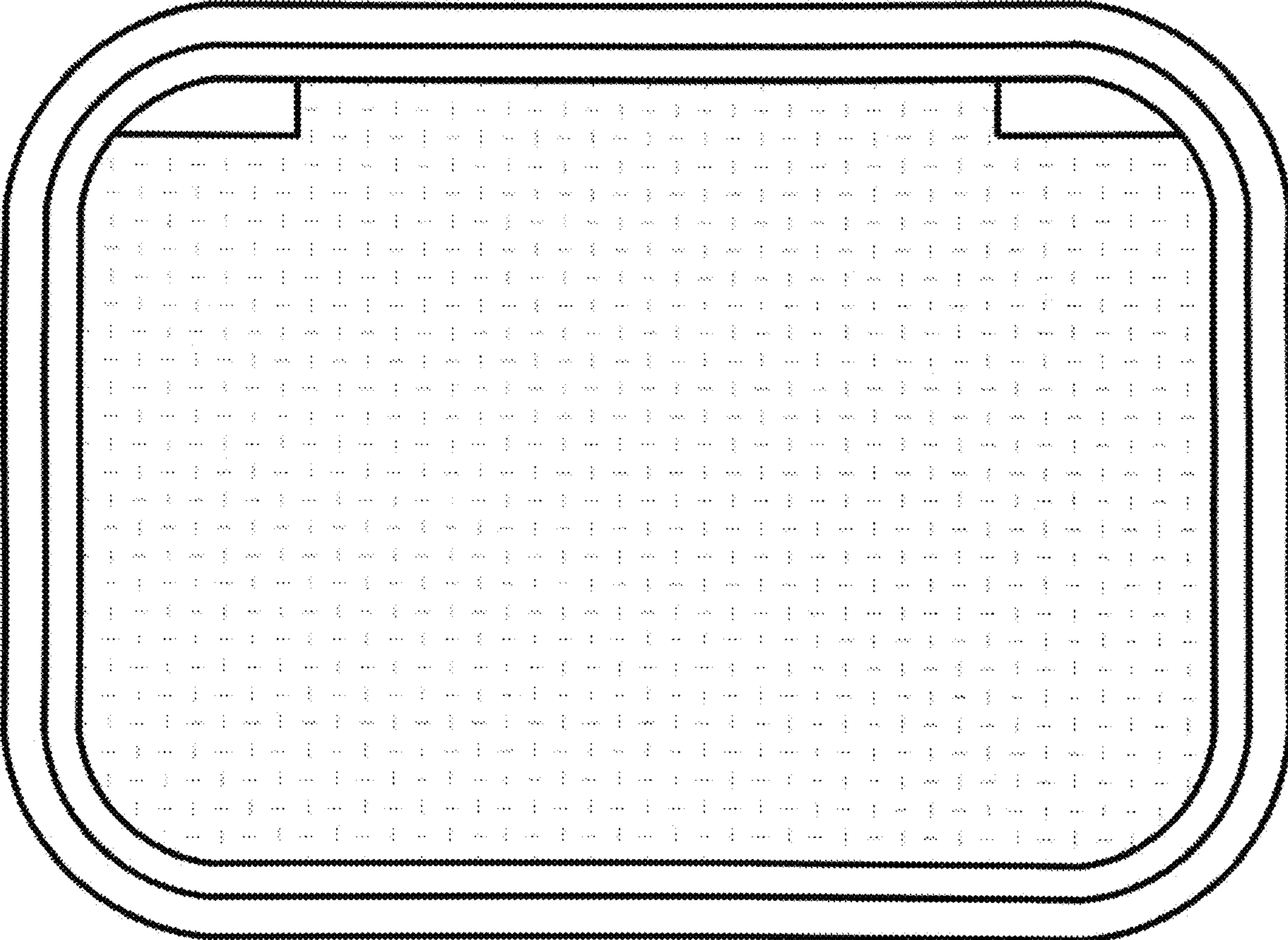

Fig. 4

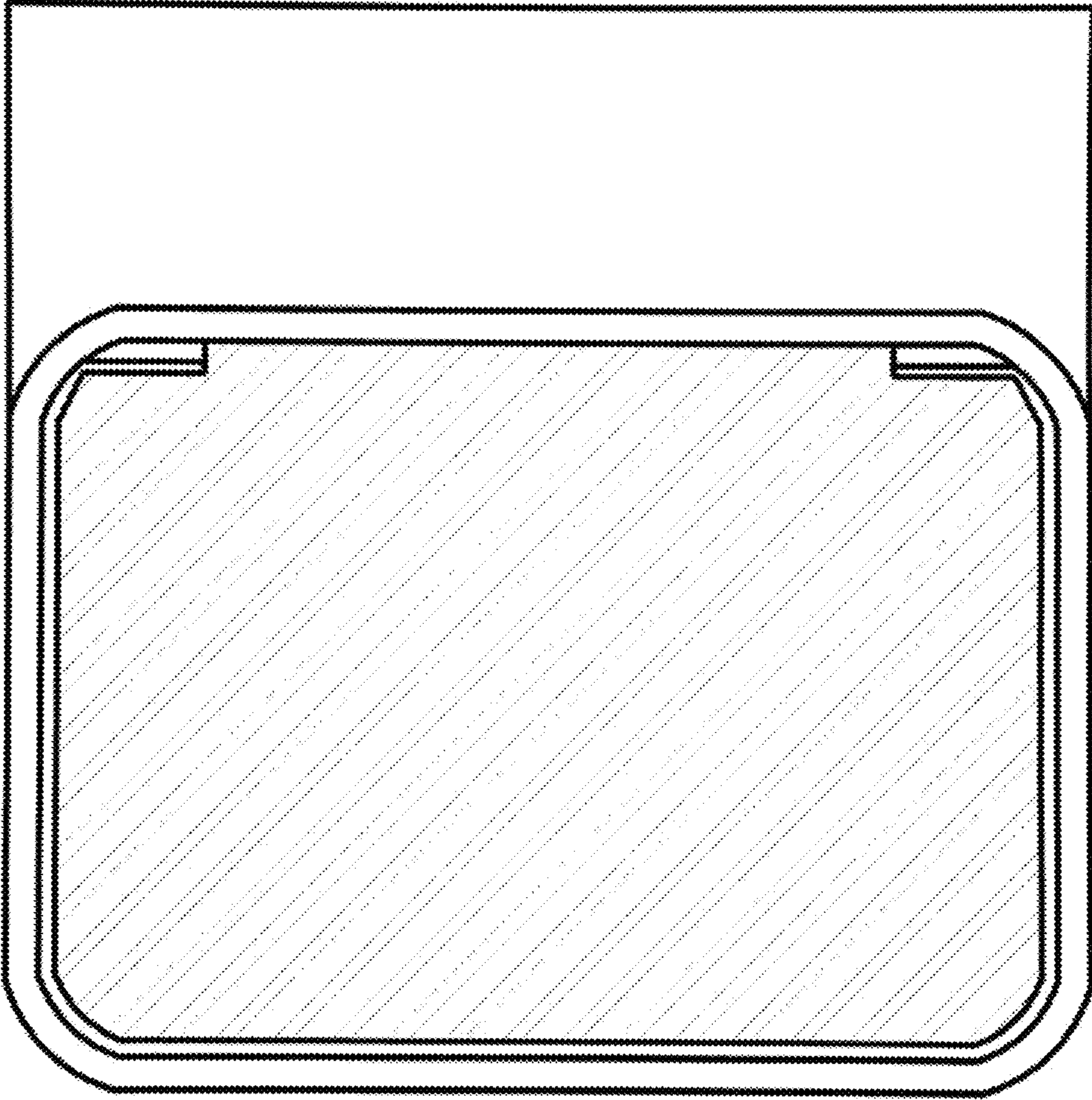
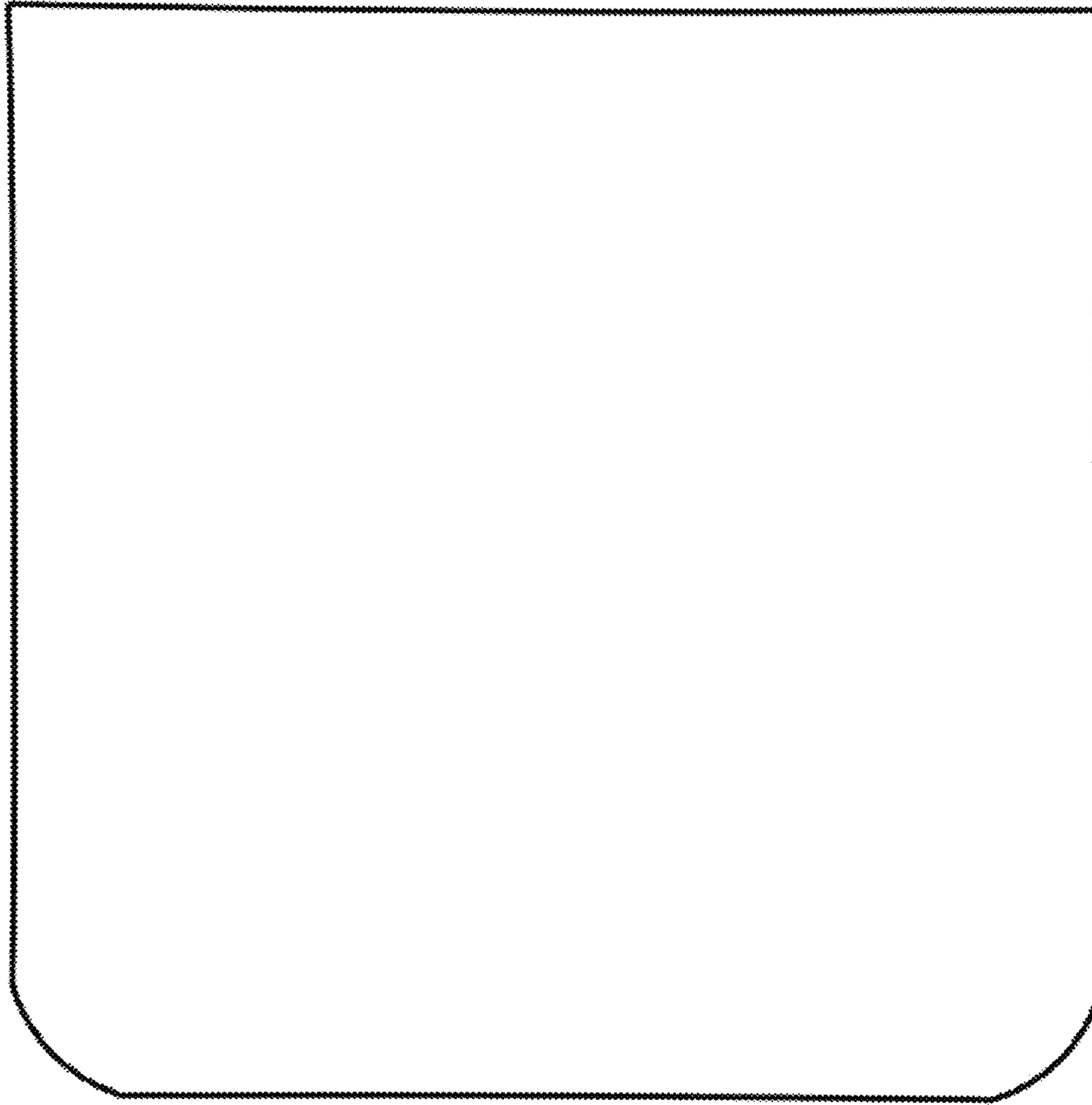
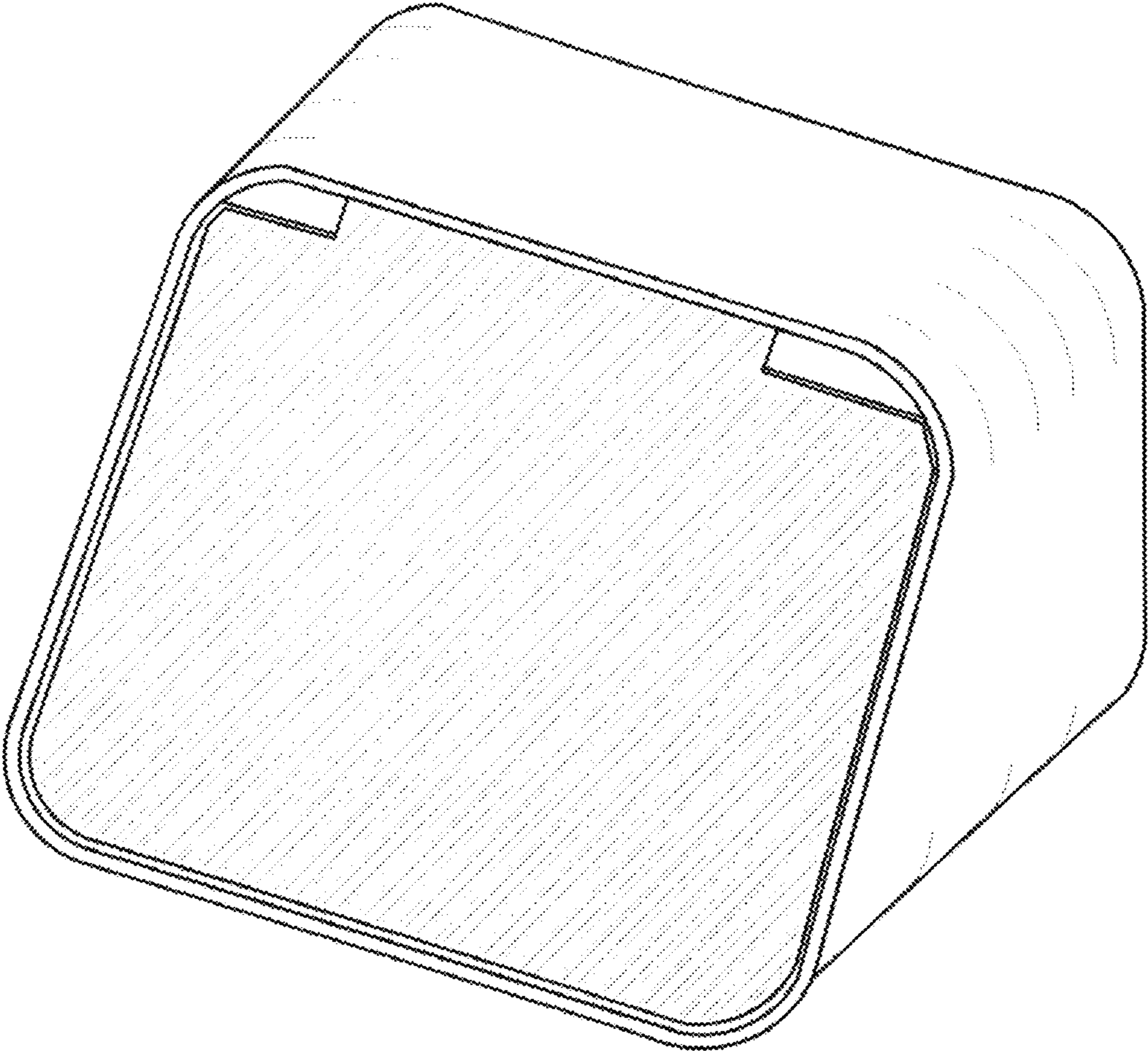

Fig. 5



**Fig. 6**





**Fig. 7**

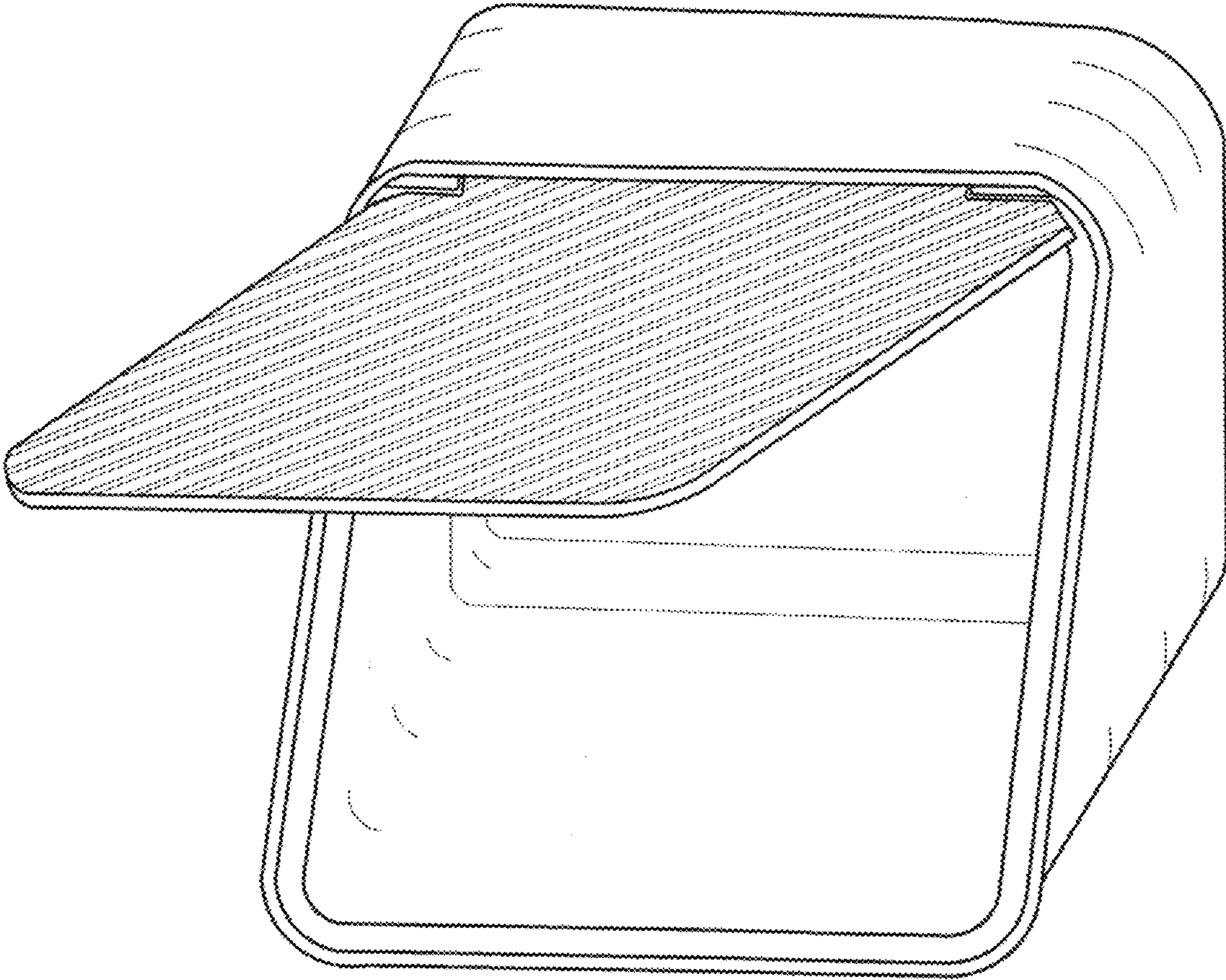
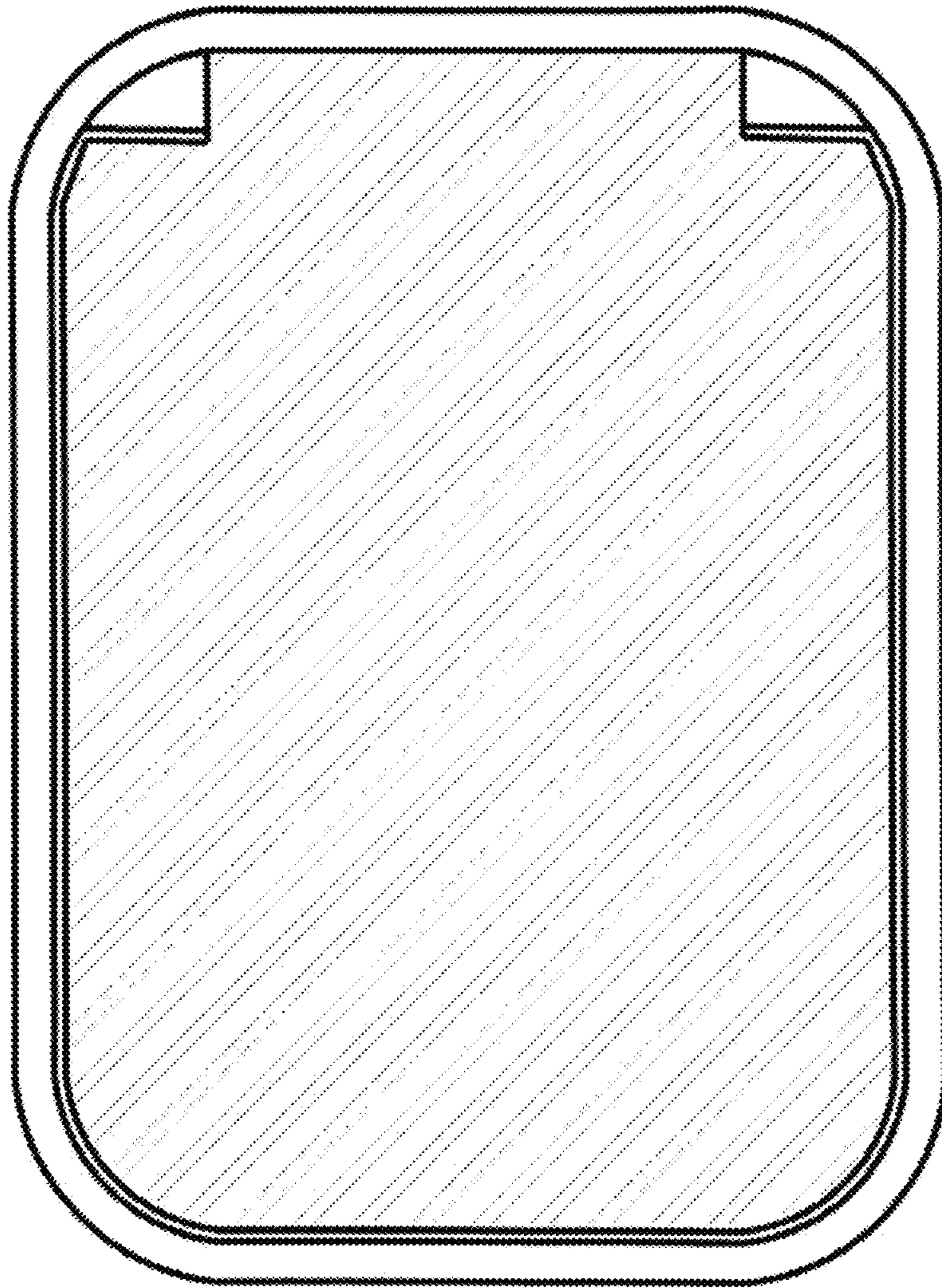

Fig. 8



**Fig. 9**

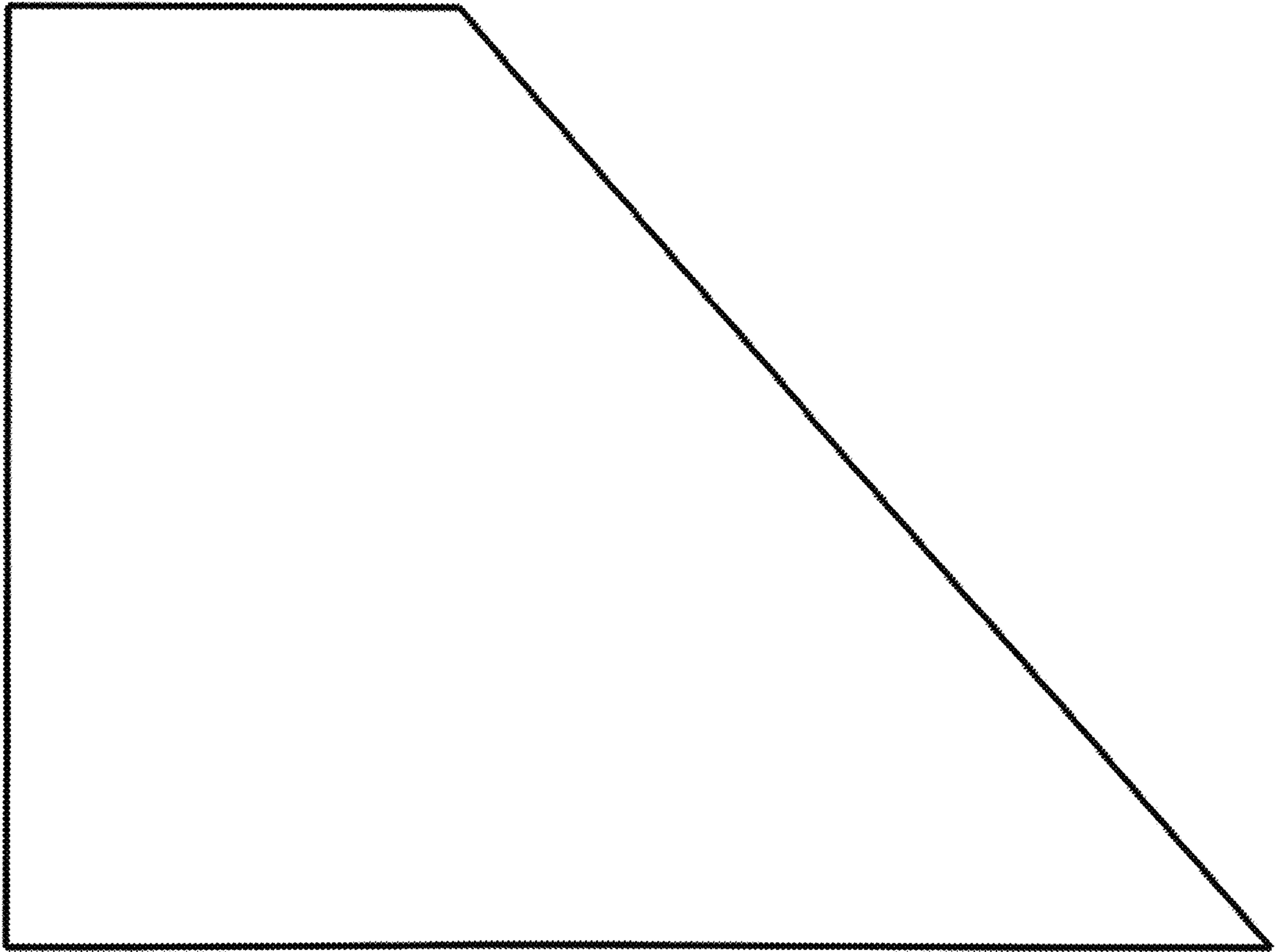

Fig. 10



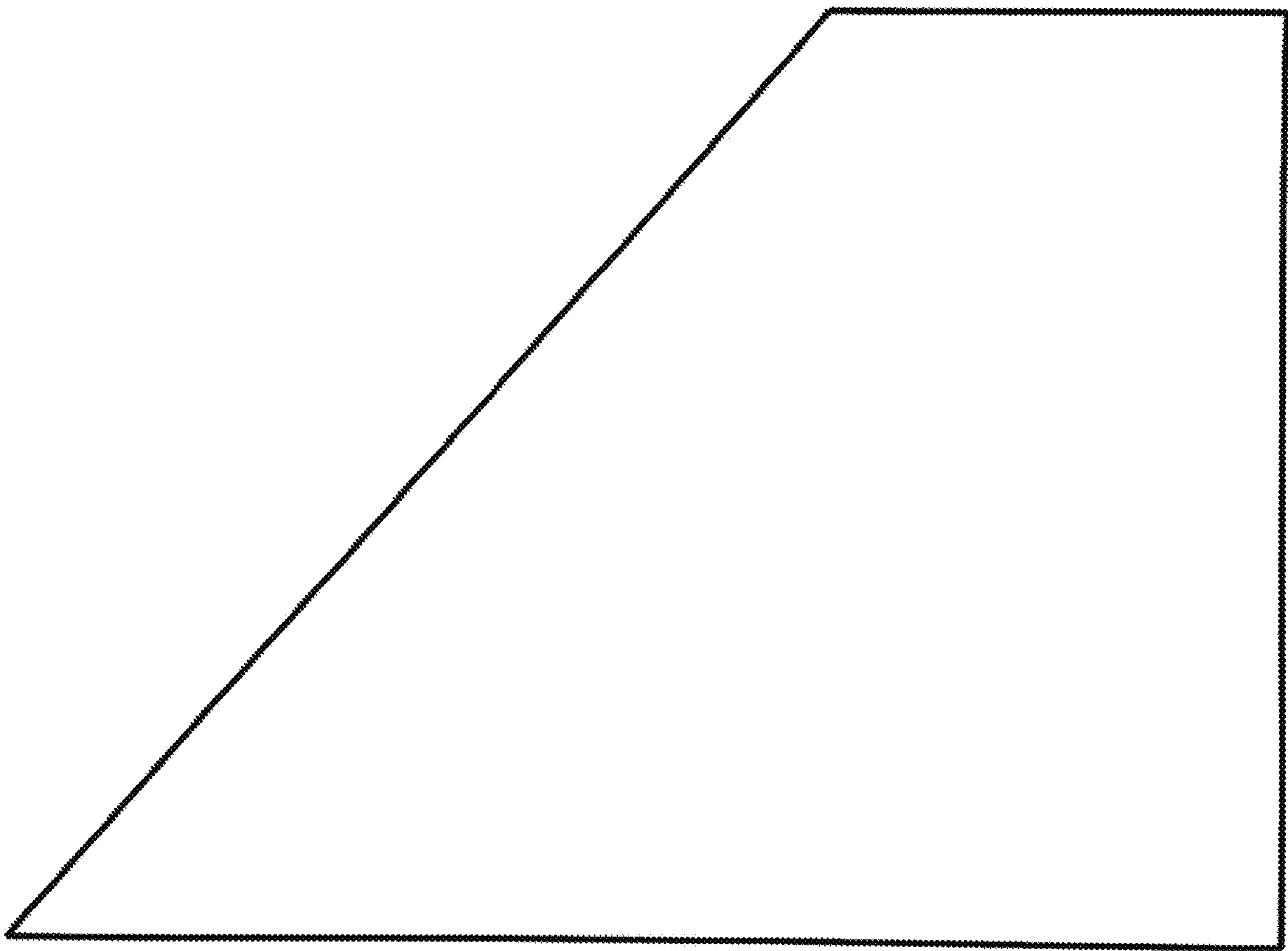

Fig. 11

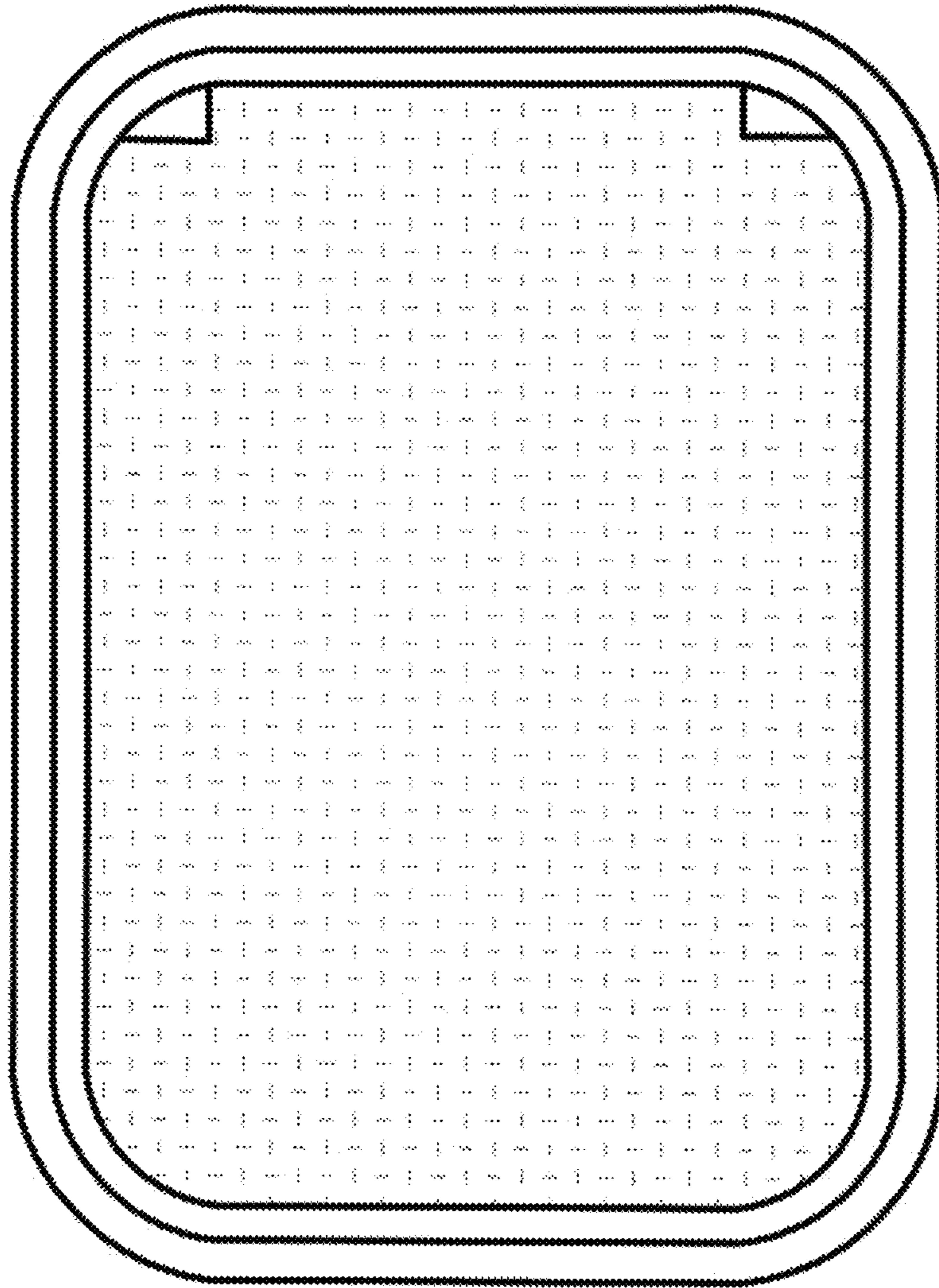

Fig. 12

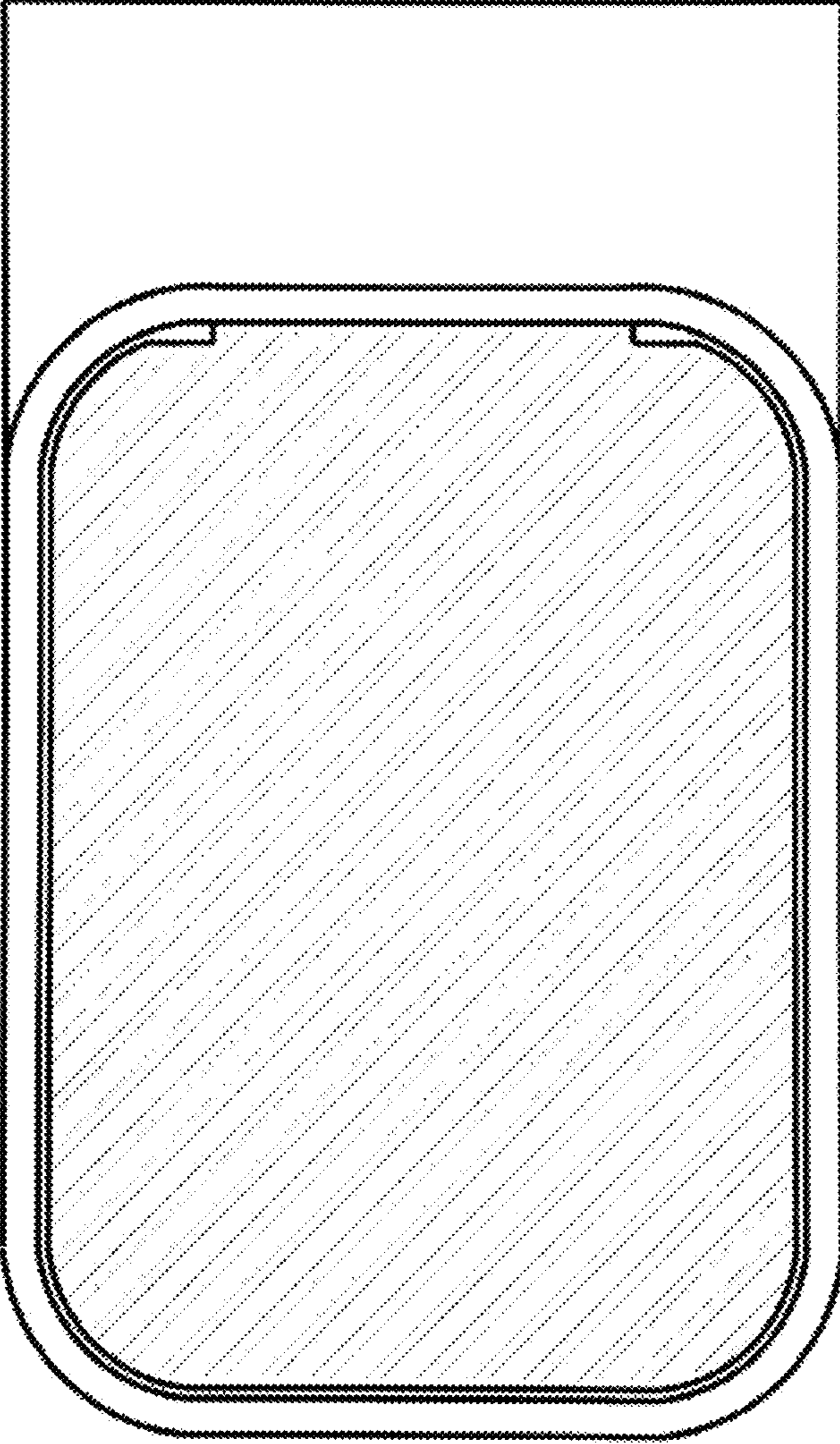
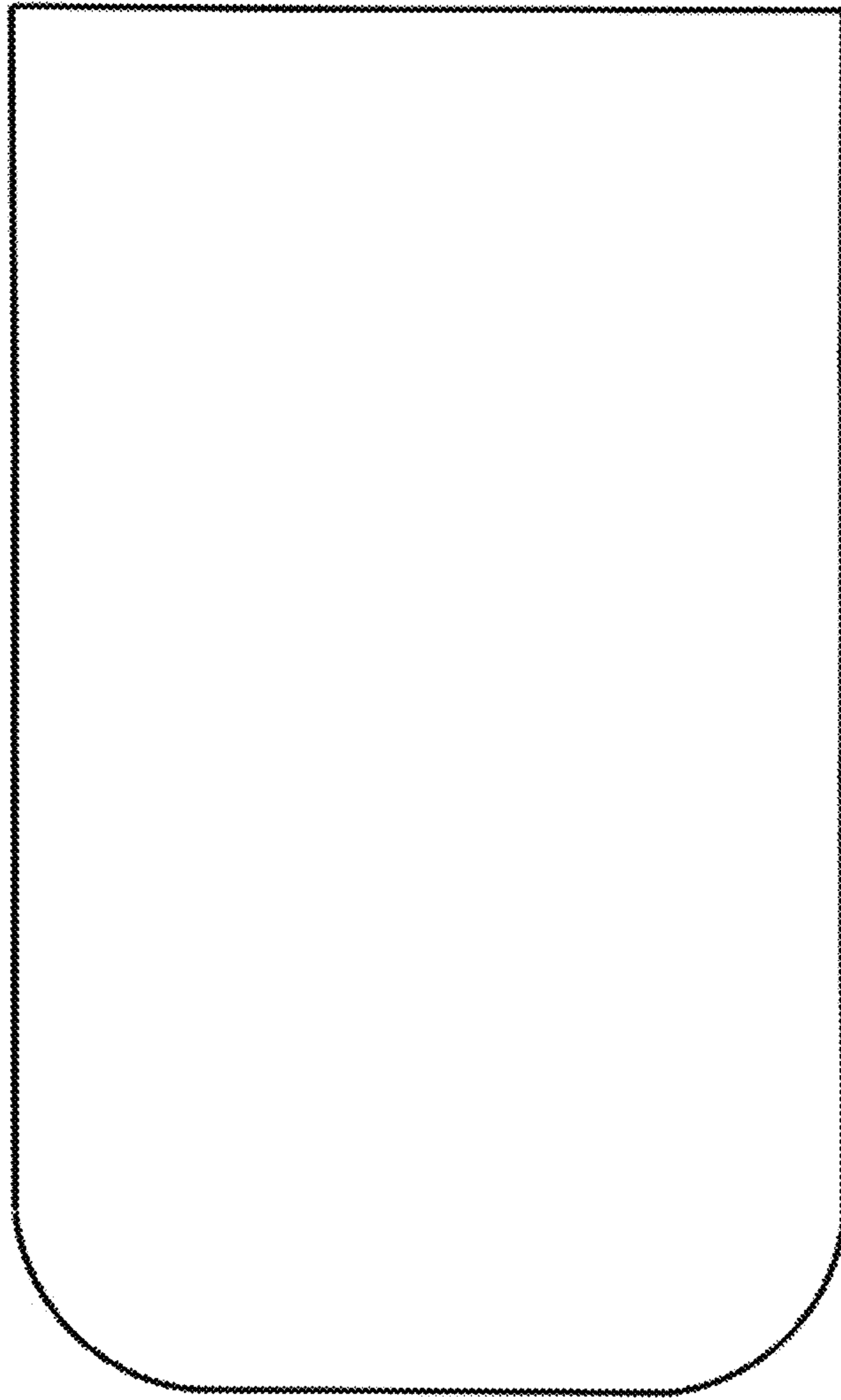

Fig. 13



**Fig. 14**



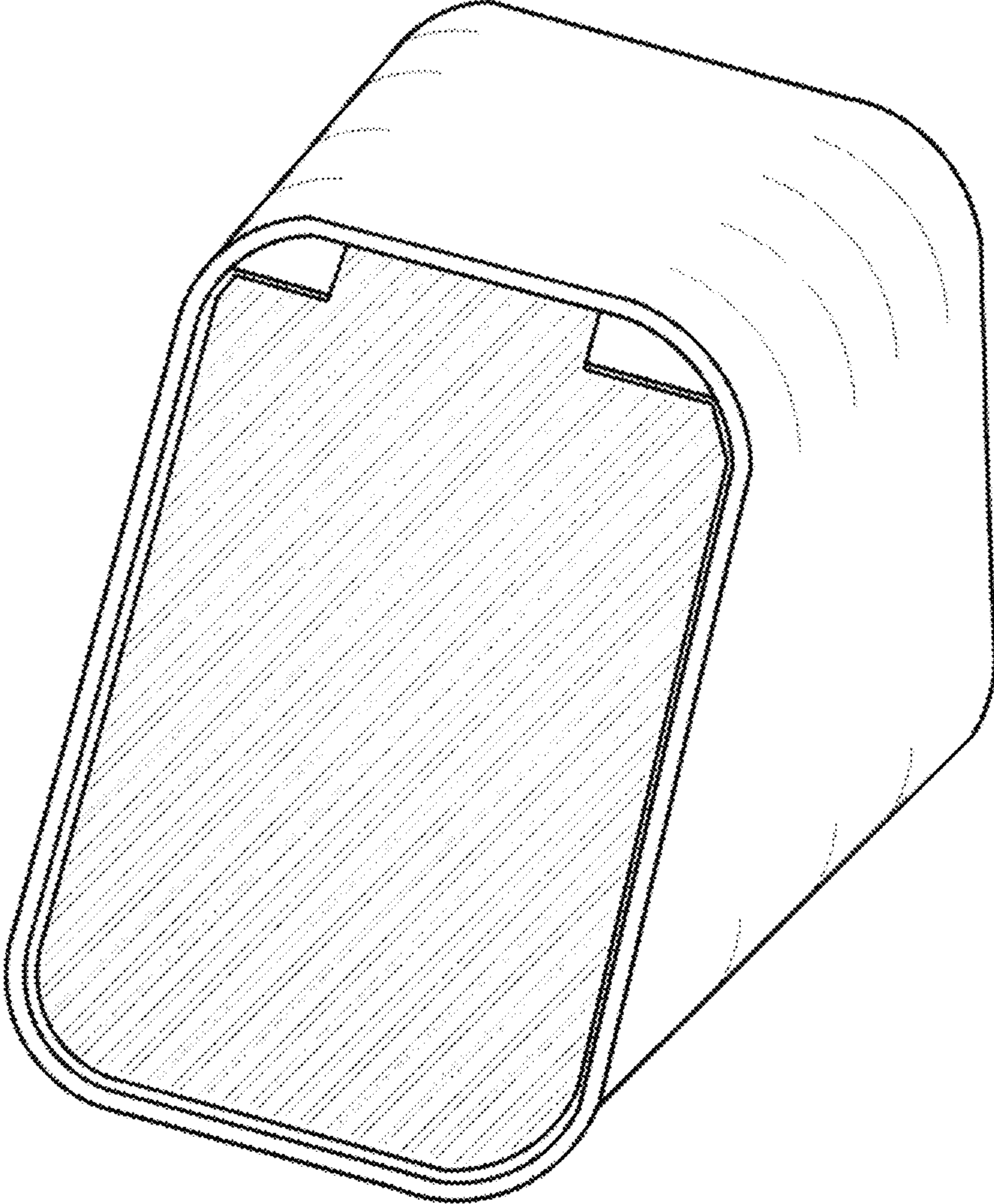

Fig. 15

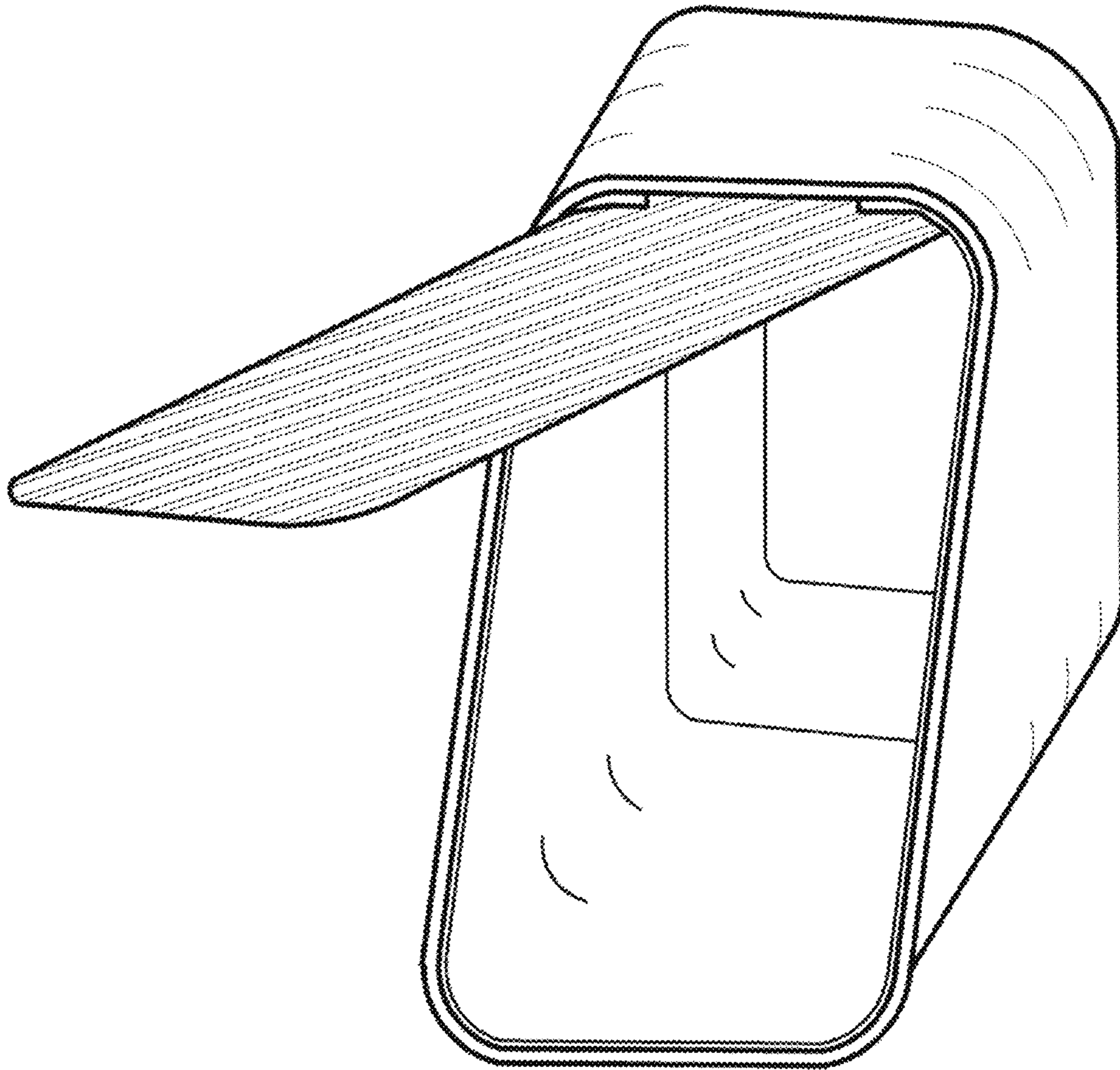

Fig. 16