



US00D882037S

(12) **United States Design Patent** (10) **Patent No.:** **US D882,037 S**
Roh et al. (45) **Date of Patent:** **** Apr. 21, 2020**

(54) **WATER PURIFIER**

B01D 2201/301; B01D 2201/302; B01D 2201/347; B01D 2201/4061; B01D 2239/0618; B01D 2239/0681; B01D 2239/083; B01D 2239/1233; B01D 2251/11; B01D

(71) Applicant: **LG ELECTRONICS INC.**, Seoul (KR)

(72) Inventors: **Hyoungwon Roh**, Seoul (KR); **Sookyung Kang**, Seoul (KR); **Najung Cho**, Seoul (KR); **Kyukwan Choi**, Seoul (KR)

(Continued)

(56)

References Cited

U.S. PATENT DOCUMENTS

(73) Assignee: **LG ELECTRONICS INC.**, Seoul (KR)

D790,898 S * 7/2017 Taubman D7/305
D795,629 S * 8/2017 Ullman D7/306

(Continued)

(**) Term: **15 Years**

Primary Examiner — Khawaja Anwar

(21) Appl. No.: **35/506,554**

(74) *Attorney, Agent, or Firm* — Birch, Stewart, Kolasch & Birch, LLP

(22) Filed: **Oct. 11, 2018**

(80) **Hague Agreement Data**

(57)

CLAIM

Int. Filing Date: **Oct. 11, 2018**
Int. Reg. No.: **DM/103608**
Int. Reg. Date: **Oct. 11, 2018**
Int. Reg. Pub. Date: **Apr. 12, 2019**

The ornamental design for a water purifier, as shown and described.

DESCRIPTION

(30) **Foreign Application Priority Data**

Apr. 23, 2018 (KR) 30-2018-0019009

(51) **LOC (12) Cl.** **23-02**

(52) **U.S. Cl.**
USPC **D23/207**

(58) **Field of Classification Search**
USPC D23/207, 209; D7/306, 309
CPC B01D 2258/06; B01D 2257/708; B01D 53/8687; B01D 2255/1021; B01D 2255/2073; B01D 2255/20761; B01D 2257/91; B01D 2259/4508; B01D 2317/02; B01D 2321/04; B01D 2321/12; B01D 46/2403; B01D 53/86; B01D 61/42; B01D 61/52; B01D 61/54; B01D 65/02; B01D 19/0031; B01D 19/0068; B01D 1/0064; B01D 2046/2433; B01D 21/0009; B01D 21/01; B01D 21/262;

- 1. Water purifier
- 1.2 : Front
- 1.3 : Back
- 1.4 : Left
- 1.5 : Top
- 1.6 : Bottom
- 1.7 : Exploded
- 1.8 : Enlarged

The broken lines depict portions of the water purifier that form no part of the claimed design; reproduction 1.1 is a front perspective view of the water purifier; reproduction 1.2 is a front view thereof; reproduction 1.3 is a back view thereof; reproduction 1.4 is a left view thereof, where the right view is a mirror image; reproduction 1.5 is a top view thereof; reproduction 1.6 is a bottom view thereof; reproduction 1.7 is an exploded view showing a state in which the water basin is separated from the main body; reproduction

(Continued)

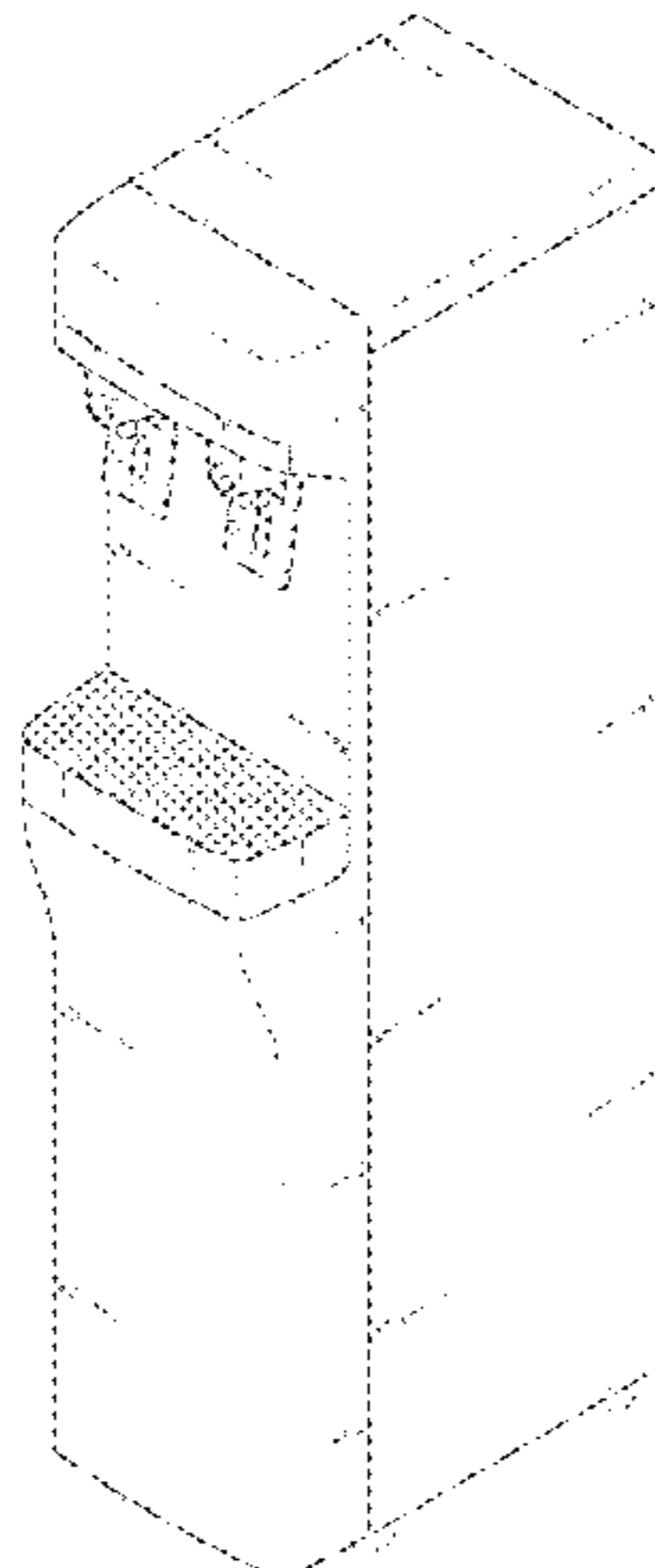

1.8 is a reference enlarged view showing the display above the water outlets is operated and forms no part of the claimed design.

1 Claim, 8 Drawing Sheets

(58) **Field of Classification Search**

CPC . 2253/102; B01D 2253/104; B01D 2253/106;
B01D 2253/108; B01D 2253/25; B01D
2253/3425; B01D 2255/1023; B01D
2255/1025; B01D 2255/104; B01D
2255/106; B01D 2255/2022; B01D
2255/2025; B01D 2255/2027; B01D
2255/2047; B01D 2255/2065; B01D
2255/207; B01D 2255/20707; B01D
2255/20715; B01D 2255/20723; B01D
2255/20738; B01D 2255/20746; B01D
2255/2092; B01D 2255/2094; B01D
2255/30; B01D 2255/40; B01D 2255/50;
B01D 2255/70; B01D 2255/802; B01D
2255/9155; B01D 2255/9207; B01D
2256/16; B01D 2257/2064; B01D
2257/30; B01D 2257/306; B01D
2257/402; B01D 2257/502; B01D
2257/504; B01D 2257/93; B01D
2259/4566; B01D 2259/4575; B01D
2259/802; B01D 2259/818; B01D
2273/30; B01D 2275/10; B01D 2313/22;
B01D 2313/24; B01D 2313/40; B01D

2325/34; B01D 2325/42; B01D 29/15;
B01D 29/60; B01D 35/147; B01D
35/157; B01D 35/30; B01D 35/306;
B01D 36/00; B01D 37/04; B01D 39/163;
B01D 3/145; B01D 45/14; B01D
46/0086; B01D 46/2429; B01D 46/2455;
B01D 46/42; B01D 46/444; B01D
46/446; B01D 53/007; B01D 53/0407;
B01D 53/047; B01D 53/261; B01D
53/32; B01D 53/346; B01D 53/8668;
B01D 53/8675; B01D 5/0072; B01D
61/08; B01D 61/18; B01D 61/22; B01D
61/364; B01D 61/366; B01D 61/368;
B01D 63/02; B01D 63/06; B01D 63/14;
B01D 69/10; B01D 69/12; B01D 71/32;
B01D 71/82

See application file for complete search history.

(56)

References Cited

U.S. PATENT DOCUMENTS

D799,255 S * 10/2017 Ullman D7/306
D805,601 S * 12/2017 Roh D23/207
D813,346 S * 3/2018 Lee D23/207
D832,021 S * 10/2018 Yoon D7/313
D842,428 S * 3/2019 Choi D23/207
D842,966 S * 3/2019 Shin D23/207
D855,151 S * 7/2019 Joo D23/207
D868,522 S * 12/2019 Jeon D7/313
2017/0057802 A1 * 3/2017 Lee B67D 1/0085

* cited by examiner

1.1

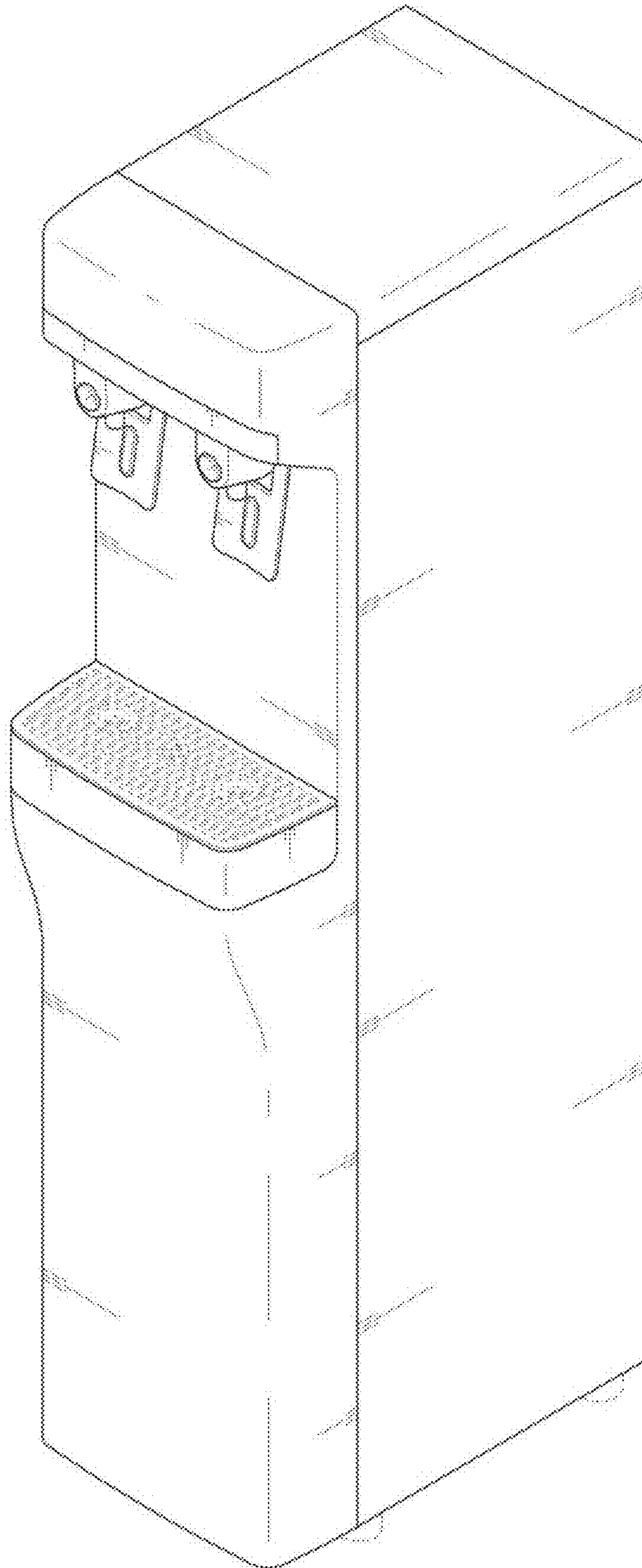

1.2

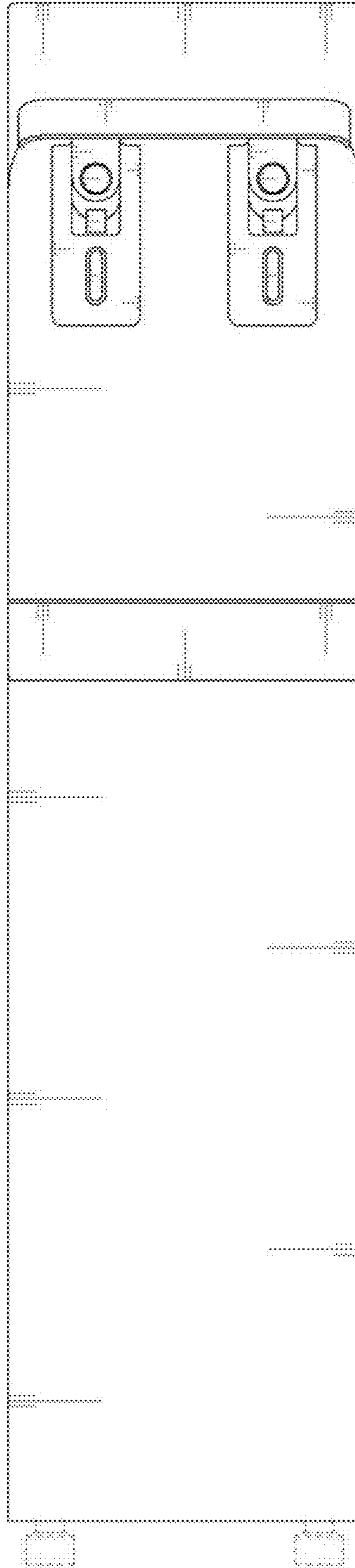

1.3

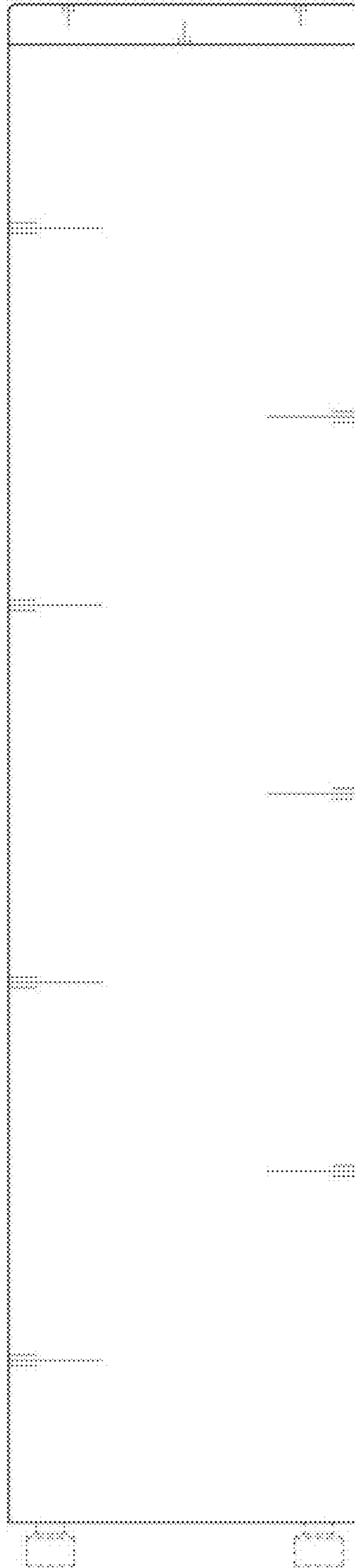

1.4

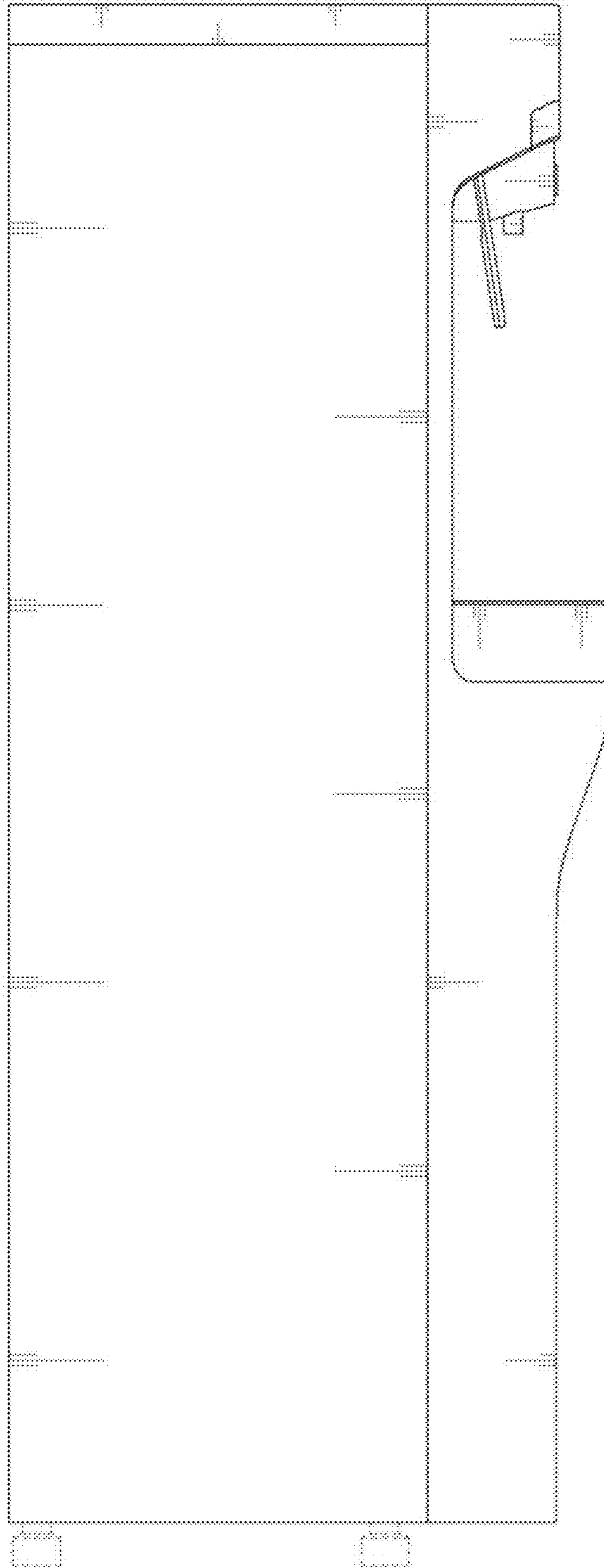

1.5

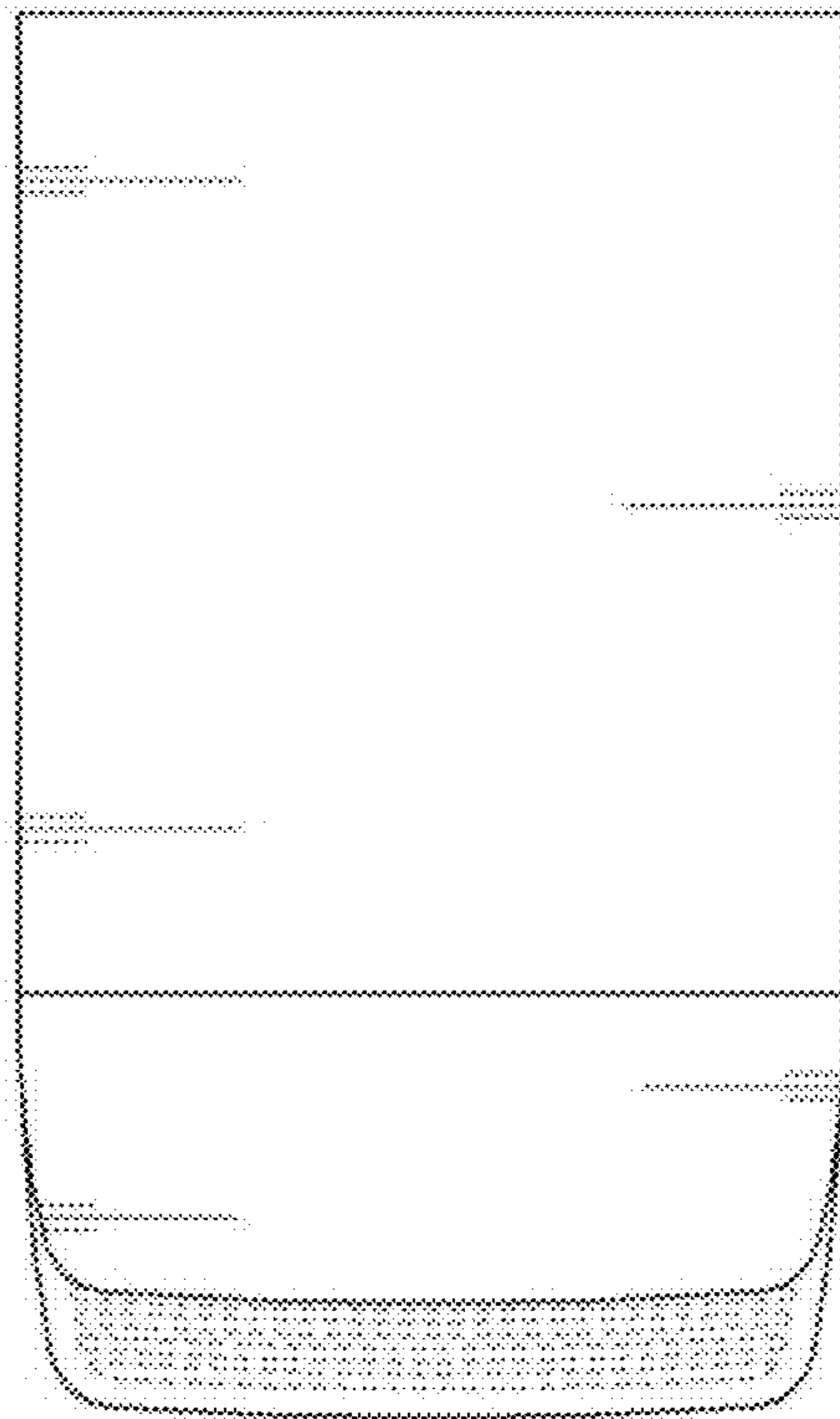

1.6

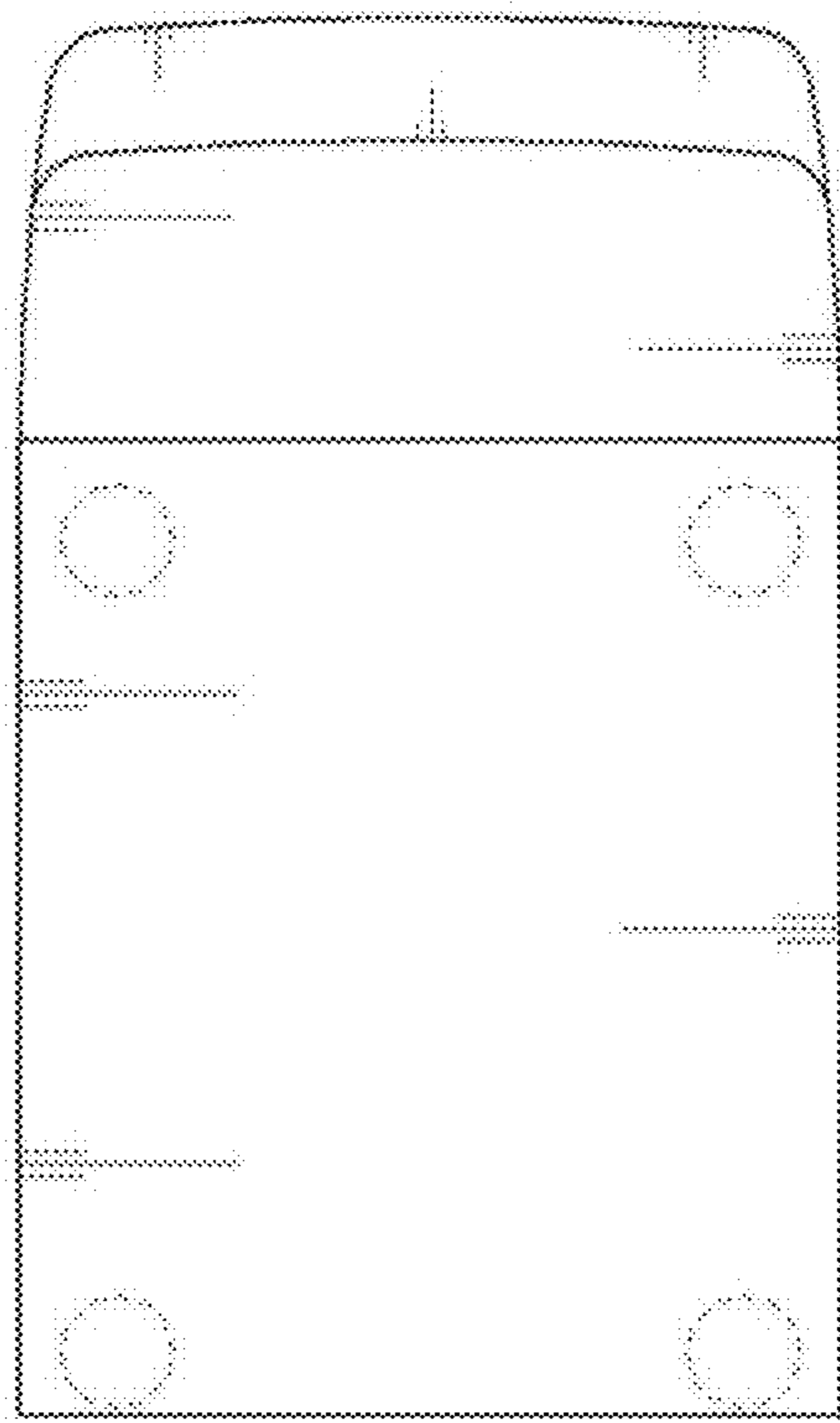

1.7

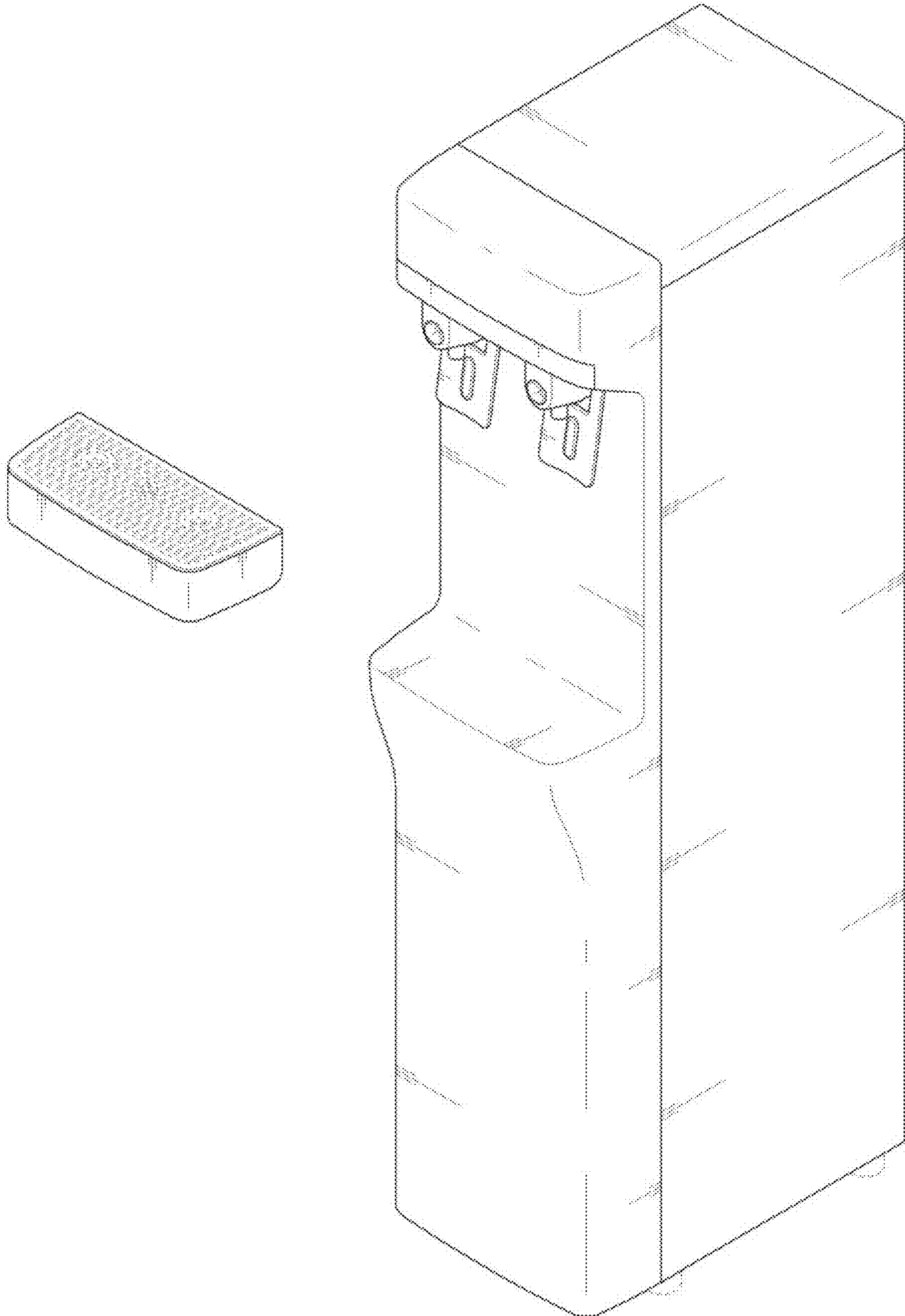

1.8

