



US00D882034S

(12) **United States Design Patent**
Powell et al.

(10) **Patent No.:** **US D882,034 S**
(45) **Date of Patent:** **** Apr. 21, 2020**

- (54) **TURKEY DECOY**
- (71) Applicant: **BUSHNELL HOLDINGS, INC.**,
Overland Park, KS (US)
- (72) Inventors: **Michael E. Powell**, Madison, MS (US);
Herbert J. Harris, Brandon, MS (US);
Garrett T. Grey, Brandon, MS (US)
- (73) Assignee: **BUSHNELL HOLDINGS, INC.**,
Overland Park, KS (US)
- (**) Term: **15 Years**
- (21) Appl. No.: **29/674,815**
- (22) Filed: **Dec. 26, 2018**
- (51) **LOC (12) Cl.** **22-05**
- (52) **U.S. Cl.**
USPC **D22/125**
- (58) **Field of Classification Search**
USPC D22/125, 199; 43/2, 3; 119/713;
D3/1-4; 428/542.4, 16, 913.3; 434/296
CPC A01M 31/06; B44C 5/02
See application file for complete search history.

- 7,231,737 B2 * 6/2007 Bradford A01M 31/06
43/2
- D557,371 S * 12/2007 Wyant D22/125
- D560,745 S * 1/2008 Bulger D22/125
- D560,746 S * 1/2008 Bulger D22/125
- 8,323,756 B2 * 12/2012 Peterson B44C 5/02
428/16
- D849,879 S * 5/2019 Embury D22/125
- 2005/0081422 A1 * 4/2005 Bradford A01M 31/06
43/2

* cited by examiner

Primary Examiner — Catherine R Oliver-Garcia
(74) *Attorney, Agent, or Firm* — Richard A. Graham;
Gerard M. Donovan; Reed Smith LLP

(57) **CLAIM**

The ornamental design for a turkey decoy, as shown and described.

DESCRIPTION

FIG. 1 is a perspective view of a turkey decoy;
FIG. 2 is a front elevation view thereof;
FIG. 3 is a rear elevation view thereof;
FIG. 4 is a top plan view thereof;
FIG. 5 is a bottom plan view thereof;
FIG. 6 is a right side elevation view thereof; and,
FIG. 7 is a left side elevation view thereof.
The broken lines depict environmental structure and are included for the purpose of illustration only and form no part of the claimed design.

(56) **References Cited**

U.S. PATENT DOCUMENTS

- D24,903 S * 11/1895 Elmore D3/3
- 4,590,699 A * 5/1986 Nicks A01M 31/06
43/2

1 Claim, 6 Drawing Sheets

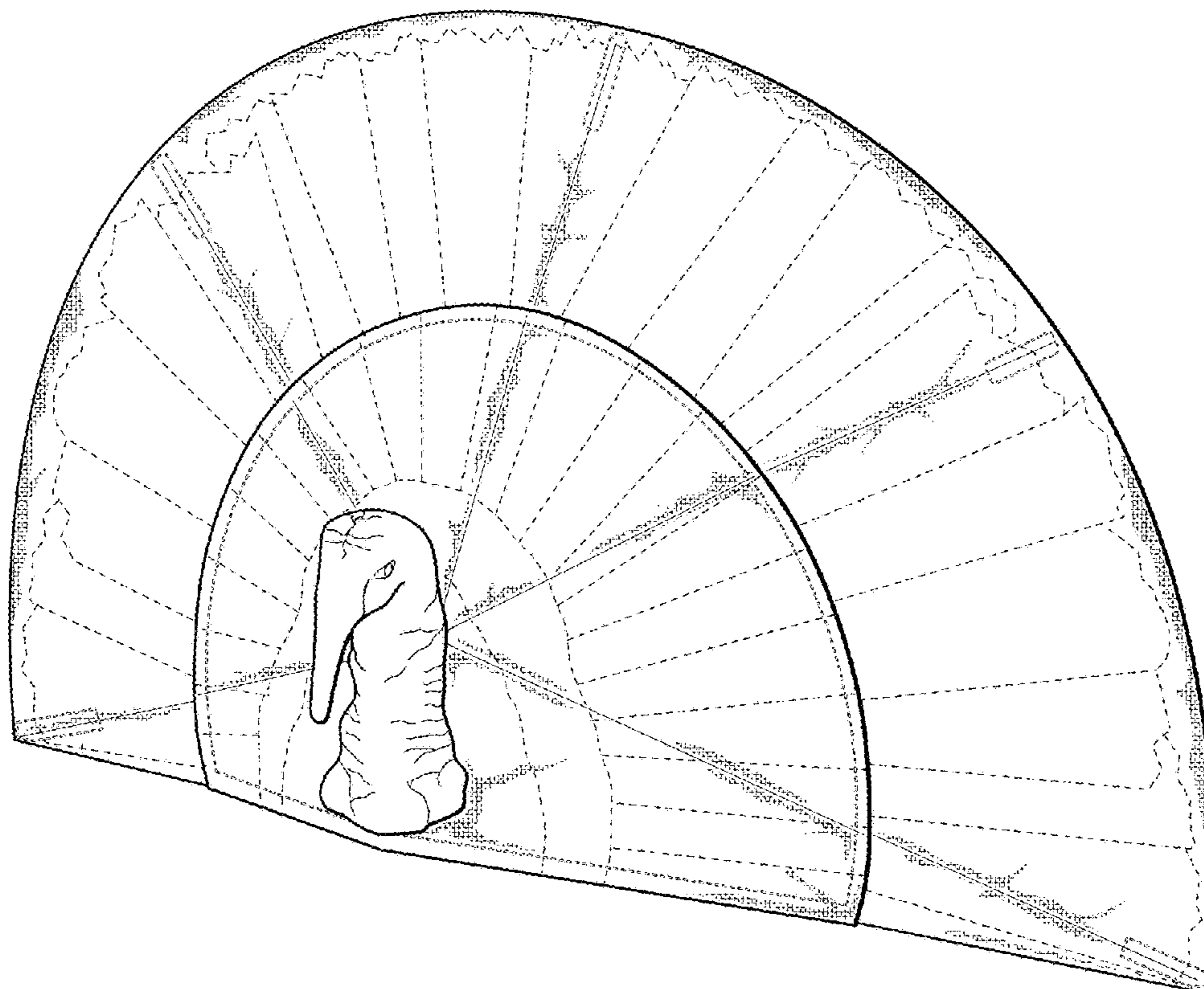

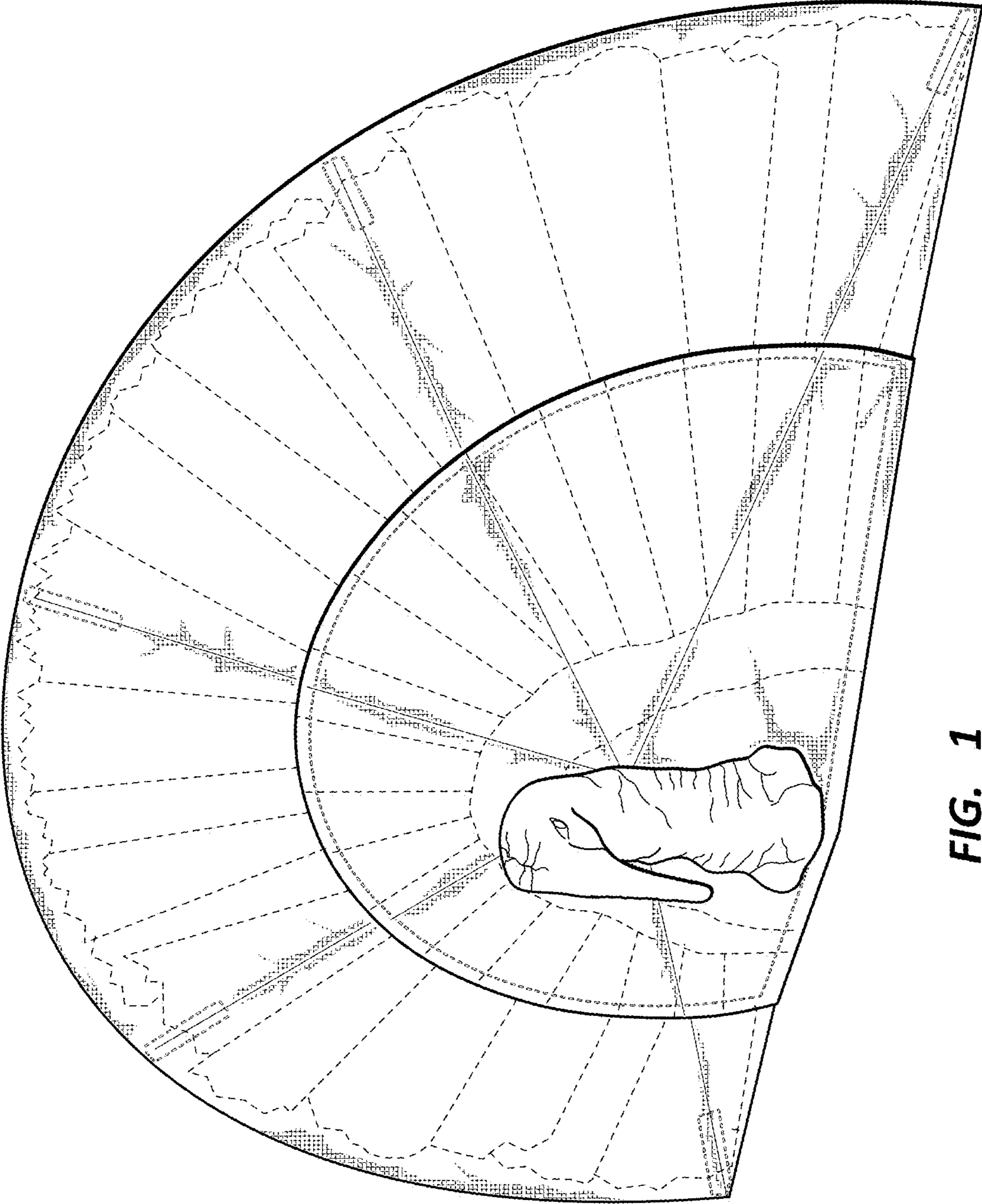

FIG. 1

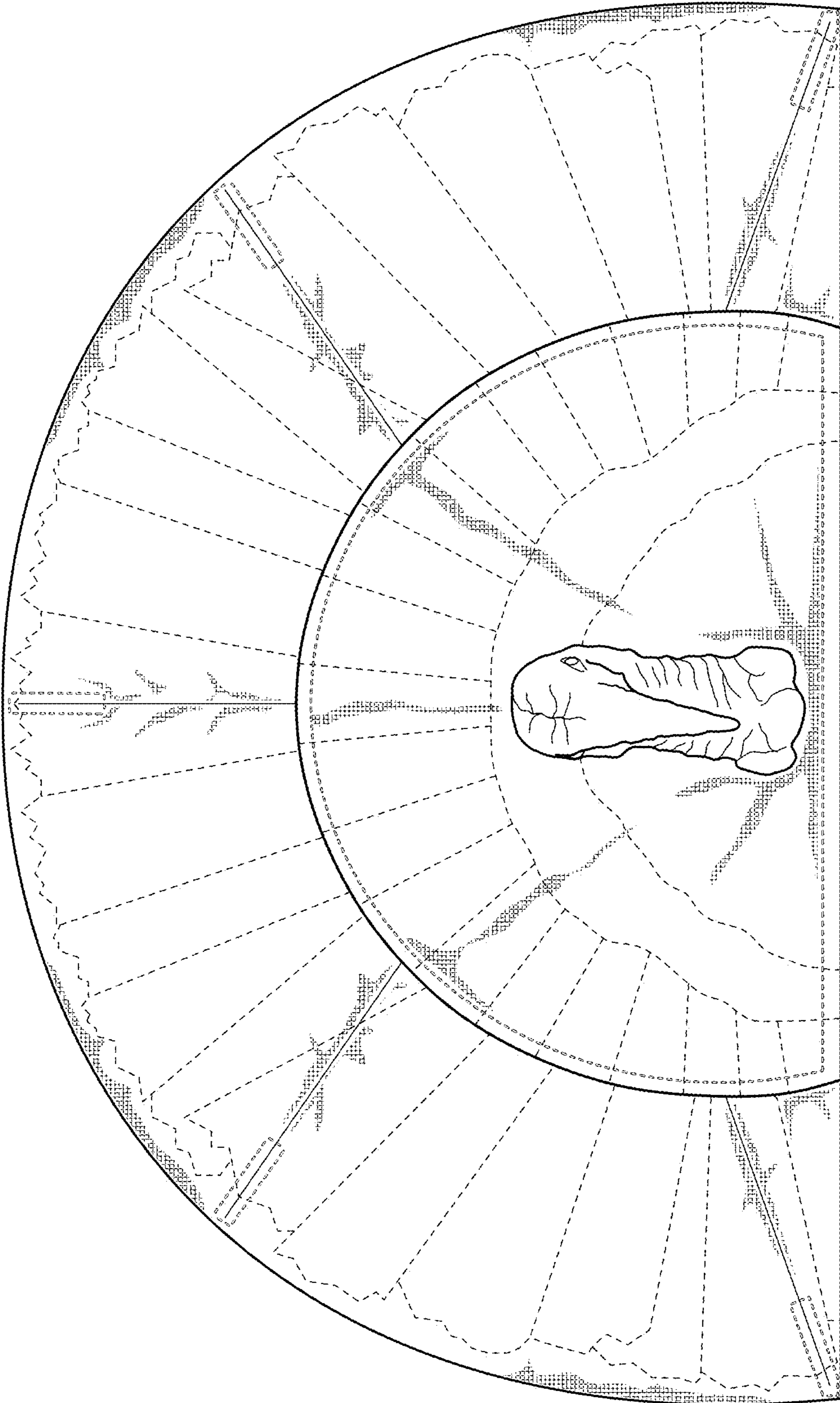

FIG. 2

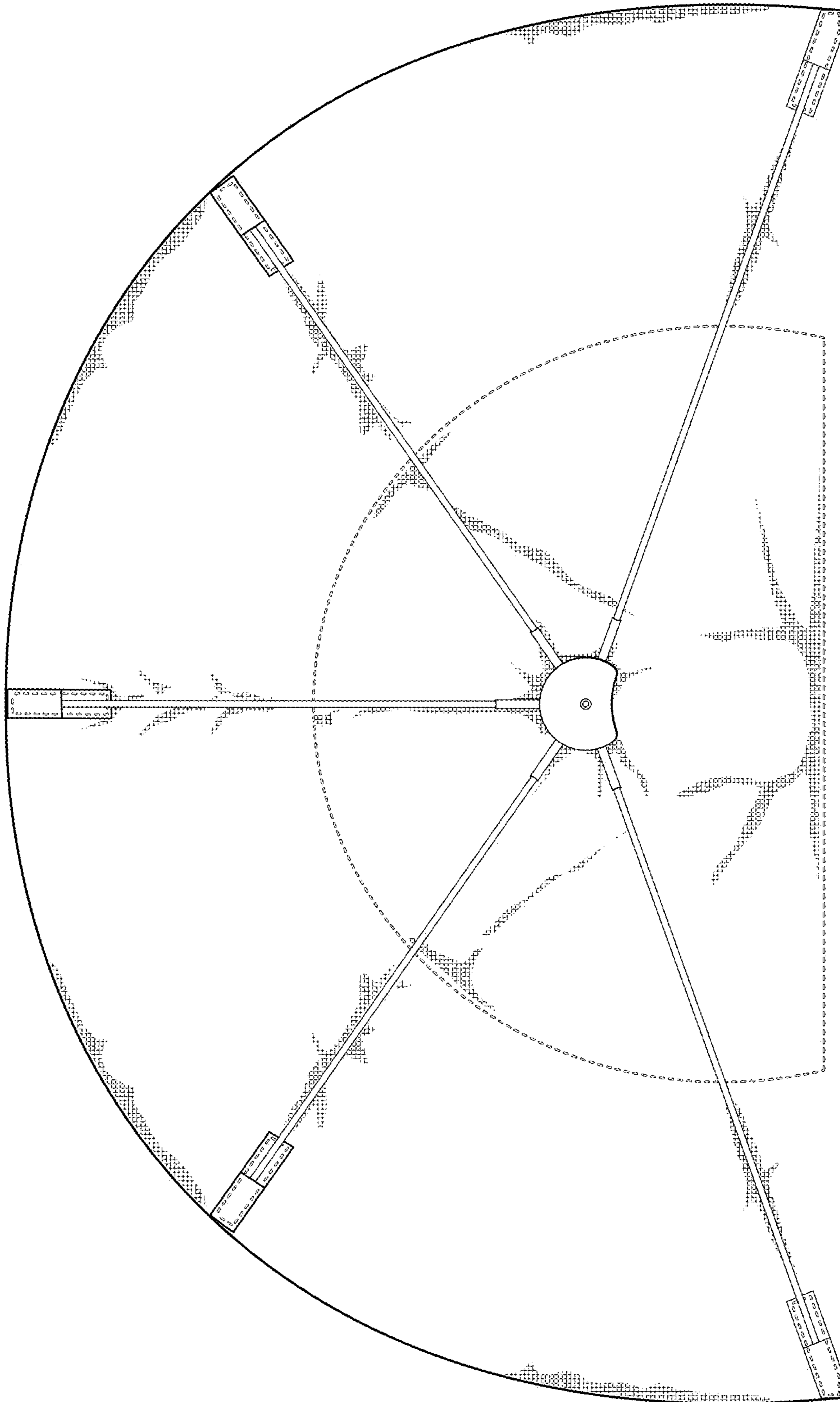

FIG. 3

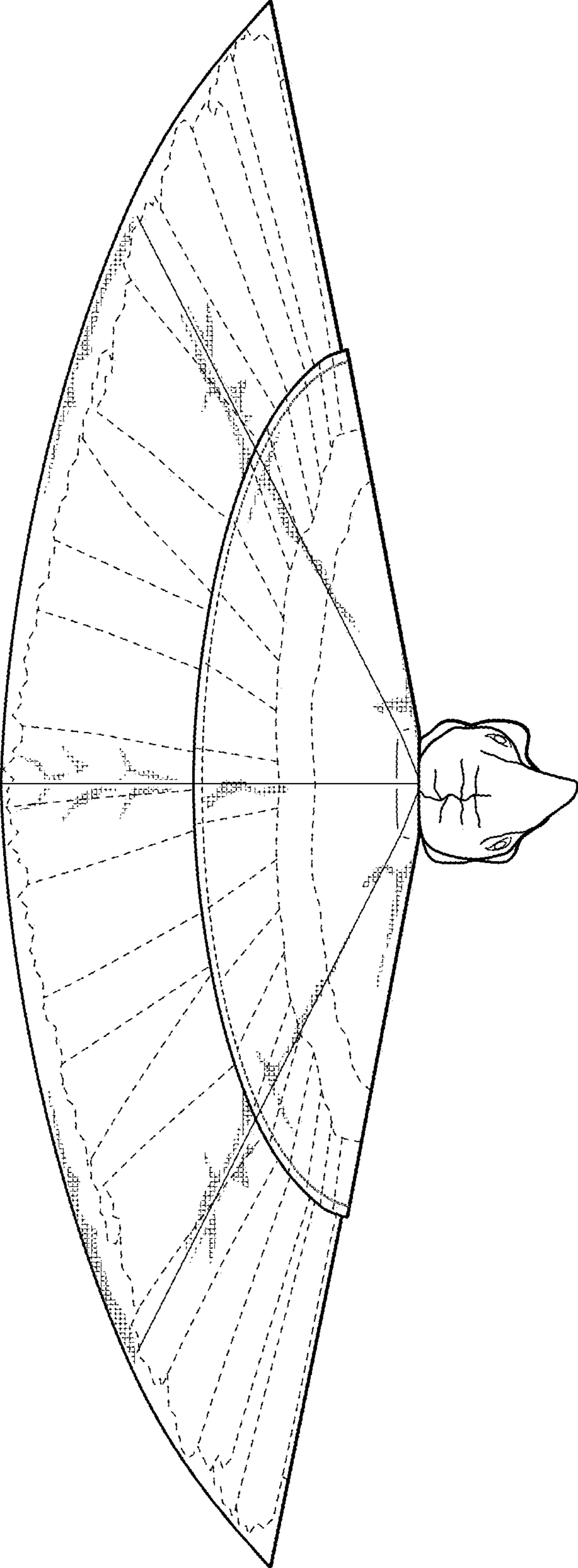

FIG. 4

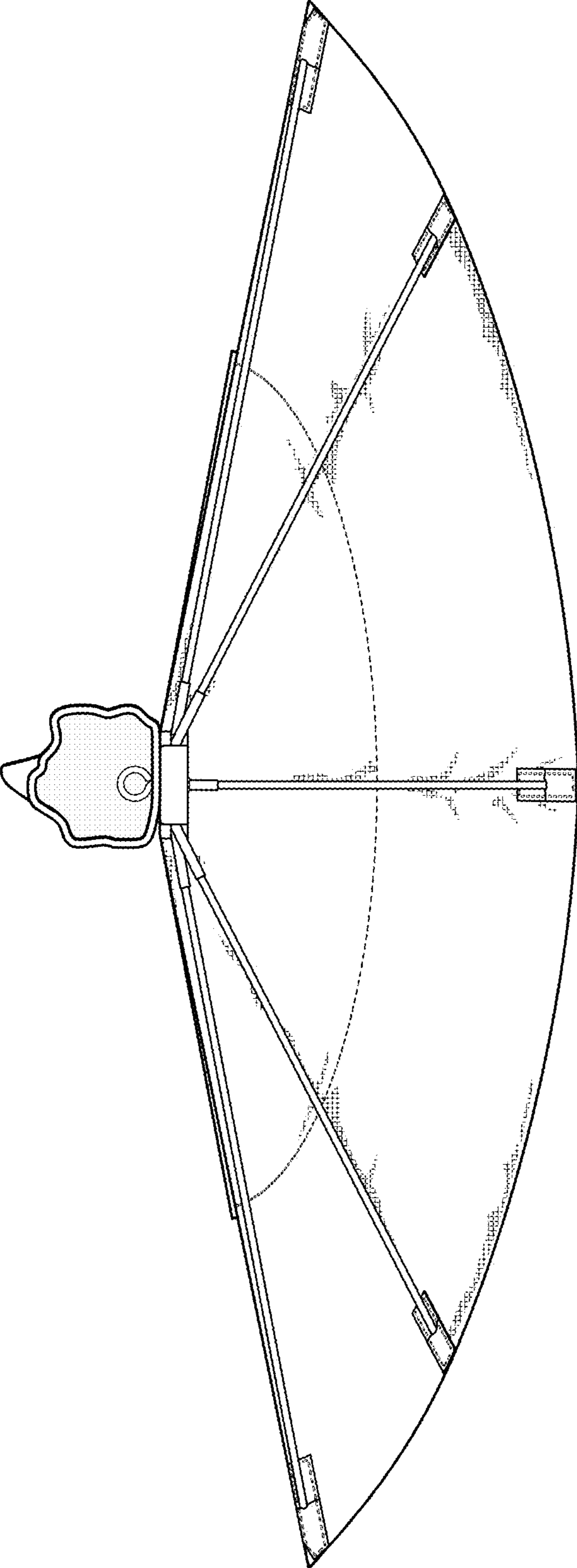

FIG. 5

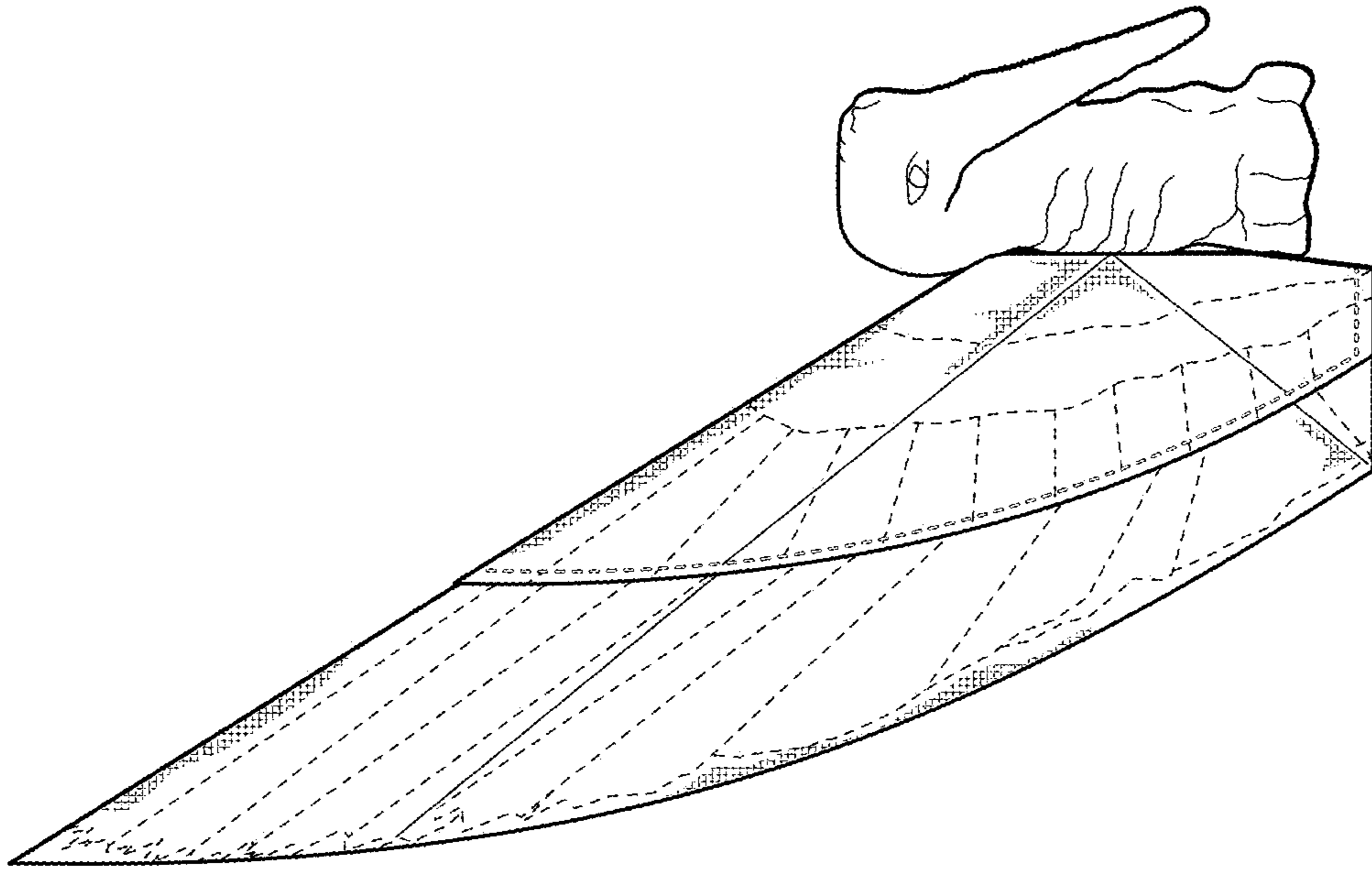

FIG. 7

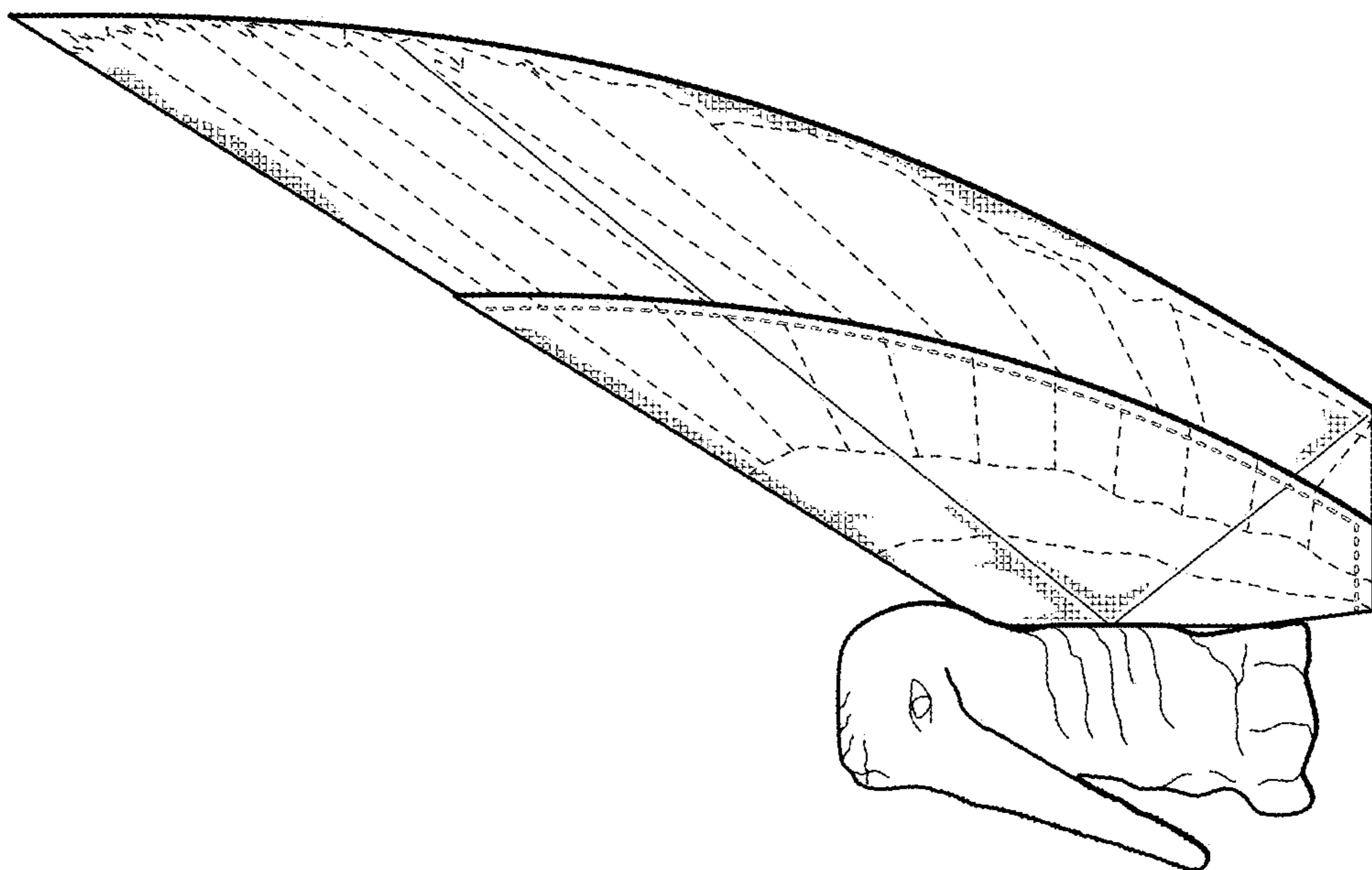

FIG. 6