



US00D881953S

(12) **United States Design Patent**  
**Kim et al.**

(10) **Patent No.:** **US D881,953 S**

(45) **Date of Patent:** **\*\* Apr. 21, 2020**

(54) **REFRIGERATOR**

(71) Applicant: **SAMSUNG ELECTRONICS CO., LTD.**, Suwon-si, Gyeonggi-do (KR)

(72) Inventors: **Jeongmin Kim**, Seoul (KR);  
**Choongeun Lee**, Seoul (KR)

(73) Assignee: **SAMSUNG ELECTRONICS CO., LTD.**, Gyeonggi-Do (KR)

(\*\*) Term: **15 Years**

(21) Appl. No.: **29/672,825**

(22) Filed: **Dec. 10, 2018**

(30) **Foreign Application Priority Data**

Jun. 19, 2018 (KR) ..... 30-2018-0028185

(51) **LOC (12) Cl.** ..... **15-07**

(52) **U.S. Cl.**  
USPC ..... **D15/81**

(58) **Field of Classification Search**  
USPC ..... D15/79-91

CPC ..... F02M 37/18; F02M 3/045; F02M 43/00;  
F02M 51/04; F02M 51/0614; F02M  
53/043; F02M 55/004; F02M 55/008;  
F02M 57/021; F02M 57/027; F02M  
59/025; F02M 59/10; F02M 5/00; F02M  
5/12; F02M 5/14; F02M 61/02; F02M  
61/045; F02M 61/14; F02M 61/145;  
F02M 61/18; F02M 61/184; F02M  
61/1853; F02M 61/20; F02M 65/003;  
F02M 69/00; F02M 69/041; F02M  
69/043; F02M 69/32; F02M 69/50; F02M  
7/10; F02M 7/12; F02M 7/133; F02M  
7/17; F02M 9/12; F02M 9/127; F02M  
9/14

See application file for complete search history.

(56) **References Cited**

U.S. PATENT DOCUMENTS

D713,426 S \* 9/2014 Sood ..... D15/81  
D768,734 S \* 10/2016 Seo ..... D15/86

D773,539 S \* 12/2016 Kim ..... D15/86  
D775,674 S \* 1/2017 Seo ..... D15/86  
D776,171 S \* 1/2017 Wang ..... D15/88  
D788,185 S \* 5/2017 Wolfe ..... D15/79  
D803,903 S \* 11/2017 Wang ..... D15/88  
D832,311 S \* 10/2018 Twigg, III ..... D15/79  
D839,930 S \* 2/2019 Fischbach ..... D15/79  
D846,600 S \* 4/2019 Guo ..... D15/81  
D847,214 S \* 4/2019 Guo ..... D15/81  
D863,377 S \* 10/2019 Saunders ..... D15/79  
D866,619 S \* 11/2019 De Clercq ..... D15/79

FOREIGN PATENT DOCUMENTS

CN 303208048 S 5/2015  
CN 303248812 S 6/2015  
CN 303288520 S 7/2015  
KR 300316778 S 2/2003  
KR 300320806 S 3/2003

\* cited by examiner

*Primary Examiner* — Khawaja Anwar

(74) *Attorney, Agent, or Firm* — Cantor Colburn LLP

(57) **CLAIM**

The ornamental design for a refrigerator, as shown and described.

**DESCRIPTION**

FIG. 1 is a front perspective view of a refrigerator, showing our new design;

FIG. 2 is a front view thereof;

FIG. 3 is a rear view thereof;

FIG. 4 is a left-side view thereof;

FIG. 5 is a right-side view thereof;

FIG. 6 is a top view thereof; and

FIG. 7 is a bottom view thereof; and,

FIG. 8 is another front perspective view thereof.

The broken lines illustrating portions of the refrigerator form no part of the claimed design.

**1 Claim, 8 Drawing Sheets**

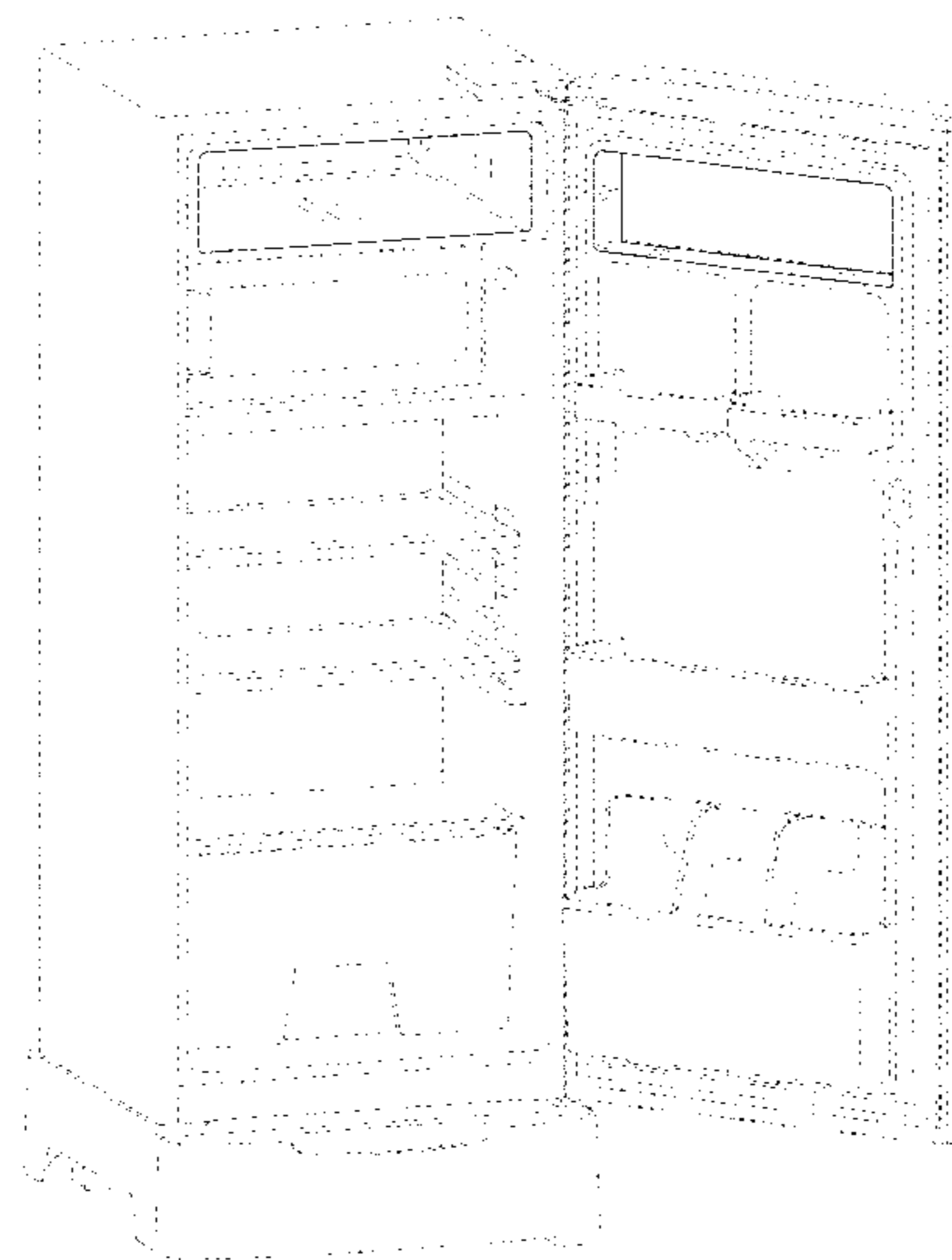

FIG. 1

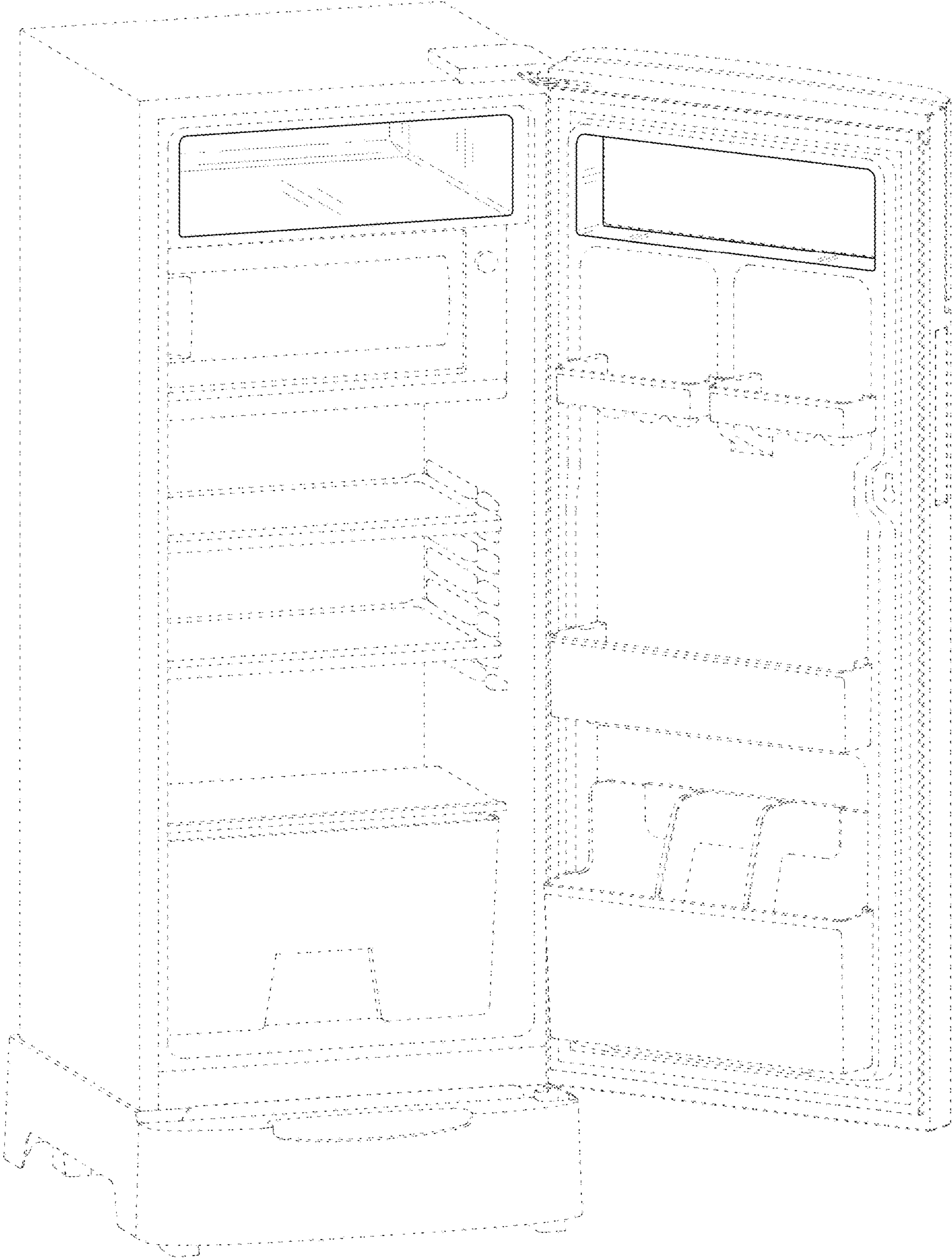

FIG. 2

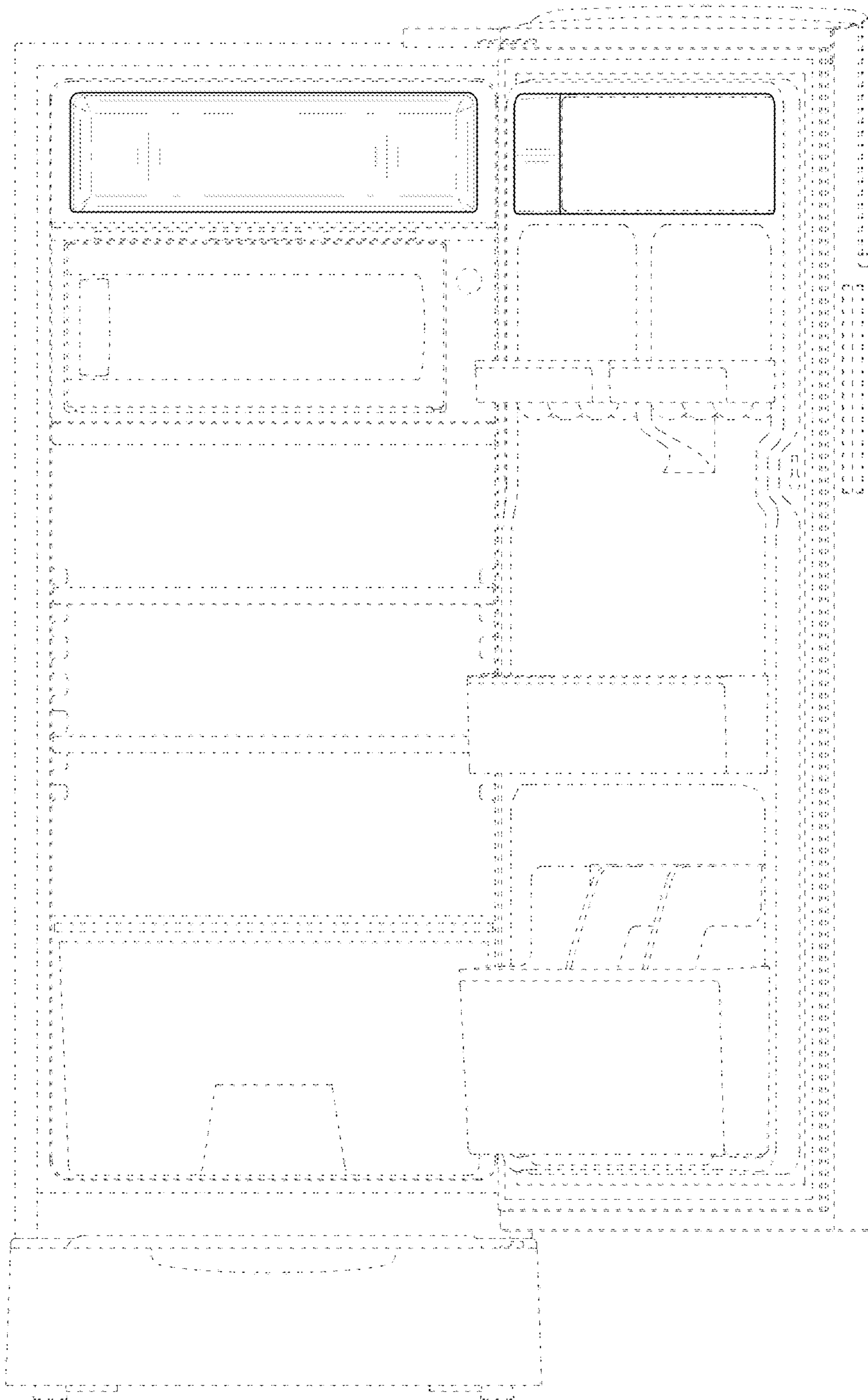

FIG. 3

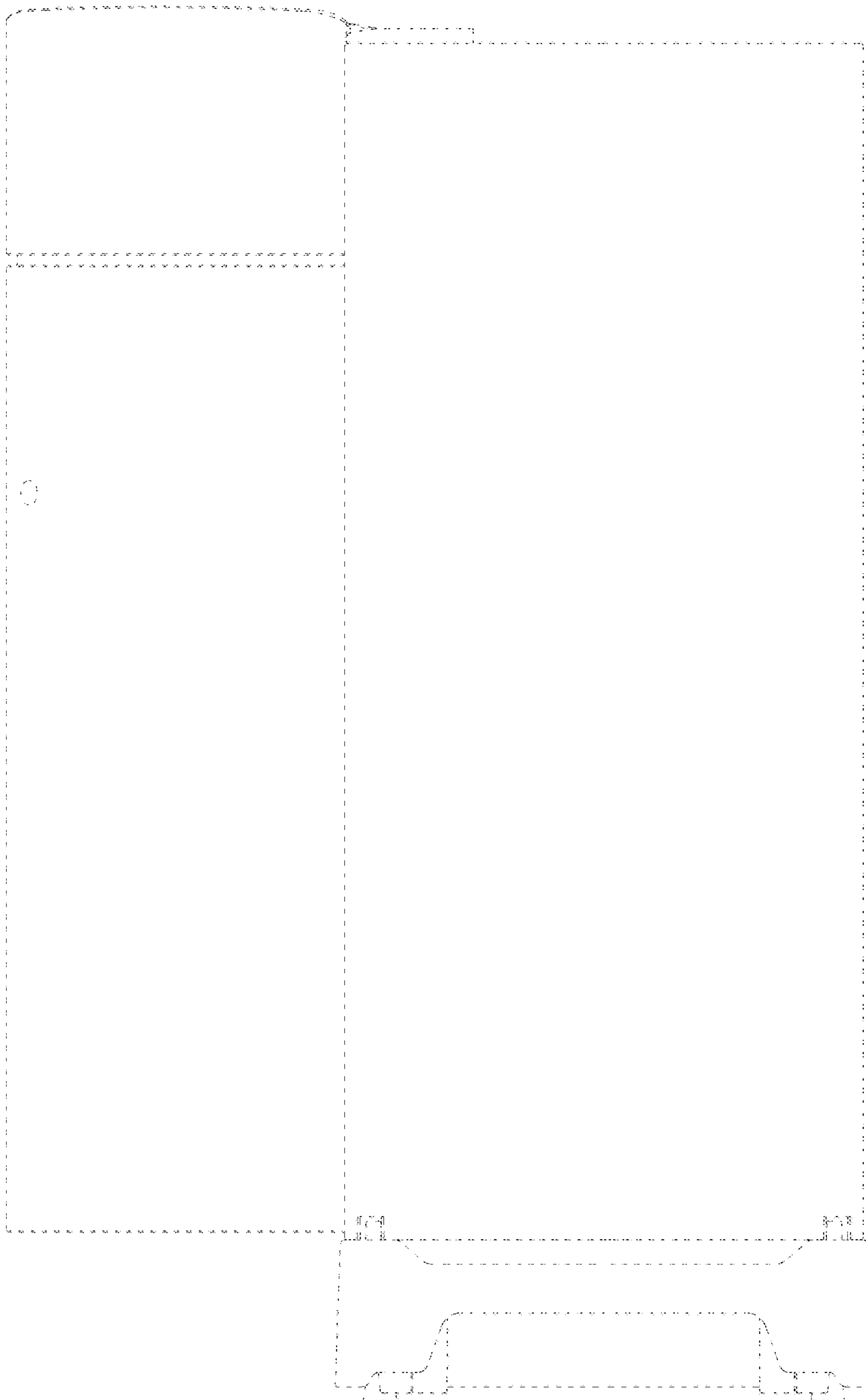

FIG. 4

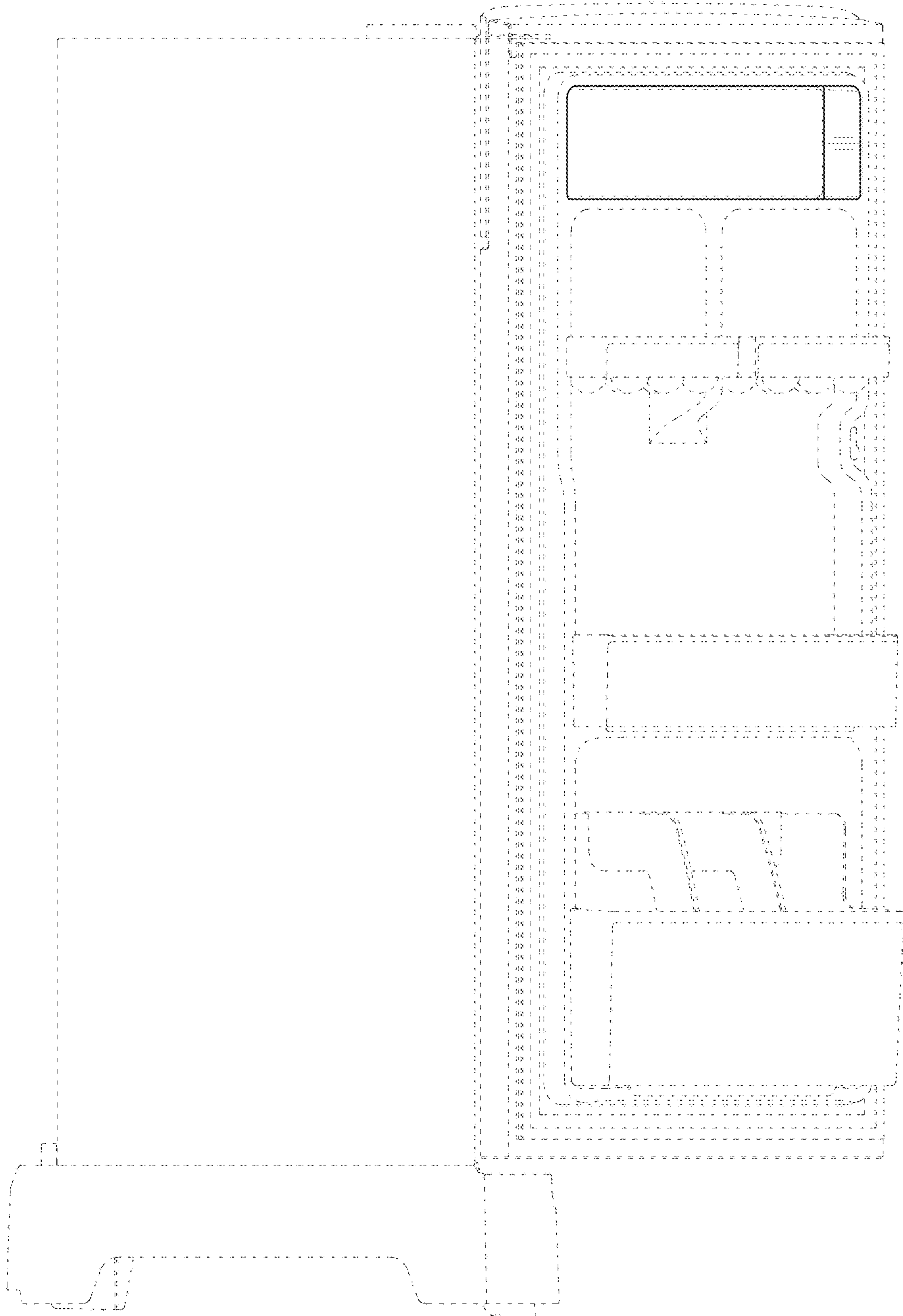

FIG. 5

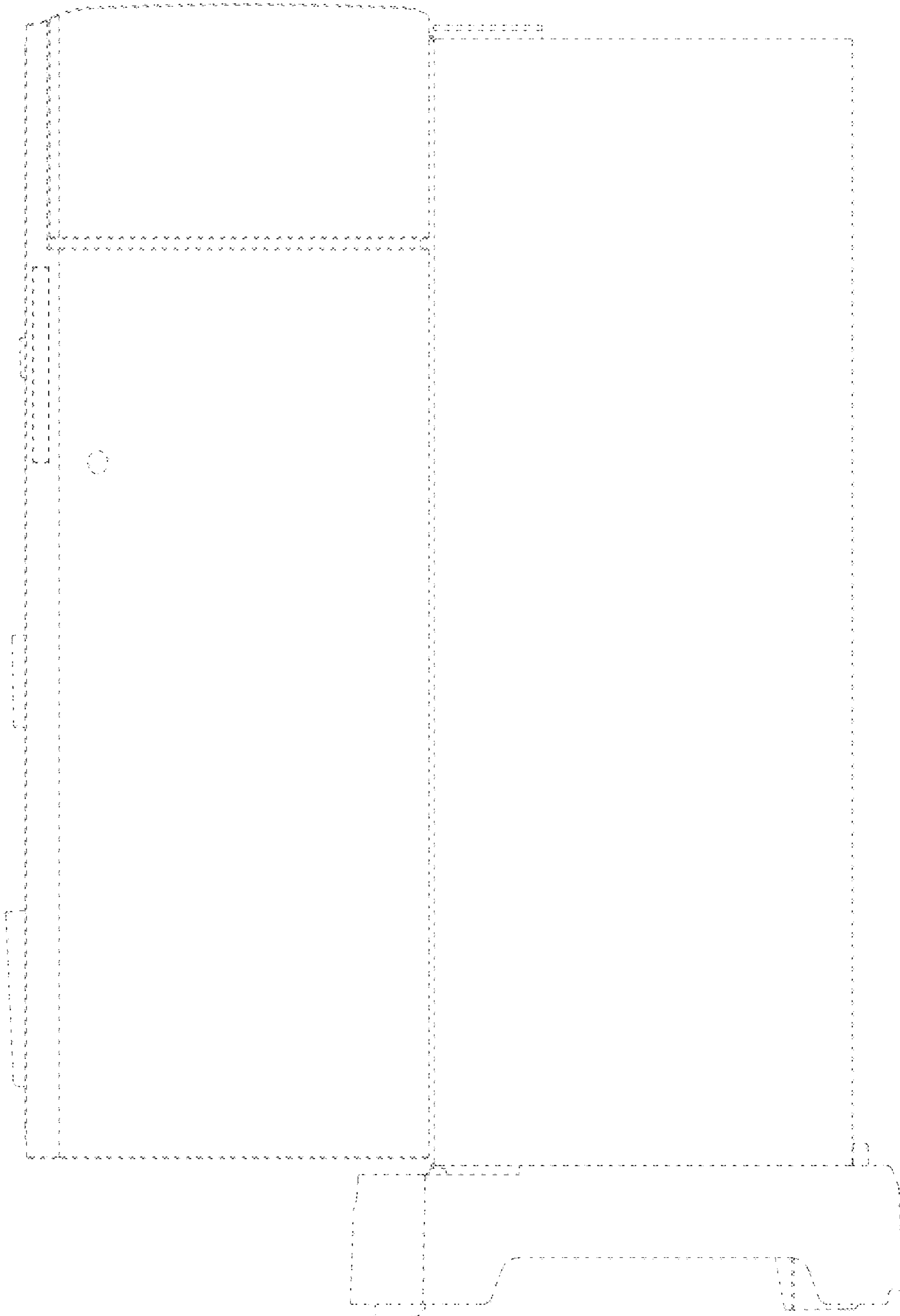

FIG. 6

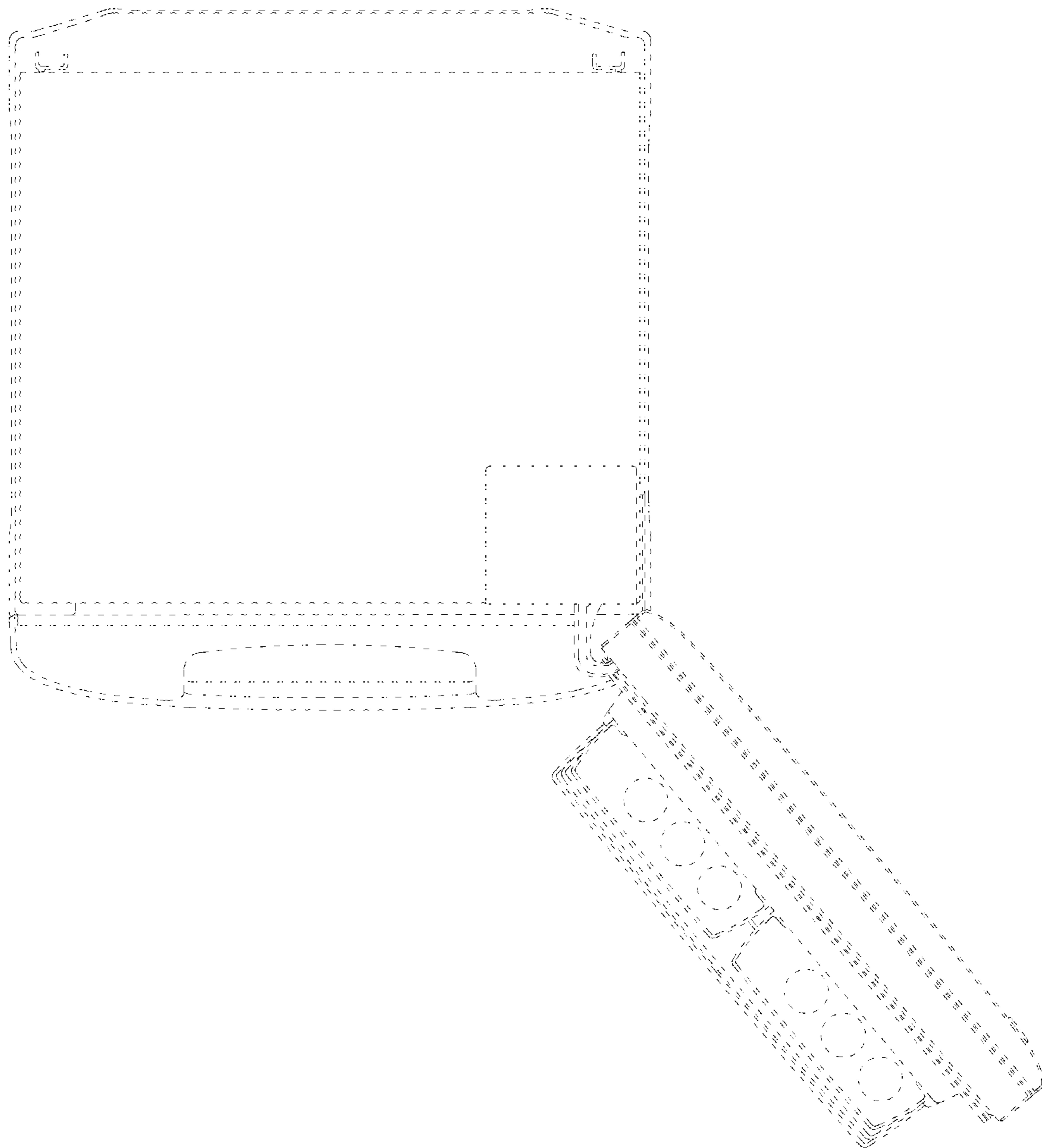

FIG. 7

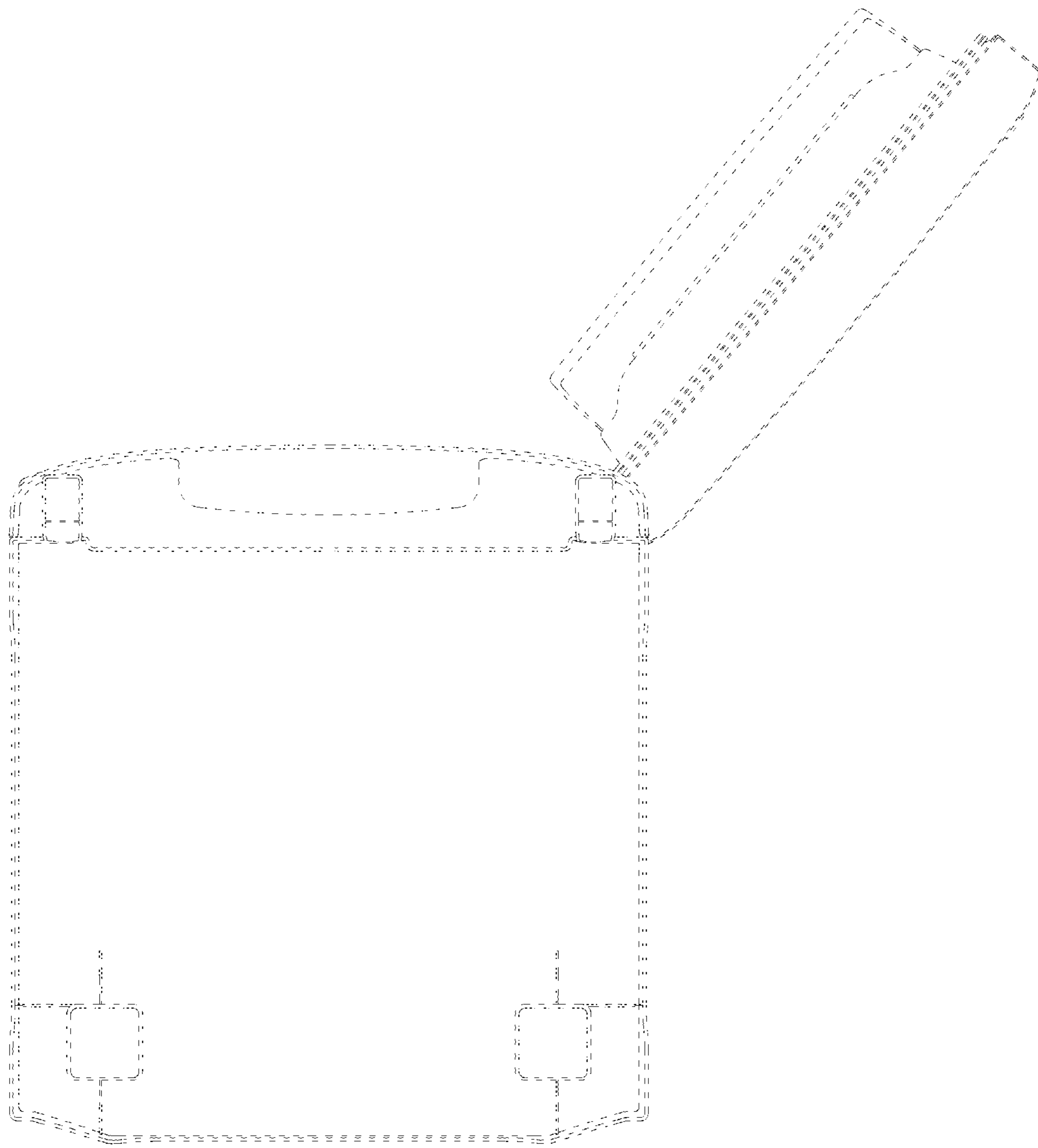



FIG. 8

