



US00D881714S

(12) **United States Design Patent**
Moretti

(10) **Patent No.:** **US D881,714 S**
(45) **Date of Patent:** **** Apr. 21, 2020**

(54) **CONTAINER**

(71) Applicant: **Lumson S.p.a.**, Capergnanica
(Cremona) (IT)

(72) Inventor: **Matteo Moretti**, Crema (IT)

(73) Assignee: **LUMSON S.P.A.**, Capergnanica (CR)
(IT)

(**) Term: **15 Years**

(21) Appl. No.: **29/632,983**

(22) Filed: **Jan. 11, 2018**

(30) **Foreign Application Priority Data**

Jul. 20, 2017 (EP) 004112712

(51) **LOC (12) Cl.** **09-01**

(52) **U.S. Cl.**
USPC **D9/690; D9/691; D9/692**

(58) **Field of Classification Search**
USPC D9/688-692, 682, 500-505; D28/76, 77,
D28/82, 91, 89, 91.1
CPC A45D 34/00-06; A45D 2034/002-007;
A45D 2200/05-058; A45D 40/0068;
A45D 40/0075; A45D 40/0081; B05B
11/00-3098; B65D 83/14; B65D 83/16;
B65D 83/20; B65D 83/205; B65D 83/38;
B65D 83/384; B65D 83/386; B65D 83/40
See application file for complete search history.

(56) **References Cited**

U.S. PATENT DOCUMENTS

D24,203 S * 4/1895 Estes D9/504
D24,991 S * 12/1895 Estes D9/504
D26,704 S * 3/1897 Morningstar D9/503
D114,460 S * 4/1939 Platt D9/504
2,204,784 A * 6/1940 Abrams B65D 81/32
312/31.2

D134,044 S * 10/1942 Vaughn D28/91
D184,789 S * 3/1959 Balbach et al. D9/504
D217,438 S * 5/1970 Balbach et al. D9/504
D219,008 S * 10/1970 Usen D9/504
D220,941 S * 6/1971 Usen D9/688

(Continued)

FOREIGN PATENT DOCUMENTS

CN 301298954 * 8/2010
CN 302990231 * 11/2014

(Continued)

Primary Examiner — Catherine A Tuttle

(74) *Attorney, Agent, or Firm* — Vorys, Sater, Seymour
and Pease LLP

(57) **CLAIM**

The ornamental design for a container, as shown and
described.

DESCRIPTION

FIG. 1 is a perspective view of the container showing my
new design;
FIG. 2 is a rear view thereof;
FIG. 3 is a left side view thereof;
FIG. 4 is a right side view thereof;
FIG. 5 is a front view thereof;
FIG. 6 is a top plan view thereof;
FIG. 7 is a bottom plan view thereof;
FIG. 8 is a perspective showing an alternate embodiment of
my new design;
FIG. 9 is a rear view thereof;
FIG. 10 is a left side view thereof;
FIG. 11 right side view thereof;
FIG. 12 is a front view thereof;
FIG. 13 is a top plan view thereof; and,
FIG. 14 is a bottom plan view thereof.
The broken lines in FIGS. 7 & 14 depict the portions of the
container that form no part of the claimed design.

1 Claim, 7 Drawing Sheets

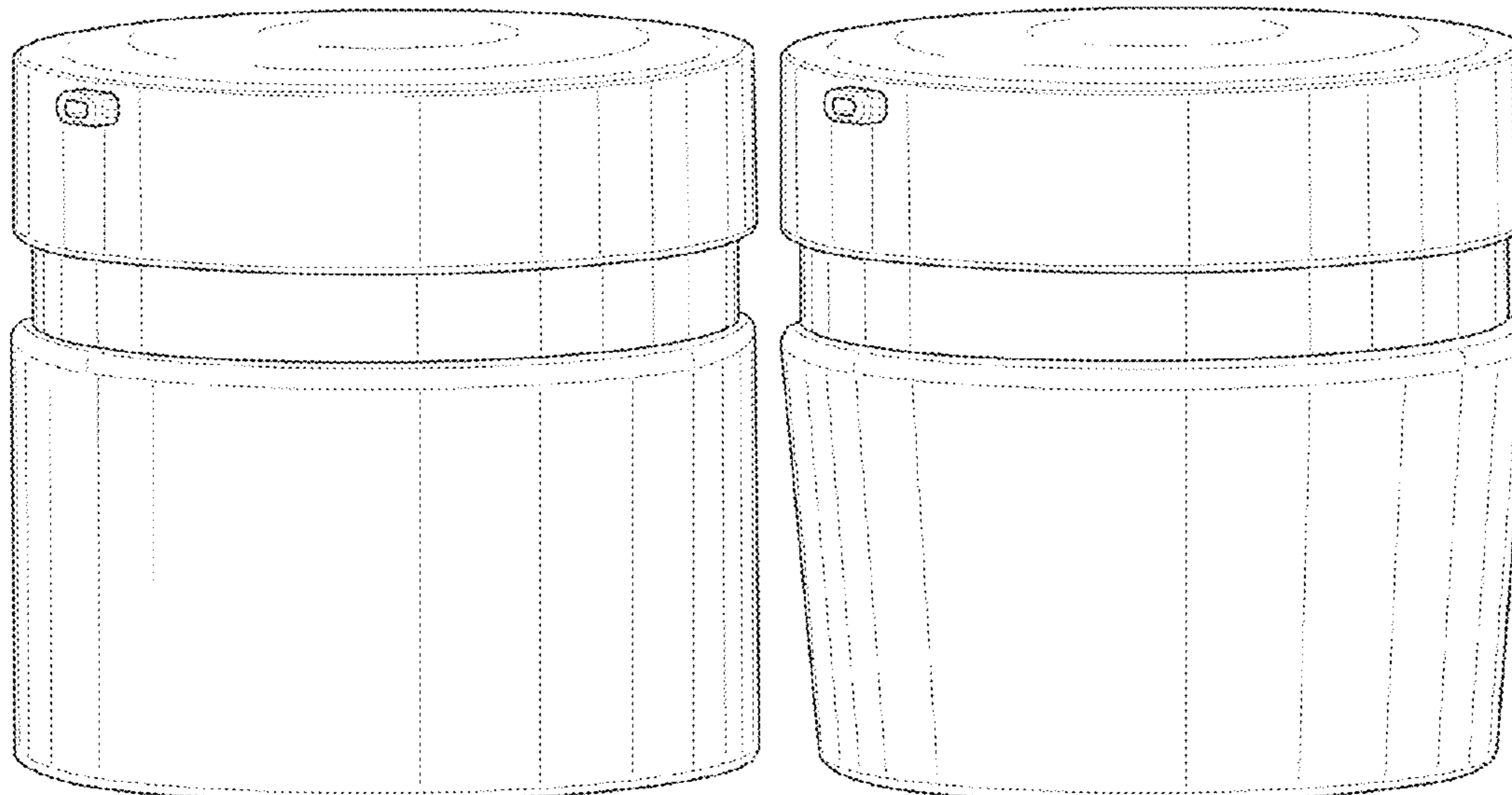

(56)

References Cited

U.S. PATENT DOCUMENTS

D230,011 S * 1/1974 Toland D9/504
 D232,916 S * 9/1974 Bettonica D9/504
 D269,316 S * 6/1983 Conti D7/591
 D274,848 S * 7/1984 Chevassus D28/76
 4,549,674 A * 10/1985 Alticosalian B65D 83/205
 222/135
 D372,535 S * 8/1996 DiCianna D24/176
 D381,259 S * 7/1997 Hayes D9/454
 D409,903 S * 5/1999 Markey D9/692
 D446,456 S * 8/2001 Adachi D9/504
 D474,405 S * 5/2003 Togasawa D9/504
 D486,393 S * 2/2004 Chuang D9/503
 D503,829 S * 4/2005 Tanii D28/76
 D515,426 S * 2/2006 Pace D9/504
 D541,169 S * 4/2007 Ball D9/537
 D595,577 S * 7/2009 Uneno D28/76
 D598,286 S * 8/2009 DeMarco D9/500
 D655,134 S * 3/2012 Gilbert D7/510
 D695,131 S * 12/2013 Mansau D9/690
 D716,666 S * 11/2014 Park D9/690

D756,799 S * 5/2016 Moretti D9/503
 9,579,676 B1 * 2/2017 Burrowes B05B 15/55
 D835,996 S * 12/2018 Otani D9/560
 2007/0289999 A1 * 12/2007 Rossignol B05B 11/0078
 222/137
 2010/0104345 A1 * 4/2010 Nasu B65D 83/0011
 401/68
 2015/0352578 A1 * 12/2015 Burrowes B05B 15/55
 239/304

FOREIGN PATENT DOCUMENTS

CN 304165304 * 6/2017
 CN 304183111 * 6/2017
 EP 0443519 A2 * 8/1991 B05B 11/3084
 KR 300424859.0001 * 9/2006
 KR 300496243.0000 * 6/2008
 KR 300830982.0000 * 12/2015
 KR 300889180.0000 * 1/2017
 KR 300942427.0000 * 2/2018
 WO 0062500-010 * 2/2003

* cited by examiner

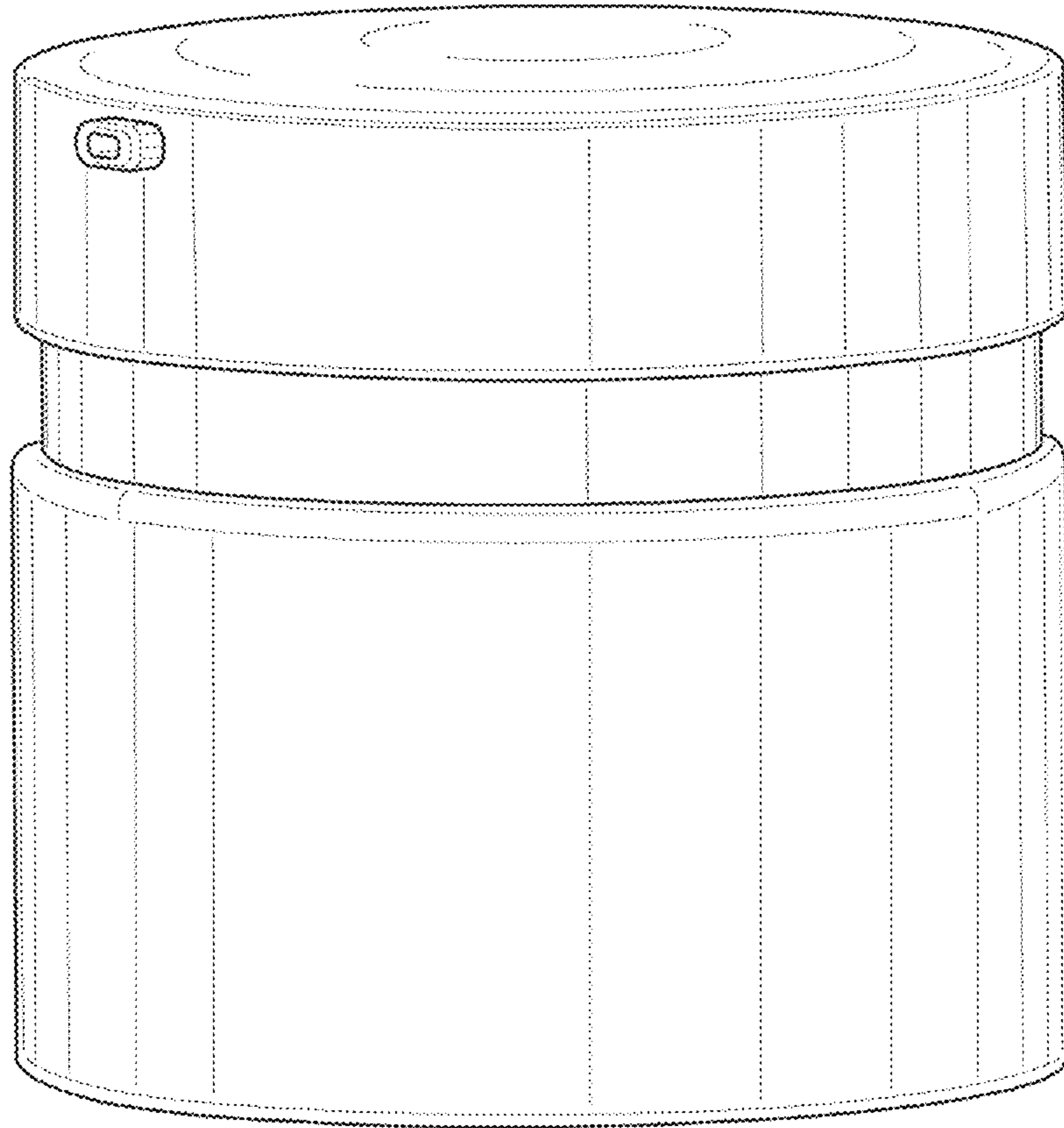

FIG. 1

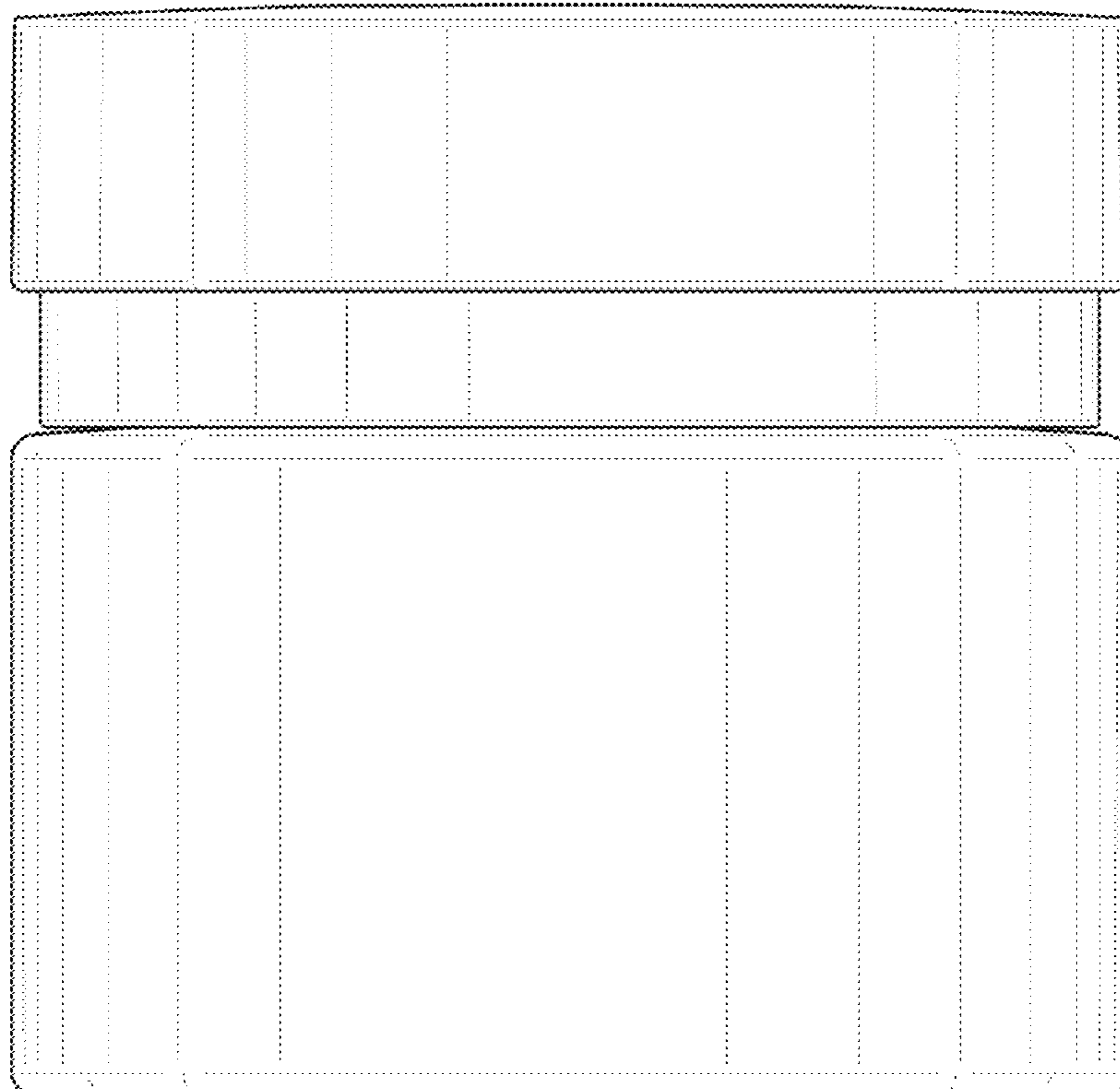

FIG. 2

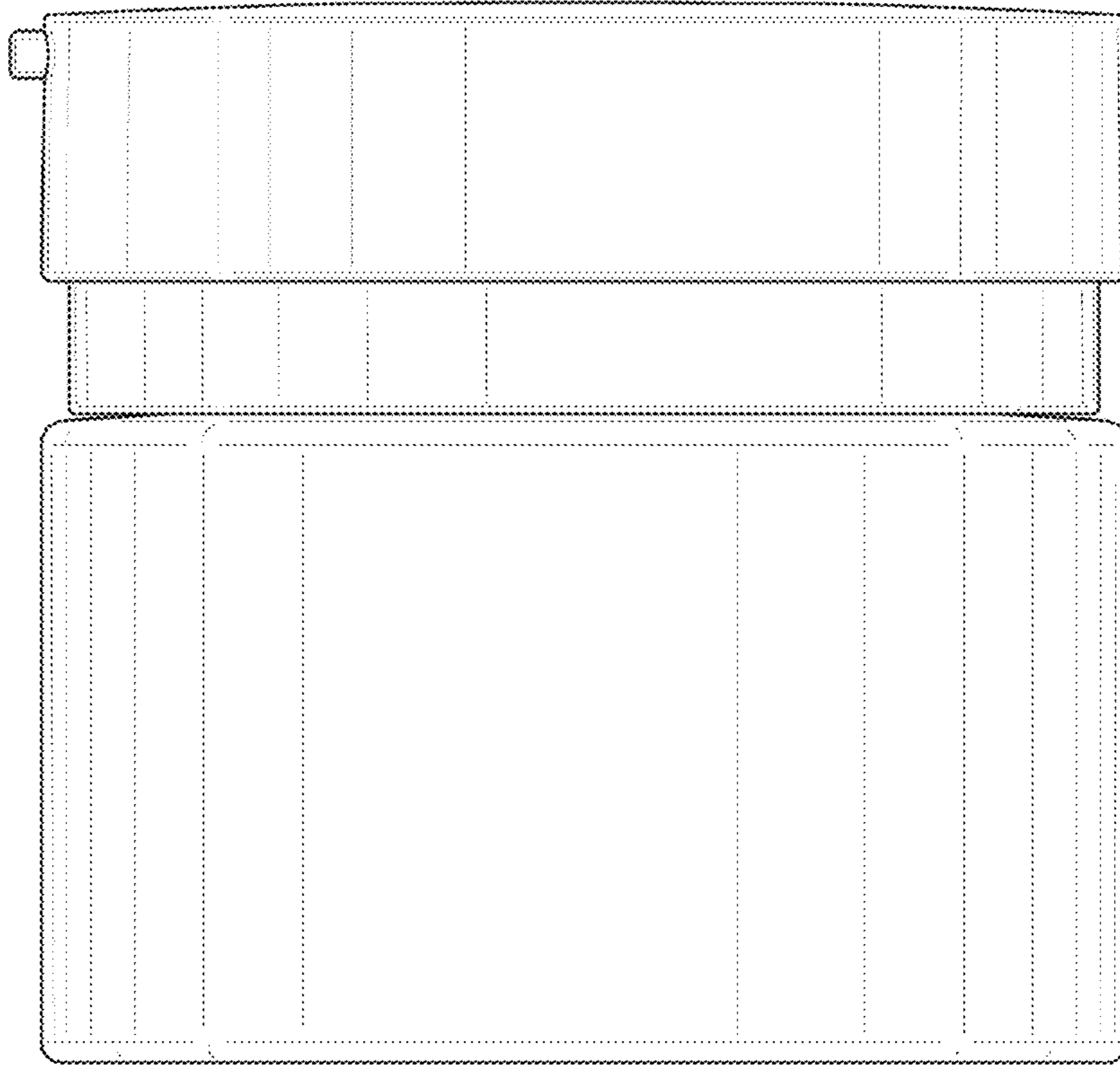

FIG. 3

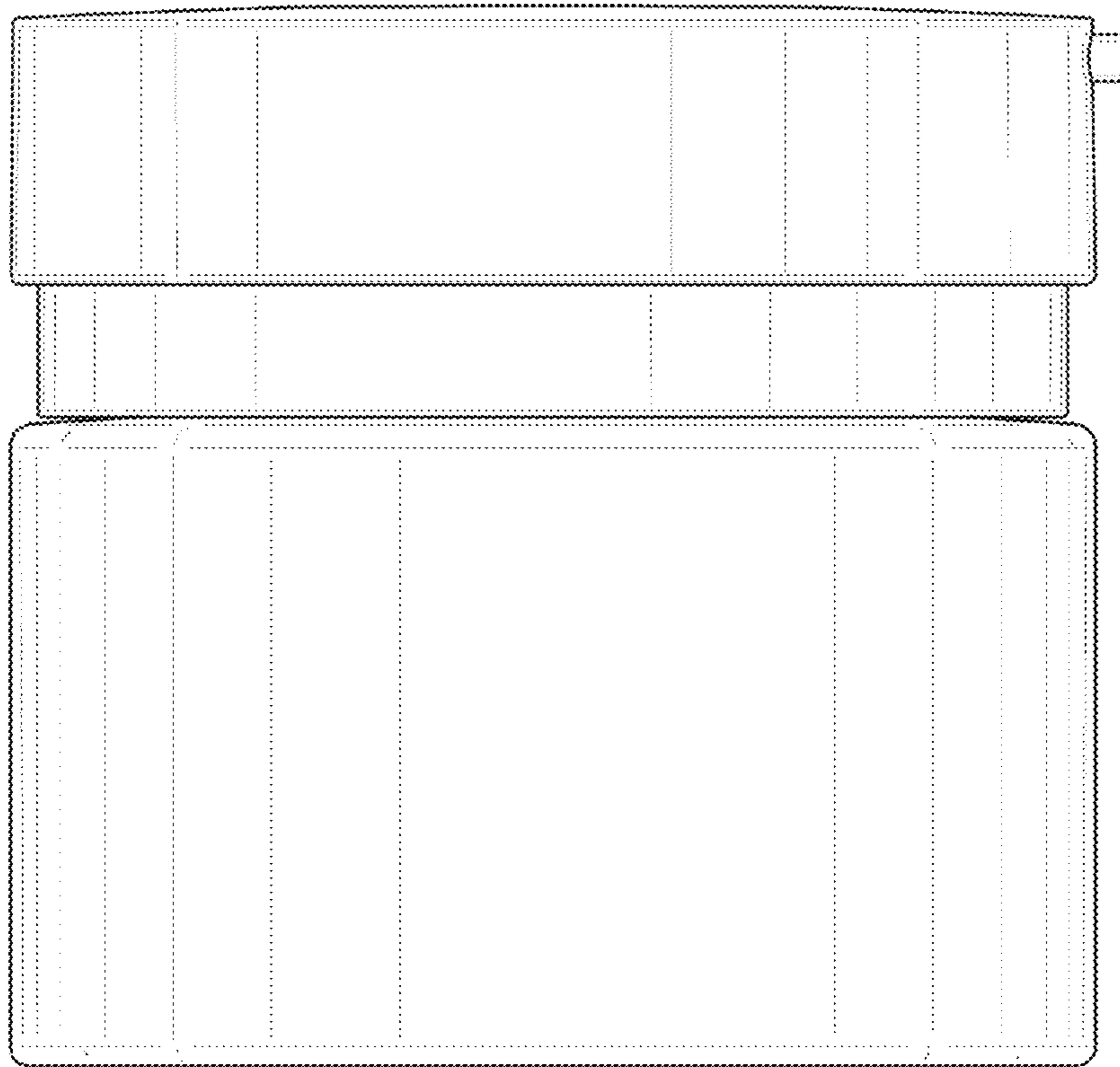

FIG. 4

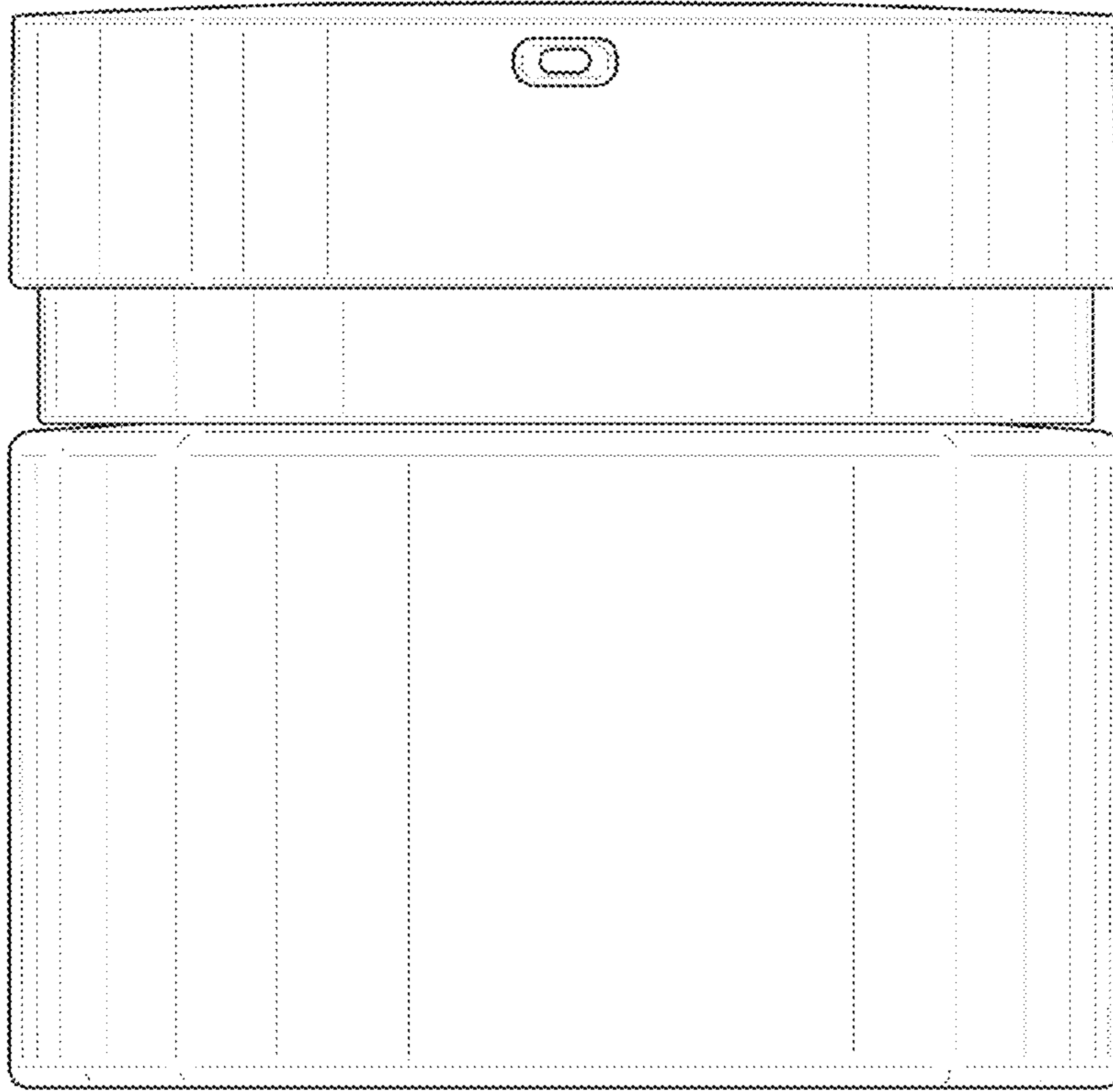

FIG. 5

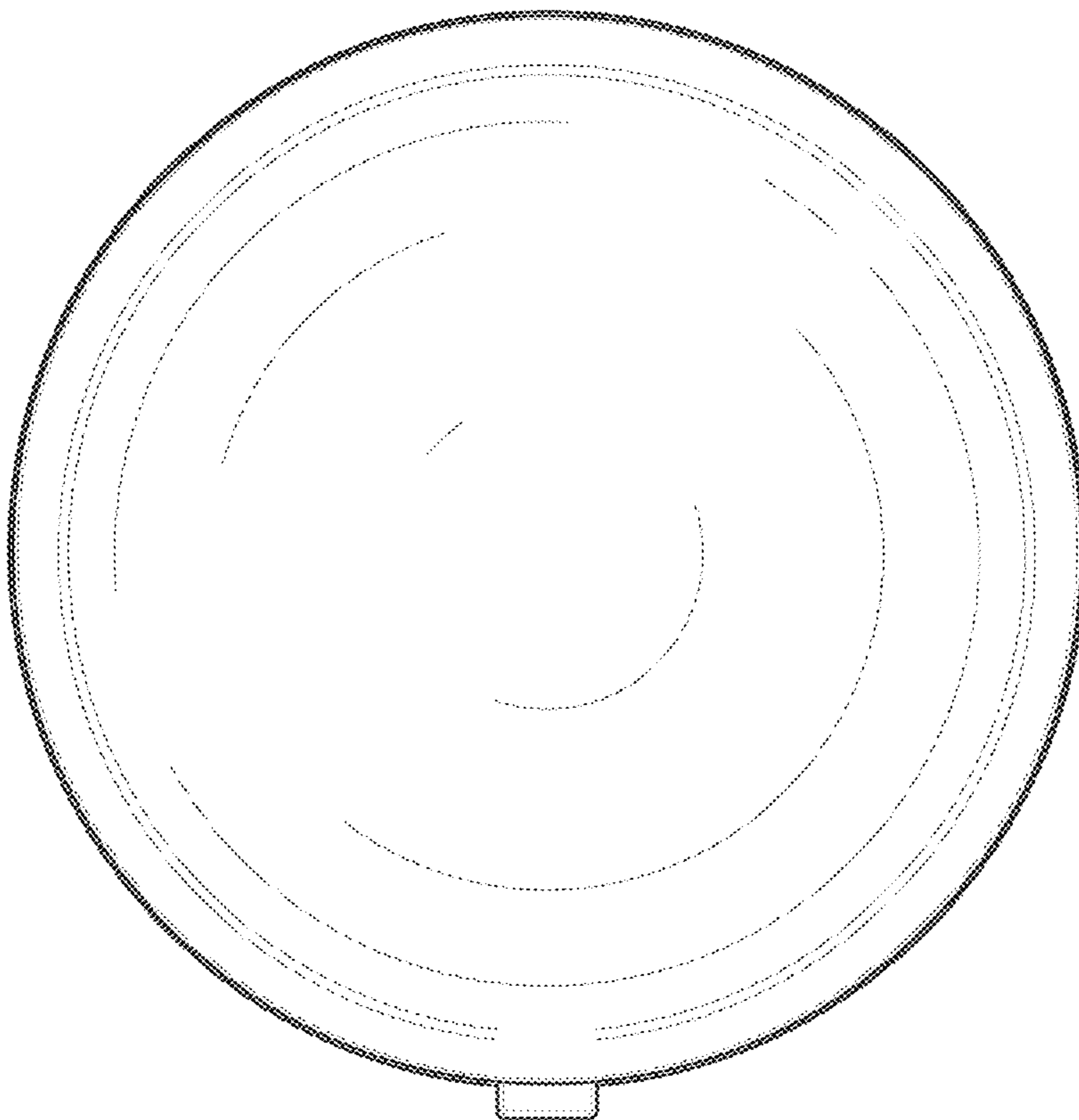

FIG. 6

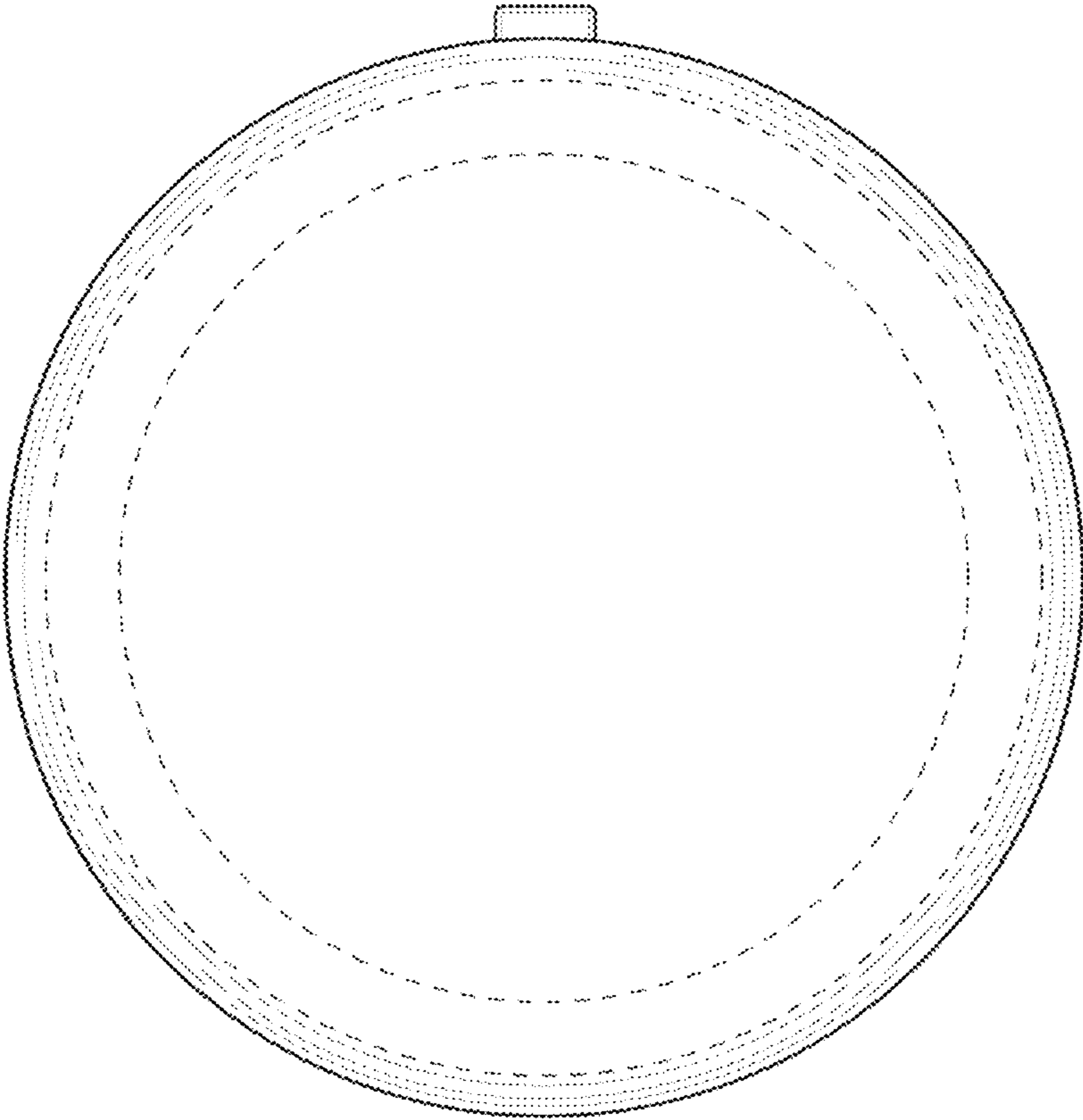

FIG. 7

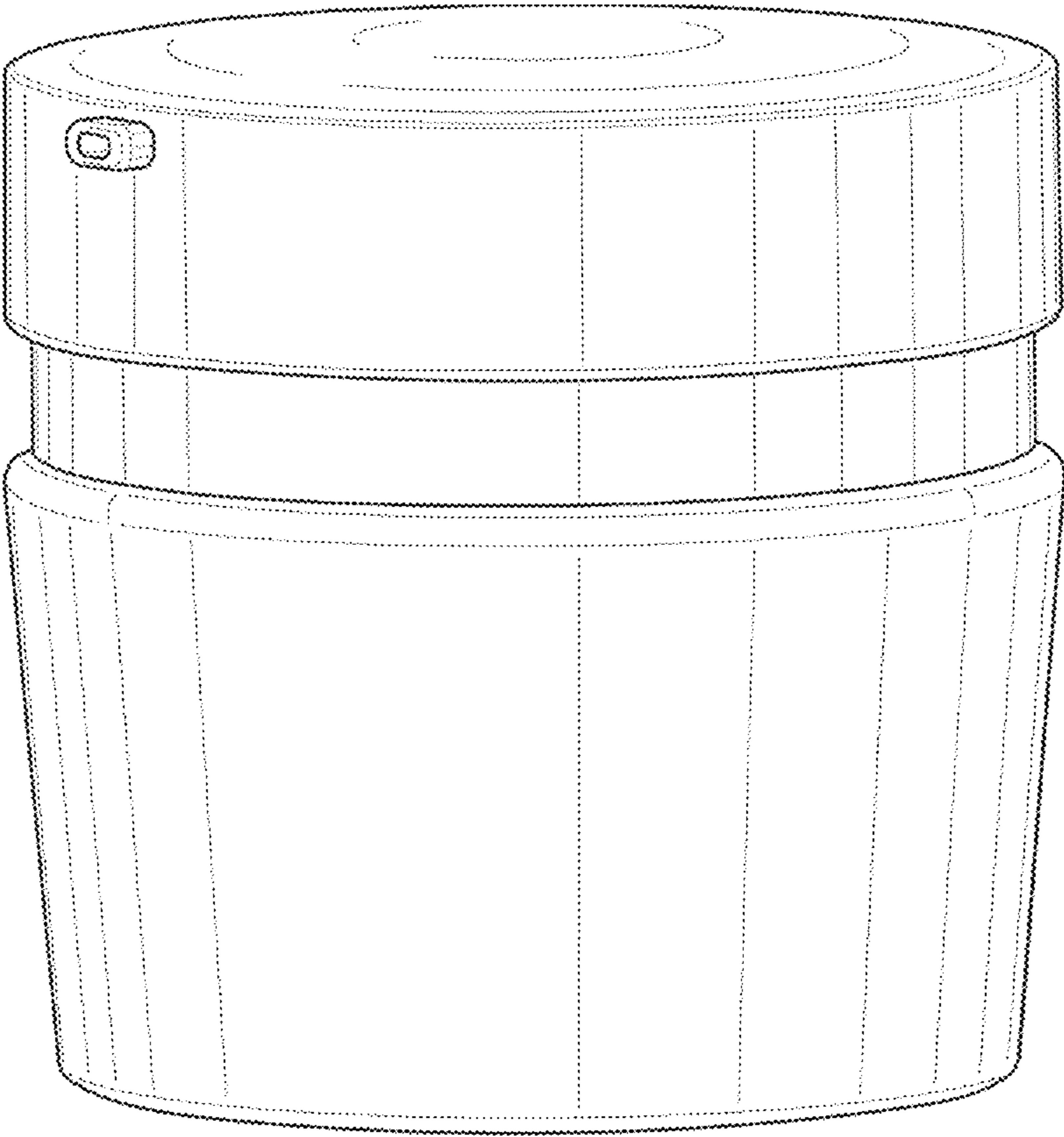

FIG. 8

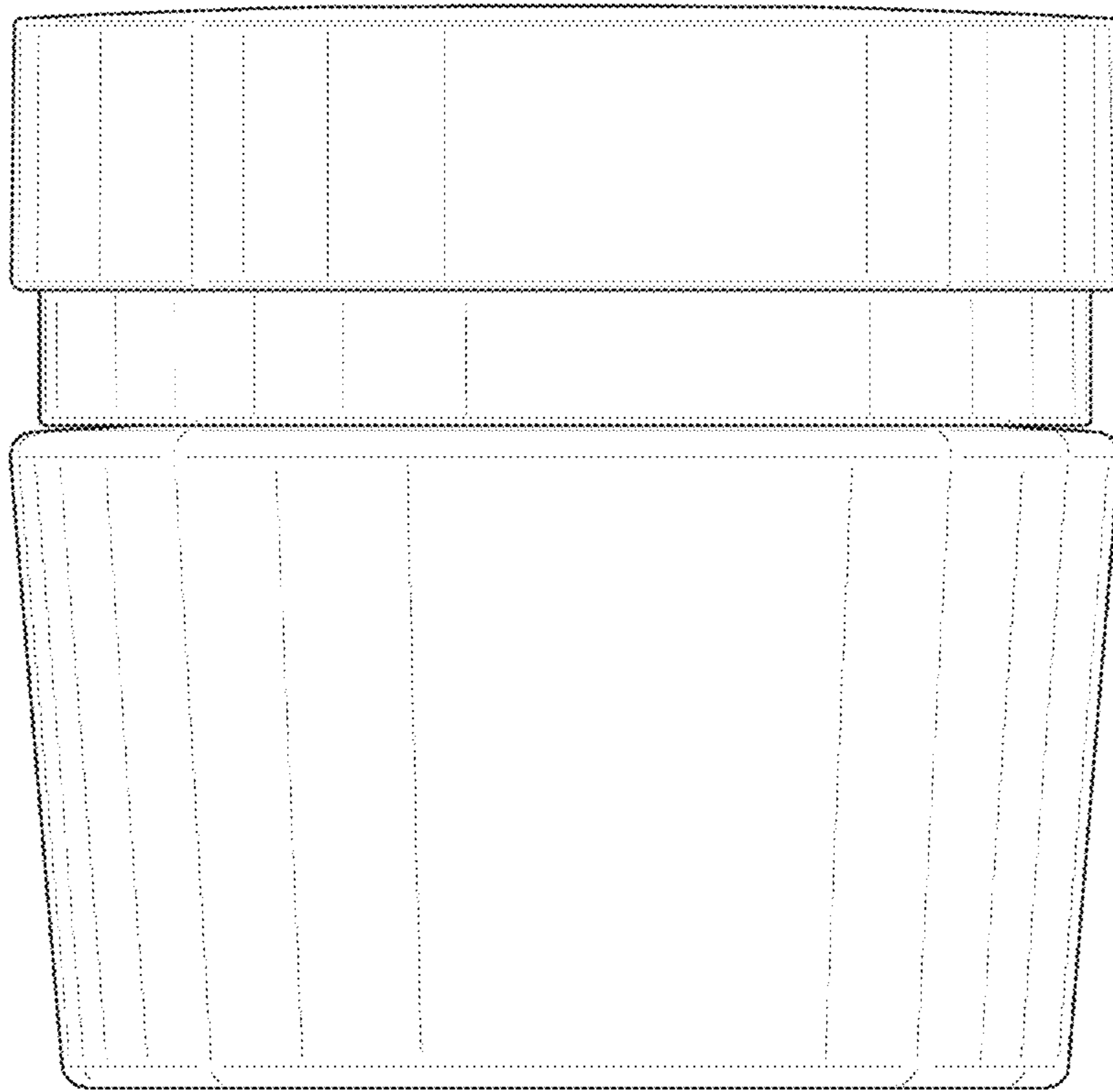

FIG. 9

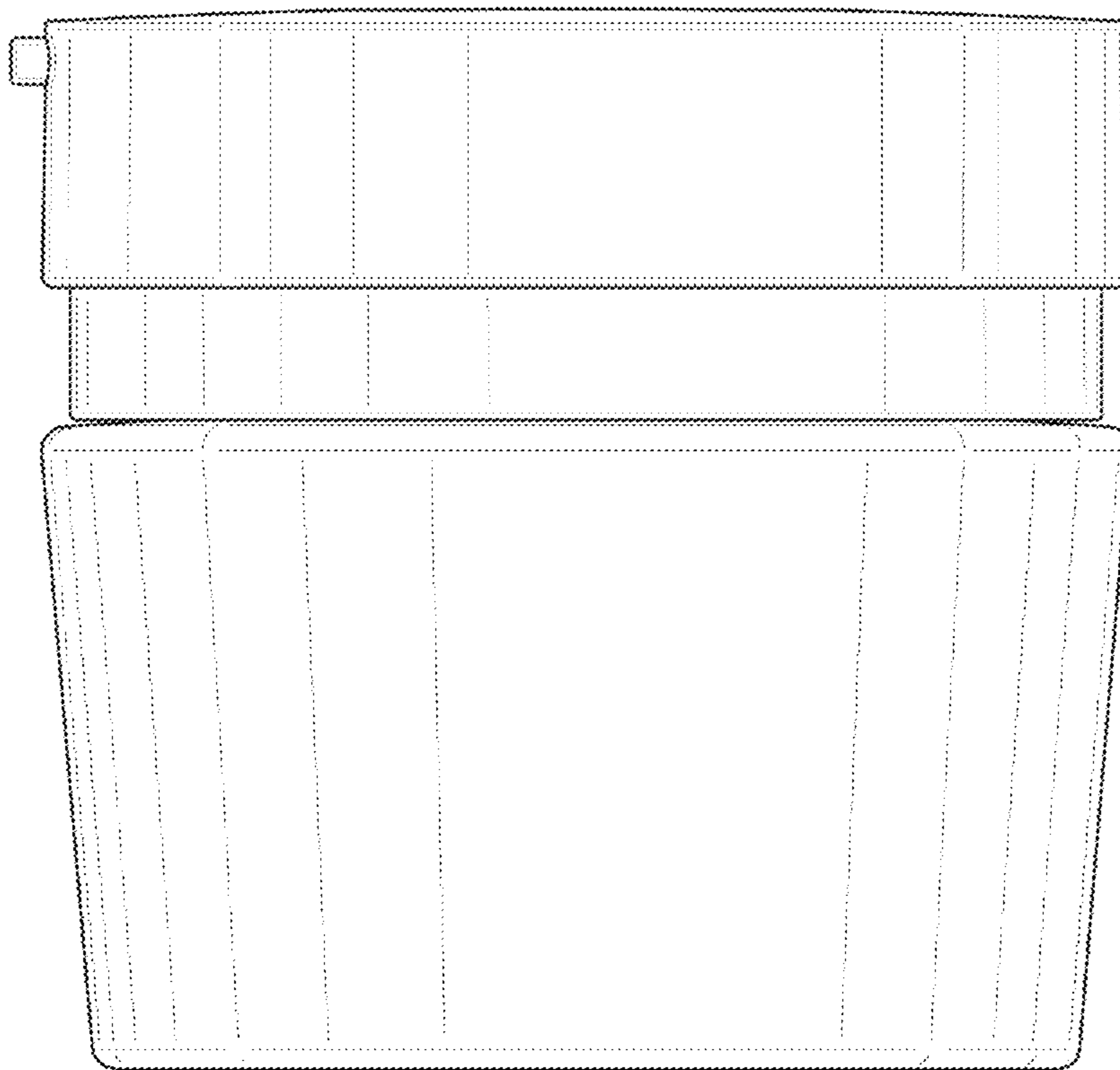

FIG. 10

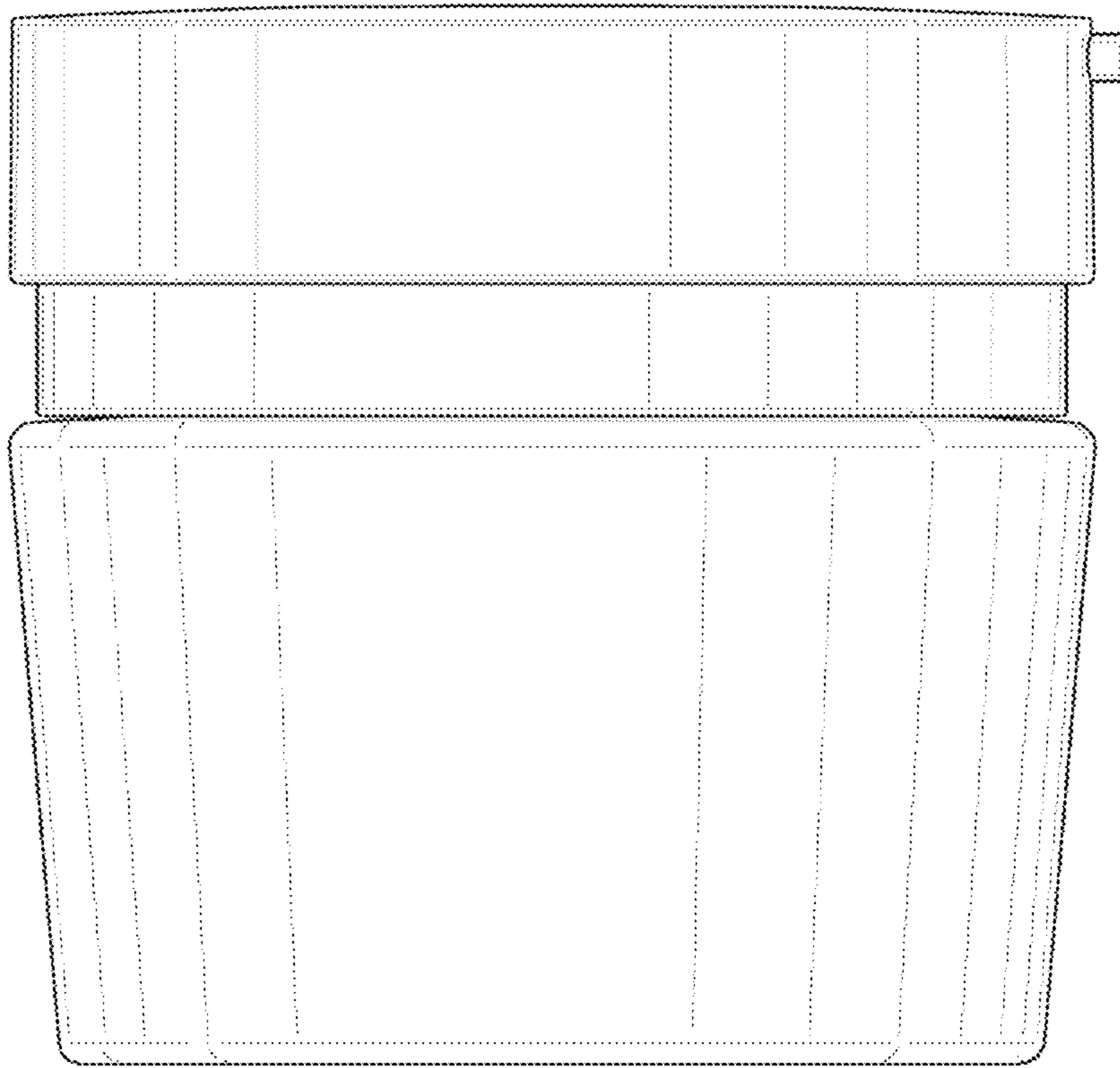

FIG. 11

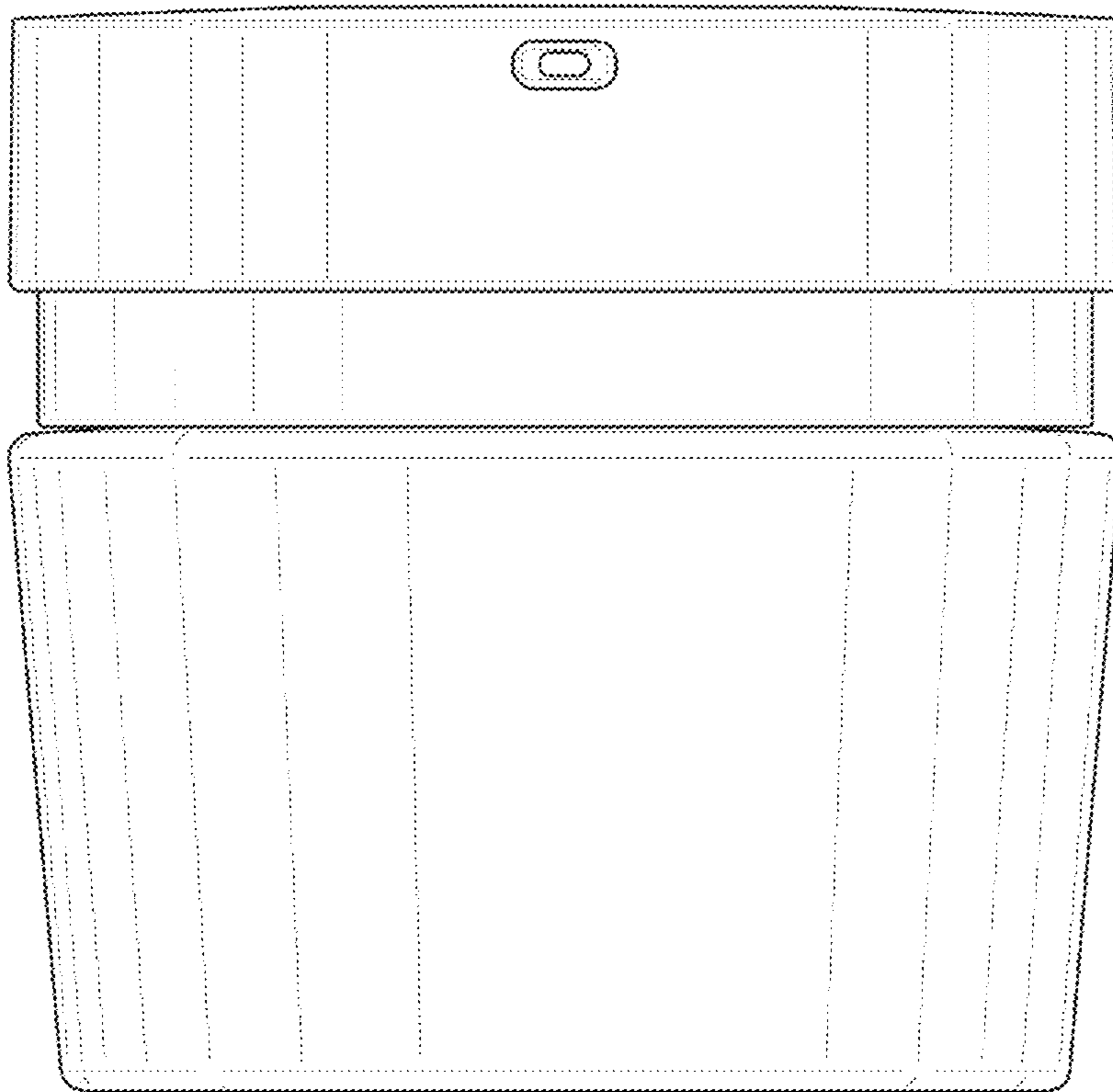

FIG. 12

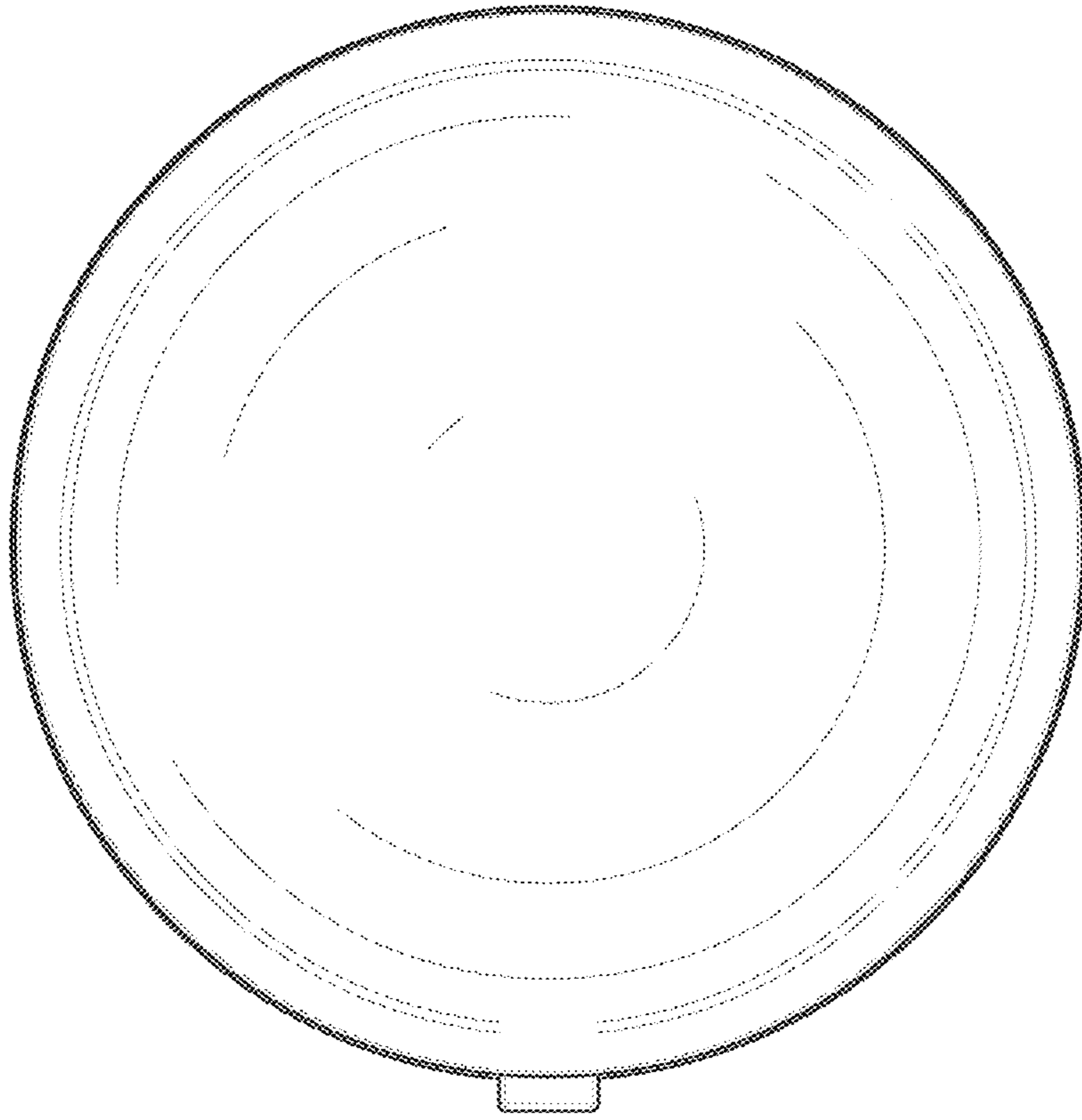

FIG. 13

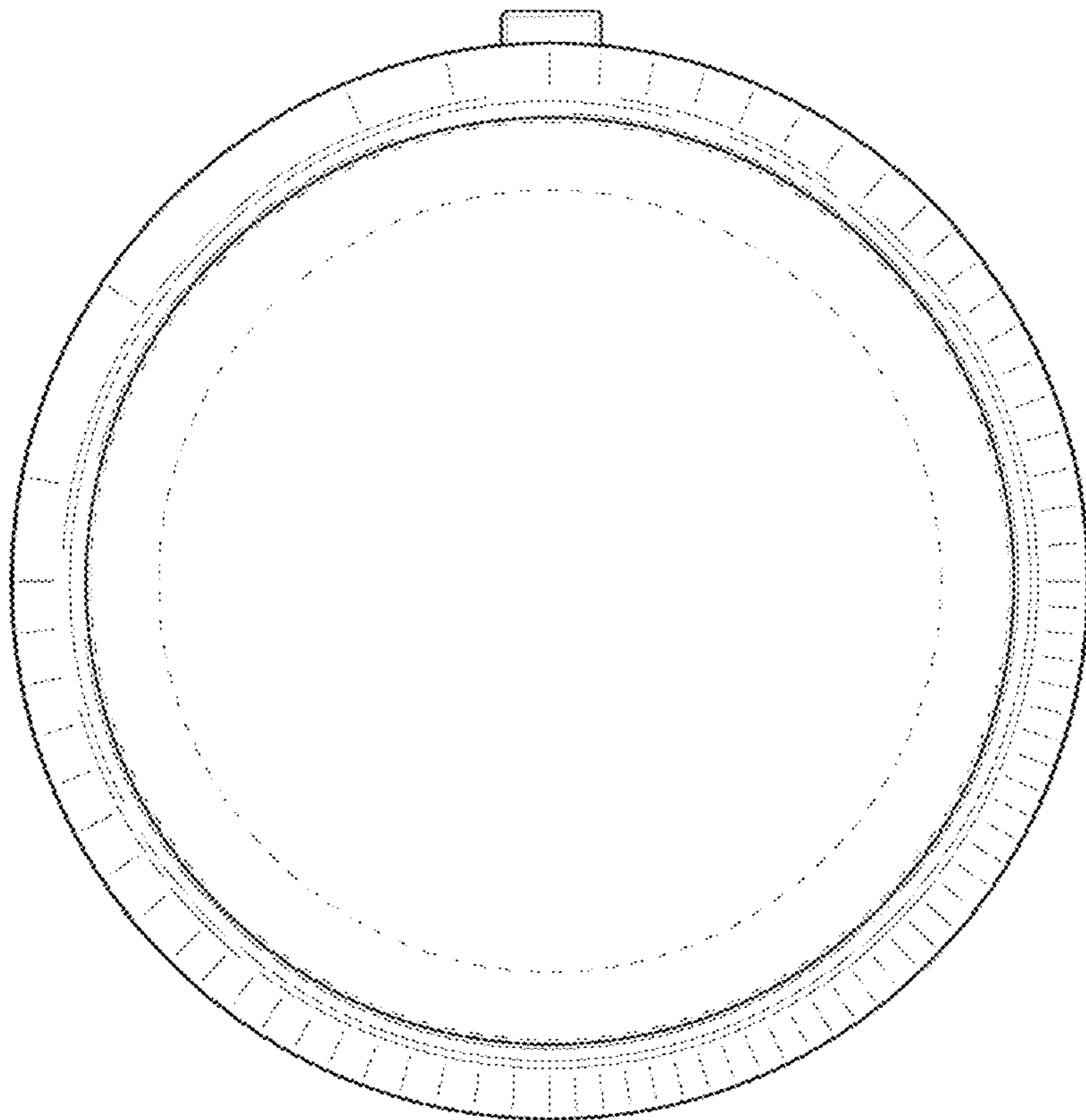

FIG. 14