



US00D881681S

(12) **United States Design Patent**
Mojica

(10) **Patent No.:** **US D881,681 S**
(45) **Date of Patent:** **** Apr. 21, 2020**

- (54) **MULTI-TOOL CARABINER**
- (71) Applicant: **Outdoor Element, LLC**, Englewood, CO (US)
- (72) Inventor: **Michael John Mojica**, Englewood, CO (US)
- (73) Assignee: **Outdoor Element, LLC**, Englewood, CO (US)
- (**) Term: **15 Years**
- (21) Appl. No.: **29/674,460**
- (22) Filed: **Dec. 21, 2018**
- (51) **LOC (12) Cl.** **09-06**
- (52) **U.S. Cl.**
USPC **D8/356**
- (58) **Field of Classification Search**
USPC D8/356, 354, 349, 99, 105; D13/155;
320/107; 403/322.2; D3/201; 431/274
CPC H02J 7/0026; H02J 7/0021; H02J 7/0027;
Y02E 60/12; F16B 45/00; F16B 7/042;
F23Q 1/06
See application file for complete search history.

Primary Examiner — Cynthia R Underwood
(74) *Attorney, Agent, or Firm* — Venable LLP; Tamatane J. Aga; Elizabeth C. G. Gitlin

(57) **CLAIM**

The ornamental design for a multi-tool carabiner, as shown and described.

DESCRIPTION

FIG. 1 is a first perspective view of a multi-tool carabiner showing my design;
 FIG. 2 is a left side view of FIG. 1;
 FIG. 3 is a right side view of FIG. 1.
 FIG. 4 is a front view of FIG. 1;
 FIG. 5 is a rear view of FIG. 1;
 FIG. 6 is a top view of the FIG. 1;
 FIG. 7 is a bottom view of the FIG. 1;
 FIG. 8 is a second perspective view of FIG. 1;
 FIG. 9 is a third perspective view of FIG. 1;
 FIG. 10 is a first perspective view of FIG. 1 including a tool attached thereto;
 FIG. 11 is a left side view of FIG. 10;
 FIG. 12 is a right side view of FIG. 10;
 FIG. 13 is a front view of FIG. 10;
 FIG. 14 is a rear view of FIG. 10;
 FIG. 15 is a top view of FIG. 10;
 FIG. 16 is a bottom view of FIG. 10;
 FIG. 17 is a second perspective view of FIG. 10; and,
 FIG. 18 is a third perspective view of FIG. 10 with the tool exploded from the multi-tool carabiner.
 The features shown in broken lines represent portions of the multi-tool carabiner which form no part of the claimed design.

(56) **References Cited**

U.S. PATENT DOCUMENTS

4,384,799	A	5/1983	Shklovsky	
4,745,661	A	5/1988	Wainscott	
5,169,305	A	12/1992	Kee	
5,181,847	A	1/1993	Da Silva	
5,271,730	A	12/1993	Acacio da Silva	
D444,685	S	7/2001	Shenkel et al.	
6,592,362	B2	7/2003	Fisher	
D483,519	S	12/2003	Liu et al.	
6,764,301	B2*	7/2004	Paleno	F23Q 1/06 29/513

(Continued)

OTHER PUBLICATIONS

Firebiner, Outdoor Element, reviewed on May 8, 2017 on outdoor-element.com, retrieved on Oct. 15, 2018, retrieved from the Internet URL: <http://www.outdoorelement.com/product/firebiner/>.

(Continued)

1 Claim, 18 Drawing Sheets

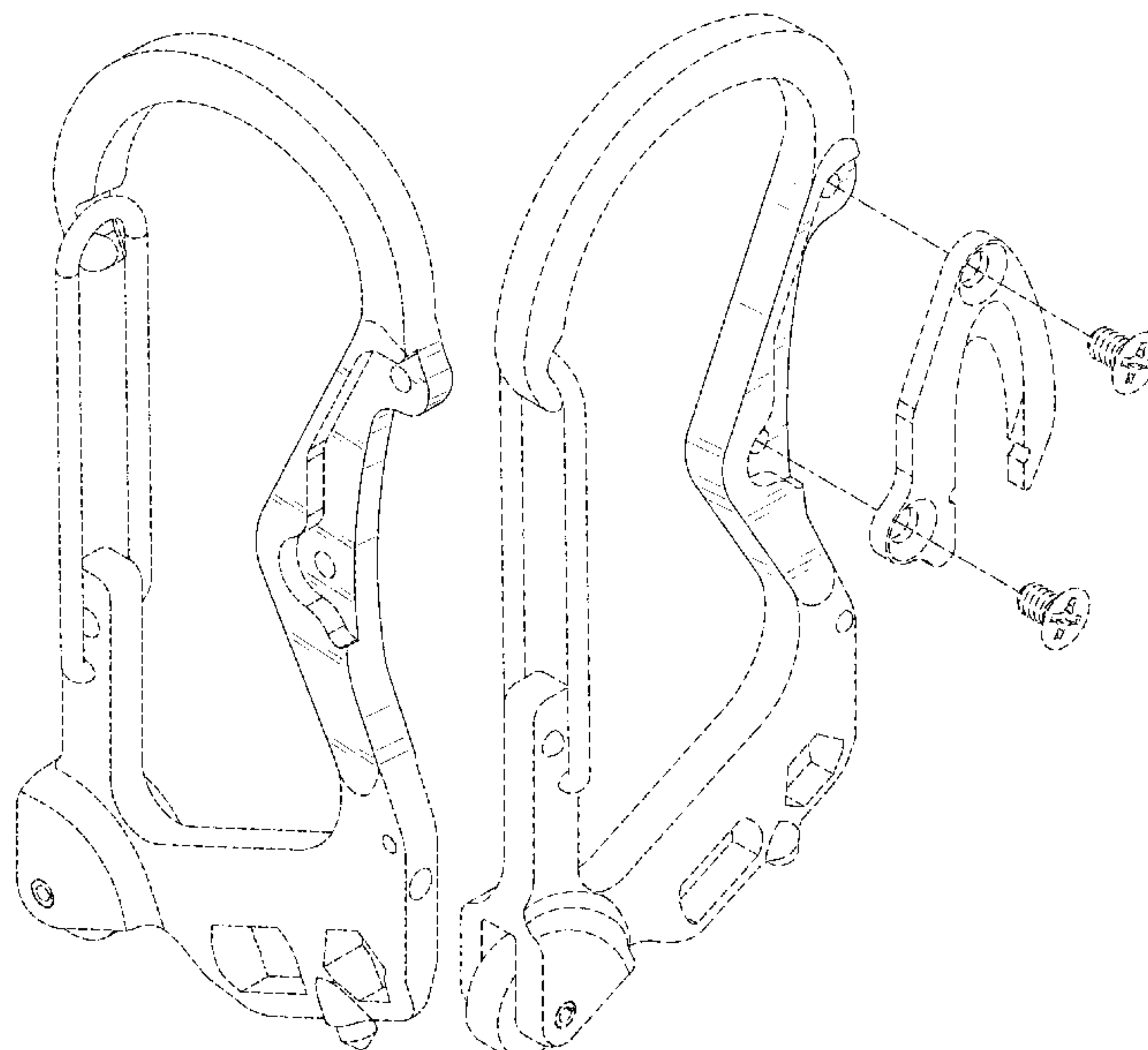

(56)

References Cited

U.S. PATENT DOCUMENTS

D504,975 S 5/2005 Xu
 7,126,484 B1 10/2006 Luquire
 7,695,274 B2 4/2010 Caruso, II
 D622,574 S 8/2010 Garcia et al.
 D693,207 S * 11/2013 Petzl D8/356
 D701,740 S * 4/2014 Lee D8/99
 8,966,690 B2 3/2015 Stokes et al.
 D725,998 S * 4/2015 McEvilly D8/367
 9,175,717 B2 11/2015 Tardif
 9,180,535 B2 11/2015 Vanderbeek
 D746,656 S 1/2016 Smith et al.
 9,296,587 B2 3/2016 Gonzalez et al.
 9,427,858 B2 * 8/2016 Duncan B25F 1/04
 D773,274 S 12/2016 Berman
 9,682,469 B2 6/2017 Heise
 9,707,419 B2 7/2017 Perner
 D807,725 S 1/2018 Chalfant

9,927,122 B2 * 3/2018 Mundhra F23Q 1/06
 D837,930 S * 1/2019 Draï D22/117
 D860,764 S * 9/2019 Kelleghan D8/356
 2005/0144730 A1 7/2005 Barber et al.
 2014/0059782 A1 3/2014 Duncan et al.
 2014/0127984 A1 5/2014 Smith et al.
 2016/0166012 A1 6/2016 Mojica
 2017/0066118 A1 3/2017 Berman
 2018/0003383 A1 1/2018 Stonis et al.
 2018/0100649 A1 4/2018 Mojica
 2018/0117779 A1 5/2018 Mojica

OTHER PUBLICATIONS

Nomad Survival Tool, reviewed by Melissa Miller, published on Jul. 27, 2017 on youtube.com, retrieved on Oct. 19, 2018, retrieved from the Internet URL: <http://www.youtube.com/watch?v=4ENwK29Gwb0>.

* cited by examiner

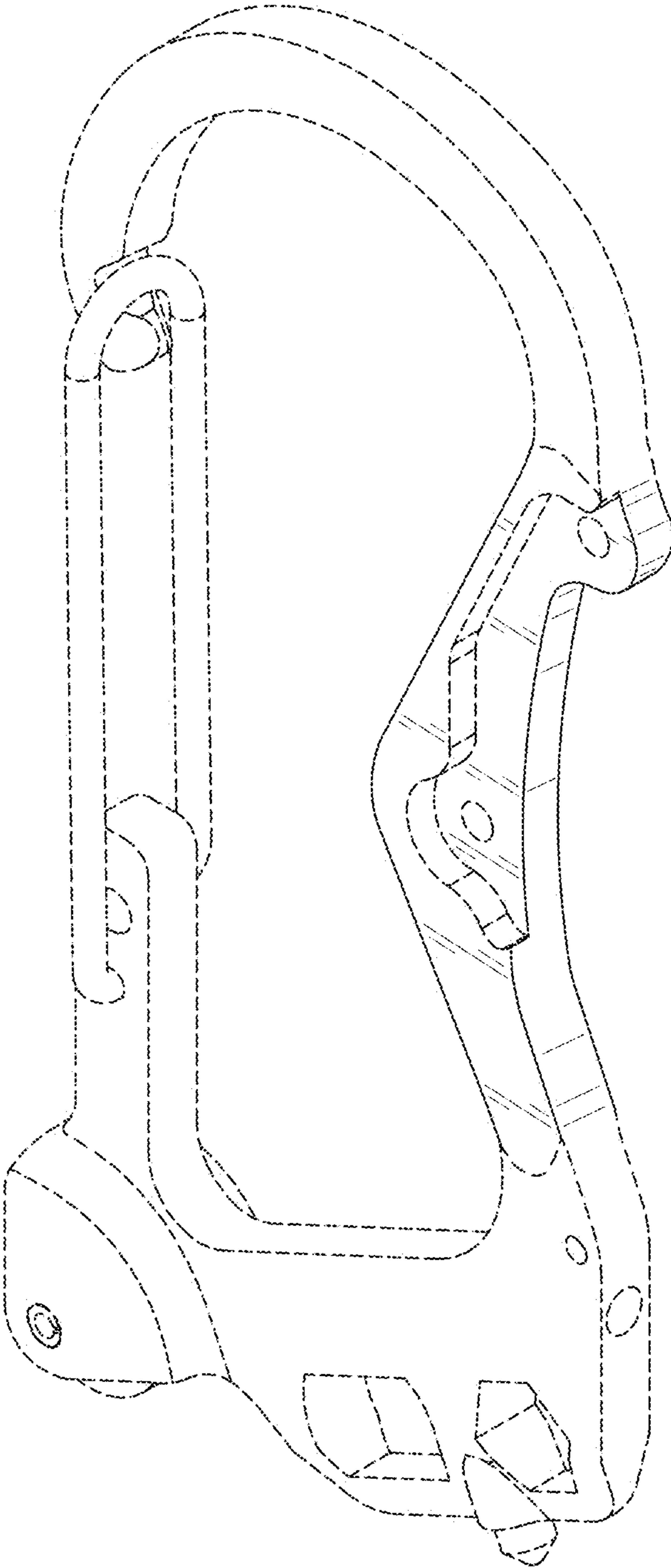

FIG. 1

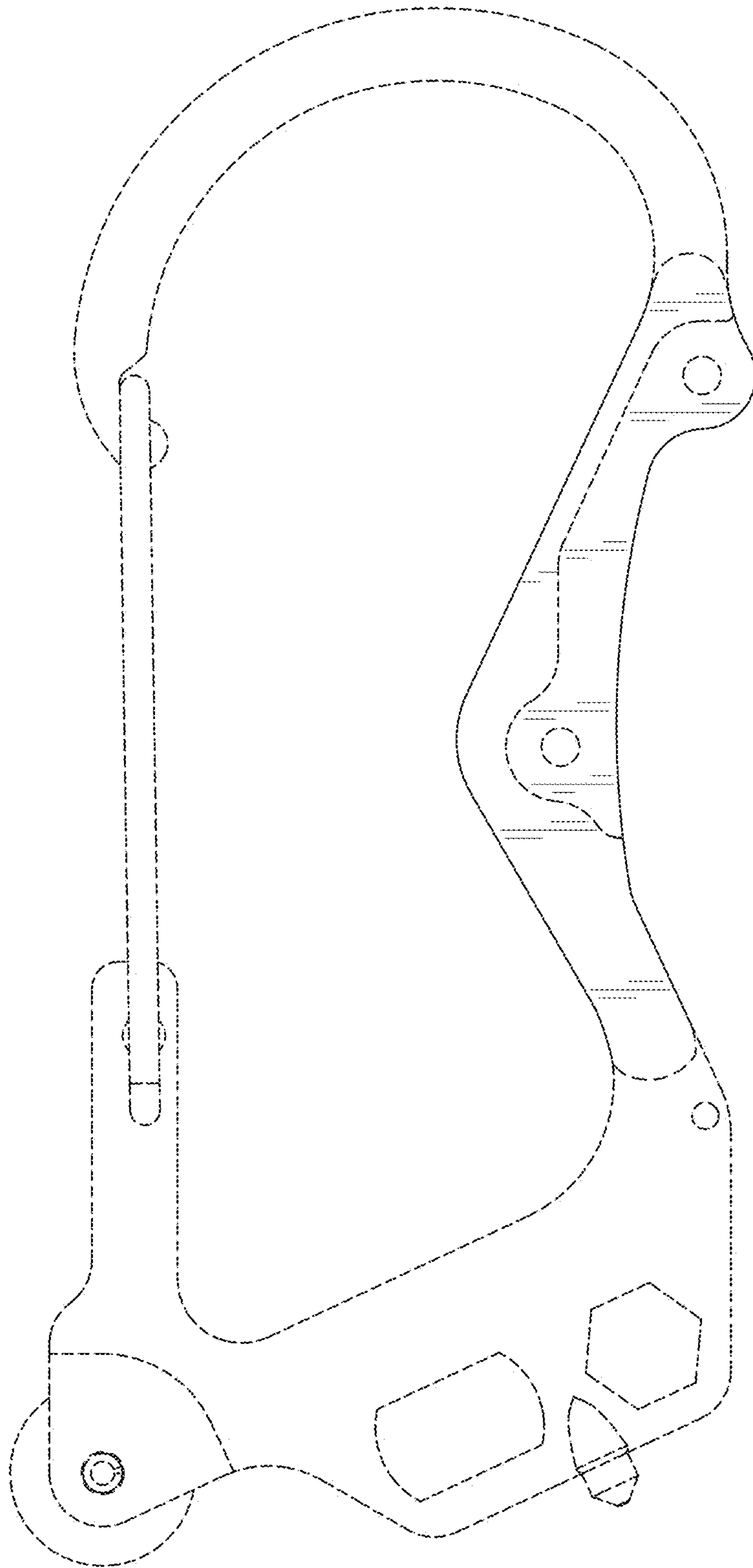

FIG. 2

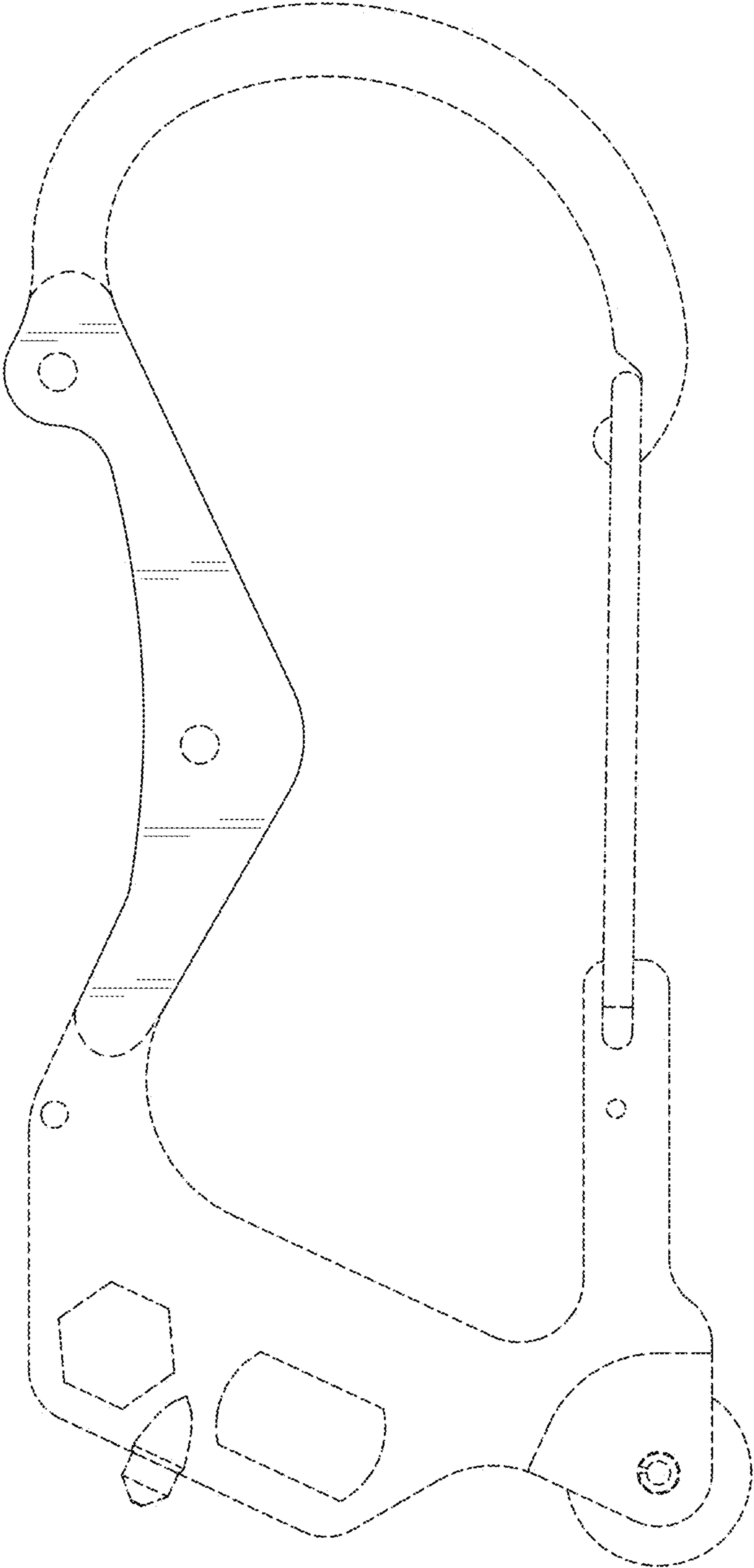

FIG. 3

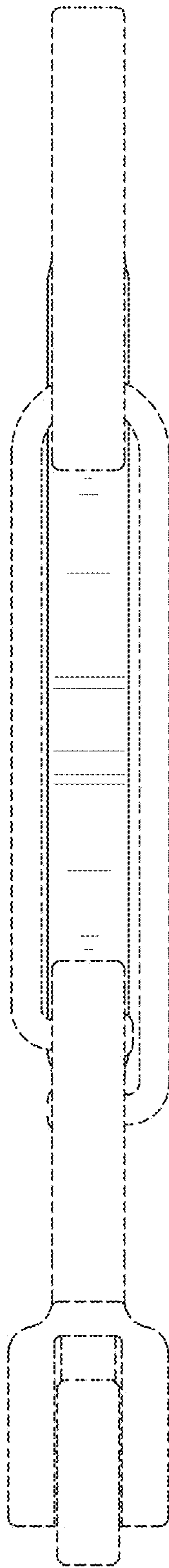

FIG. 4

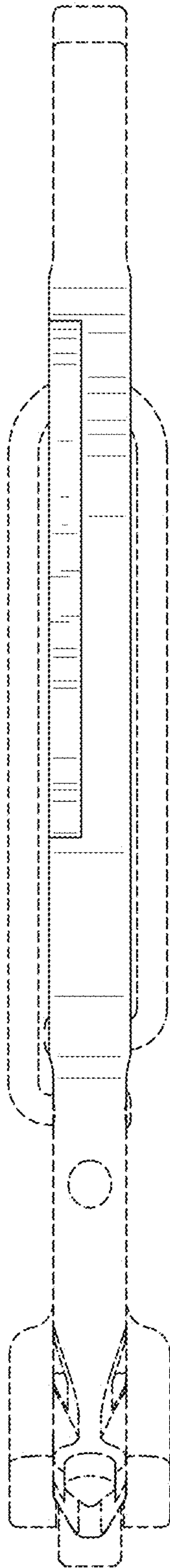

FIG. 5

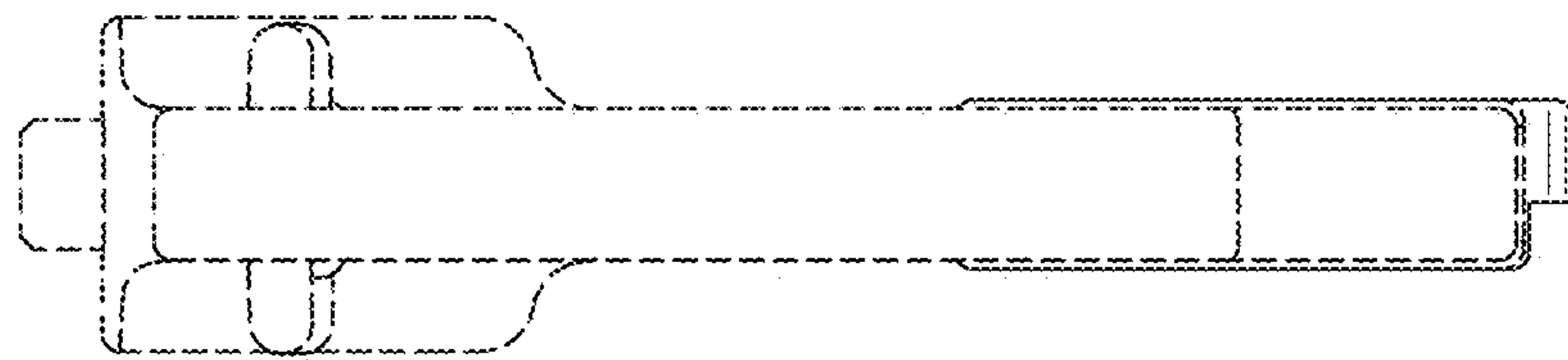

FIG. 6

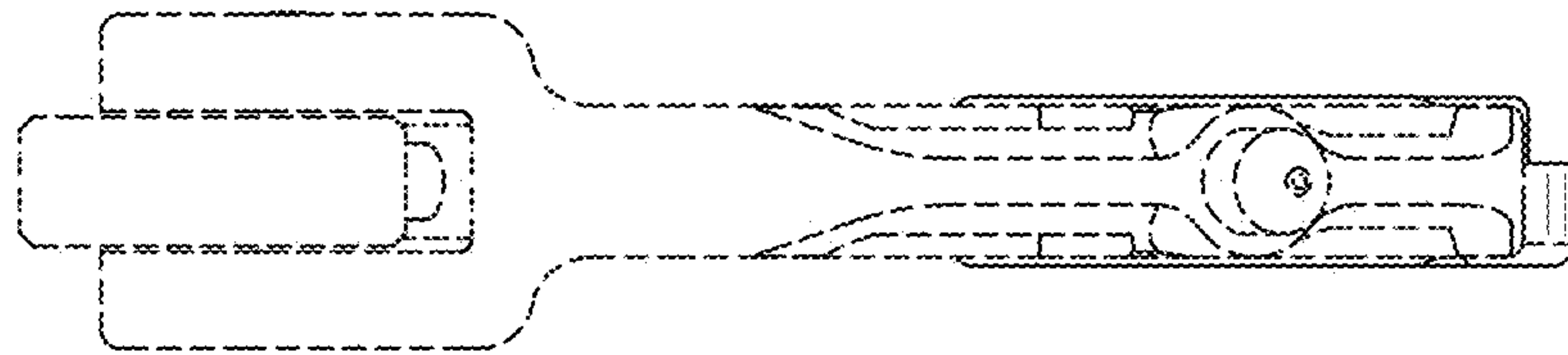

FIG. 7

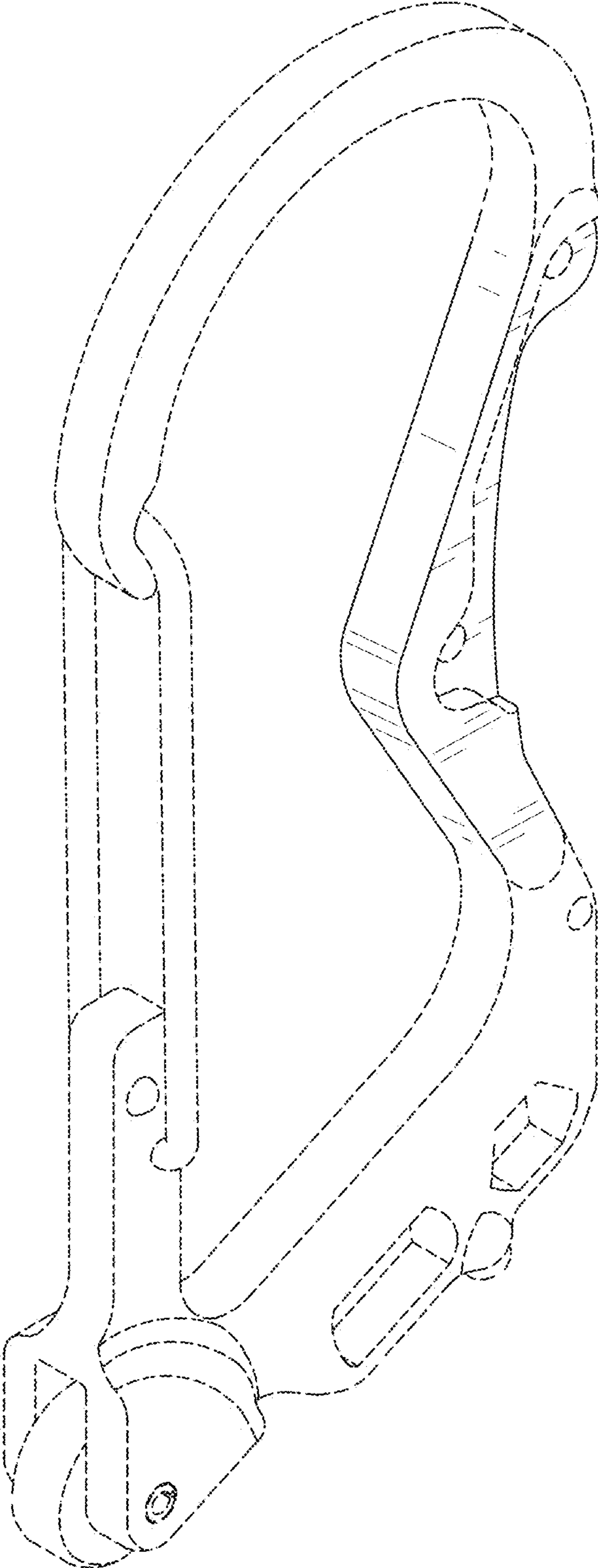

FIG. 8

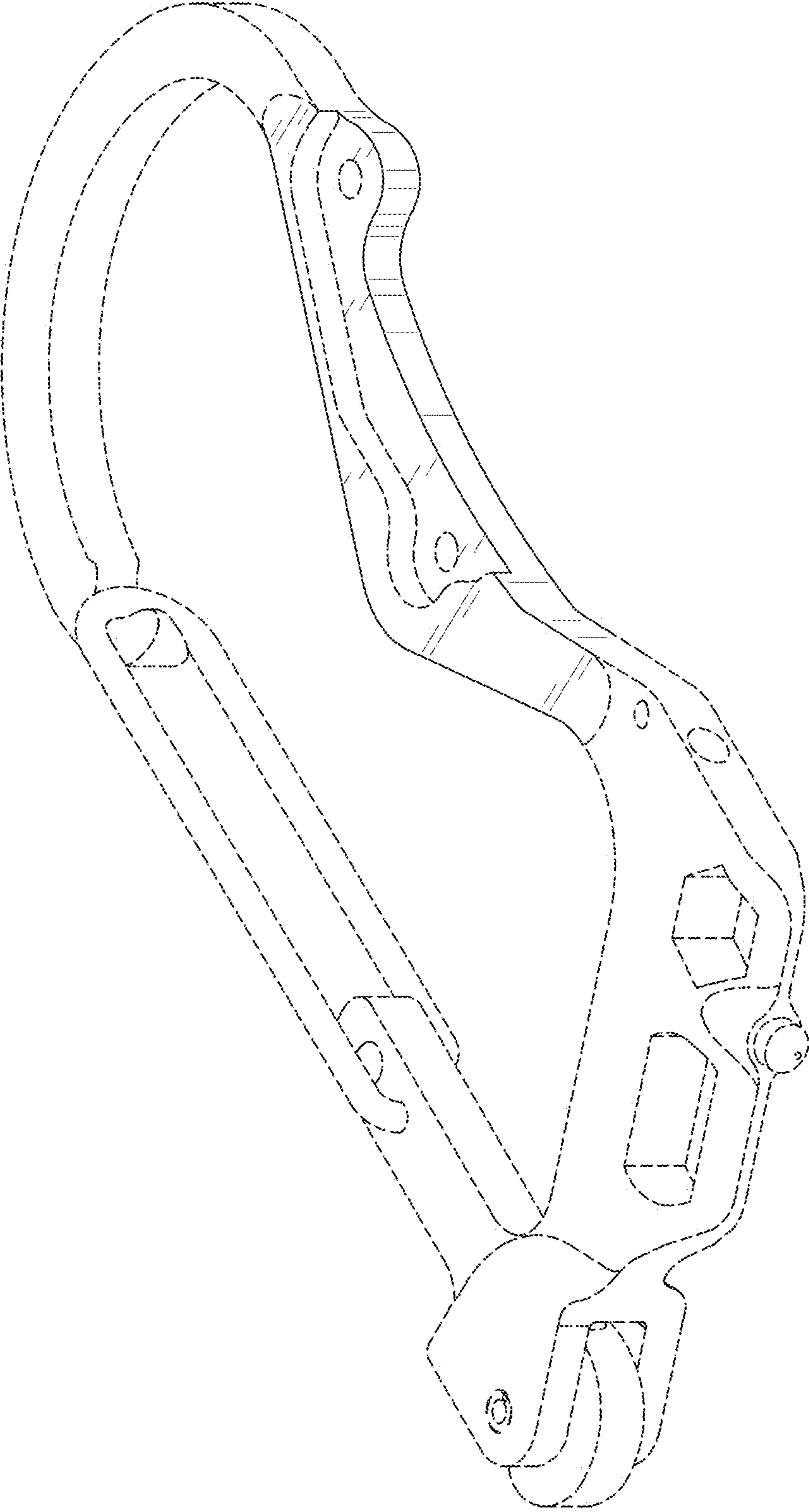

FIG. 9

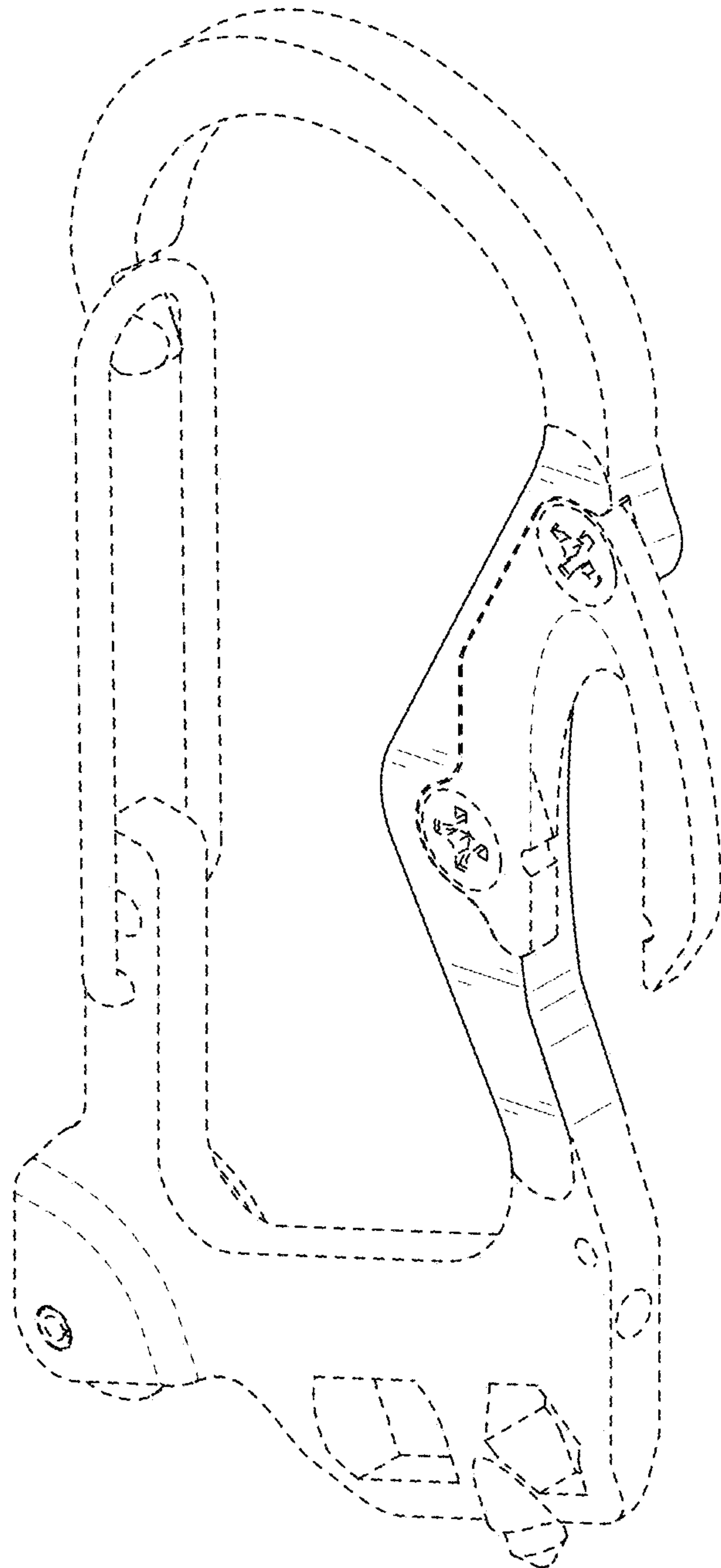

FIG. 10

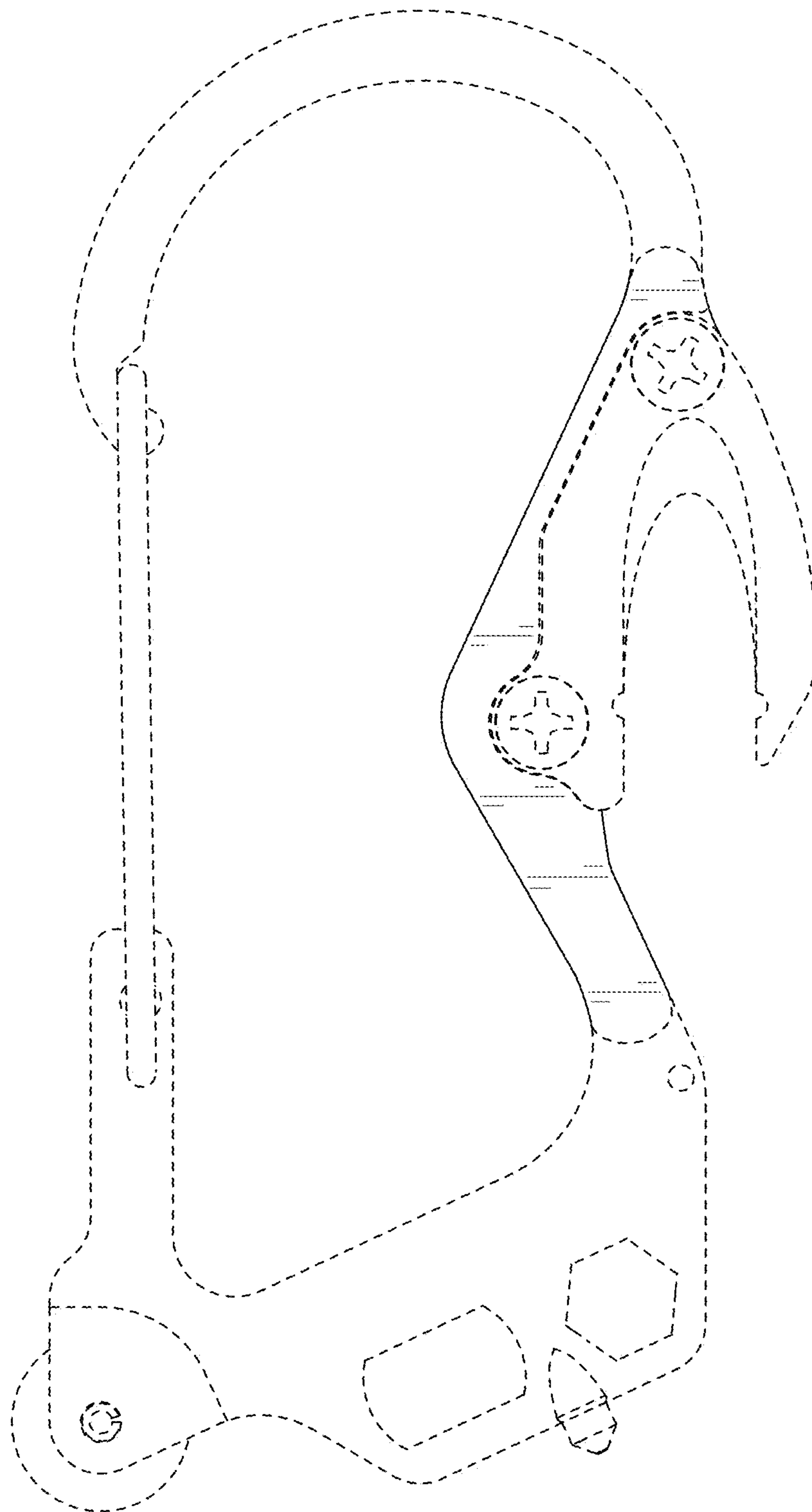

FIG. 11

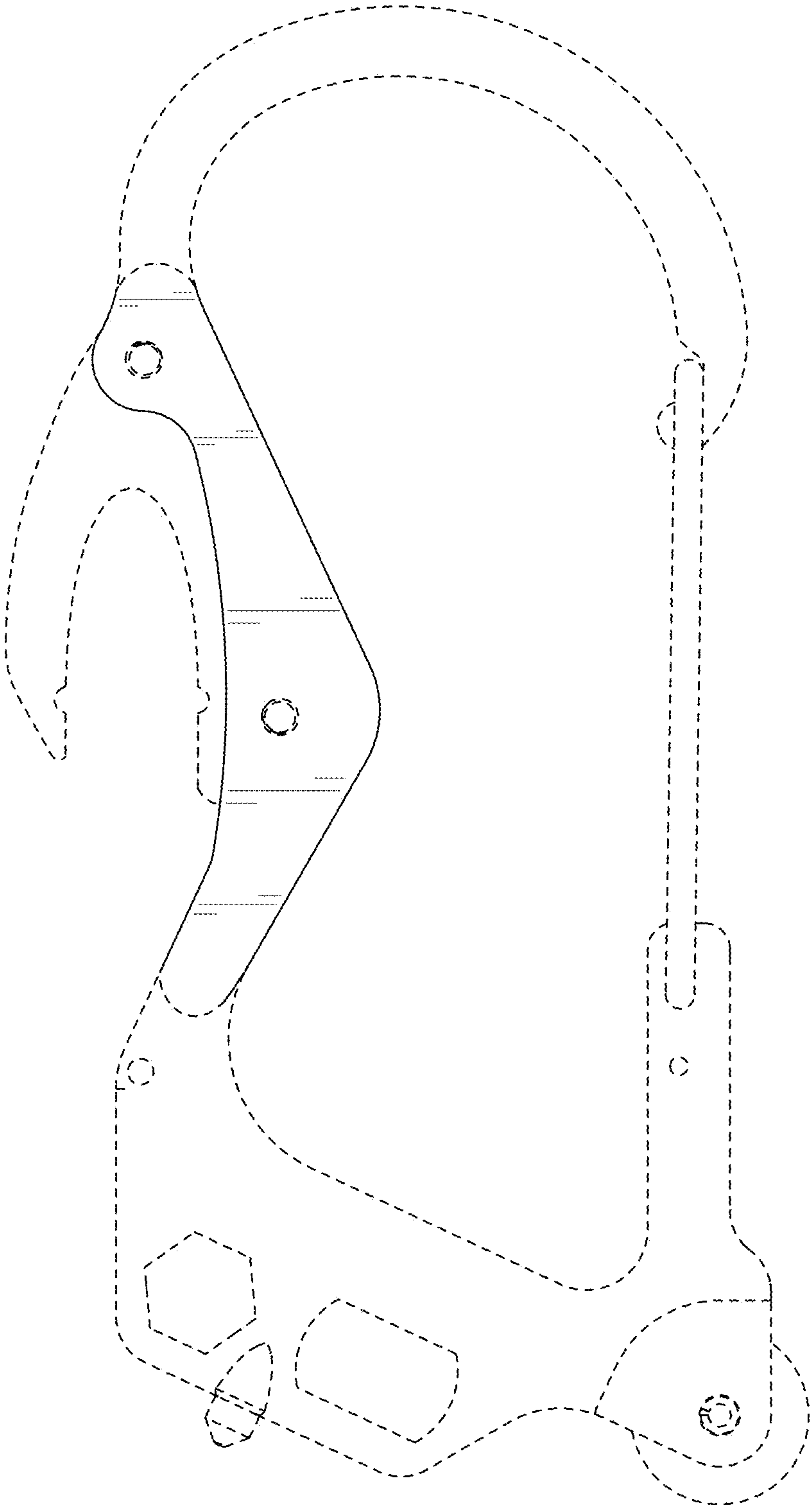

FIG. 12

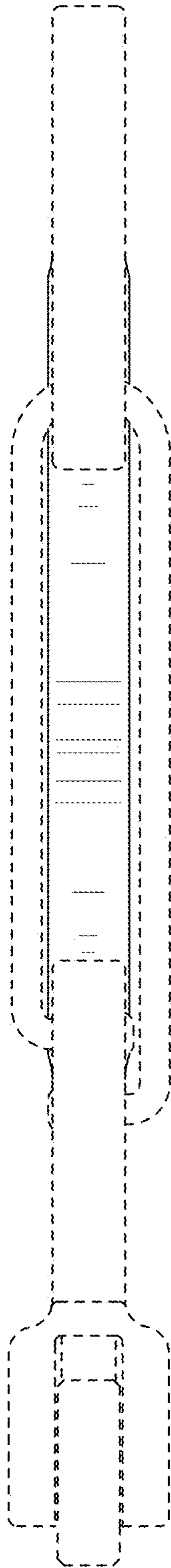

FIG. 13

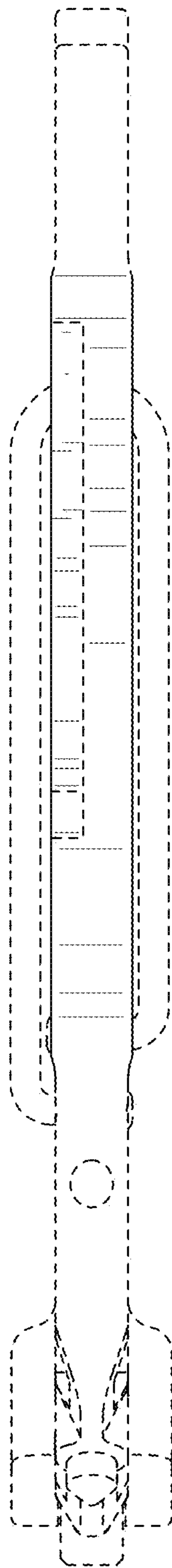

FIG. 14

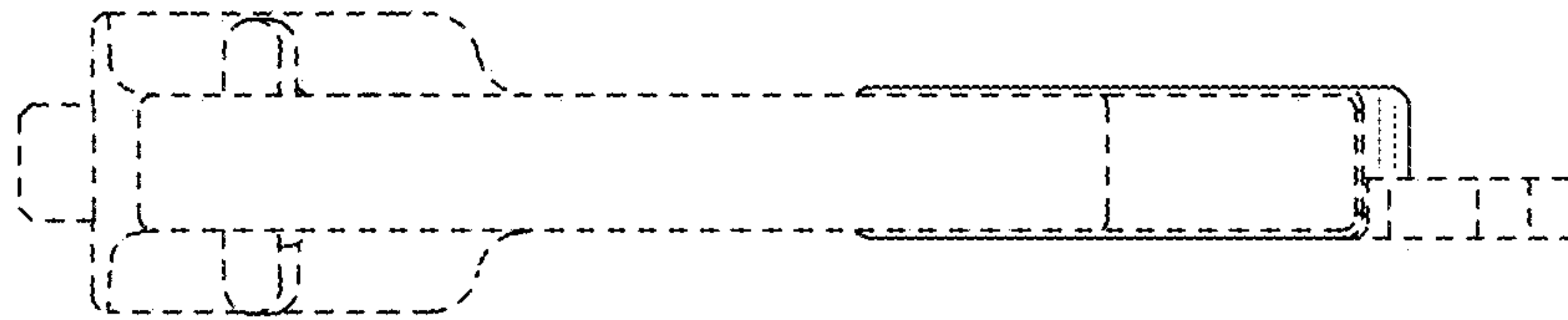

FIG. 15

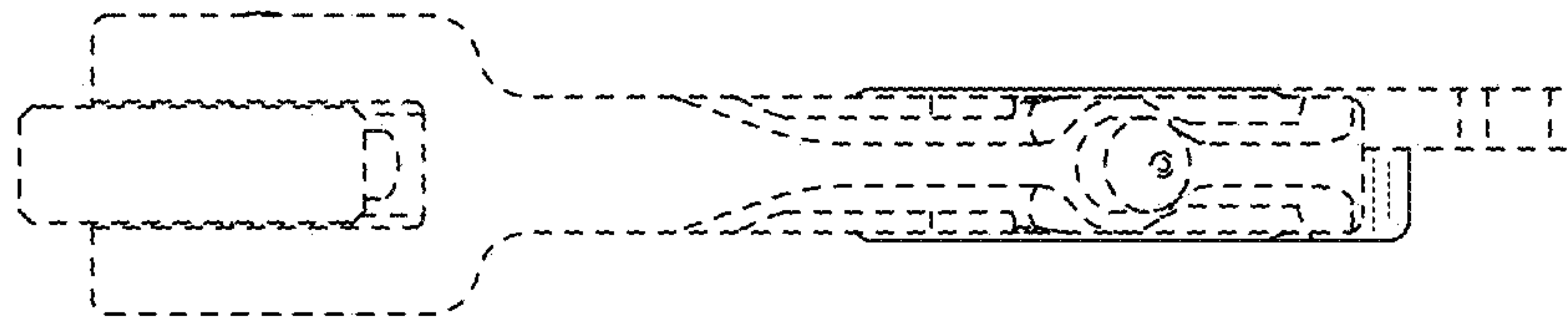

FIG. 16

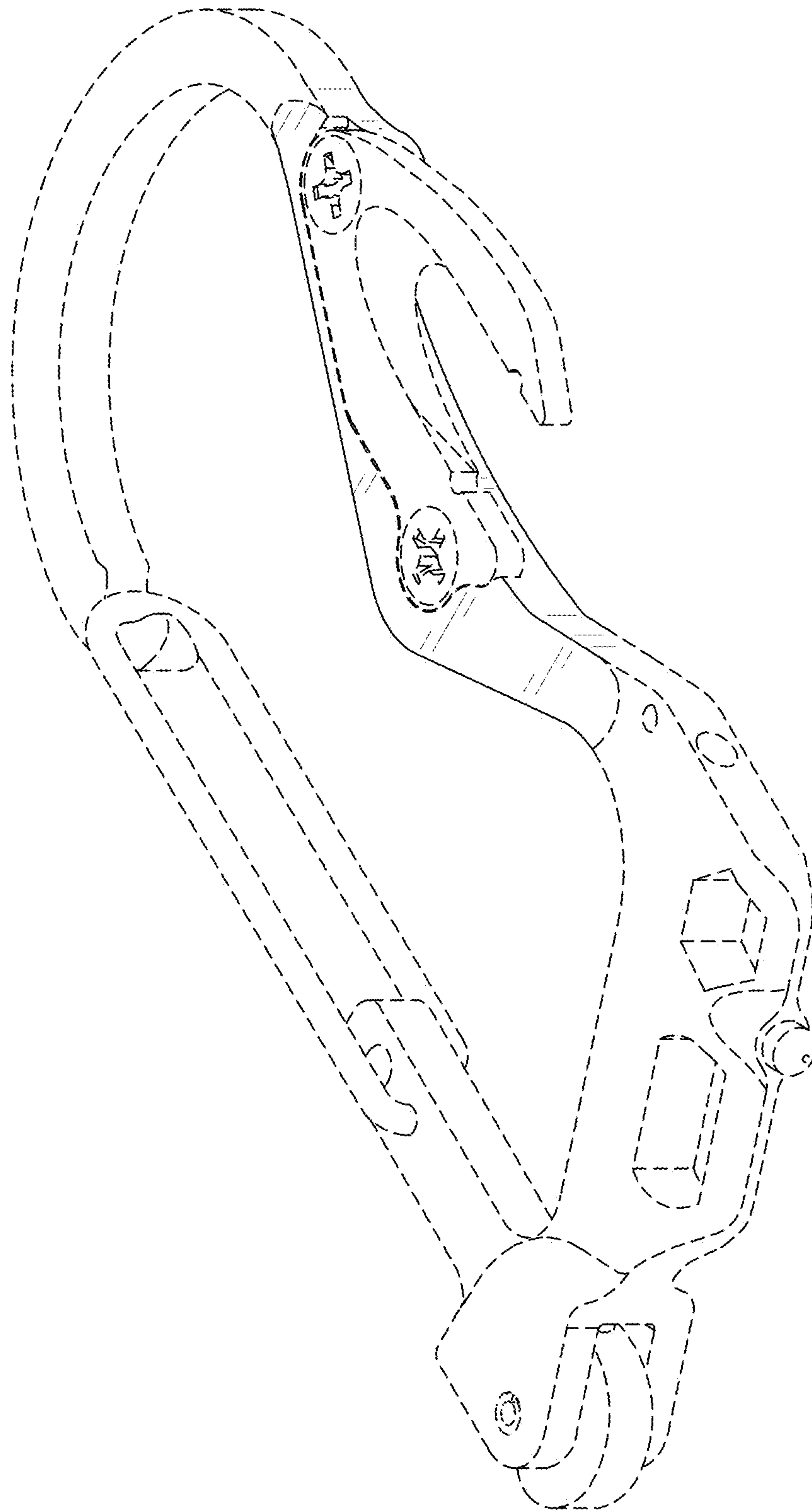

FIG. 17

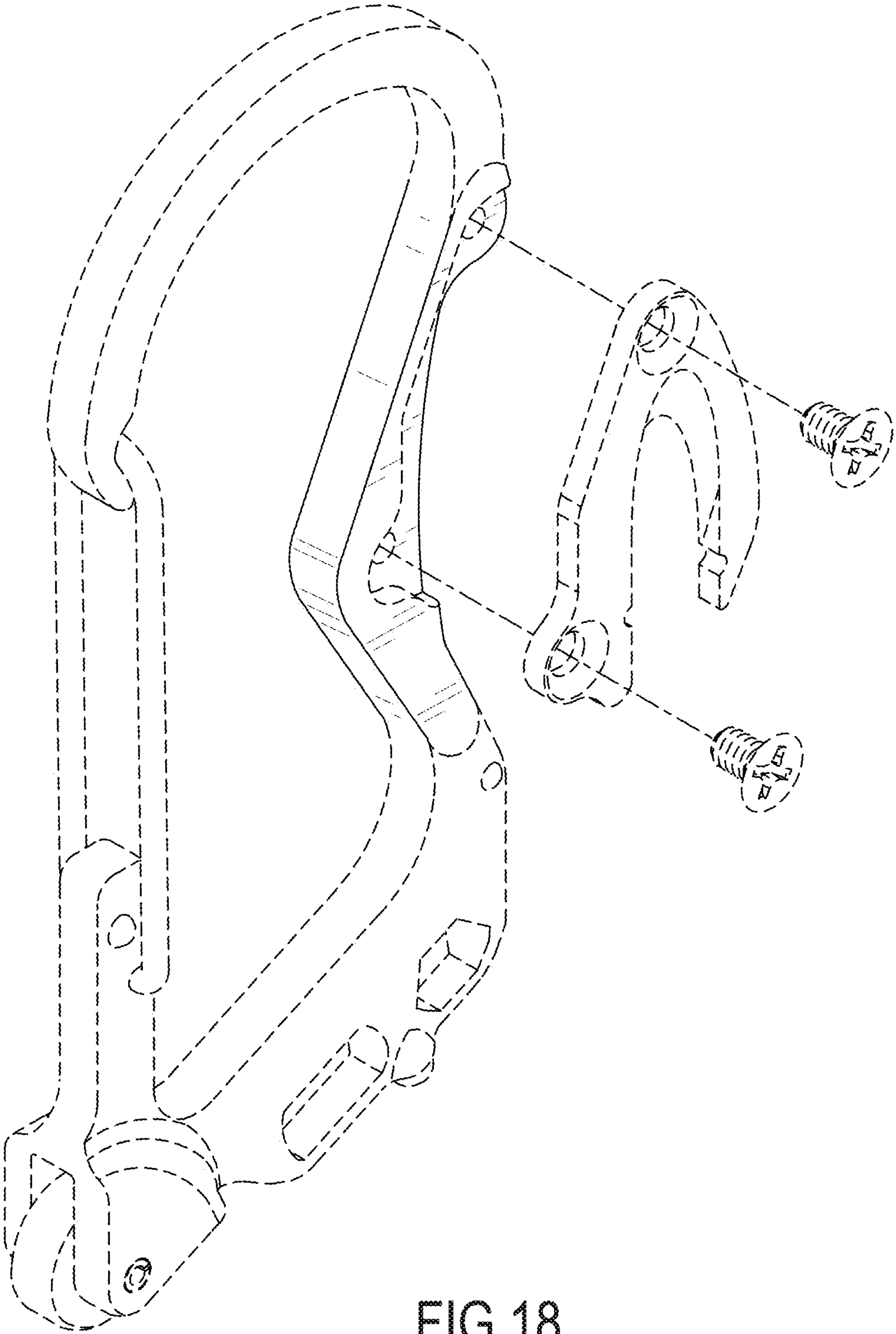

FIG.18