



US00D881561S

(12) **United States Design Patent**
He

(10) **Patent No.:** **US D881,561 S**

(45) **Date of Patent:** **** Apr. 21, 2020**

(54) **HANDBAG**

D866,175 S * 11/2019 Vaccarello D3/245

(71) Applicant: **Guangcheng He**, Henan Province (CN)

* cited by examiner

(72) Inventor: **Guangcheng He**, Henan Province (CN)

Primary Examiner — Holly H Baynham

(**) Term: **15 Years**

(74) *Attorney, Agent, or Firm* — Jie Yang; ZANIP

(21) Appl. No.: **29/713,750**

(57) **CLAIM**

(22) Filed: **Nov. 19, 2019**

The ornamental design for a handbag, as shown and described.

(51) **LOC (12) Cl.** **03-01**

DESCRIPTION

(52) **U.S. Cl.**

USPC **D3/245**

(58) **Field of Classification Search**

USPC D3/232–233, 240–243, 245–246, 283

CPC A45C 1/024; A45C 3/06

See application file for complete search history.

FIG. 1 is a front and top perspective view of a handbag, showing my new design;

FIG. 2 is a rear and bottom perspective view thereof;

FIG. 3 is a front elevational view thereof;

FIG. 4 is a rear elevational view thereof;

FIG. 5 is a left side elevational view thereof;

FIG. 6 is a right side elevational view thereof;

FIG. 7 is a top plan view thereof; and,

FIG. 8 is a bottom plan view thereof.

The broken lines in the figures illustrate portions of the handbag that form no part of the claimed design.

(56) **References Cited**

U.S. PATENT DOCUMENTS

D750,372 S * 3/2016 Slimane D3/232

D813,533 S 3/2018 de Haan

D813,539 S * 3/2018 Van Assche D3/283

D846,275 S * 4/2019 Barlier D3/245

1 Claim, 8 Drawing Sheets

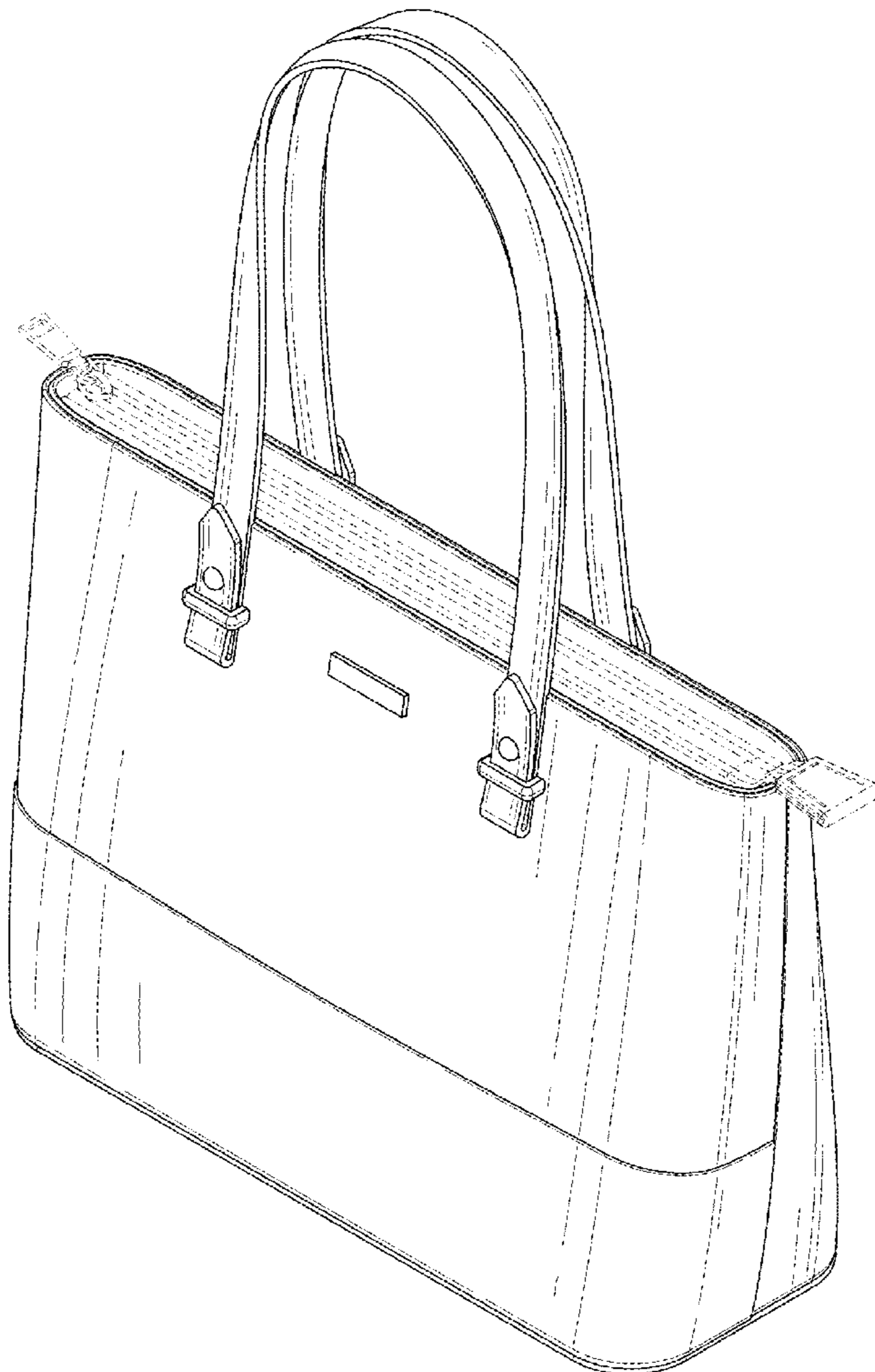

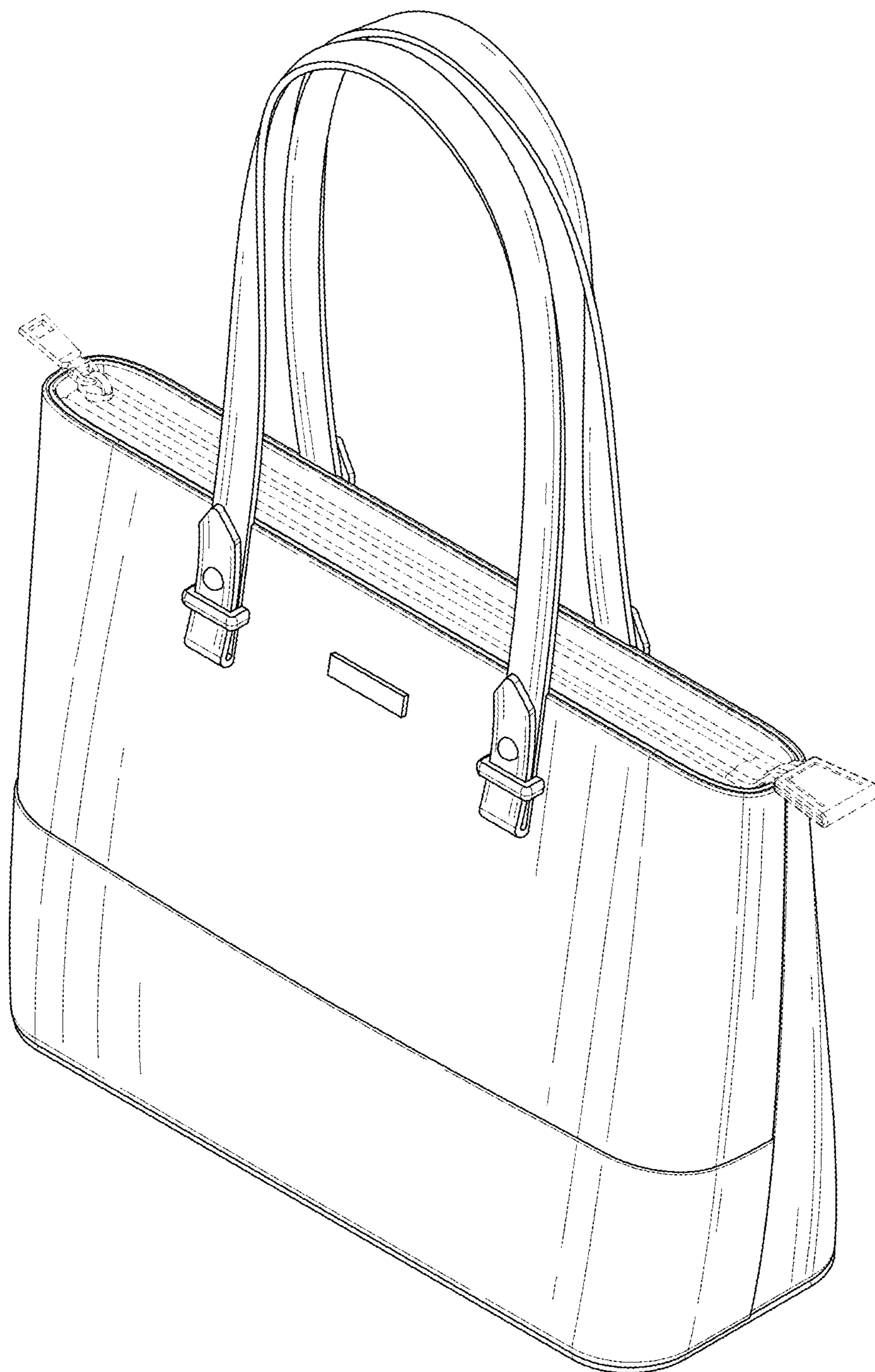

FIG. 1

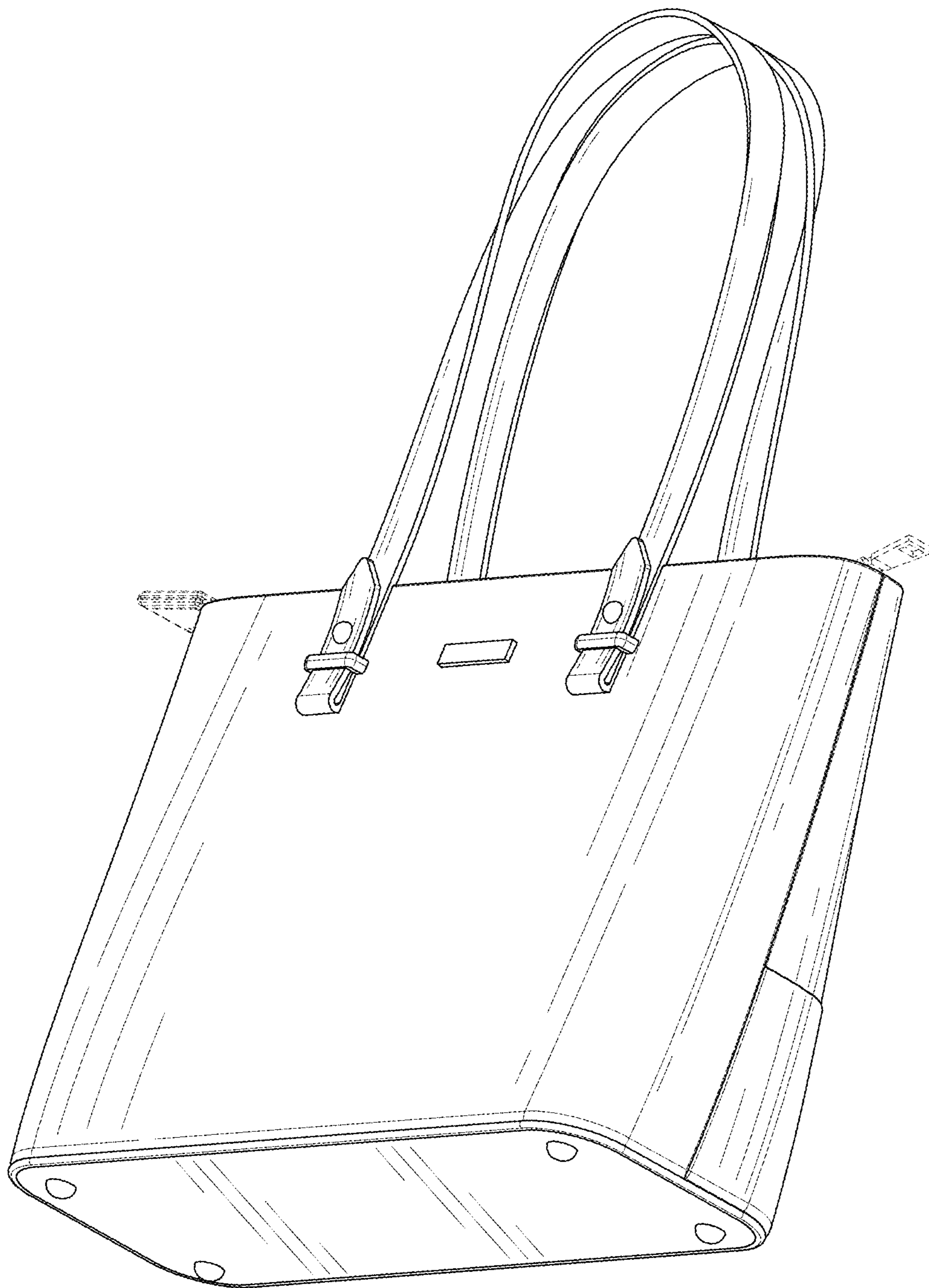

FIG. 2



FIG. 3



FIG. 4

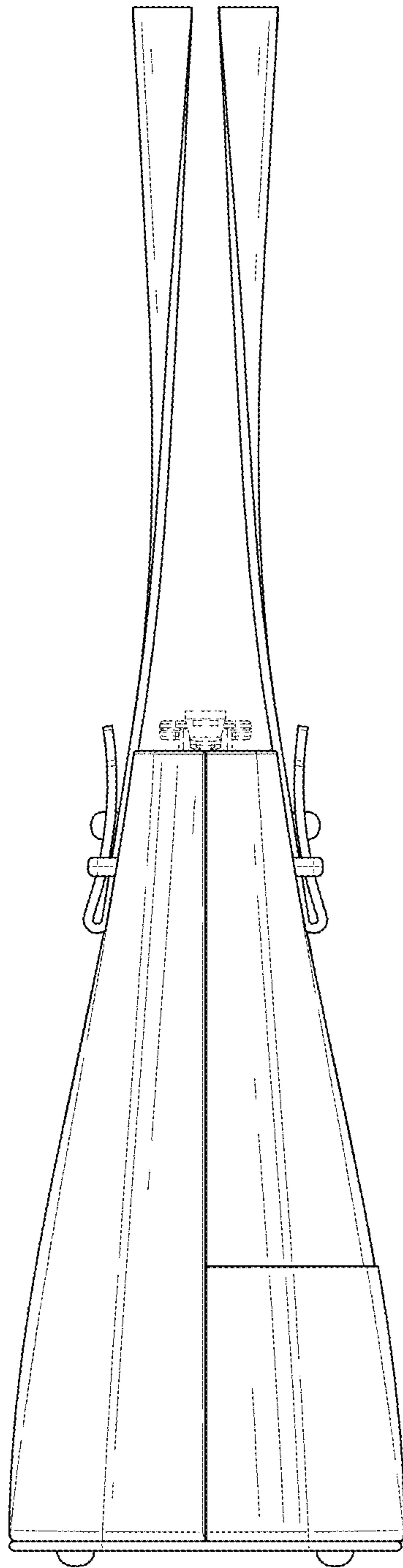

FIG. 5

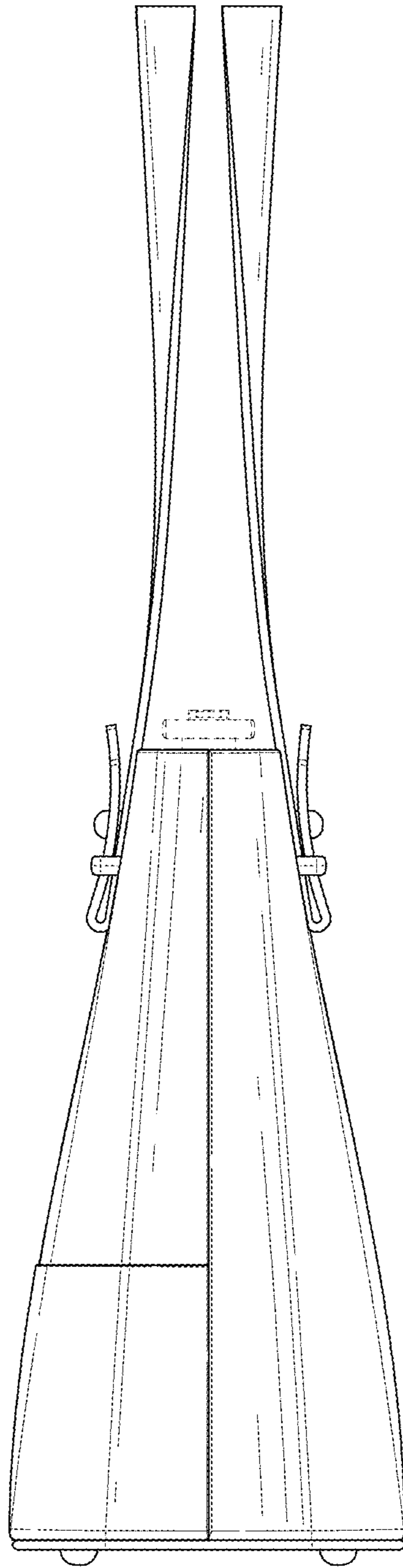

FIG. 6

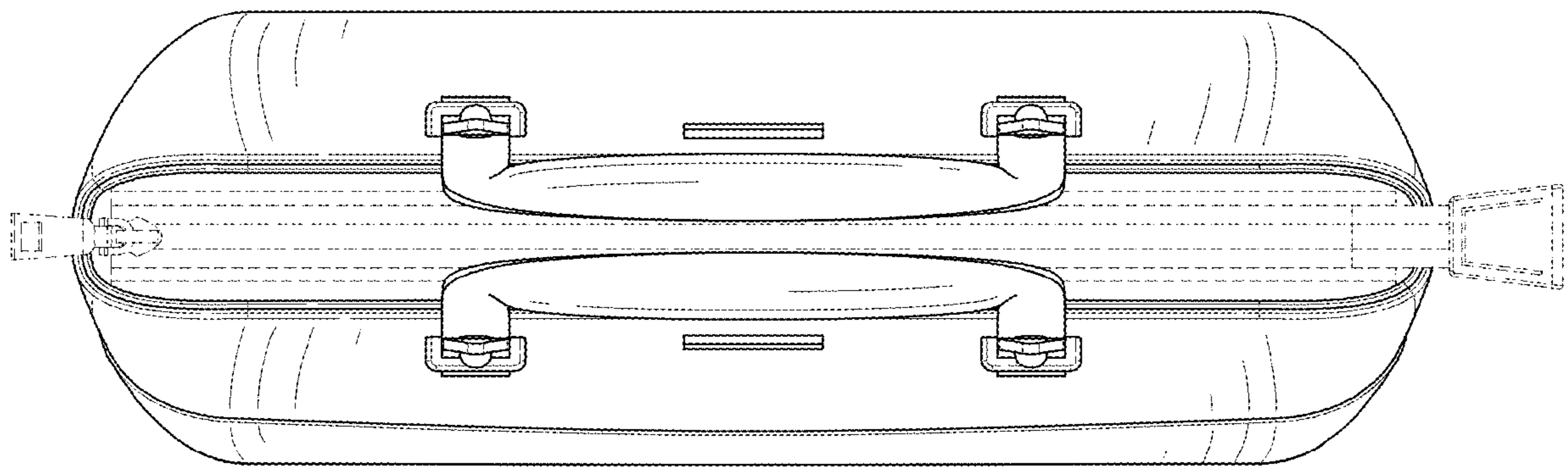

FIG. 7

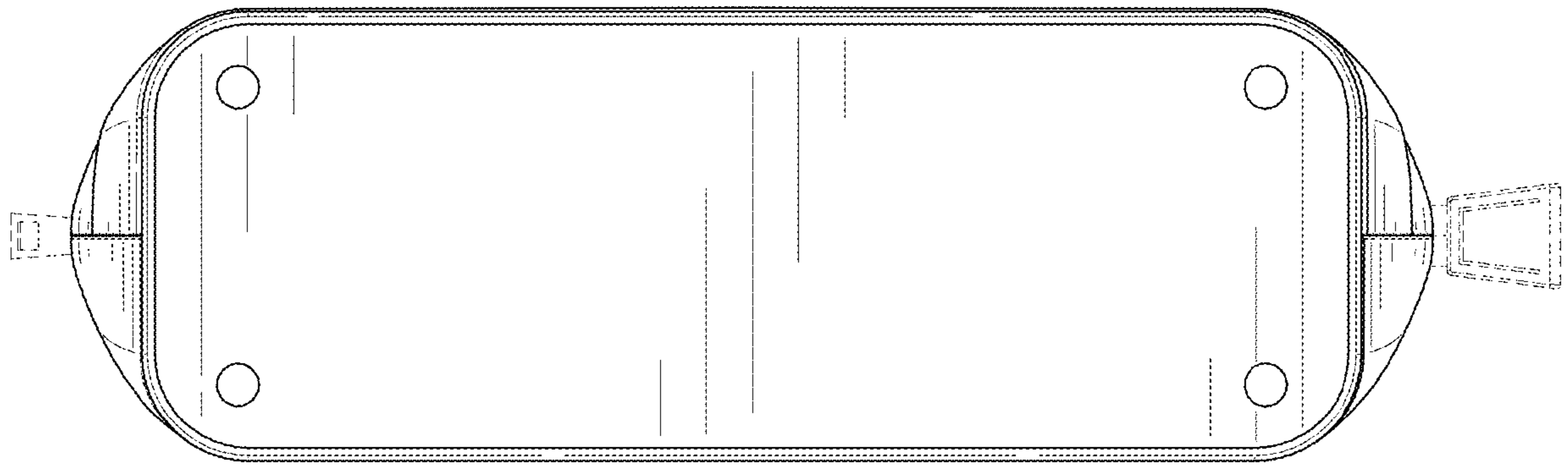

FIG. 8