



US00D881539S

(12) **United States Design Patent**  
**Lubart**

(10) **Patent No.:** **US D881,539 S**  
(45) **Date of Patent:** **\*\* Apr. 21, 2020**

(54) **FOOTWEAR TREAD**

- (71) Applicant: **Shoes For Crews, LLC**, Boca Raton, FL (US)
- (72) Inventor: **Randy N. Lubart**, Palm Beach Gardens, FL (US)
- (73) Assignee: **Shoes For Crews, LLC**, Boca Raton, FL (US)
- (\*\*) Term: **15 Years**
- (21) Appl. No.: **29/660,891**
- (22) Filed: **Aug. 23, 2018**
- (51) **LOC (12) Cl.** ..... **02-04**
- (52) **U.S. Cl.**  
USPC ..... **D2/957**; D2/951; D2/960
- (58) **Field of Classification Search**  
USPC ..... D2/902, 906, 908, 916, 918, 925, D2/946-962, 977; 36/1, 1.5, 3 B, 22 R, 36/24.5, 25 R, 28, 32 R, 34 R, 59 C, 36/67 A, 101-107, 114-116, 117.3, 117.4, 36/124-136; D12/544; D22/108  
CPC ..... A43B 13/00; A43B 13/02; A43B 13/023; A43B 13/026; A43B 13/04; A43B 13/08; A43B 13/10; A43B 13/12; A43B 13/14; A43B 13/141; A43B 13/143; A43B 13/16; A43B 13/18; A43B 13/181; A43B 13/187; A43B 13/189; A43B 13/20; A43B 13/22; A43B 13/223; A43B 13/24; A43B 13/28; A43B 13/30; A43B 13/32; A43B 13/34; A43B 13/36  
See application file for complete search history.

(56) **References Cited**

**U.S. PATENT DOCUMENTS**

- D288,027 S \* 2/1987 Tonkel ..... 36/32 R
- D294,423 S \* 3/1988 Zuidema ..... D2/954
- D326,179 S \* 5/1992 Walker ..... D2/954
- D388,594 S \* 1/1998 Turner ..... D2/951

(Continued)

**OTHER PUBLICATIONS**

New Balance 420v3, ShoesForCrews.com, [online], [site visited Dec. 4, 2019]. <URL: [https://www.shoesforcrews.com/sfc3/index.cfm?changeWebsite=US\\_en&route=c\\_store.viewDetailsOfProduct&partnumber=28172](https://www.shoesforcrews.com/sfc3/index.cfm?changeWebsite=US_en&route=c_store.viewDetailsOfProduct&partnumber=28172)> (Year: 2019).\*

(Continued)

*Primary Examiner* — T Chase Nelson  
*Assistant Examiner* — Jonathan J. Han

(74) *Attorney, Agent, or Firm* — McHale & Slavin, P.A.

(57) **CLAIM**

The ornamental design for a footwear tread, as shown and described.

**DESCRIPTION**

FIG. 1 is a perspective top left view of the footwear tread of the present invention;  
 FIG. 2 is a top view thereof;  
 FIG. 3 is a left side view thereof;  
 FIG. 4 is a right side view thereof;  
 FIG. 5 is a front view thereof;  
 FIG. 6 is a rear view thereof;  
 FIG. 7 is a section view thereof taken along lines 7-7 of FIG. 2; and,  
 FIG. 8 is a perspective view thereof, illustrating the footwear tread positioned on a piece of footwear.  
 The broken away symbols in the drawings at the perimeter and bottom edges indicate that any portion of the article beyond what is shown forms no part of the claimed design. The broken lines depict environmental structure in the form of footwear, a footwear outsole, and other footwear treads that form no part of the claimed design. Additionally, the broken lines in the FIG. 2 view depict the location of the cross-section of the FIG. 7 view and also form no part of the claimed design.

**1 Claim, 5 Drawing Sheets**

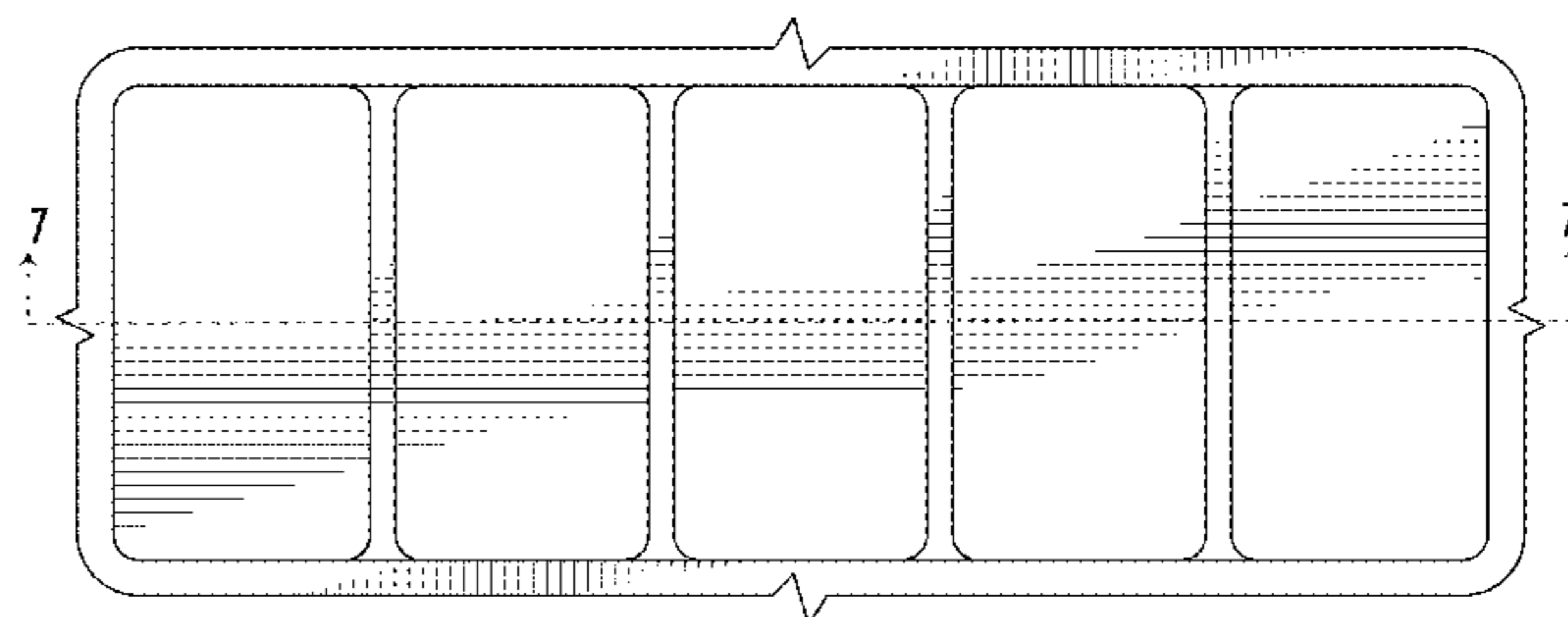
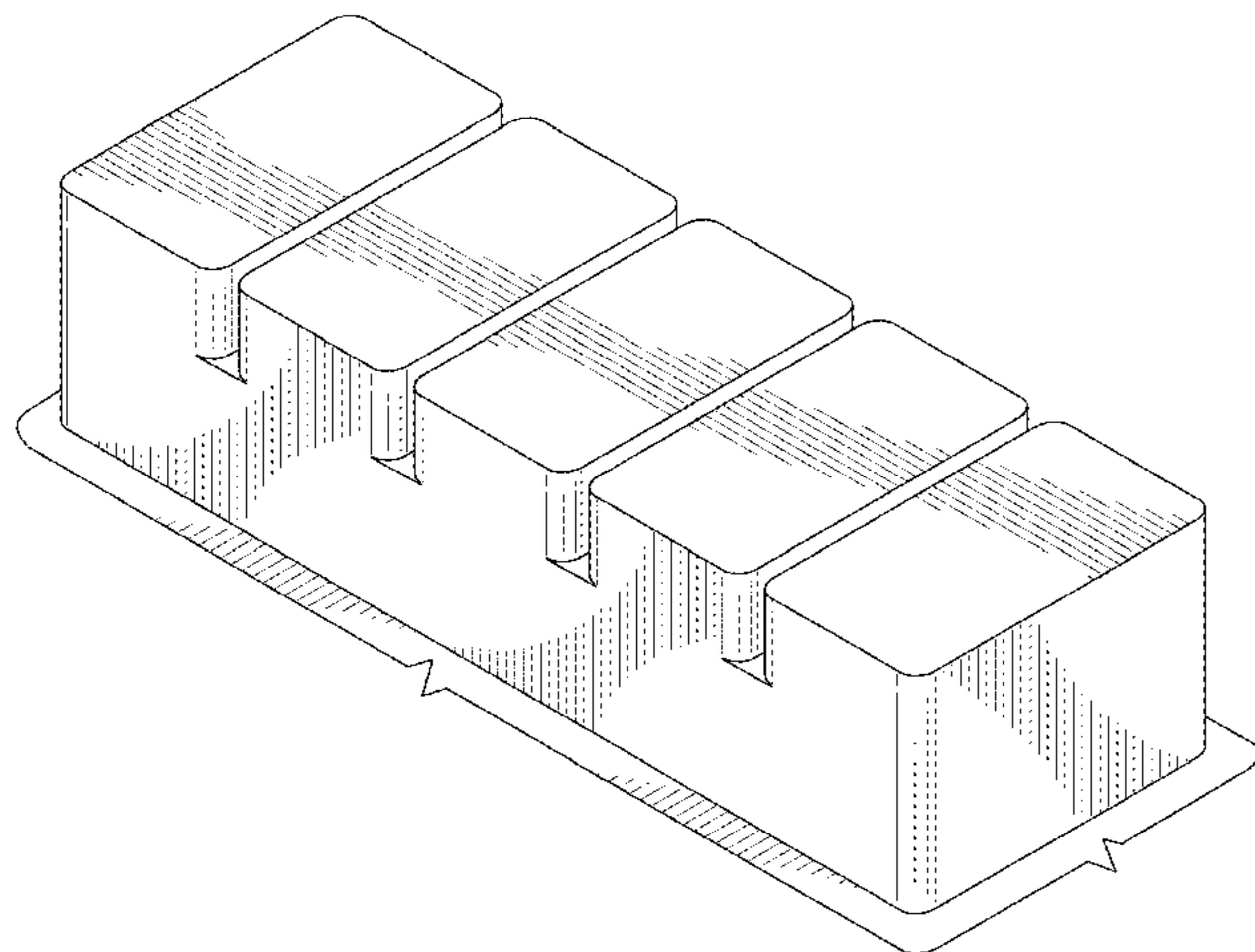

(56)

**References Cited**

## U.S. PATENT DOCUMENTS

D390,348	S *	2/1998	Meyer	.....	D2/957
D401,395	S *	11/1998	Clarke	.....	D2/953
D424,793	S *	5/2000	Lubart	.....	D2/951
D473,042	S *	4/2003	Wilson	.....	D2/953
D478,717	S *	8/2003	Adams	.....	D2/951
D520,220	S *	5/2006	Morgan	.....	D2/954
D521,715	S *	5/2006	Lotti	.....	D2/957
D544,185	S *	6/2007	Lupo	.....	D2/951
7,313,875	B2 *	1/2008	Morgan	.....	A43B 13/145 36/25 R
D642,362	S *	8/2011	Miner	.....	D2/951
D697,296	S *	1/2014	Loyley	.....	D2/951
8,671,592	B2 *	3/2014	Dojan	.....	A43B 13/122 36/103
D711,813	S *	8/2014	Wang	.....	D12/565
D723,453	S *	3/2015	Knispel	.....	D12/563
D748,385	S *	2/2016	Birkinhead	.....	D2/951
D755,490	S *	5/2016	Nakano	.....	D2/951
D797,425	S *	9/2017	Wegener	.....	D2/951
D801,660	S *	11/2017	Young	.....	D2/960
D812,883	S *	3/2018	Gibson	.....	D2/960
D833,725	S *	11/2018	Hernandez	.....	D2/960
D844,306	S *	4/2019	Hobson	.....	D2/951
D851,885	S *	6/2019	Sebastian	.....	D2/960
2012/0311887	A1 *	12/2012	Wong	.....	A43B 7/147 36/28

## OTHER PUBLICATIONS

What is the difference between oil-resistant and slip-resistant shoes?, ShoesTracker.com, Last Updated May 14, 2019 by Lilly Derrah, [online], [site visited Dec. 4, 2019]. <URL: <https://shoestracker.com/oil-resistant-vs-slip-resistant/>> (Year: 2019).\*

\* cited by examiner

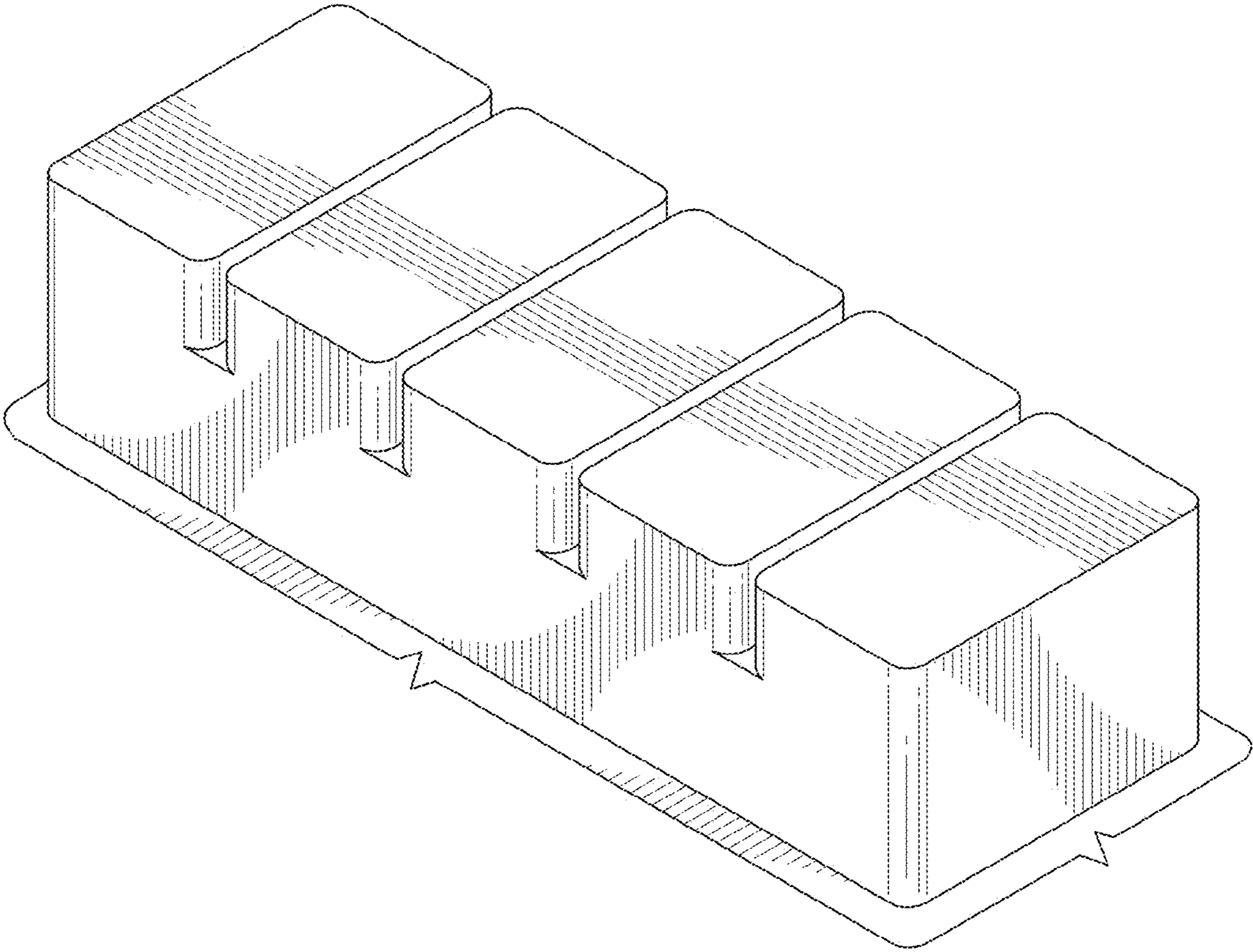

FIG. 1

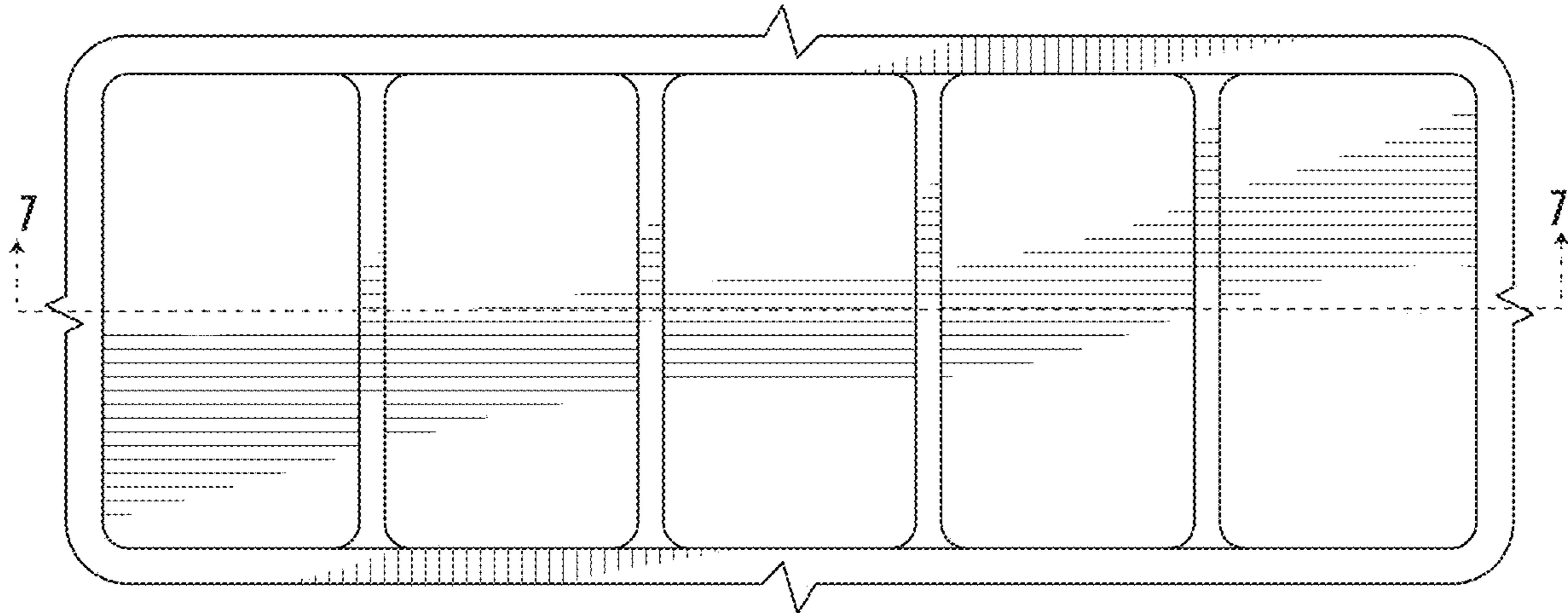

FIG. 2

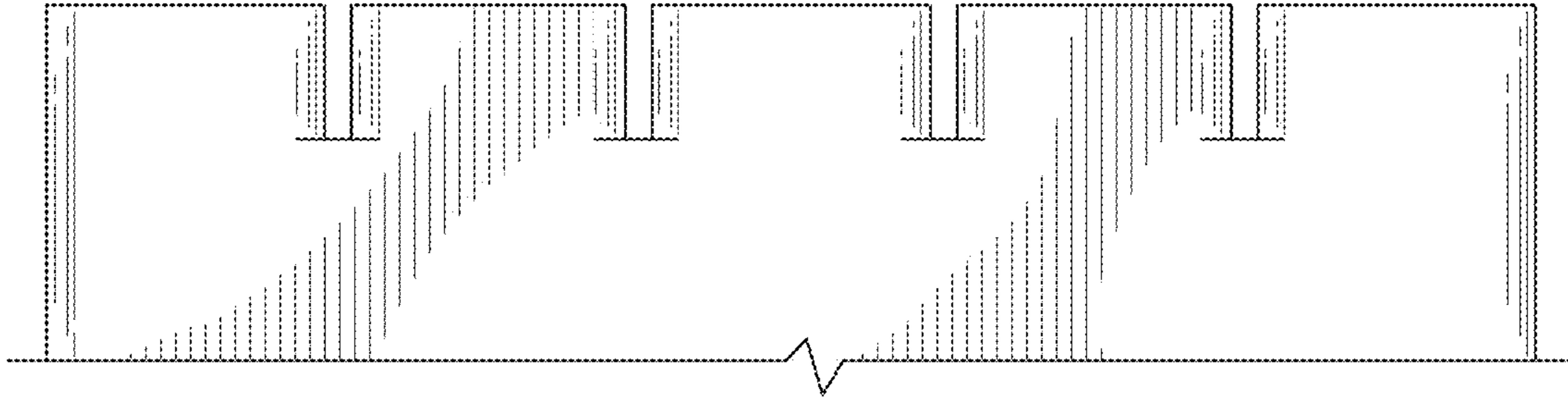

FIG. 3

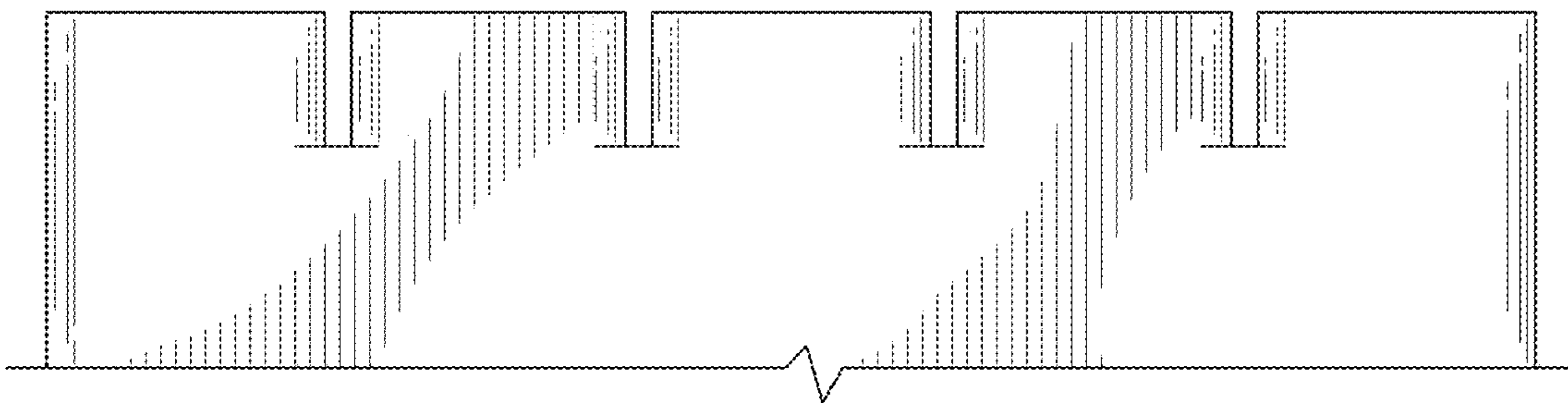

FIG. 4

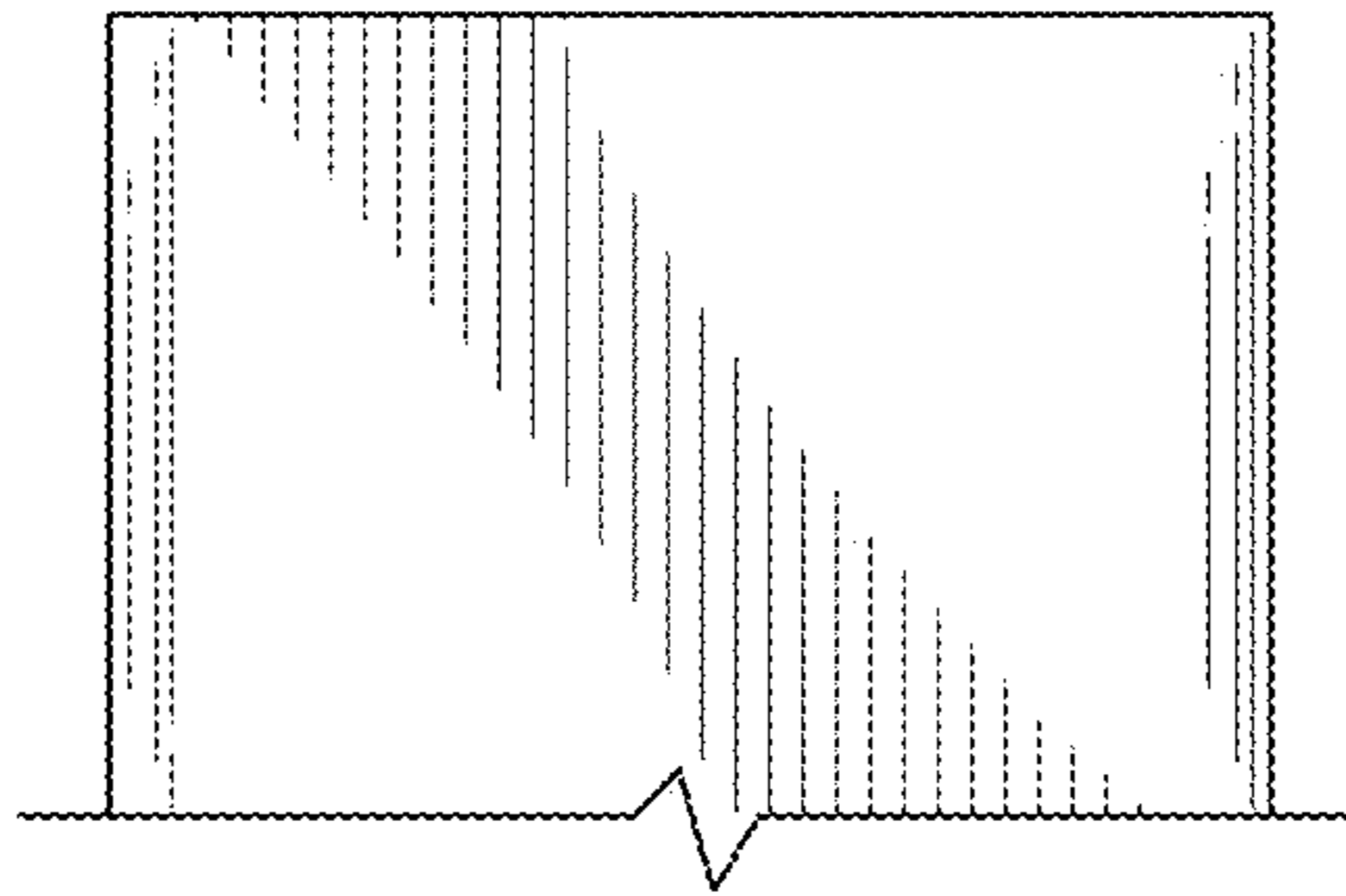

FIG. 5

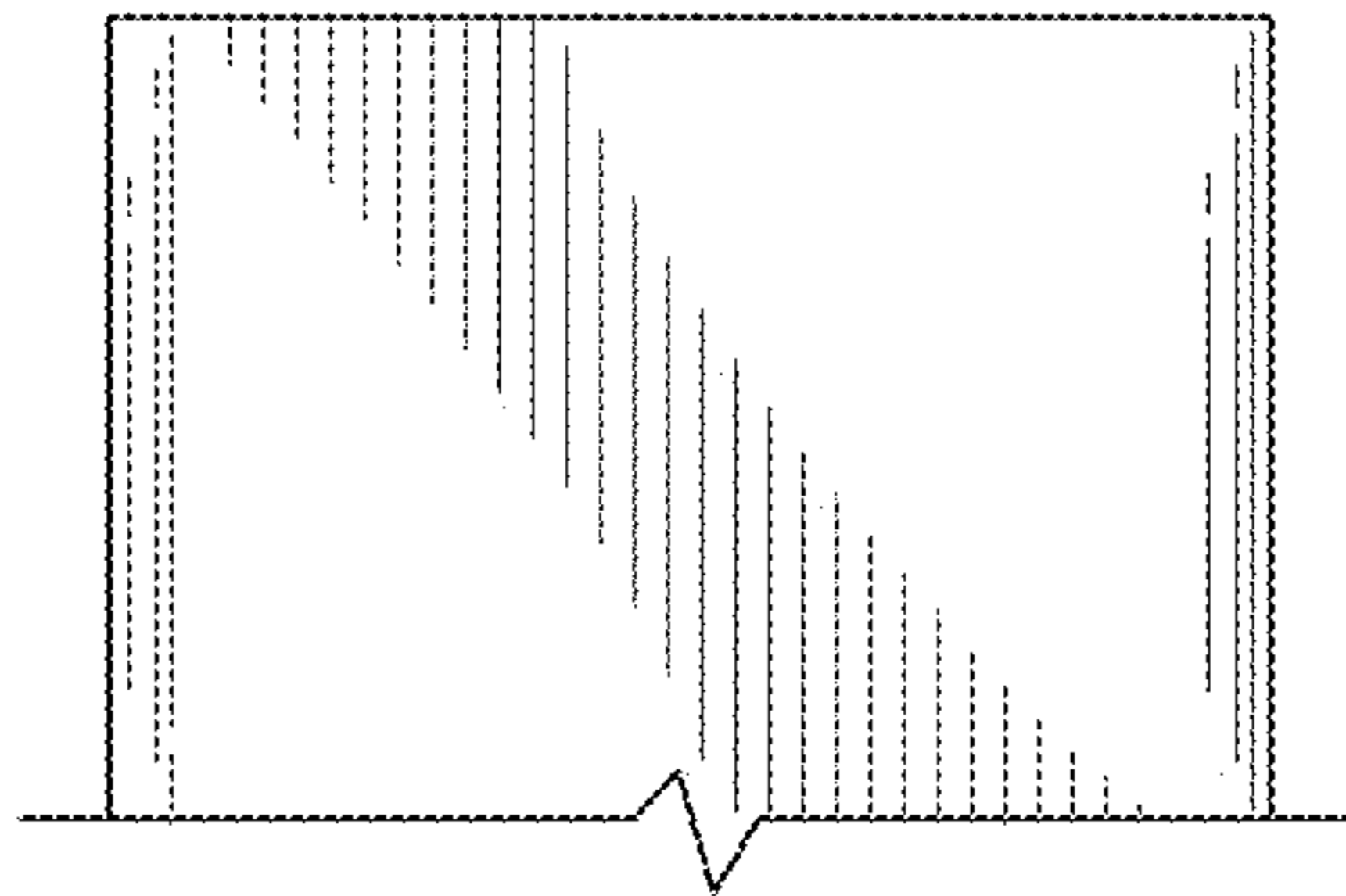

FIG. 6

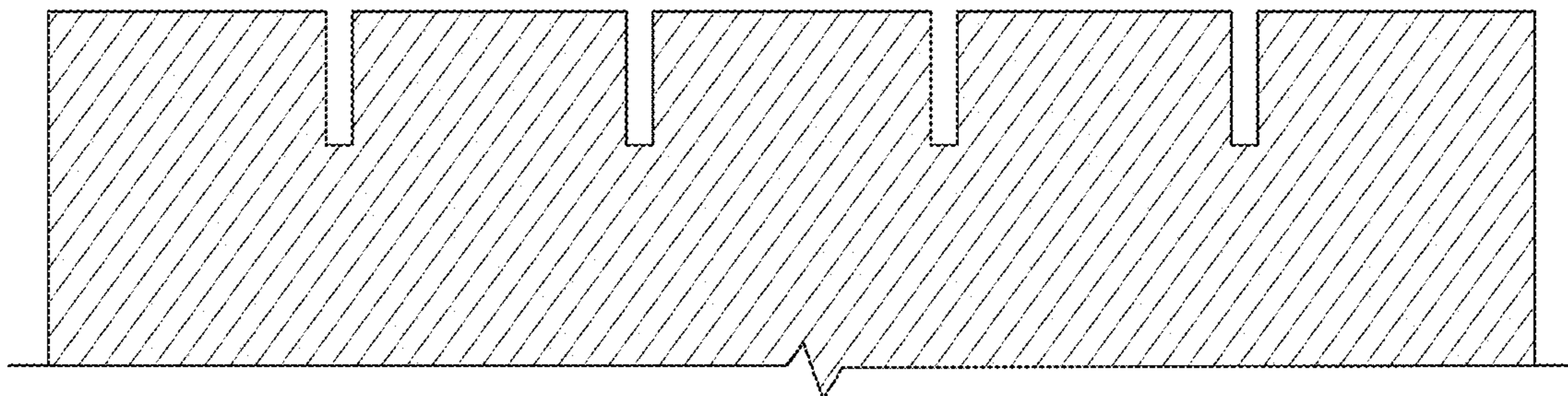

FIG. 7

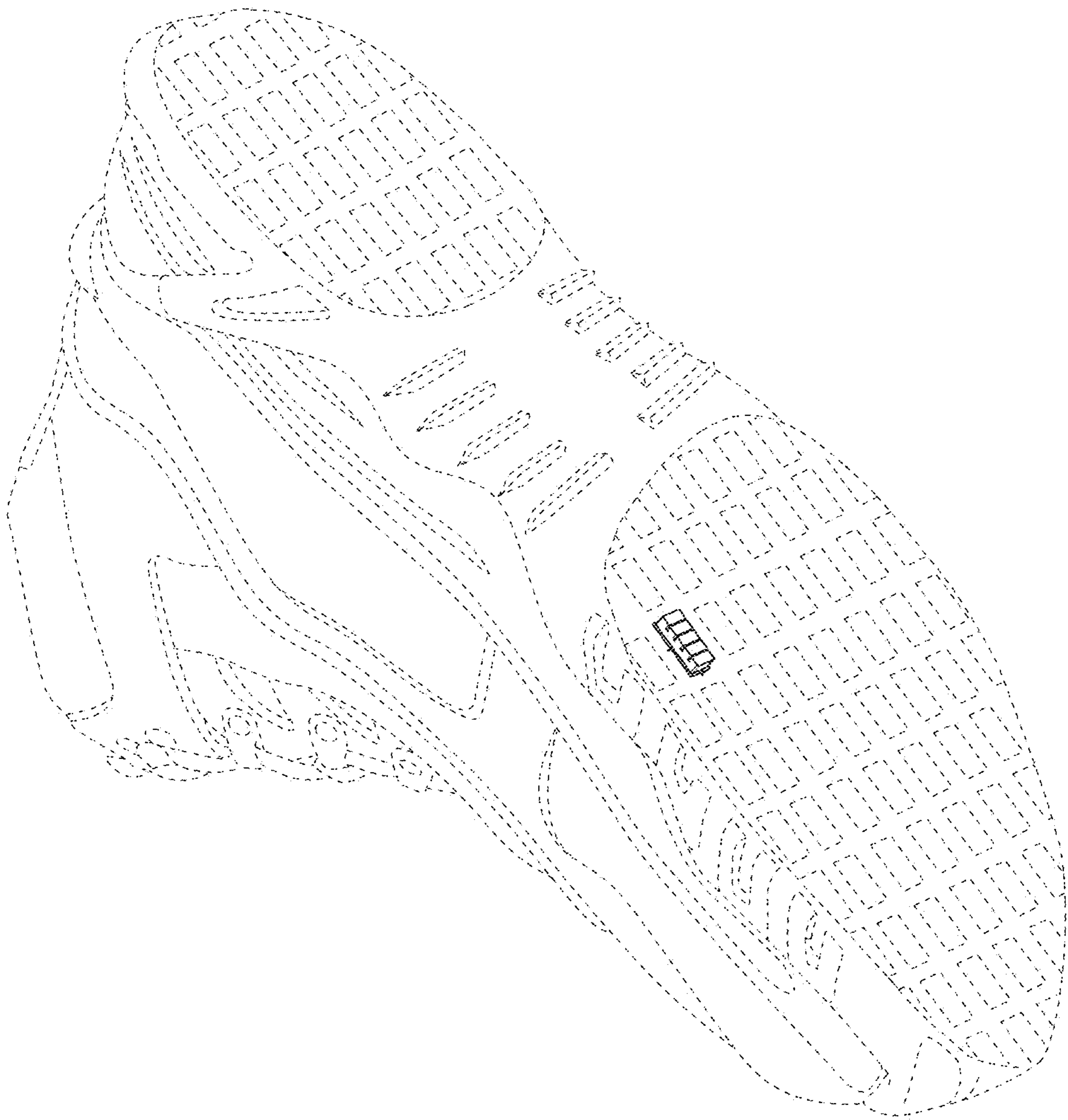

FIG. 8