



US00D881529S

(12) **United States Design Patent**  
**Buonocore**

(10) **Patent No.:** **US D881,529 S**  
(45) **Date of Patent:** **\*\* Apr. 21, 2020**

(54) **LADYBUG SWEATSHIRT HOOD**  
(71) Applicant: **Ontel Products Corporation**, Fairfield, NJ (US)  
(72) Inventor: **Carly Buonocore**, Lincoln Park, NJ (US)  
(73) Assignee: **ONTEL PRODUCTS CORPORATION**, Fairfield, NJ (US)  
(\*\*) Term: **15 Years**

(21) Appl. No.: **29/680,298**  
(22) Filed: **Feb. 14, 2019**  
(51) **LOC (12) Cl.** ..... **02-02**  
(52) **U.S. Cl.**  
USPC ..... **D2/831; D2/878**  
(58) **Field of Classification Search**  
USPC ..... D2/728, 823, 824, 825, 826, 828, 831, D2/865, 866, 867, 870, 874, 877, 878, D2/880, 881, 887, 891, 892, 895; D5/13, D5/14, 20, 63, 64, 65; D6/598; D21/659, 660; D29/102, 108  
CPC ..... A41D 3/02; A41D 11/00; A41D 15/005; A41D 15/04; A41D 2200/20; A41D 27/08; A42B 1/00; A42B 1/006; A42B 1/04; A42B 1/041; A42B 1/045; A42B 1/046; A42B 1/048; A42B 7/00; A47G 9/1045; A63H 3/00  
See application file for complete search history.

(56) **References Cited**  
U.S. PATENT DOCUMENTS  
885,802 A \* 4/1908 Sterrick ..... A41D 13/11 2/206  
4,543,669 A 10/1985 Katz  
D285,815 S \* 9/1986 Finn ..... D2/741  
D409,430 S \* 5/1999 Bear ..... D21/650

6,216,642 B1 \* 4/2001 Hung ..... A01K 13/006 119/850  
D505,290 S \* 5/2005 Bourget ..... D21/650  
6,922,848 B1 \* 8/2005 Stanley ..... A41D 1/00 2/244

(Continued)

*Primary Examiner* — Jasmine Mlinarcik  
(74) *Attorney, Agent, or Firm* — Dickinson Wright PLLC

(57) **CLAIM**  
I claim the ornamental design for a ladybug sweatshirt hood, as shown and described.

**DESCRIPTION**

FIG. 1 is a front perspective view of a ladybug sweatshirt hood;  
FIG. 2 is a front view of the ladybug sweatshirt hood of FIG. 1;  
FIG. 3 is a rear view of the ladybug sweatshirt hood of FIG. 1;  
FIG. 4 is a top view of the ladybug sweatshirt hood of FIG. 1;  
FIG. 5 is a right side view of the ladybug sweatshirt hood of FIG. 1;  
FIG. 6 is a left side view of the ladybug sweatshirt hood of FIG. 1;  
FIG. 7 is a front view of the ladybug sweatshirt hood of FIG. 1 in a laid-flat position with a zipper in an open position; and,  
FIG. 8 is a front view of the ladybug sweatshirt hood of FIG. 1 with a zipper in an open position.  
The zipper follows the curvature of the ladybug sweatshirt hood. The facial features are an applied motif that follows the curvature of the ladybug sweatshirt hood. The dash-dot-dash broken line defines the bounds of the claim and forms no part of the claimed design. The even-length broken lines along the hood portion of the ladybug sweatshirt hood depict features that form no part of the claimed design. The even-length broken lines beyond the boundary line depicts portions of the ladybug sweatshirt hood that form no part of the claimed design.

**1 Claim, 7 Drawing Sheets**

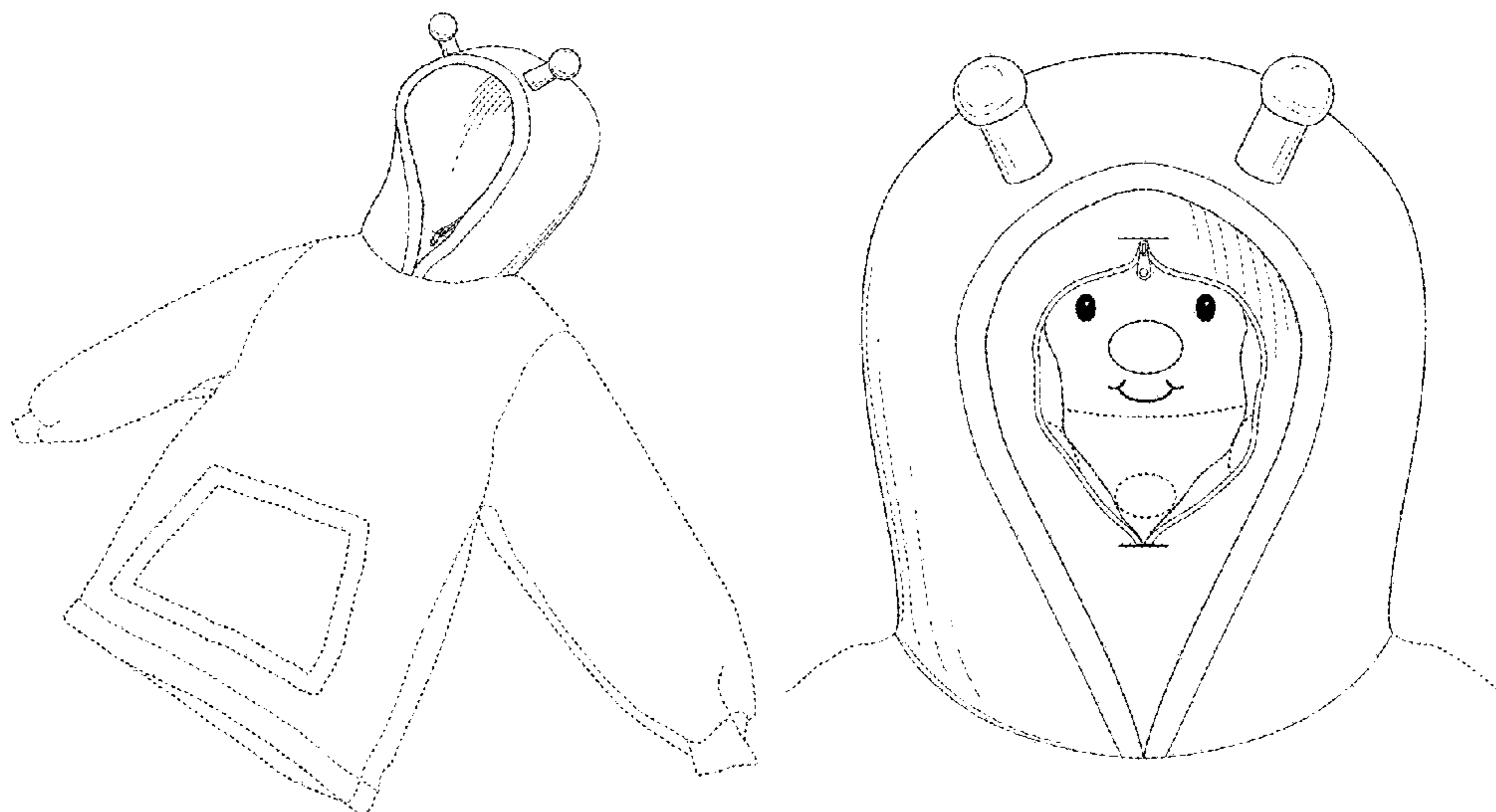

(56)

**References Cited**

U.S. PATENT DOCUMENTS

D551,429 S *	9/2007	Wager .....	D2/831
D566,929 S *	4/2008	Huang .....	D2/867
D597,716 S *	8/2009	Wen .....	D21/659
D672,534 S *	12/2012	Smith .....	D2/878
D708,822 S *	7/2014	Douglas .....	D2/880
D712,121 S *	9/2014	Leon .....	D2/870
9,936,746 B1	4/2018	Park	
2008/0115254 A1	5/2008	Galkov	
2014/0237700 A1	8/2014	Albert	
2015/0121604 A1	5/2015	Lee et al.	
2018/0132551 A1	5/2018	Holder, III	
2018/0352879 A1 *	12/2018	Goulina .....	A41D 15/04

\* cited by examiner

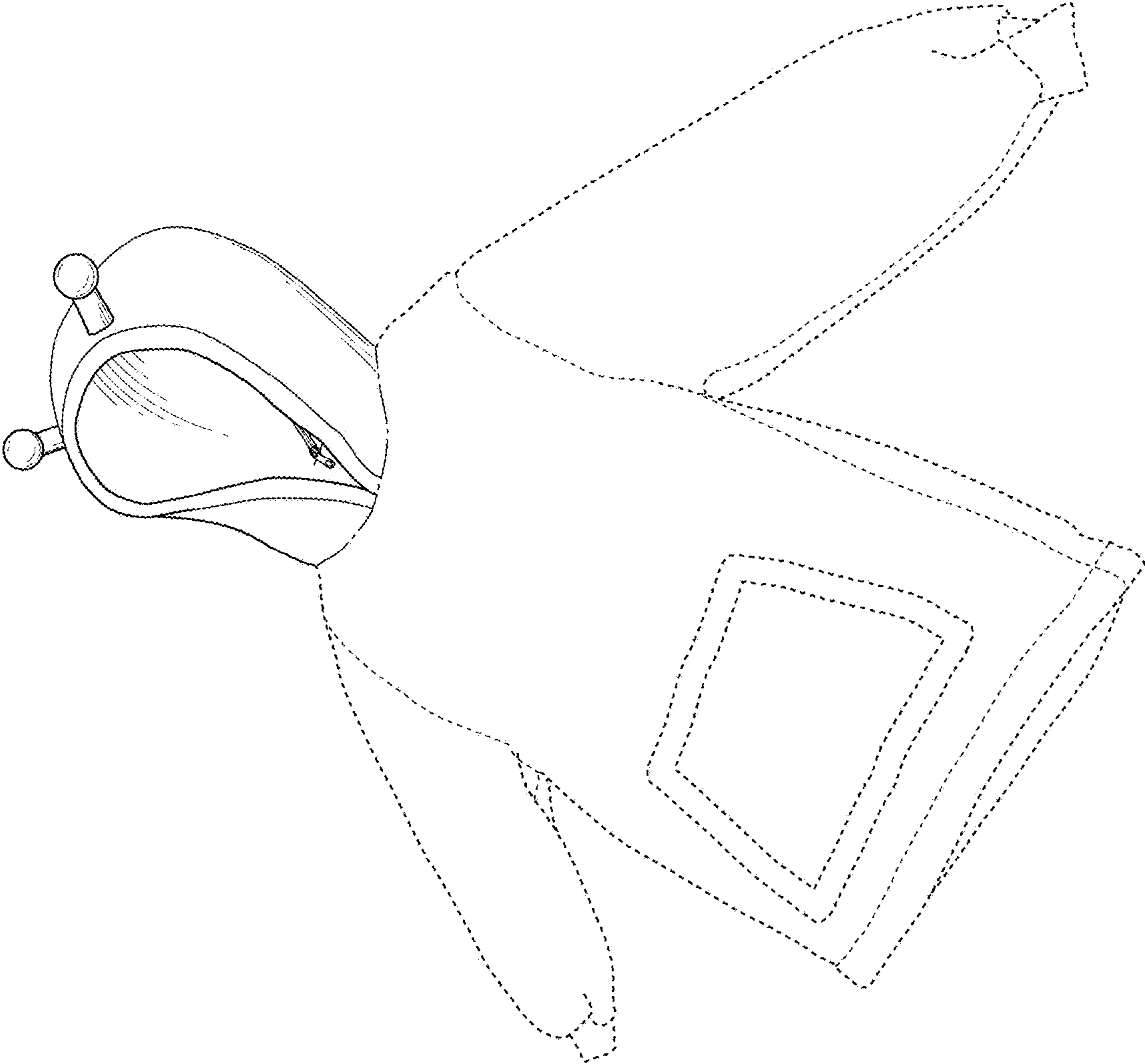

FIG. 1

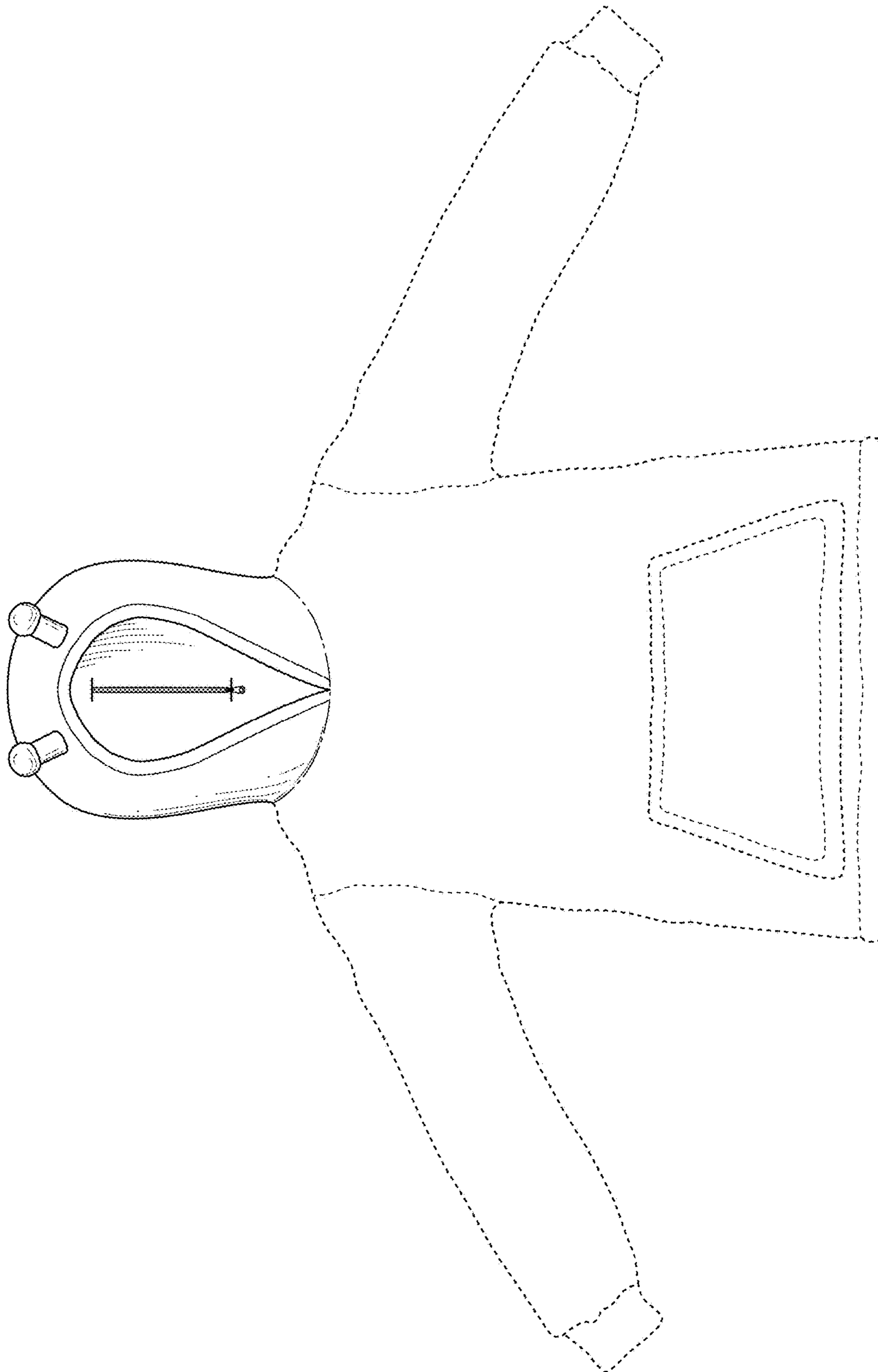

FIG. 2

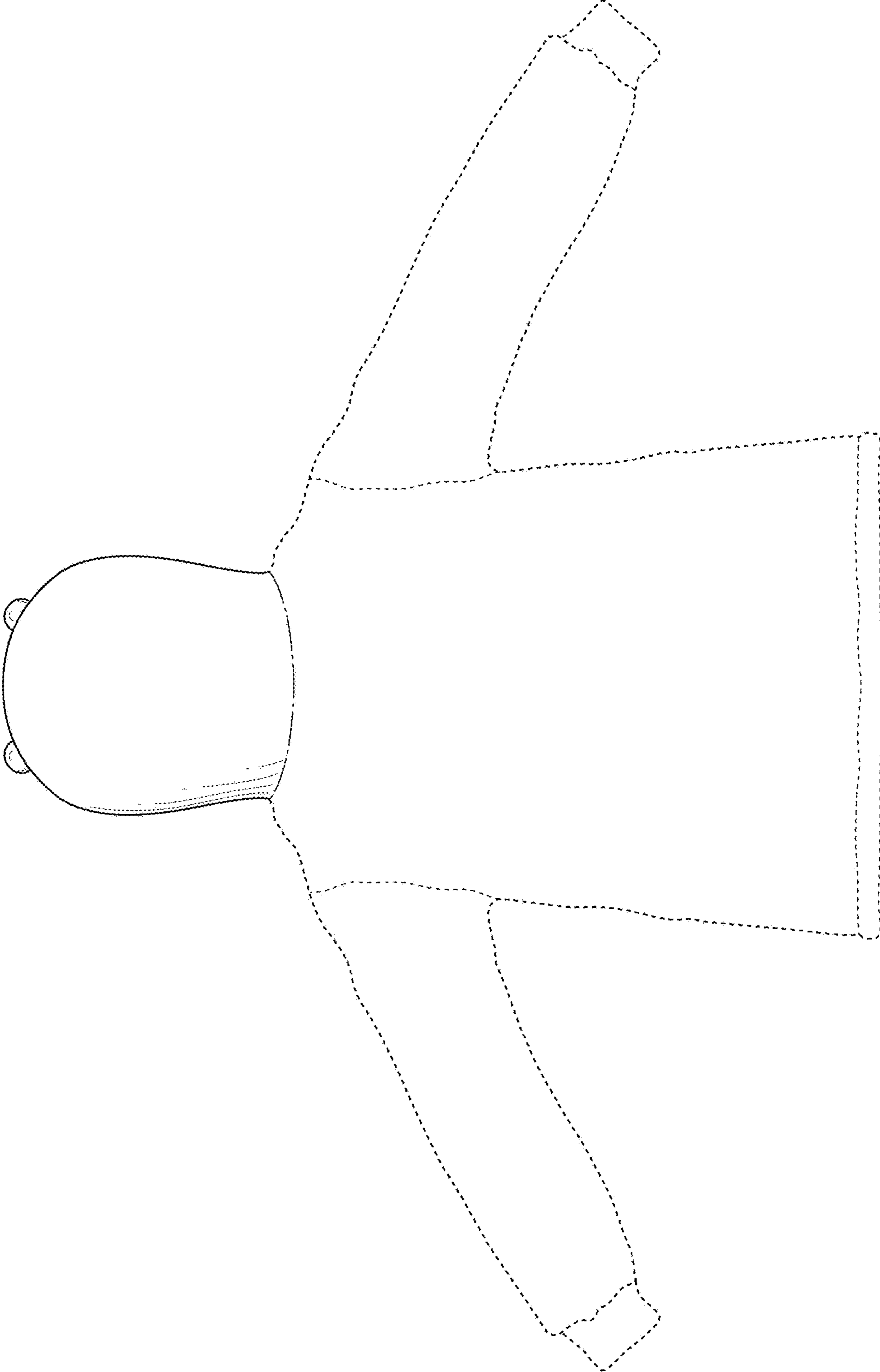

FIG. 3

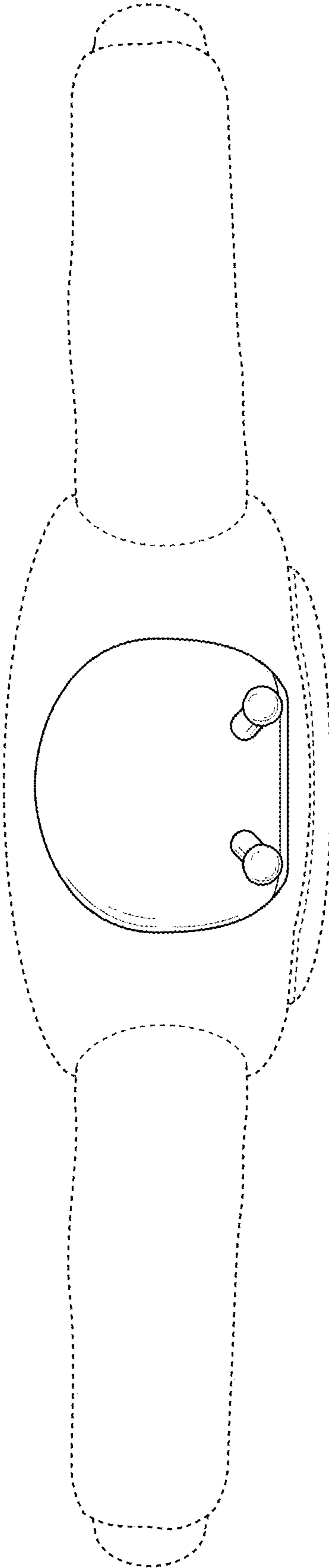

FIG. 4

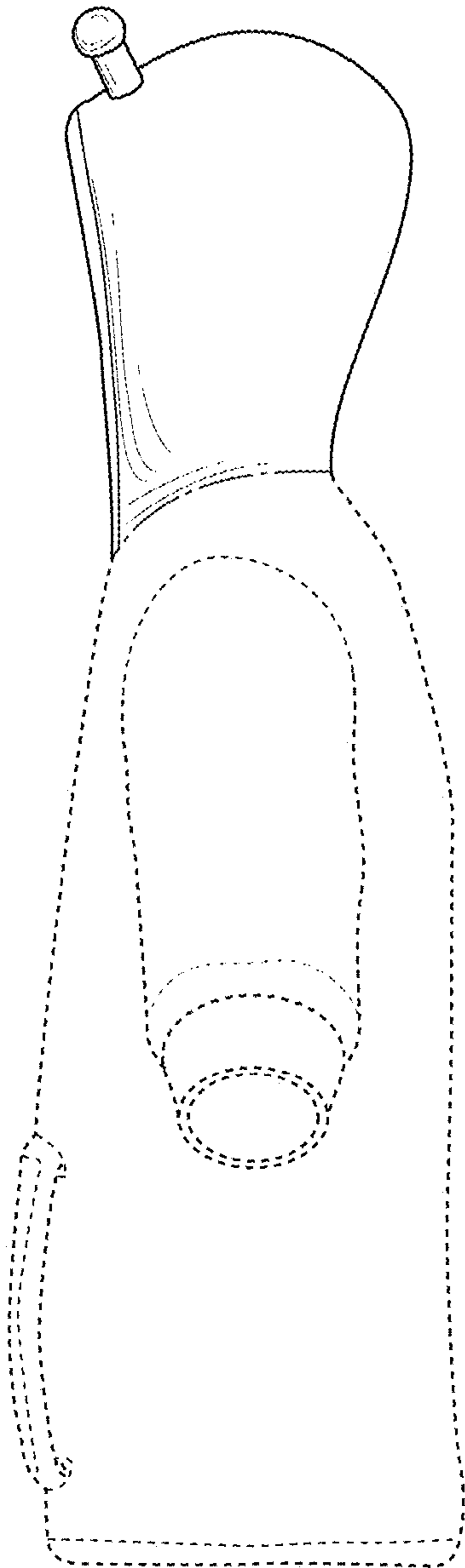

FIG. 5

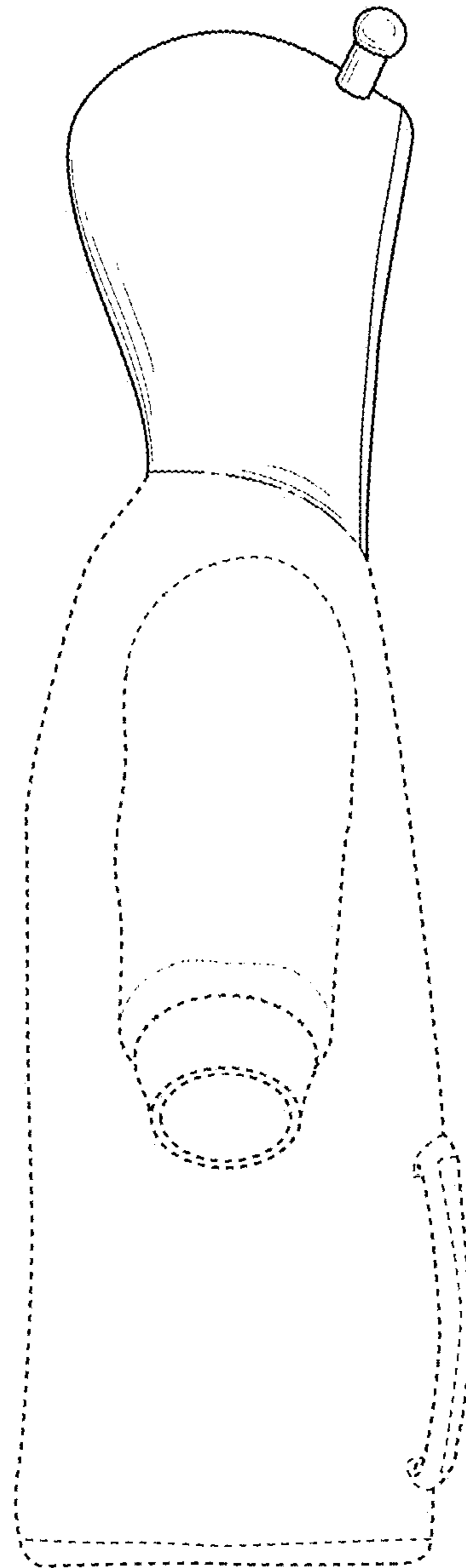

FIG. 6

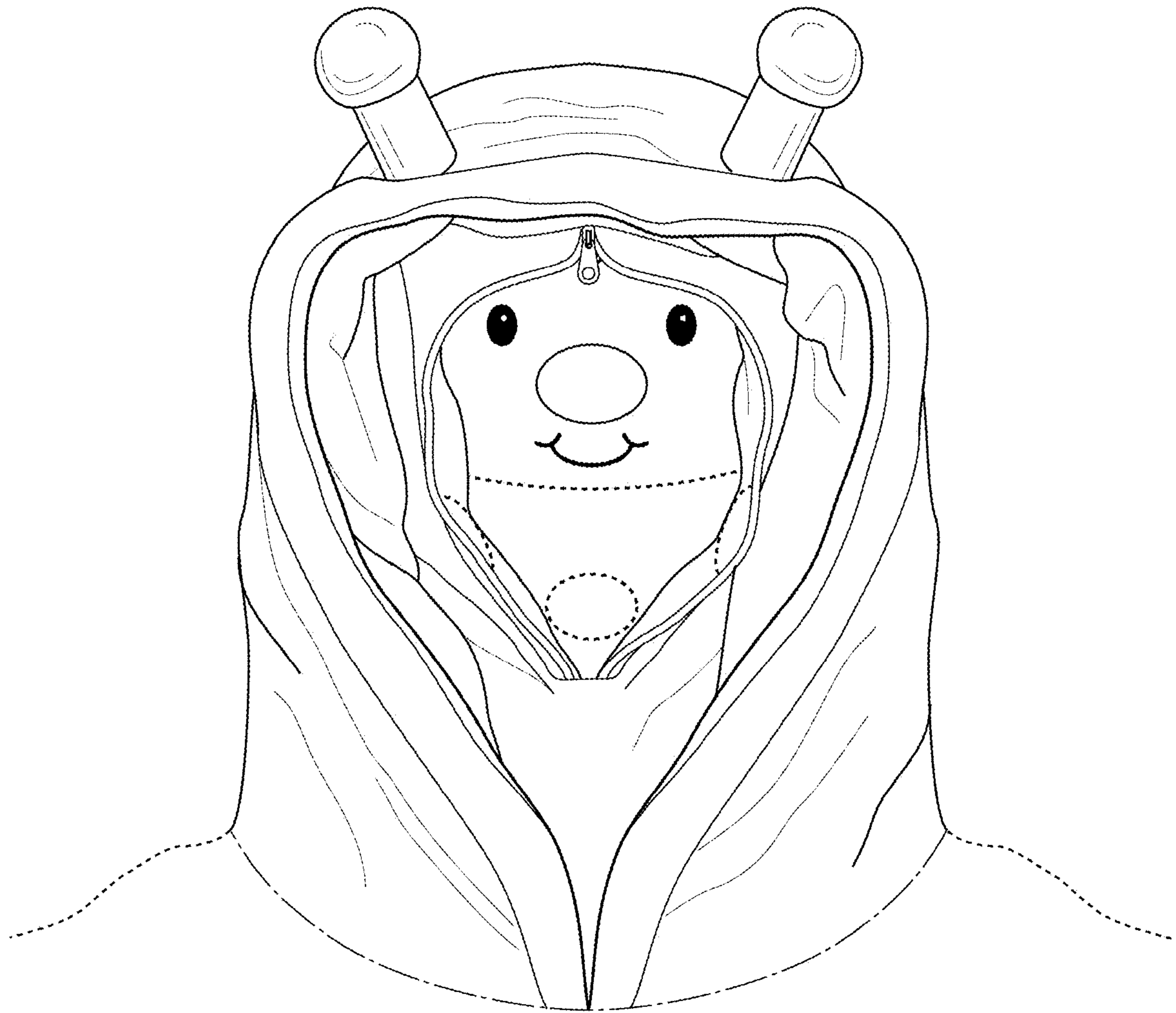

FIG. 7



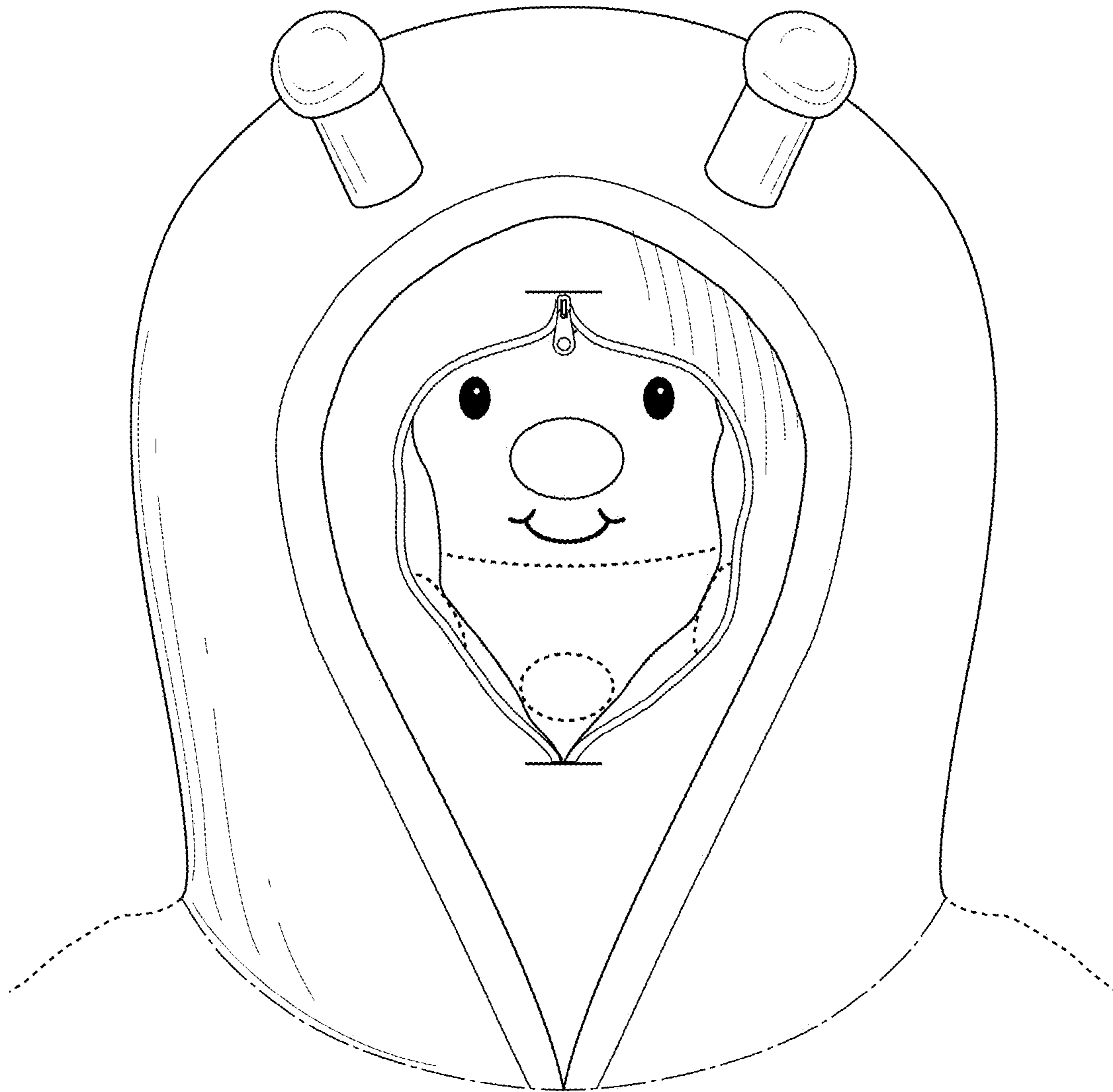

FIG. 8