



US00D881528S

(12) **United States Design Patent**
Buonocore

(10) **Patent No.:** **US D881,528 S**

(45) **Date of Patent:** **** Apr. 21, 2020**

(54) **LION SWEATSHIRT HOOD**

(71) Applicant: **Ontel Products Corporation**, Fairfield, NJ (US)

(72) Inventor: **Carly Buonocore**, Lincoln Park, NJ (US)

(73) Assignee: **ONTEL PRODUCTS CORPORATION**, Fairfield, NJ (US)

(**) Term: **15 Years**

(21) Appl. No.: **29/680,293**

(22) Filed: **Feb. 14, 2019**

(51) **LOC (12) Cl.** **02-02**

(52) **U.S. Cl.**

USPC **D2/831; D2/878**

(58) **Field of Classification Search**

USPC D2/728, 823, 824, 825, 826, 828, 831, D2/865, 866, 867, 870, 874, 877, 878, D2/880, 881, 887, 891, 892, 895; D5/13, D5/14, 20, 63, 64, 65; D6/598; D21/659, 660; D29/102, 108

CPC A41D 3/02; A41D 11/00; A41D 15/005; A41D 15/04; A41D 2200/20; A41D 27/08; A42B 1/00; A42B 1/006; A42B 1/04; A42B 1/041; A42B 1/045; A42B 1/046; A42B 1/048; A42B 7/00; A47G 9/1045; A63H 3/00

See application file for complete search history.

(56) **References Cited**

U.S. PATENT DOCUMENTS

4,543,669 A 10/1985 Katz
D285,815 S * 9/1986 Finn D2/741
D325,296 S * 4/1992 Wu D2/872
D522,788 S * 6/2006 Keller D6/598

D551,429 S * 9/2007 Wager D2/831
D589,682 S * 4/2009 Knab D2/869
D663,105 S * 7/2012 Selivon D2/870
D672,534 S * 12/2012 Smith D2/878
8,864,544 B2 * 10/2014 Anderman A63H 3/003
2/75

(Continued)

Primary Examiner — Jasmine Mlinarcik

(74) *Attorney, Agent, or Firm* — Dickinson Wright PLLC

(57) **CLAIM**

I claim the ornamental design for a lion sweatshirt hood, as shown and described.

DESCRIPTION

FIG. 1 is a front perspective view of a lion sweatshirt hood; FIG. 2 is a front view of the lion sweatshirt hood of FIG. 1; FIG. 3 is a rear view of the lion sweatshirt hood of FIG. 1; FIG. 4 is a top view of the lion sweatshirt hood of FIG. 1; FIG. 5 is a right side view of the lion sweatshirt hood of FIG. 1; FIG. 6 is a left side view of the lion sweatshirt hood of FIG. 1; FIG. 7 is a front view of the lion sweatshirt hood of FIG. 1 in a laid-flat position with a zipper in an open position; and, FIG. 8 is a front view of the lion sweatshirt hood of FIG. 1 with a zipper in an open position.

The zipper follows the curvature of the lion sweatshirt hood. The facial features are an applied motif that follows the curvature of the lion sweatshirt hood.

The dash-dot-dash broken line defines the bounds of the claim and forms no part of the claimed design. The even-length broken lines along the hood portion of the lion sweatshirt hood depict features that form no part of the claimed design. The even-length broken lines beyond the boundary line depicts portions of the lion sweatshirt hood that form no part of the claimed design.

1 Claim, 7 Drawing Sheets

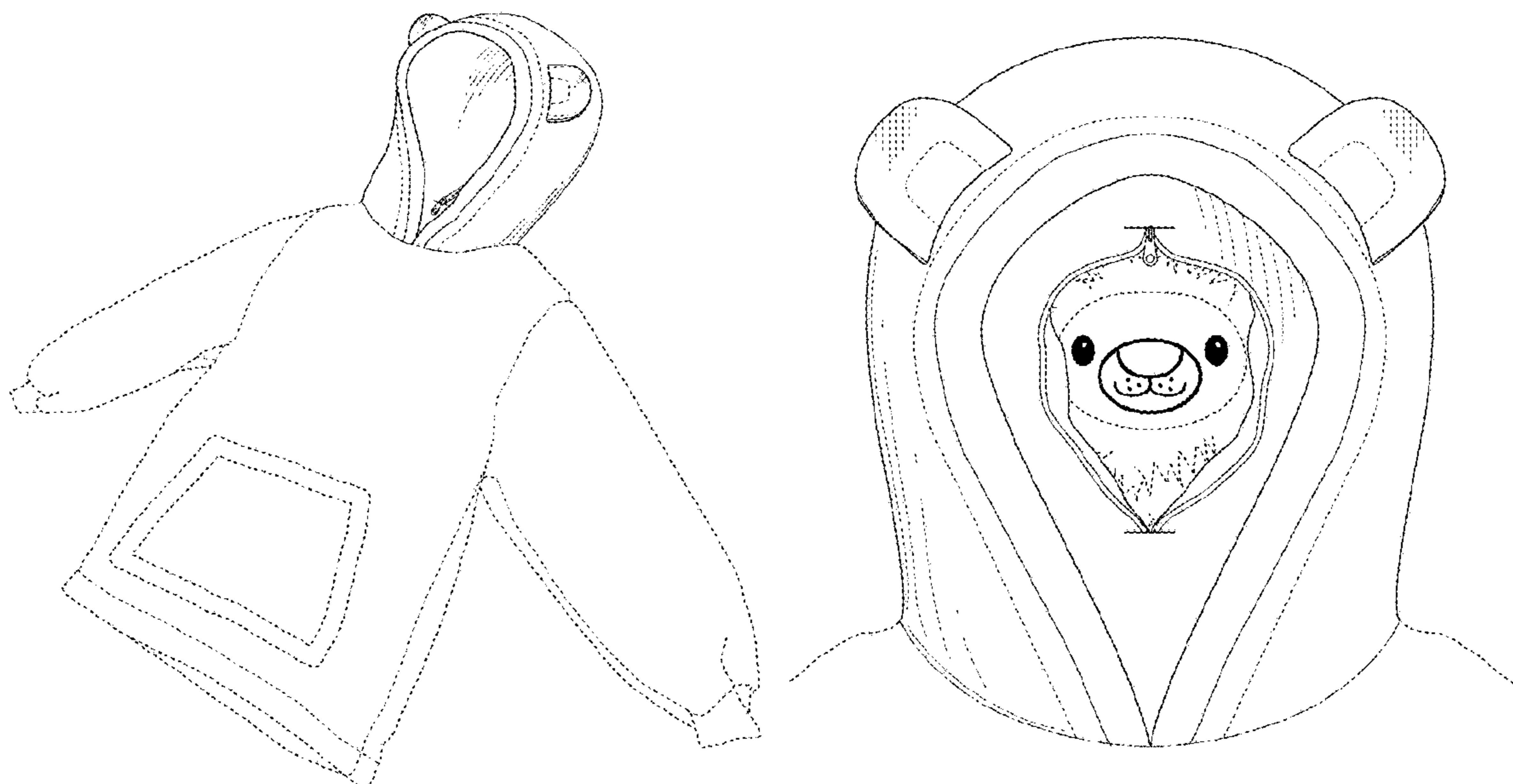

(56)

References Cited

U.S. PATENT DOCUMENTS

9,277,732	B1 *	3/2016	Chrostowski	A01K 13/006
D761,524	S *	7/2016	Cook	D2/878
9,936,746	B1	4/2018	Park	
D836,302	S *	12/2018	Alba	D2/867
2004/0181844	A1 *	9/2004	Kim	A41D 3/02 2/93
2008/0115254	A1	5/2008	Galkov	
2014/0237700	A1	8/2014	Albert	
2015/0121604	A1	5/2015	Lee et al.	
2017/0065109	A1 *	3/2017	Peel	A63H 3/02
2018/0132551	A1	5/2018	Holder, III	

* cited by examiner

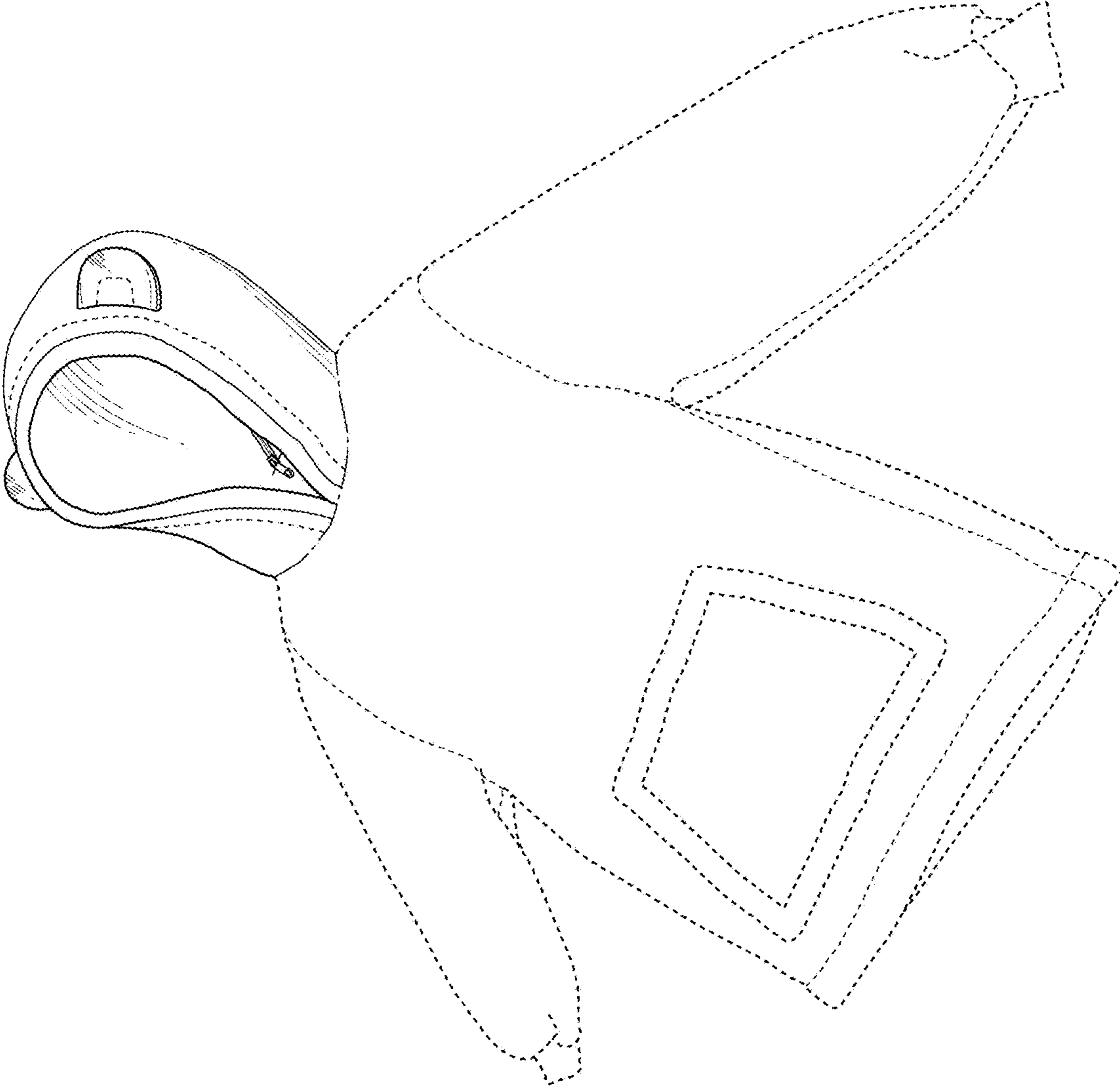

FIG. 1

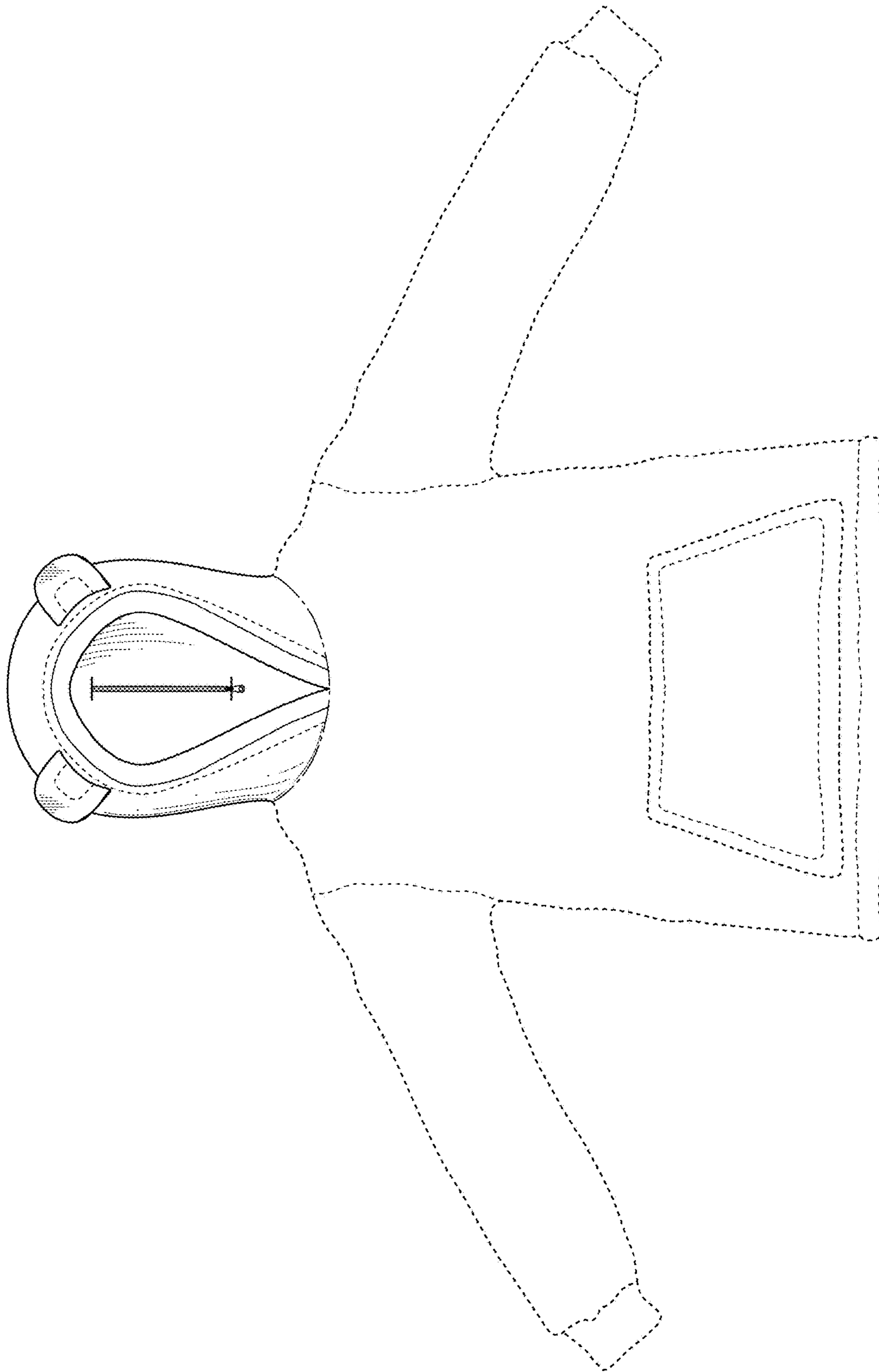

FIG. 2

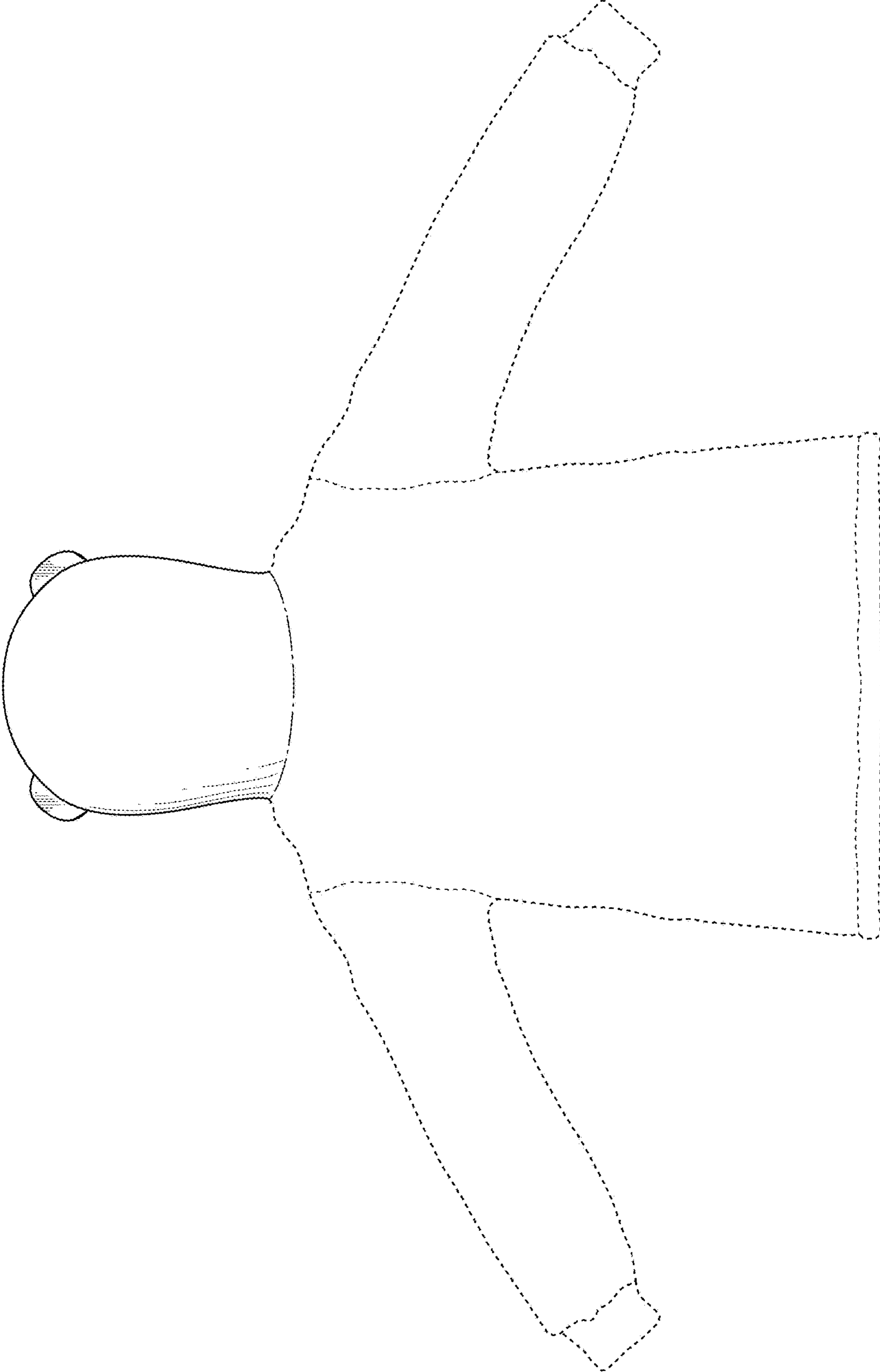

FIG. 3

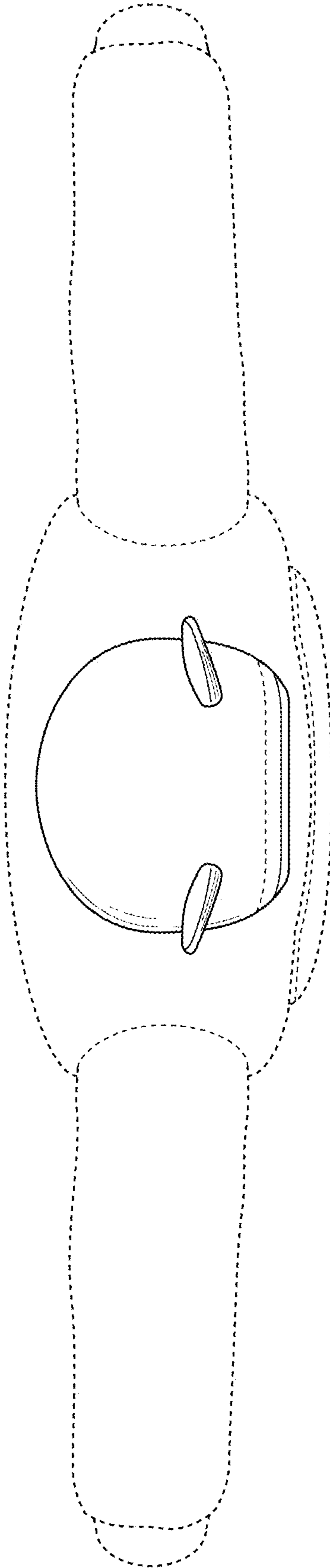

FIG. 4

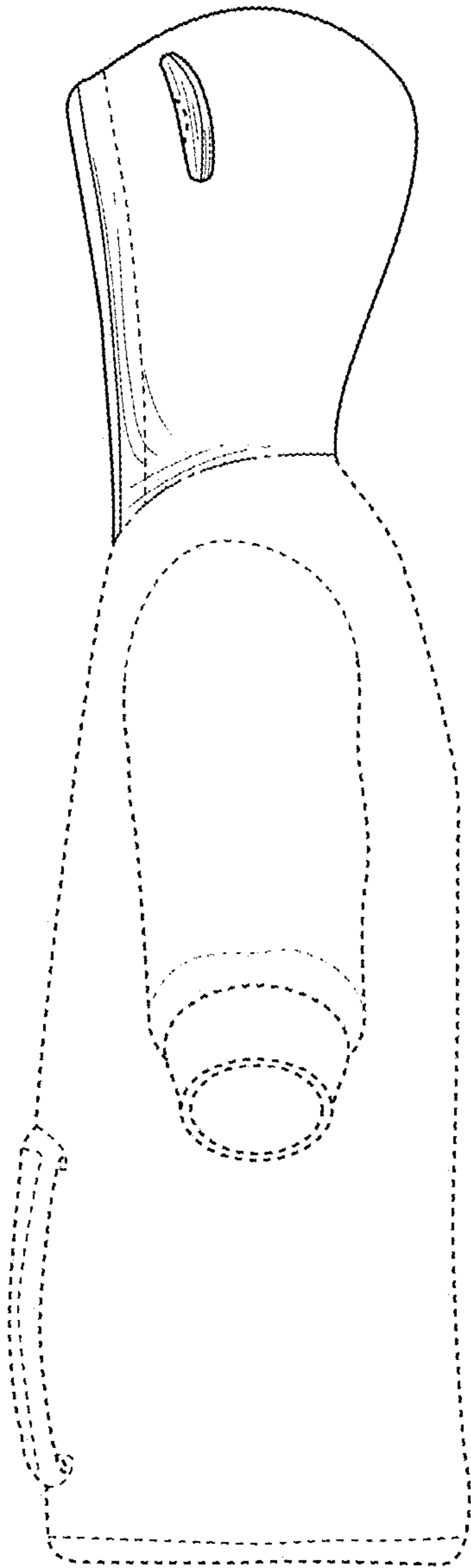

FIG. 5

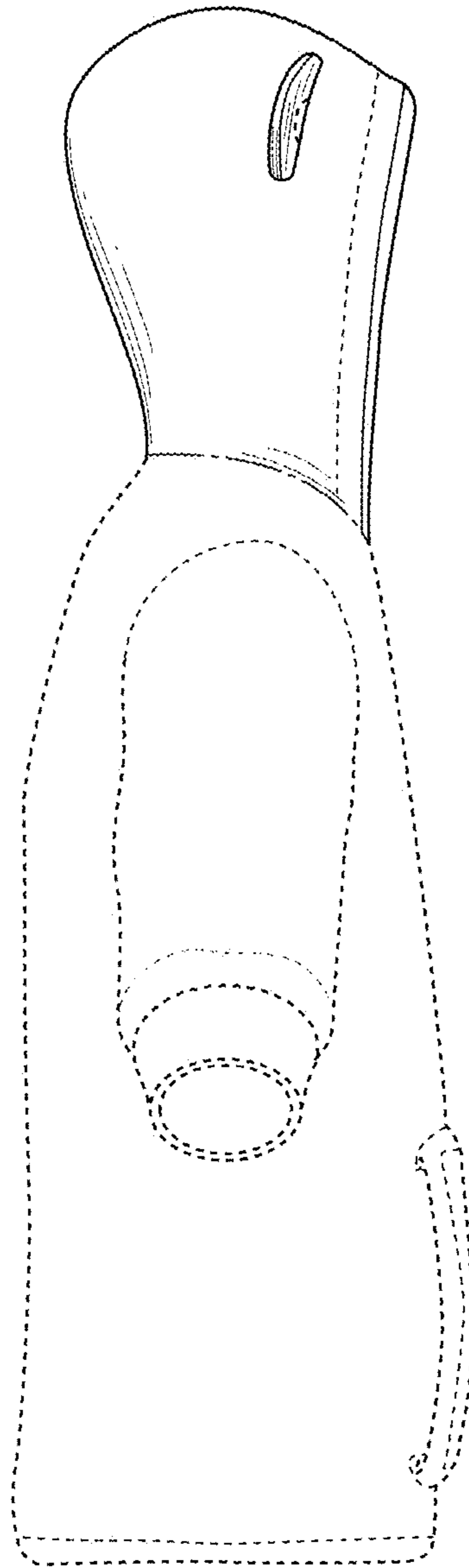

FIG. 6



FIG. 7



FIG. 8