



US00D881526S

(12) **United States Design Patent**  
**Buonocore**

(10) **Patent No.:** **US D881,526 S**

(45) **Date of Patent:** **\*\* Apr. 21, 2020**

(54) **FOX SWEATSHIRT HOOD**

(71) Applicant: **Ontel Products Corporation**, Fairfield, NJ (US)

(72) Inventor: **Carly Buonocore**, Lincoln Park, NJ (US)

(73) Assignee: **ONTEL PRODUCTS CORPORATION**, Fairfield, NJ (US)

(\*\*) Term: **15 Years**

(21) Appl. No.: **29/680,273**

(22) Filed: **Feb. 14, 2019**

(51) **LOC (12) Cl.** ..... **02-02**

(52) **U.S. Cl.**

USPC ..... **D2/831; D2/878**

(58) **Field of Classification Search**

USPC ..... D2/728, 823, 824, 825, 826, 828, 831, D2/865, 866, 867, 870, 874, 877, 878, D2/880, 881, 887, 891, 892, 895; D5/13, D5/14, 20, 63, 64, 65; D6/598; D21/659, 660; D29/102, 108

CPC ..... A41D 3/02; A41D 11/00; A41D 15/005; A41D 15/04; A41D 2200/20; A41D 27/08; A42B 1/00; A42B 1/006; A42B 1/04; A42B 1/041; A42B 1/045; A42B 1/046; A42B

(Continued)

(56) **References Cited**

**U.S. PATENT DOCUMENTS**

4,451,933 A \* 6/1984 Seng ..... A41G 7/00  
2/173

4,543,669 A 10/1985 Katz

D324,943 S \* 3/1992 Wu ..... D2/872

(Continued)

**OTHER PUBLICATIONS**

Black Stripe Orange Fox Ears Hoodie, [on-line]; [review posted to the Internet on Oct. 5, 2017]; [retrieved from the Internet on Apr. 1, 2019]; URL: <https://www.uponabowtique.com/products/black-stripe-orange-fox-ears-hoodie>. (2 pgs). (Year: 2017).\*

(Continued)

*Primary Examiner* — Jasmine Mlinarcik

(74) *Attorney, Agent, or Firm* — Dickinson Wright PLLC

(57) **CLAIM**

I claim the ornamental design for a fox sweatshirt hood, as shown and described.

**DESCRIPTION**

FIG. 1 is a front perspective view of a fox sweatshirt hood; FIG. 2 is a front view of the fox sweatshirt hood of FIG. 1; FIG. 3 is a rear view of the fox sweatshirt hood of FIG. 1; FIG. 4 is a top view of the fox sweatshirt hood of FIG. 1; FIG. 5 is a right side view of the fox sweatshirt hood of FIG. 1;

FIG. 6 is a left side view of the fox sweatshirt hood of FIG. 1;

FIG. 7 is a front view of the fox sweatshirt hood of FIG. 1 in a laid-flat position with a zipper in an open position; and, FIG. 8 is a front view of the fox sweatshirt hood of FIG. 1 with a zipper in an open position.

The zipper follows the curvature of the fox sweatshirt hood. The facial features are an applied motif that follows the curvature of the fox sweatshirt hood.

The dash-dot-dash broken line defines the bounds of the claim and forms no part of the claimed design. The even-length broken lines along the hood portion of the fox sweatshirt hood depict features that form no part of the claimed design. The even-length broken lines beyond the boundary line depicts portions of the fox sweatshirt hood that form no part of the claimed design.

**1 Claim, 7 Drawing Sheets**

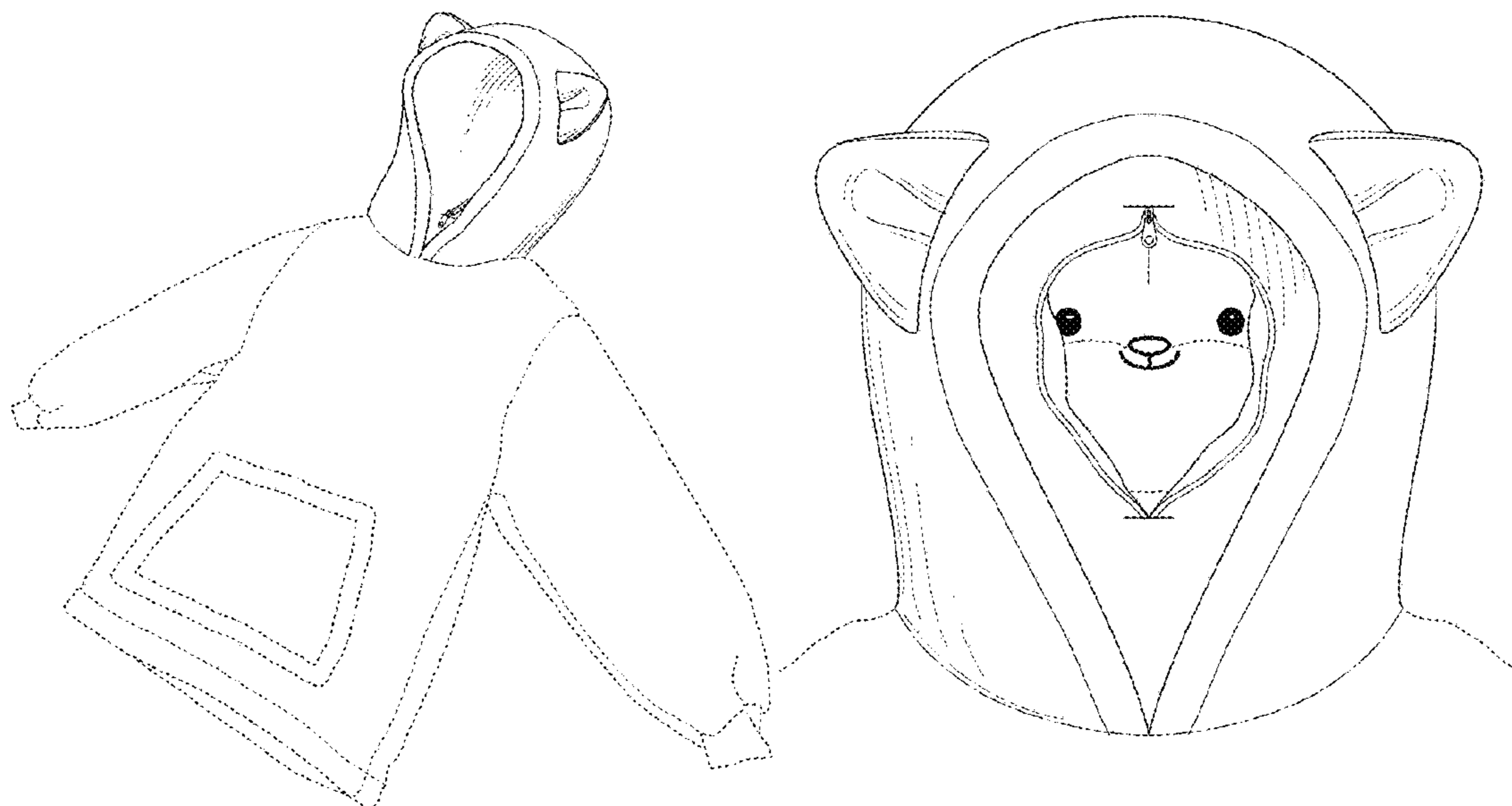

(58) **Field of Classification Search**

CPC ..... 1/048; A42B 7/00; A47G 9/1045; A63H  
3/00

See application file for complete search history.

(56) **References Cited**

U.S. PATENT DOCUMENTS

D420,178 S \* 2/2000 Bionde ..... D21/659  
6,651,256 B1 \* 11/2003 Swift ..... A42B 1/004  
2/15  
D551,429 S \* 9/2007 Wager ..... D2/831  
D589,683 S \* 4/2009 Knab ..... D2/869  
D672,534 S \* 12/2012 Smith ..... D2/878  
D695,965 S \* 12/2013 Ratner ..... D29/102  
D708,822 S \* 7/2014 Douglas ..... D2/880  
8,864,544 B2 \* 10/2014 Anderman ..... A63H 3/003  
2/75  
D761,524 S \* 7/2016 Cook ..... D2/878  
9,573,073 B1 \* 2/2017 Mazur ..... A63H 33/004  
9,936,746 B1 4/2018 Park  
D836,302 S \* 12/2018 Alba ..... D2/867  
2008/0115254 A1 5/2008 Galkov  
2014/0237700 A1 8/2014 Albert  
2015/0121604 A1 5/2015 Lee et al.  
2018/0132551 A1 5/2018 Holder, III

OTHER PUBLICATIONS

Flynn the Fox, [on-line]; [review posted to the Internet on Nov. 4, 2018]; [retrieved from the Internet on Apr. 1, 2019]; URL: <https://cubcoats.com/collections/signature-series/products/flynn-the-fox>. (2 pgs). (Year: 2018).\*  
Cubcoats website; <https://cubcoats.com/collections/cubcoats>; 4 pages; accessed Jan. 24, 2019.

\* cited by examiner

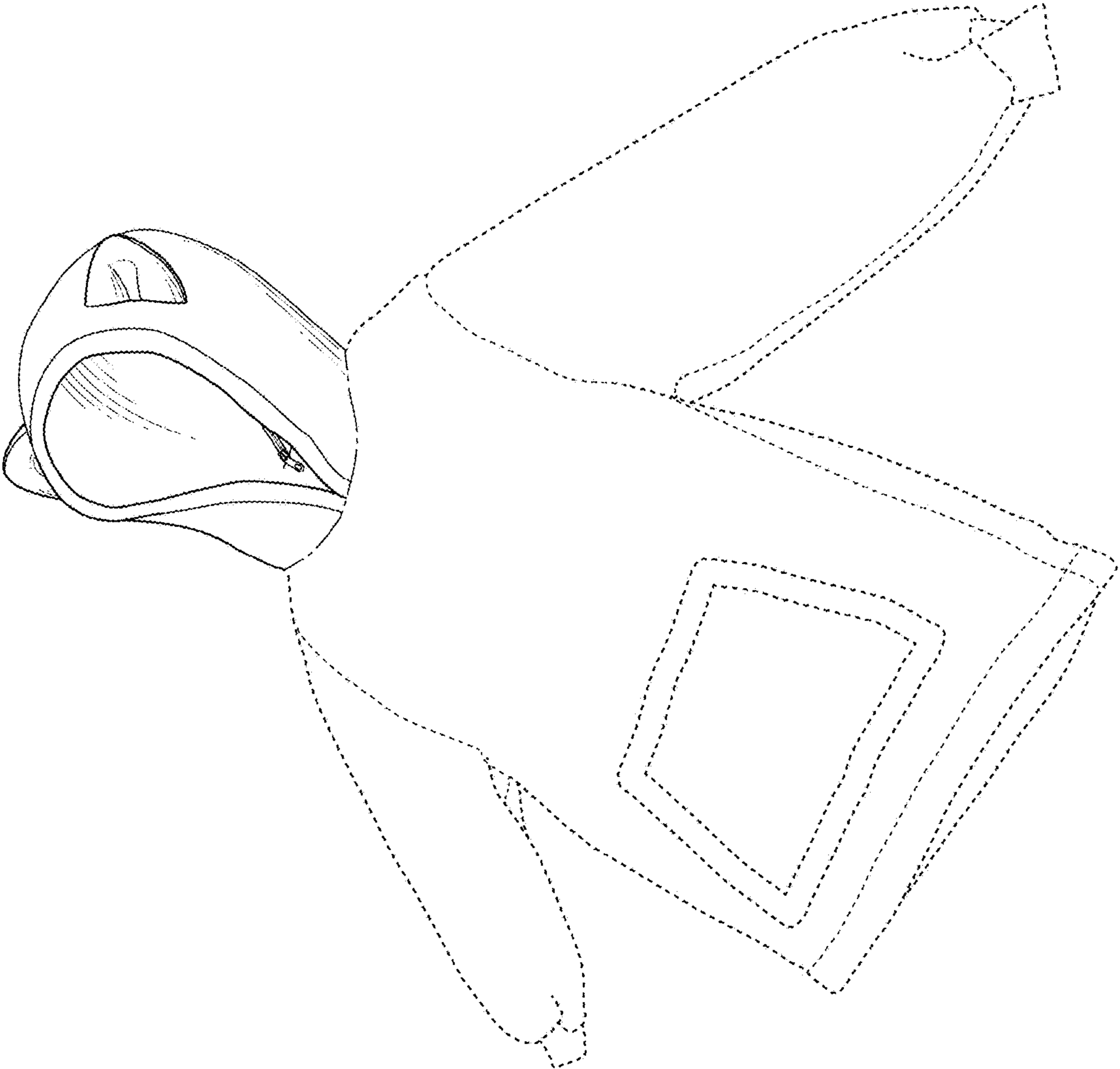

FIG. 1

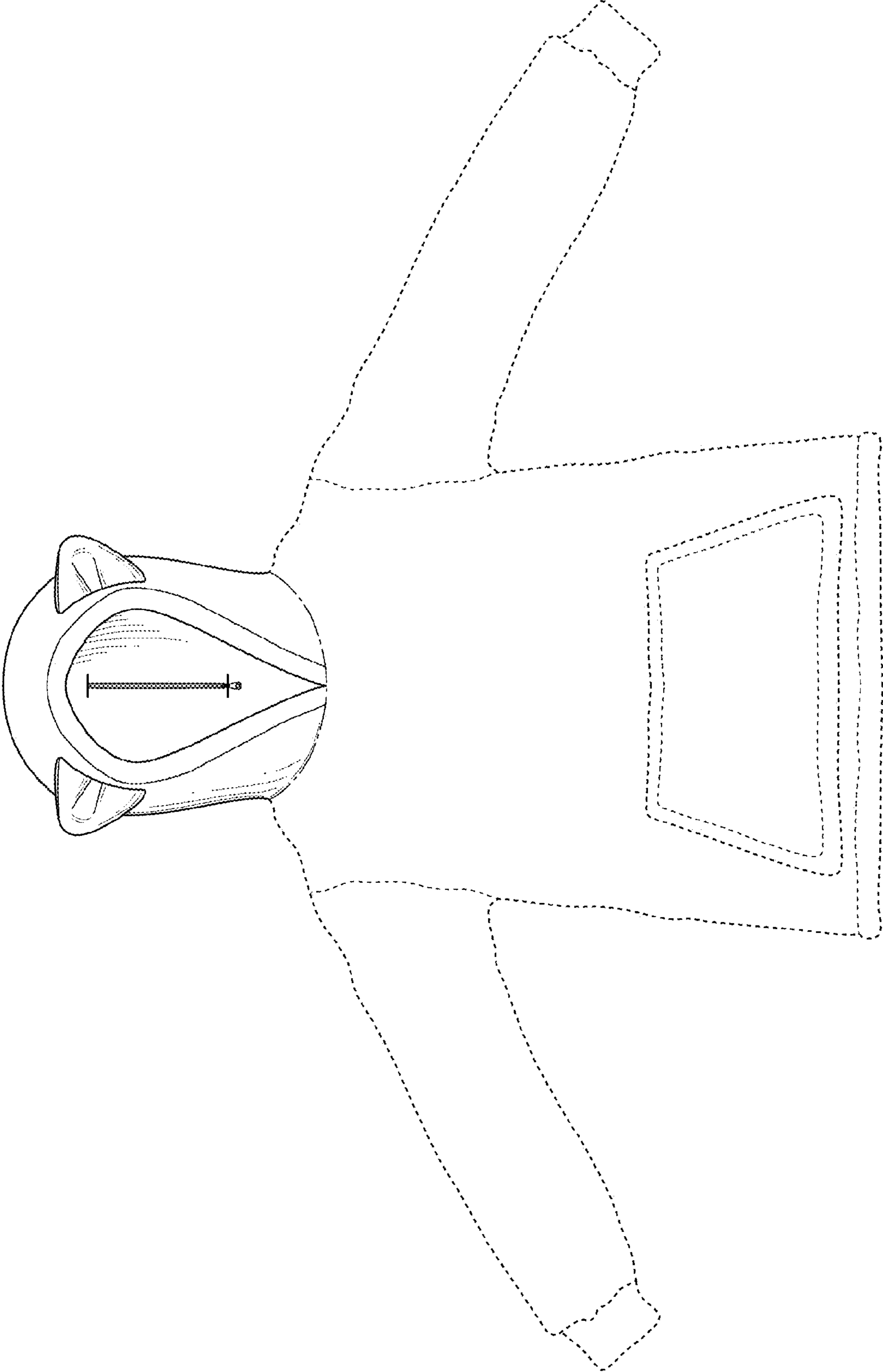

FIG. 2

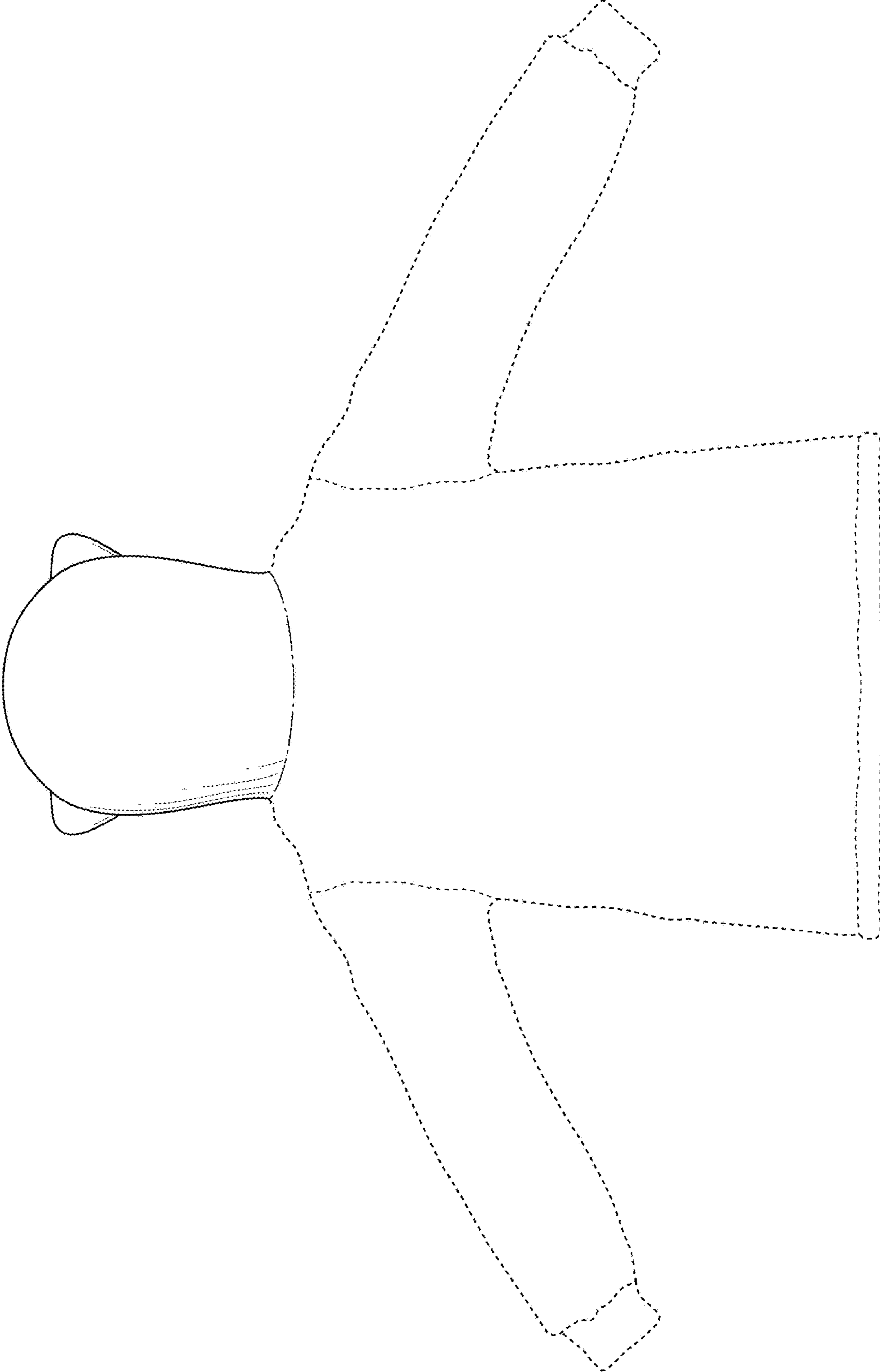

FIG. 3

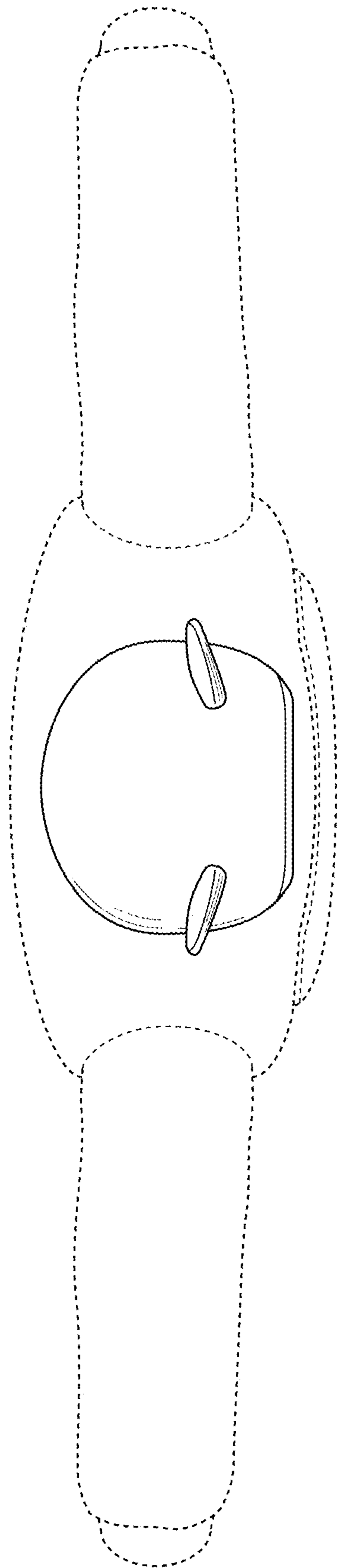

FIG. 4



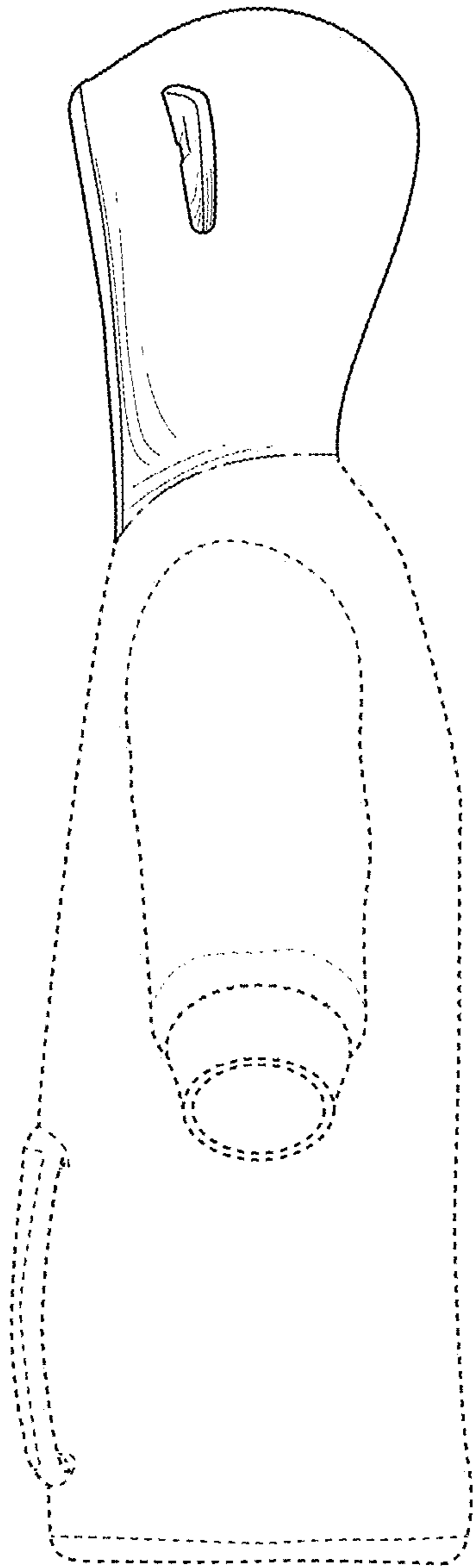

FIG. 5

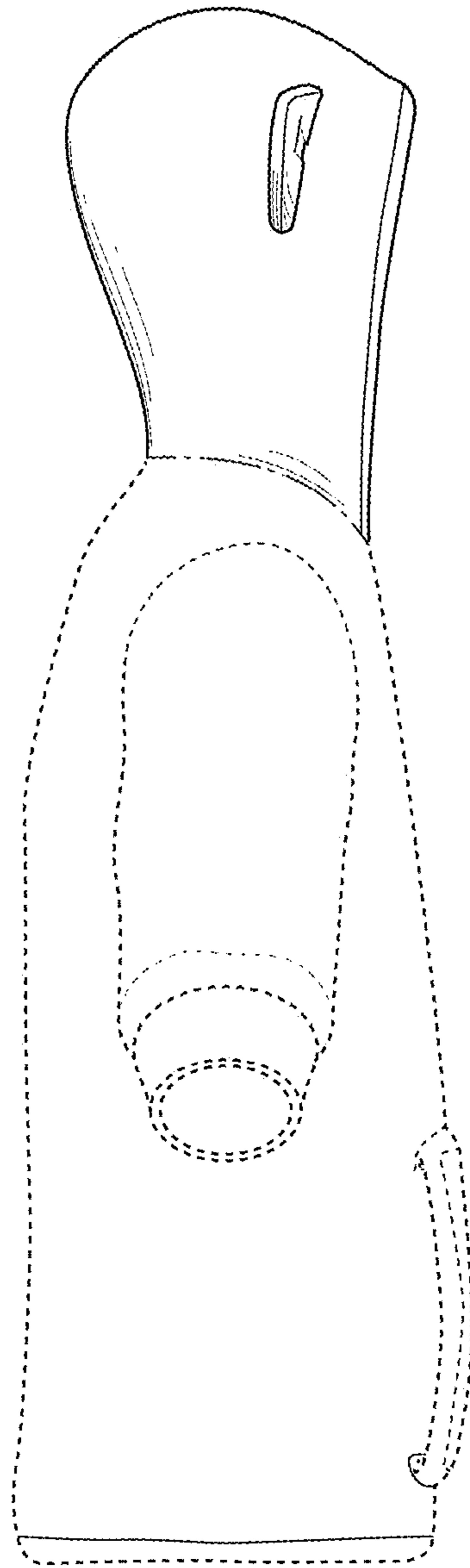

FIG. 6

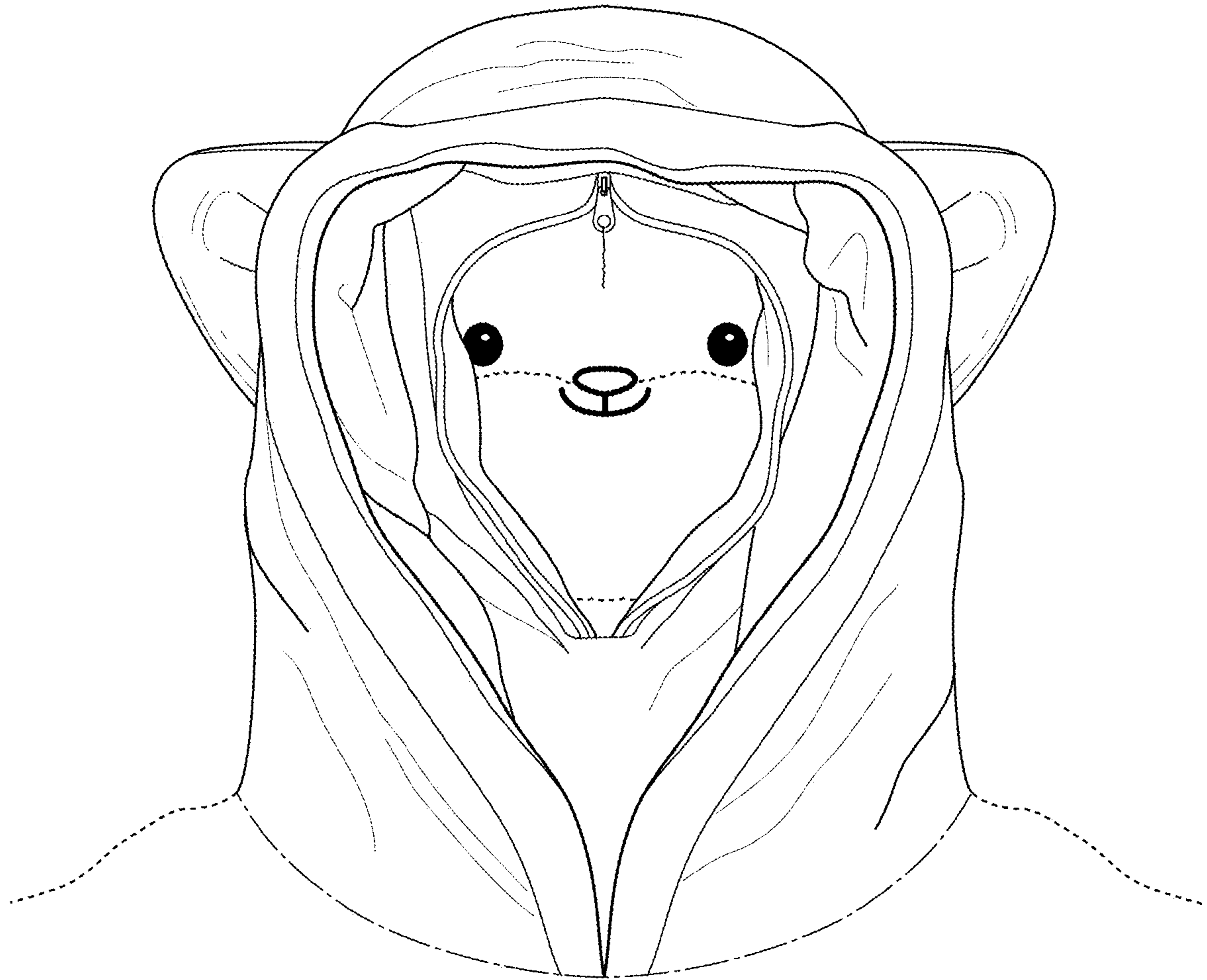

FIG. 7



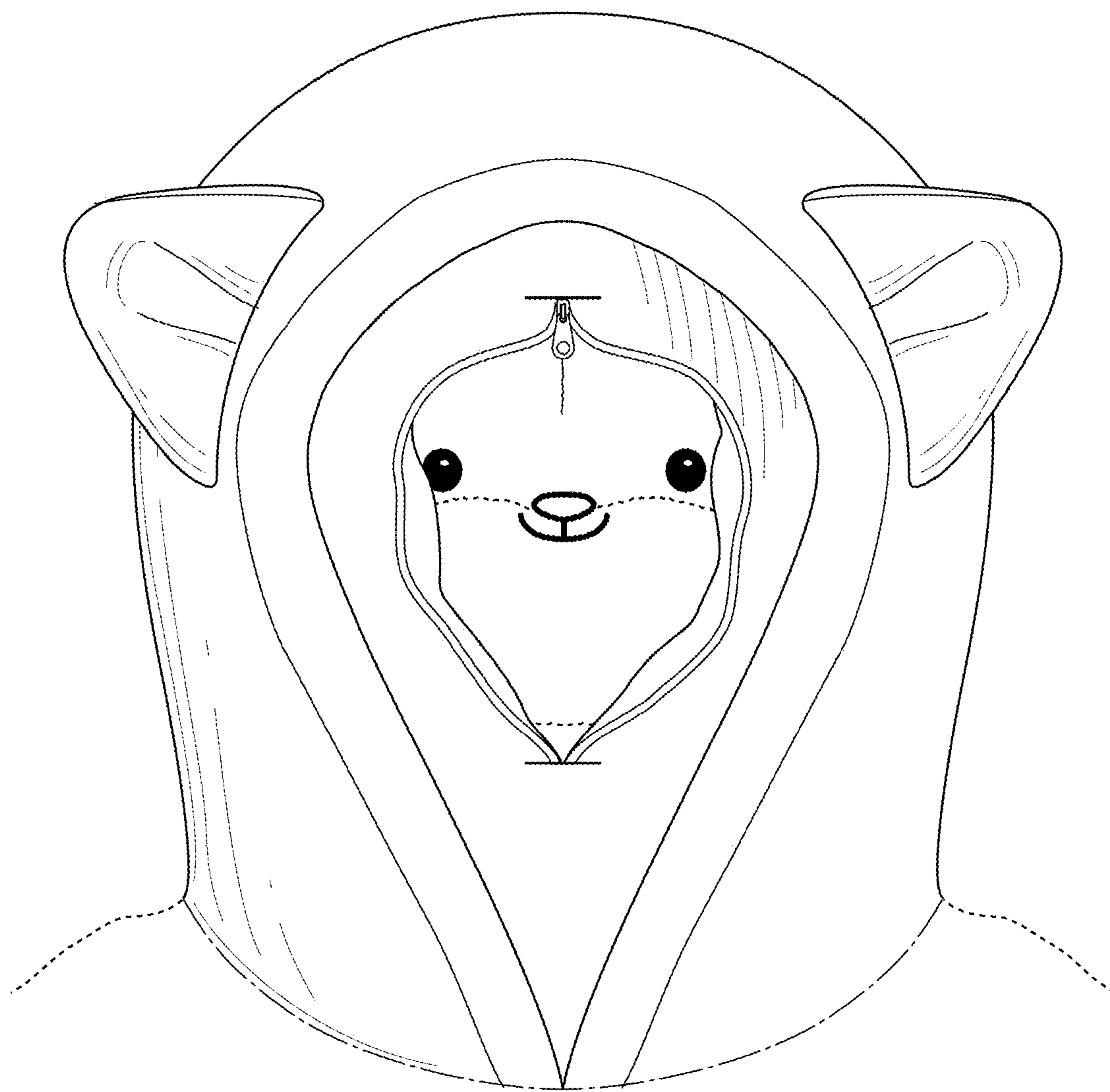

FIG. 8