



US00D881524S

(12) **United States Design Patent**
Buonocore

(10) **Patent No.:** **US D881,524 S**

(45) **Date of Patent:** **** Apr. 21, 2020**

(54) **PENGUIN SWEATSHIRT HOOD**

(71) Applicant: **Ontel Products Corporation**, Fairfield, NJ (US)

(72) Inventor: **Carly Buonocore**, Lincoln Park, NJ (US)

(73) Assignee: **ONTEL PRODUCTS CORPORATION**, Fairfield, NJ (US)

(**) Term: **15 Years**

(21) Appl. No.: **29/680,266**

(22) Filed: **Feb. 14, 2019**

(51) **LOC (12) Cl.** **02-02**

(52) **U.S. Cl.**

USPC **D2/831; D2/878**

(58) **Field of Classification Search**

USPC D2/728, 823, 824, 825, 826, 828, 831, D2/865, 866, 867, 870, 874, 877, 878, D2/880, 881, 887, 891, 892, 895; D5/13, D5/14, 20, 63, 64, 65; D6/598; D21/659, 660; D29/102, 108

CPC A41D 3/02; A41D 11/00; A41D 15/005; A41D 15/04; A41D 2200/20; A41D 27/08; A42B 1/00; A42B 1/006; A42B 1/04; A42B 1/041; A42B 1/045; A42B 1/046; A42B 1/048; A42B 7/00; A47G 9/1045; A63H 3/00

See application file for complete search history.

(56) **References Cited**

U.S. PATENT DOCUMENTS

4,451,933 A * 6/1984 Seng A41G 7/00
2/173
4,543,669 A 10/1985 Katz
D529,105 S * 9/2006 Saruhashi D21/578
7,302,710 B2 * 12/2007 Thomas A41D 1/04
2/84

D588,784 S * 3/2009 Cho D2/872
D589,685 S * 4/2009 Knab D2/869
D672,534 S * 12/2012 Smith D2/878

(Continued)

Primary Examiner — Jasmine Mlinarcik

(74) *Attorney, Agent, or Firm* — Dickinson Wright PLLC

(57) **CLAIM**

I claim the ornamental design for a penguin sweatshirt hood, as shown and described.

DESCRIPTION

FIG. 1 is a front perspective view of a penguin sweatshirt hood;

FIG. 2 is a front view of the penguin sweatshirt hood of FIG. 1;

FIG. 3 is a rear view of the penguin sweatshirt hood of FIG. 1;

FIG. 4 is a top view of the penguin sweatshirt hood of FIG. 1;

FIG. 5 is a right side view of the penguin sweatshirt hood of FIG. 1;

FIG. 6 is a left side view of the penguin sweatshirt hood of FIG. 1;

FIG. 7 is a front view of the penguin sweatshirt hood of FIG. 1 in a laid-flat position with a zipper in an open position; and,

FIG. 8 is a front view of the penguin sweatshirt hood of FIG. 1 with a zipper in an open position.

The zipper follows the curvature of the penguin sweatshirt hood. The facial features are an applied motif that follows the curvature of the penguin sweatshirt hood.

The dash-dot-dash broken line defines the bounds of the claim and forms no part of the claimed design. The even-length broken lines along the hood portion of the penguin sweatshirt hood depict features that form no part of the claimed design. The even-length broken lines beyond the boundary line depicts portions of the penguin sweatshirt hood that form no part of the claimed design.

1 Claim, 7 Drawing Sheets

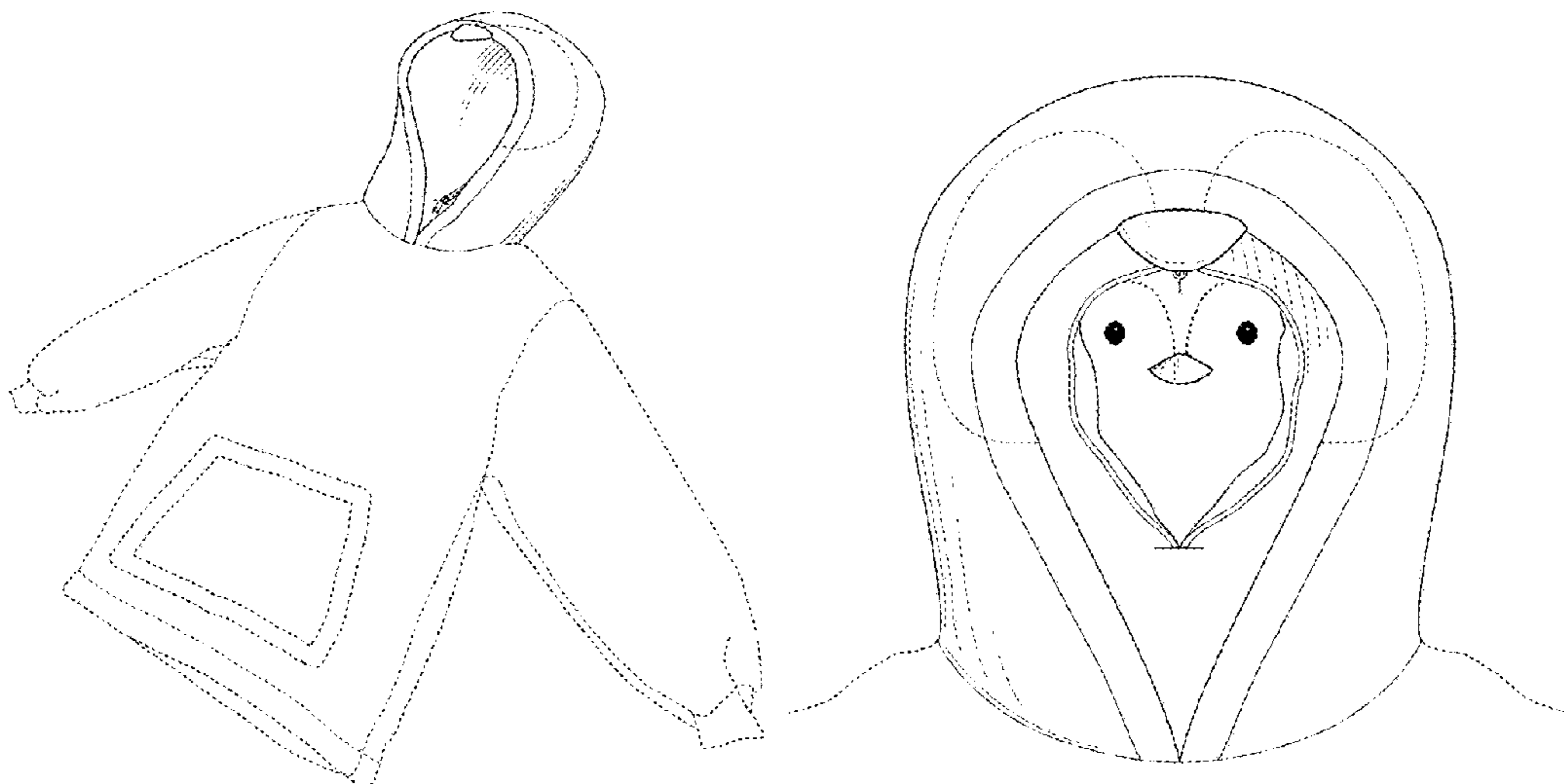

(56)

References Cited

U.S. PATENT DOCUMENTS

8,510,865 B2 * 8/2013 Pyfer A41D 15/00
2/202
D703,771 S * 4/2014 Carlson D21/653
D713,126 S * 9/2014 Franz D2/825
D761,524 S * 7/2016 Cook D2/878
9,936,746 B1 4/2018 Park
2004/0181844 A1 * 9/2004 Kim A41D 3/02
2/93
2008/0115254 A1 5/2008 Galkov
2014/0237700 A1 8/2014 Albert
2015/0121604 A1 5/2015 Lee et al.
2017/0020215 A1 * 1/2017 Merritt A41D 27/201
2018/0132551 A1 5/2018 Holder, III

* cited by examiner

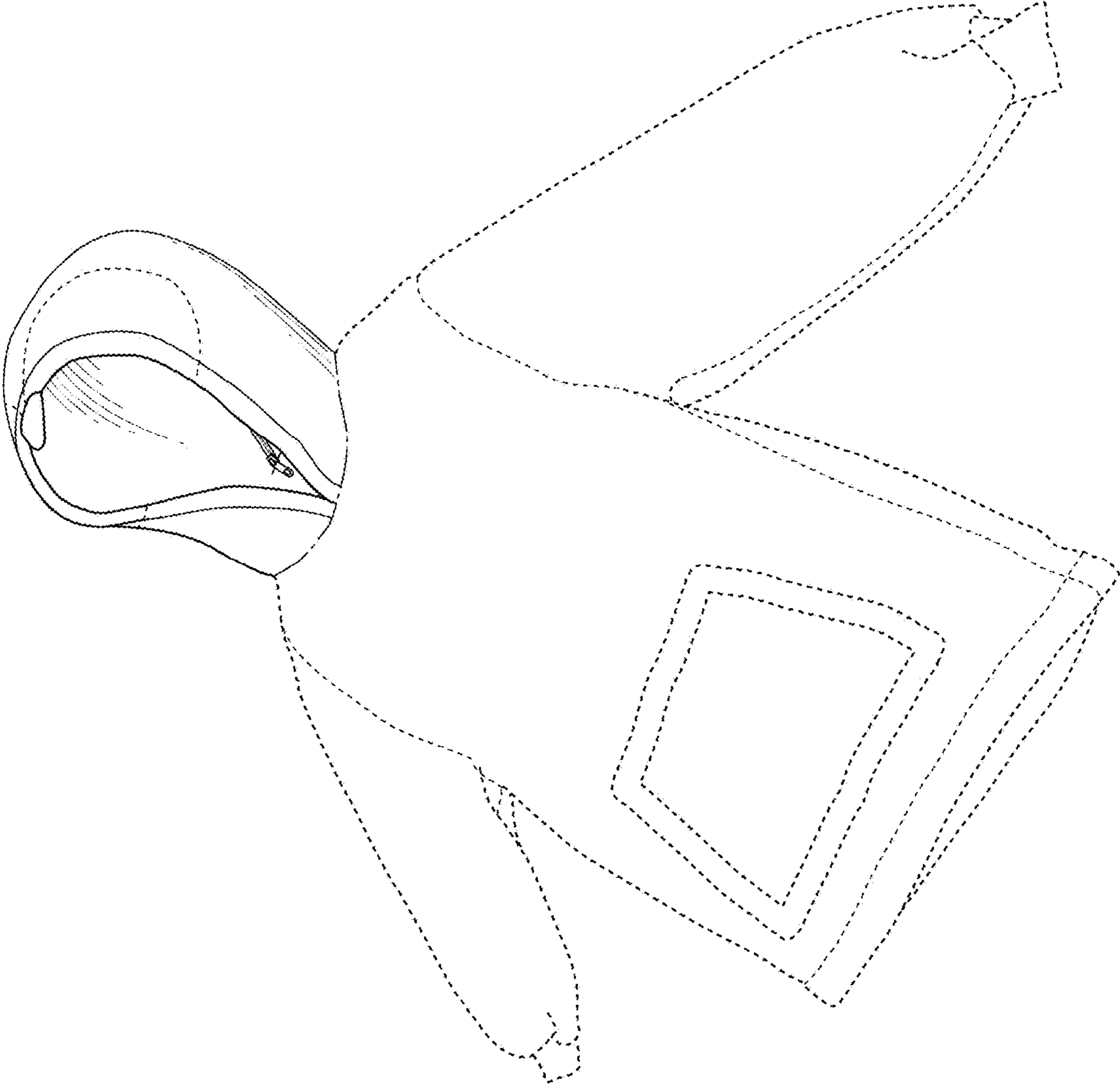

FIG. 1

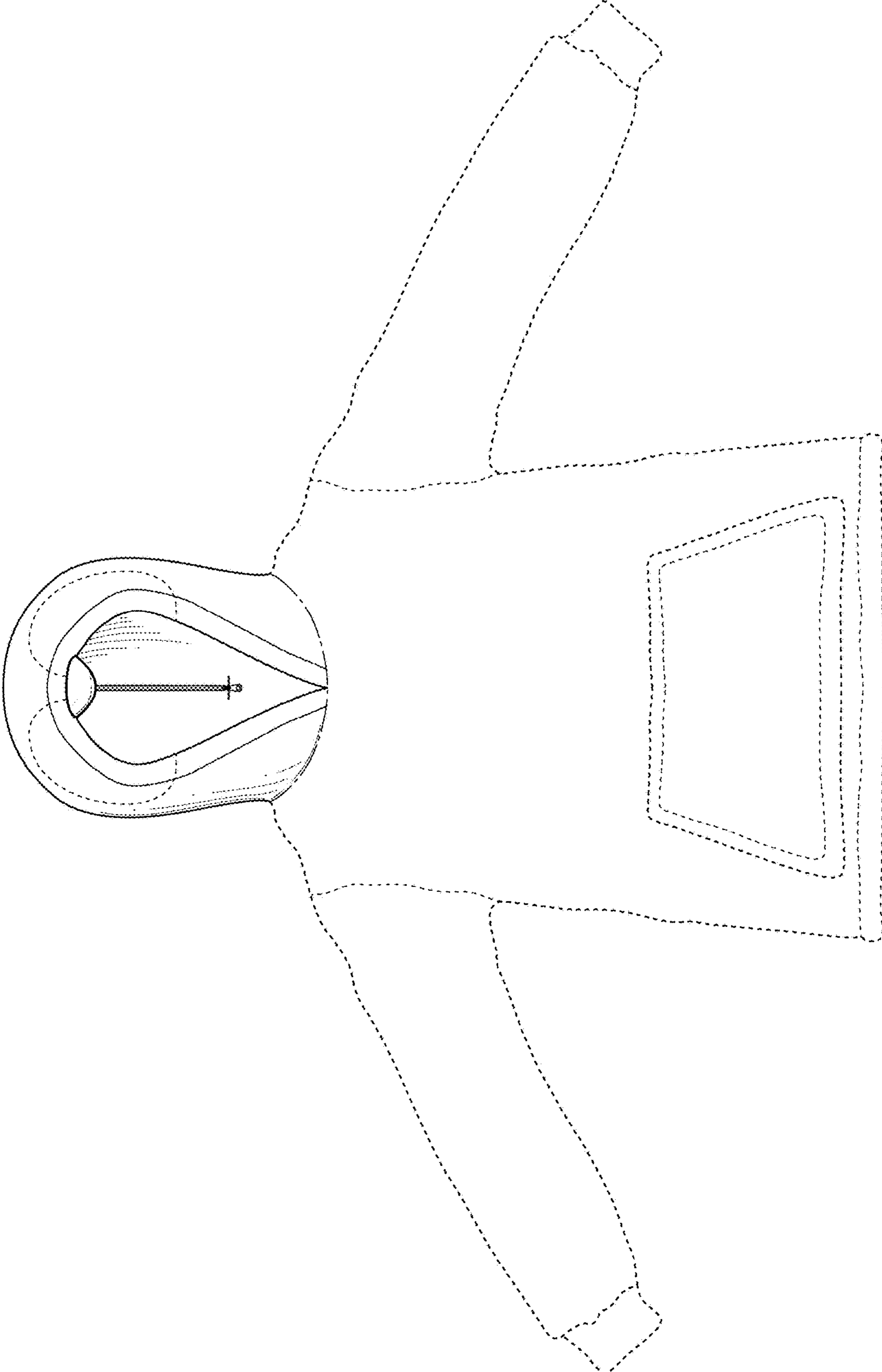

FIG. 2

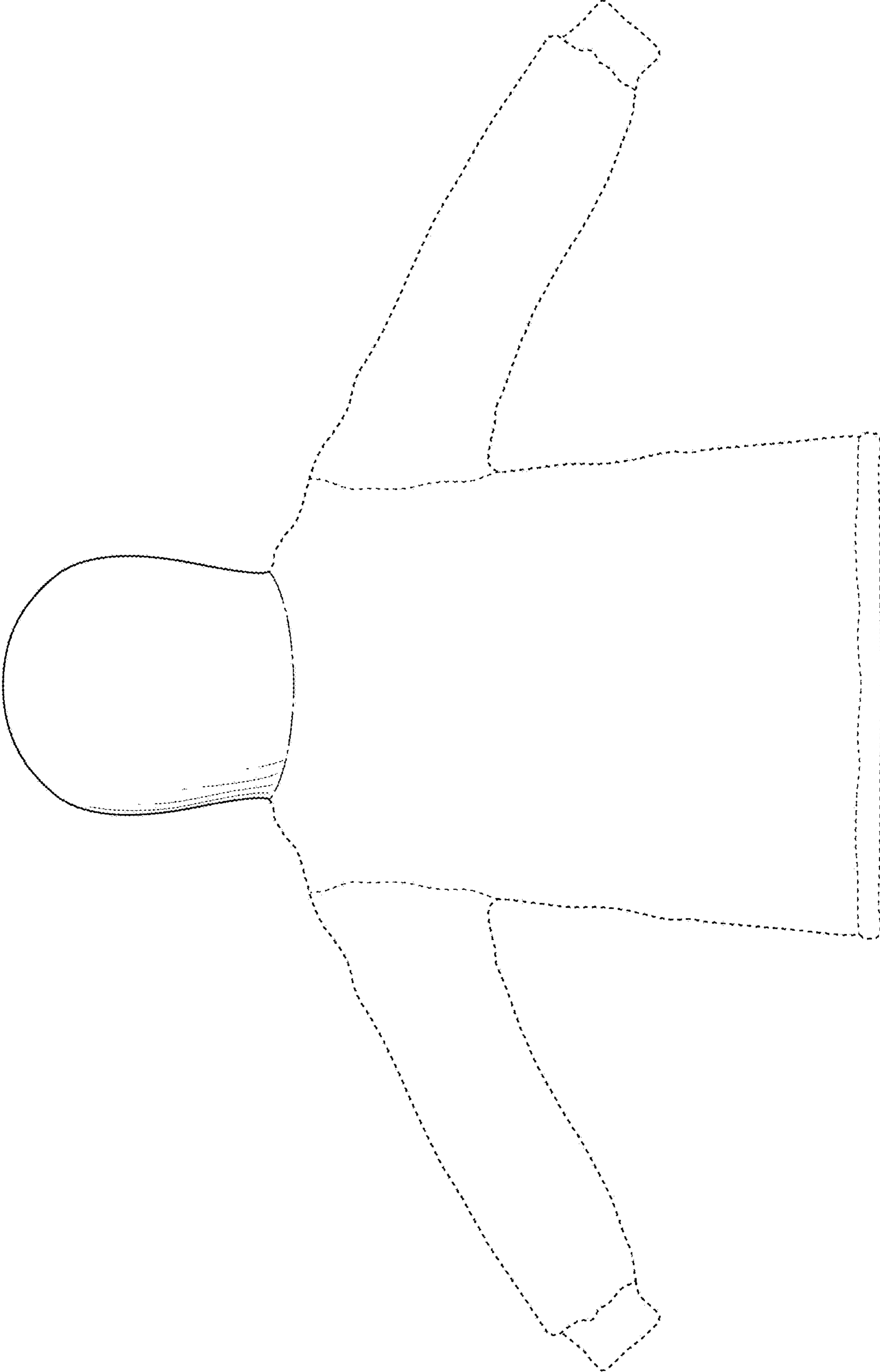

FIG. 3

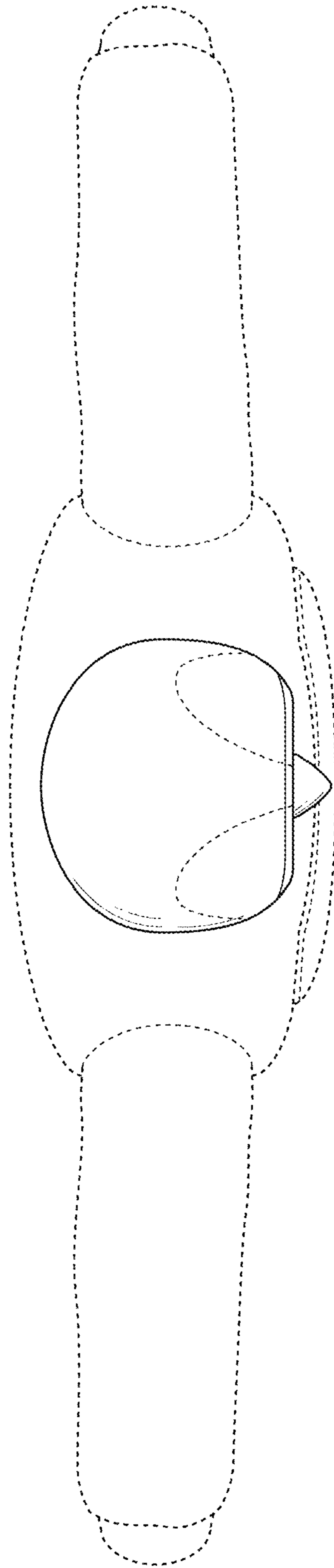

FIG. 4

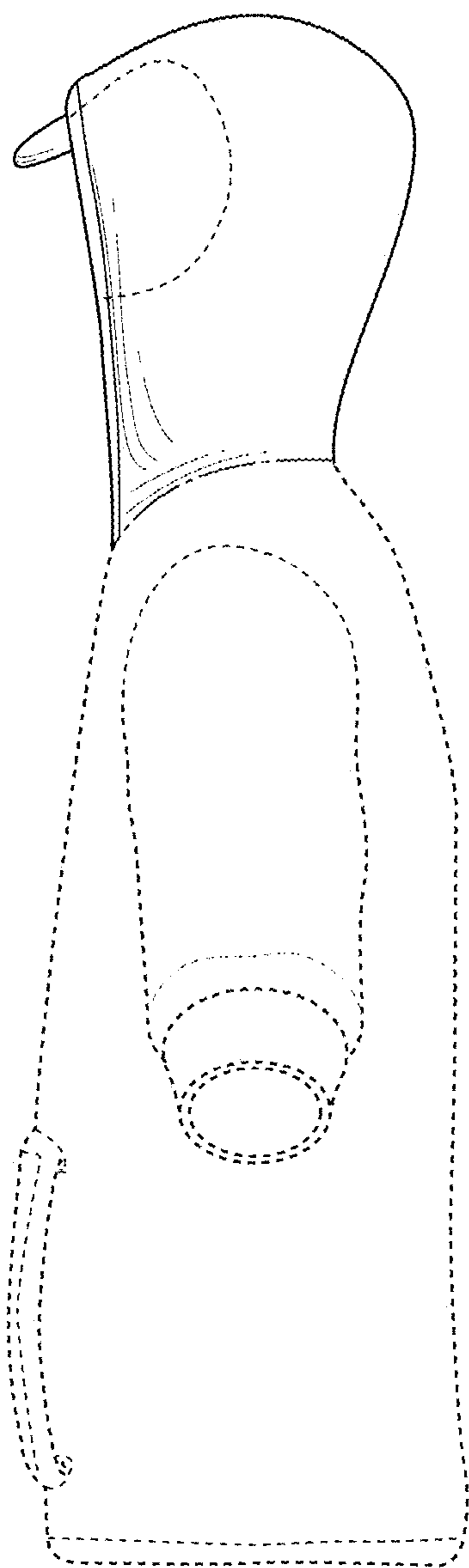

FIG. 5

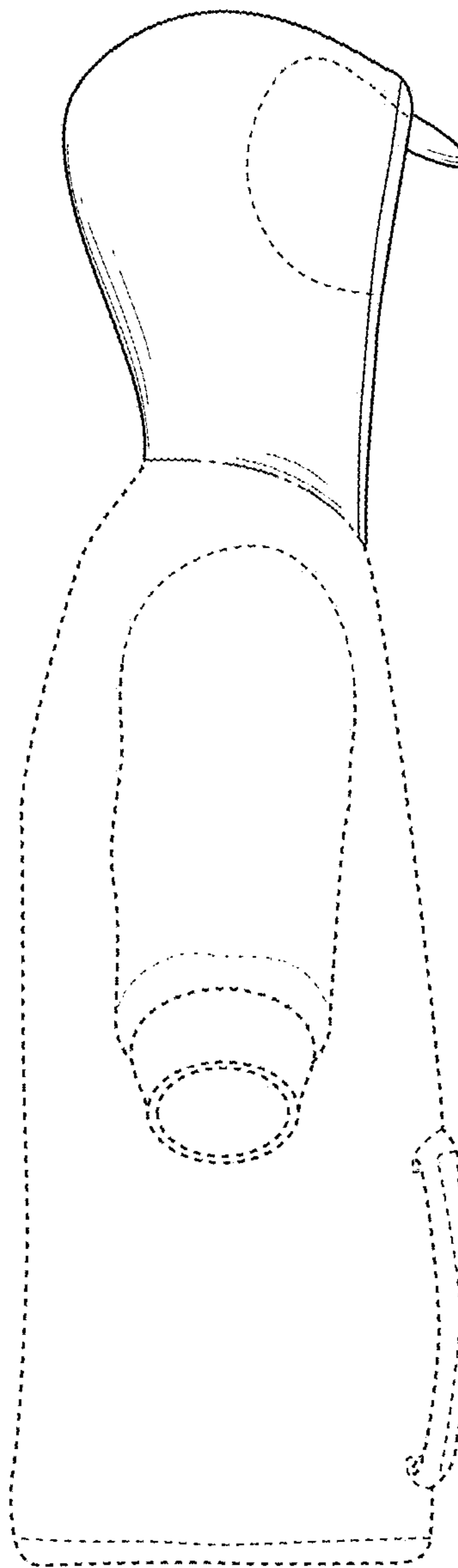

FIG. 6



FIG. 7

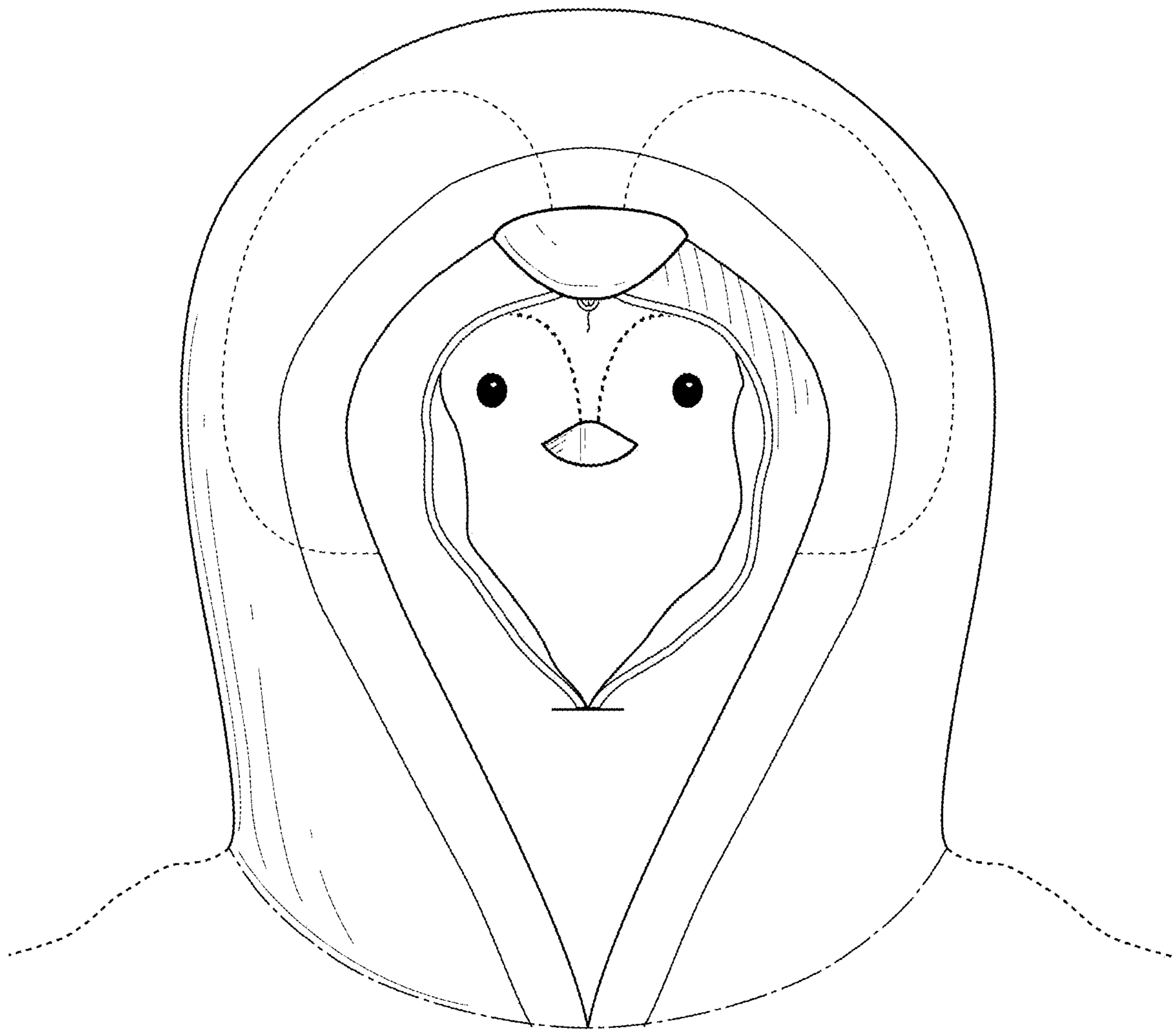

FIG. 8