



US00D881522S

(12) **United States Design Patent**
Buonocore

(10) **Patent No.:** **US D881,522 S**
(45) **Date of Patent:** **** Apr. 21, 2020**

(54) **PANDA SWEATSHIRT HOOD**

(71) Applicant: **Ontel Products Corporation**, Fairfield, NJ (US)

(72) Inventor: **Carly Buonocore**, Lincoln Park, NJ (US)

(73) Assignee: **ONTEL PRODUCTS CORPORATION**, Fairfield, NJ (US)

(**) Term: **15 Years**

(21) Appl. No.: **29/680,252**

(22) Filed: **Feb. 14, 2019**

(51) **LOC (12) Cl.** **02-02**

(52) **U.S. Cl.**
USPC **D2/831; D2/878**

(58) **Field of Classification Search**
USPC D2/728, 823, 824, 825, 826, 828, 831, D2/865, 866, 867, 870, 874, 877, 878, D2/880, 881, 887, 891, 892, 895; D5/13, D5/14, 20, 63, 64, 65; D6/598; D21/659, 660; D29/102, 108
CPC A41D 3/02; A41D 11/00; A41D 15/005; A41D 15/04; A41D 2200/20; A41D 27/08; A42B 1/00; A42B 1/006; A42B 1/04; A42B 1/041; A42B 1/045; A42B 1/046; A42B 1/048; A42B 7/00; A47G 9/1045; A63H 3/00
See application file for complete search history.

(56) **References Cited**

U.S. PATENT DOCUMENTS

4,543,669 A 10/1985 Katz
D285,815 S * 9/1986 Finn D2/741
(Continued)

OTHER PUBLICATIONS

Papo the Panda, [on-line]; [Review published on Nov. 4, 2018]; [retrieved from the Internet on Apr. 1, 2019]; URL: <https://cubcoats.com/collections/signature-series/products/papo-the-panda>. (2 pgs). (Year: 2018).*

(Continued)

Primary Examiner — Jasmine Mlinarcik
(74) *Attorney, Agent, or Firm* — Dickinson Wright PLLC

(57) **CLAIM**

I claim the ornamental design for a panda sweatshirt hood, as shown and described.

DESCRIPTION

FIG. 1 is a front perspective view of a panda sweatshirt hood;
FIG. 2 is a front view of the panda sweatshirt hood of FIG. 1;
FIG. 3 is a rear view of the panda sweatshirt hood of FIG. 1;
FIG. 4 is a top view of the panda sweatshirt hood of FIG. 1;
FIG. 5 is a right side view of the panda sweatshirt hood of FIG. 1;
FIG. 6 is a left side view of the panda sweatshirt hood of FIG. 1;
FIG. 7 is a front view of the panda sweatshirt hood of FIG. 1 in a laid-flat position with a zipper in an open position; and
FIG. 8 is a front view of the panda sweatshirt hood of FIG. 1 with a zipper in an open position.
The zipper follows the curvature of the panda sweatshirt hood. The facial features are an applied motif that follows the curvature of the panda sweatshirt hood. The dash-dot-dash broken line defines the bounds of the claim and forms no part of the claimed design. The even-length broken lines along the hood portion of the panda sweatshirt hood depict features that form no part of the claimed design. The even-length broken lines beyond the boundary line depicts portions of the panda sweatshirt hood that form no part of the claimed design.

1 Claim, 7 Drawing Sheets

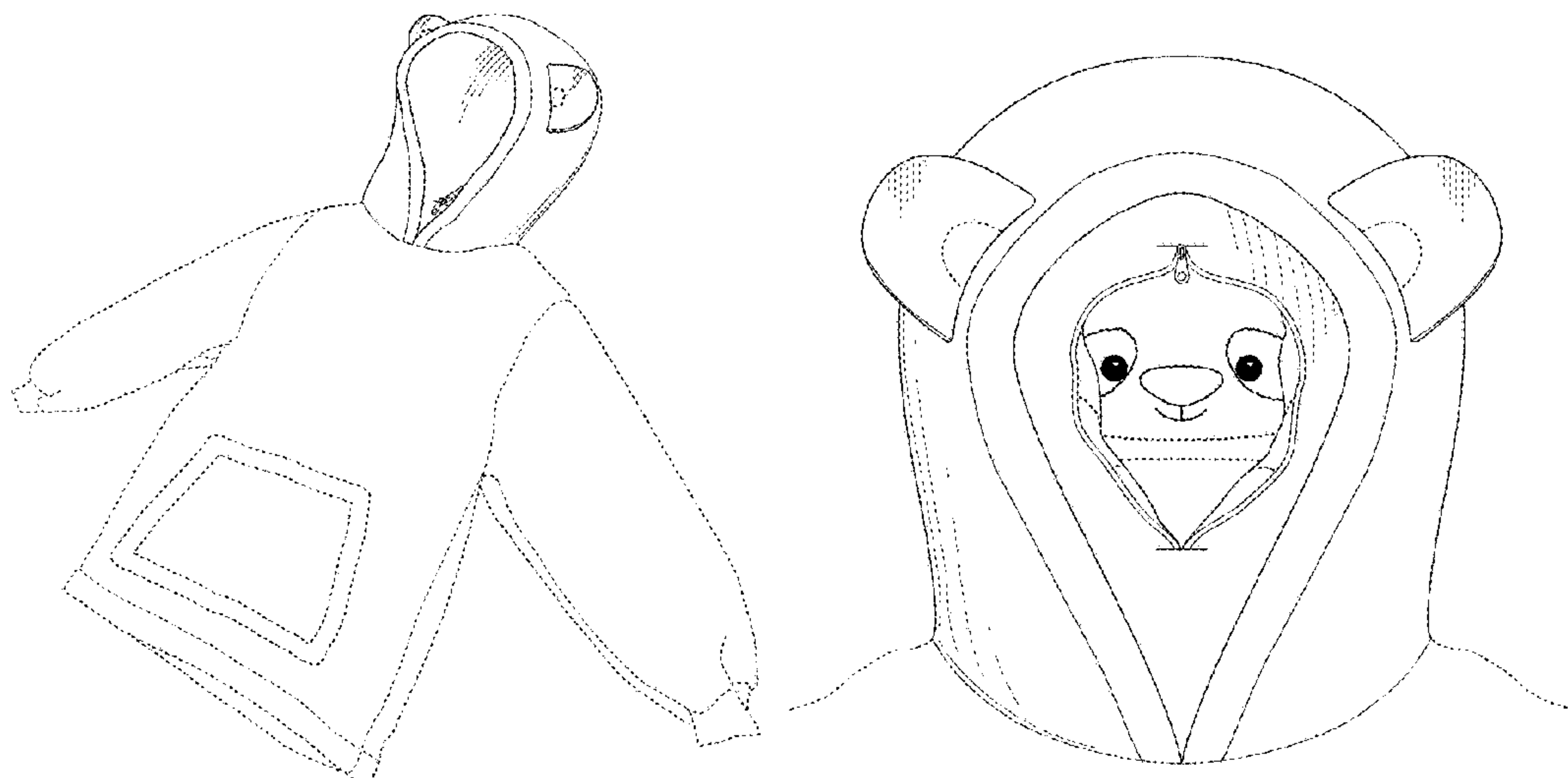

(56)

References Cited

U.S. PATENT DOCUMENTS

D325,296	S *	4/1992	Wu	D2/872
D406,936	S *	3/1999	Sivret	D2/865
D522,788	S *	6/2006	Keller	D6/598
D551,429	S *	9/2007	Wager	D2/831
D589,682	S *	4/2009	Knab	D2/869
D663,105	S *	7/2012	Selivon	D2/870
D672,534	S *	12/2012	Smith	D2/878
8,864,544	B2 *	10/2014	Anderman	A63H 3/003 2/75
D761,524	S *	7/2016	Cook	D2/878
9,936,746	B1	4/2018	Park		
D836,302	S *	12/2018	Alba	D2/867
2004/0181844	A1 *	9/2004	Kim	A41D 3/02 2/93
2008/0115254	A1	5/2008	Galkov		
2014/0237700	A1	8/2014	Albert		
2015/0121604	A1	5/2015	Lee et al.		
2017/0065109	A1 *	3/2017	Peel	A63H 3/02
2018/0132551	A1	5/2018	Holder, III		

OTHER PUBLICATIONS

Rainbow Bear Hat . . . [on-lien]; [review published to the Internet on Nov. 15, 2017]; [retrieved from the Internet on Apr. 1, 2019]; URL:https://www.etsy.com/in-en/listing/387068464/rainbow-bear-hat-pastel-rainbow-bear?ref=shop_review. (2 pgs). (Year: 2017).*
Cubcoats website; <https://cubcoats.com/collections/cubcoats>; 4 pages; accessed Jan. 24, 2019.

* cited by examiner

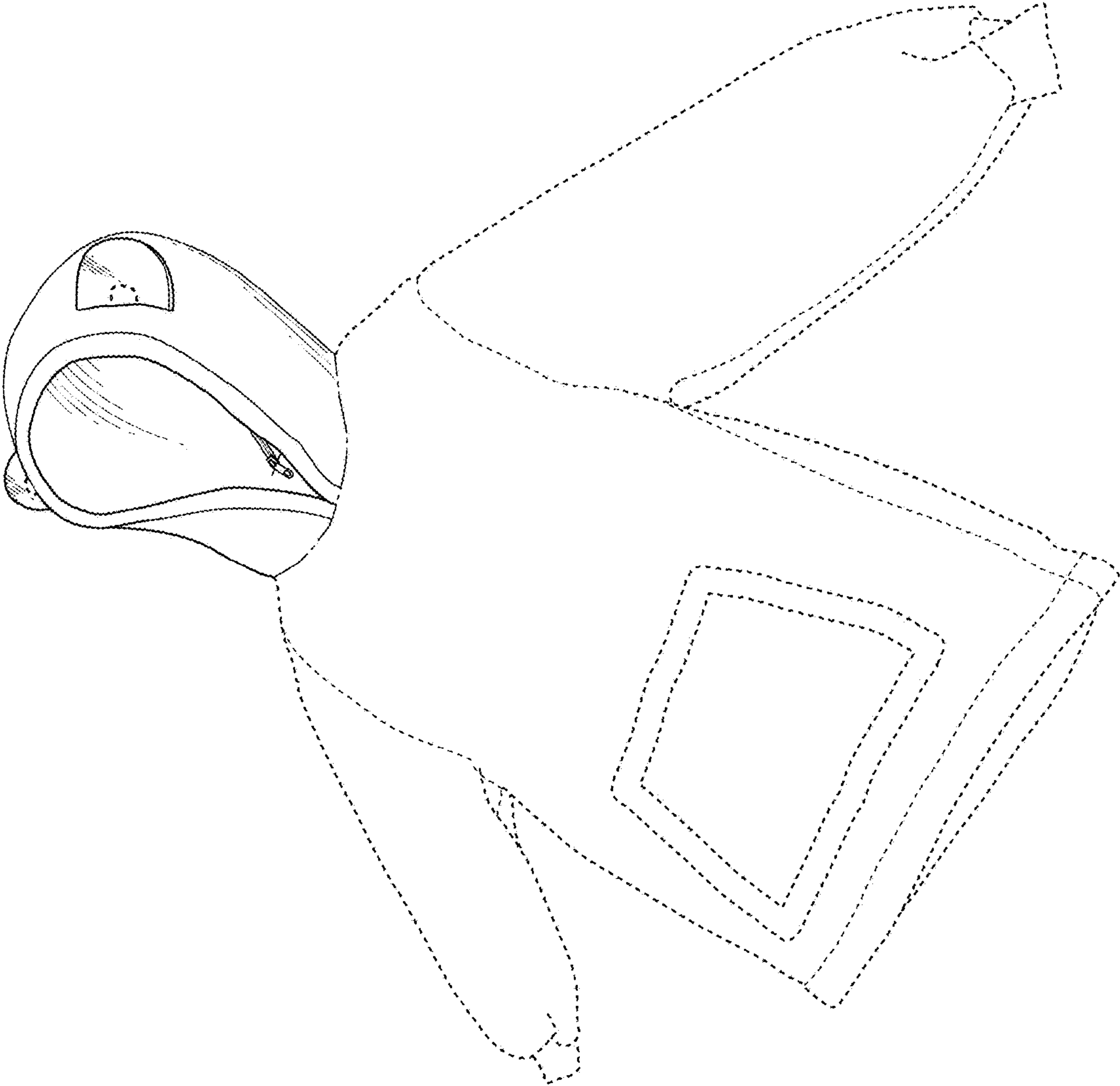

FIG. 1

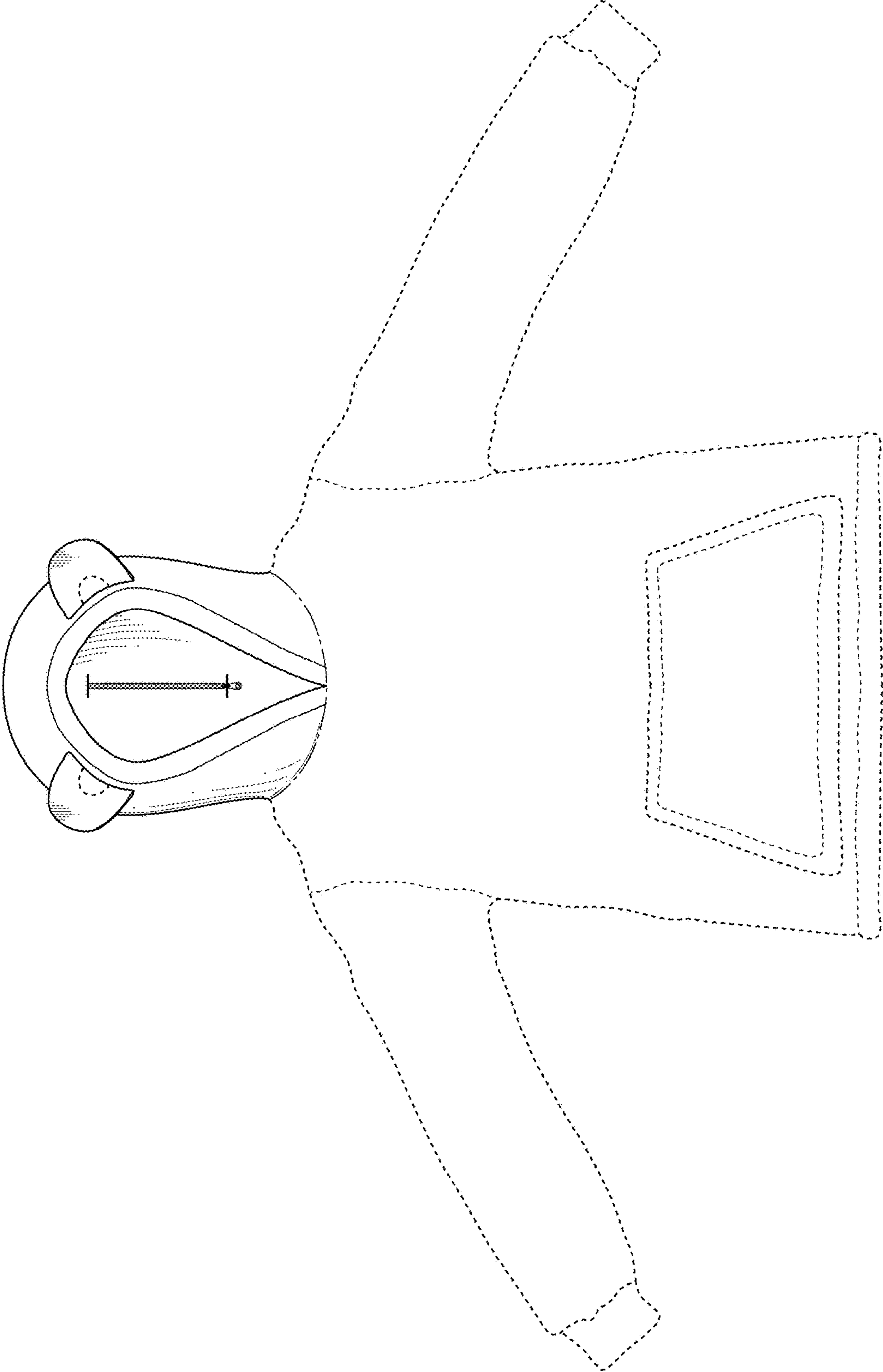

FIG. 2

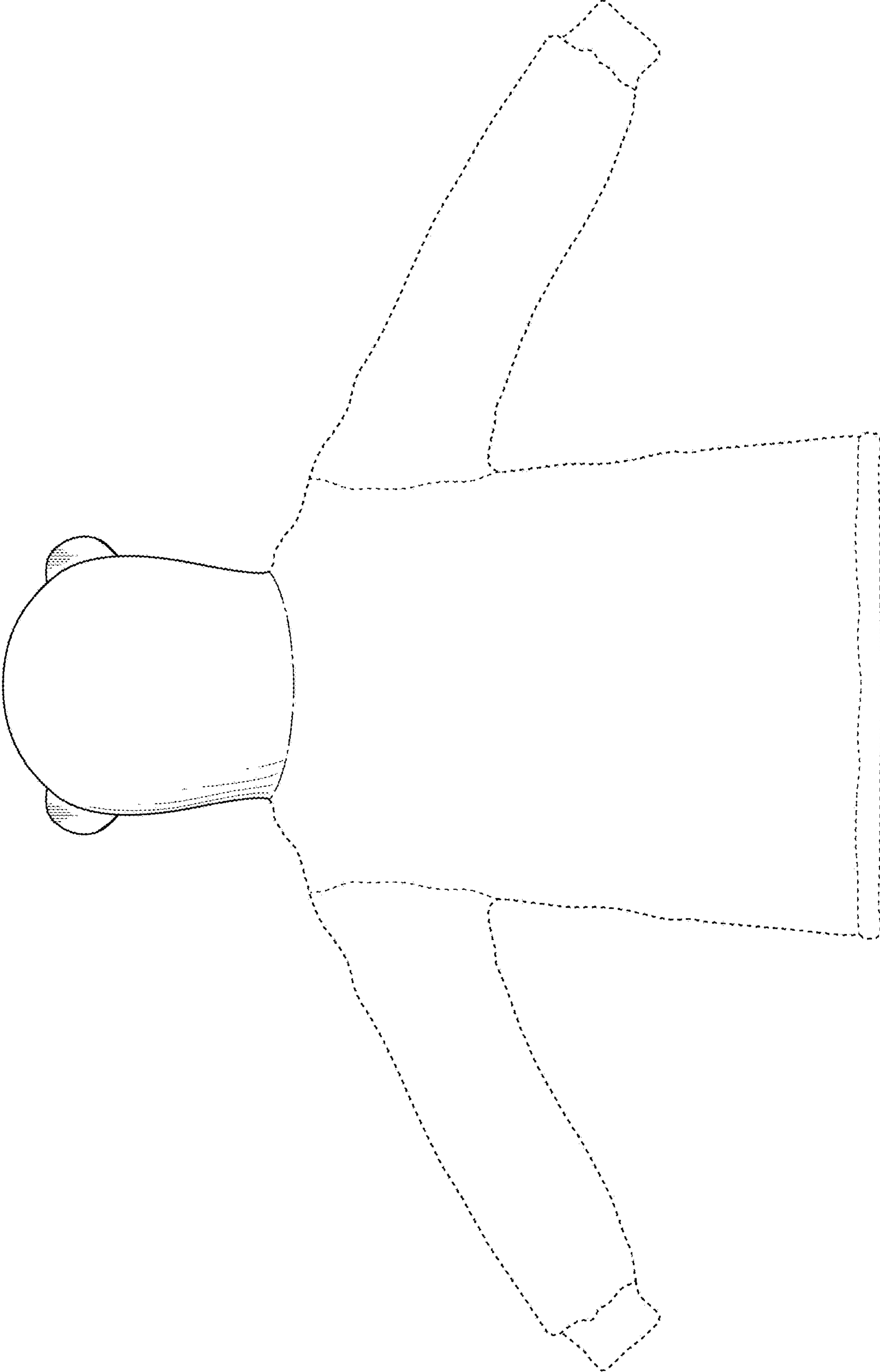

FIG. 3

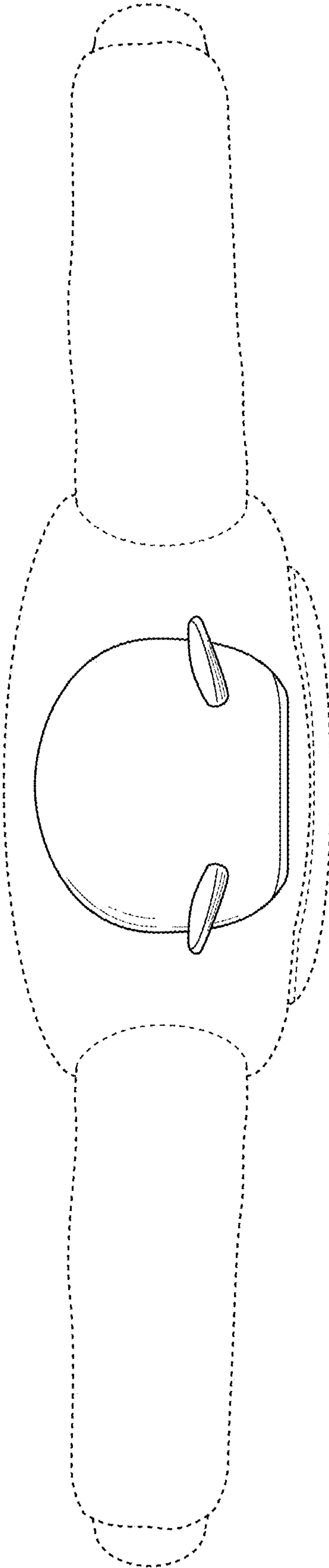

FIG. 4

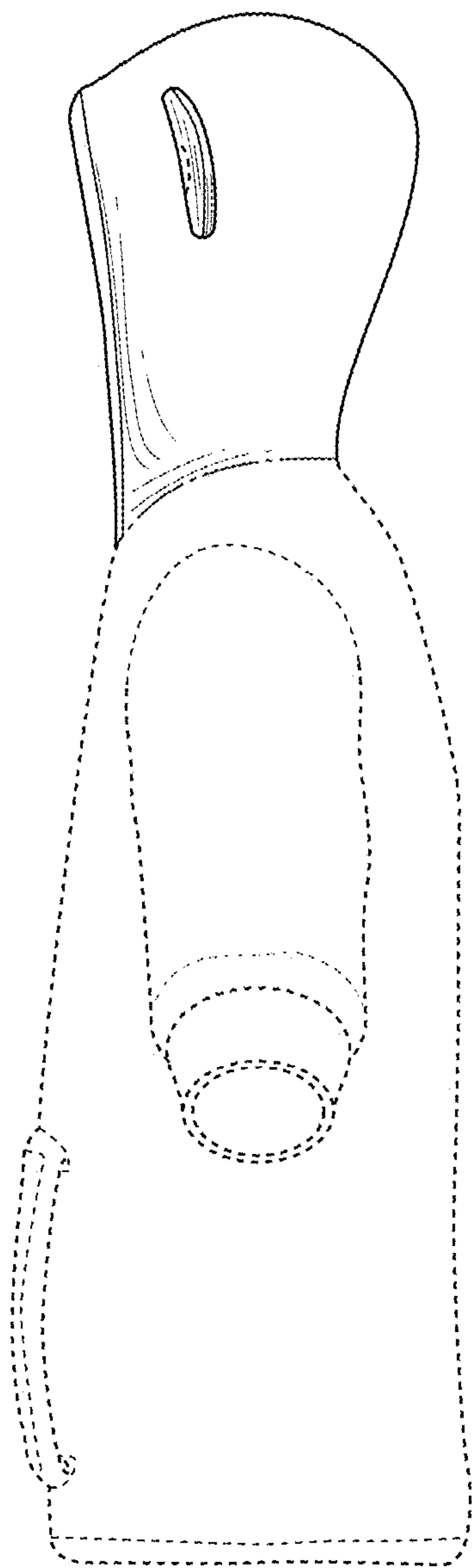

FIG. 5

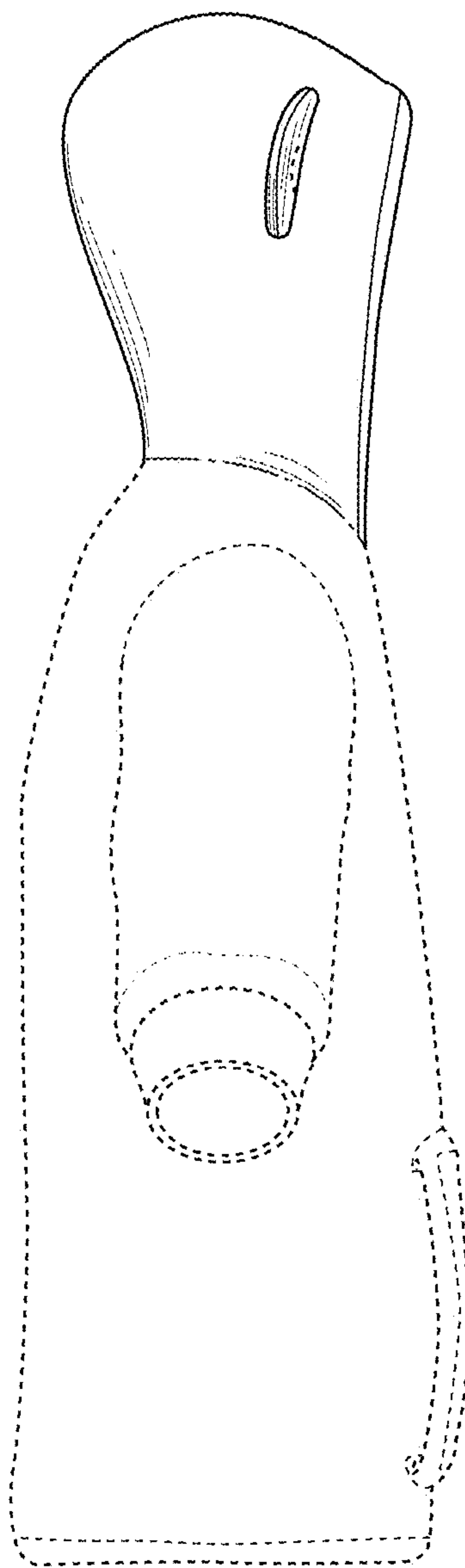

FIG. 6

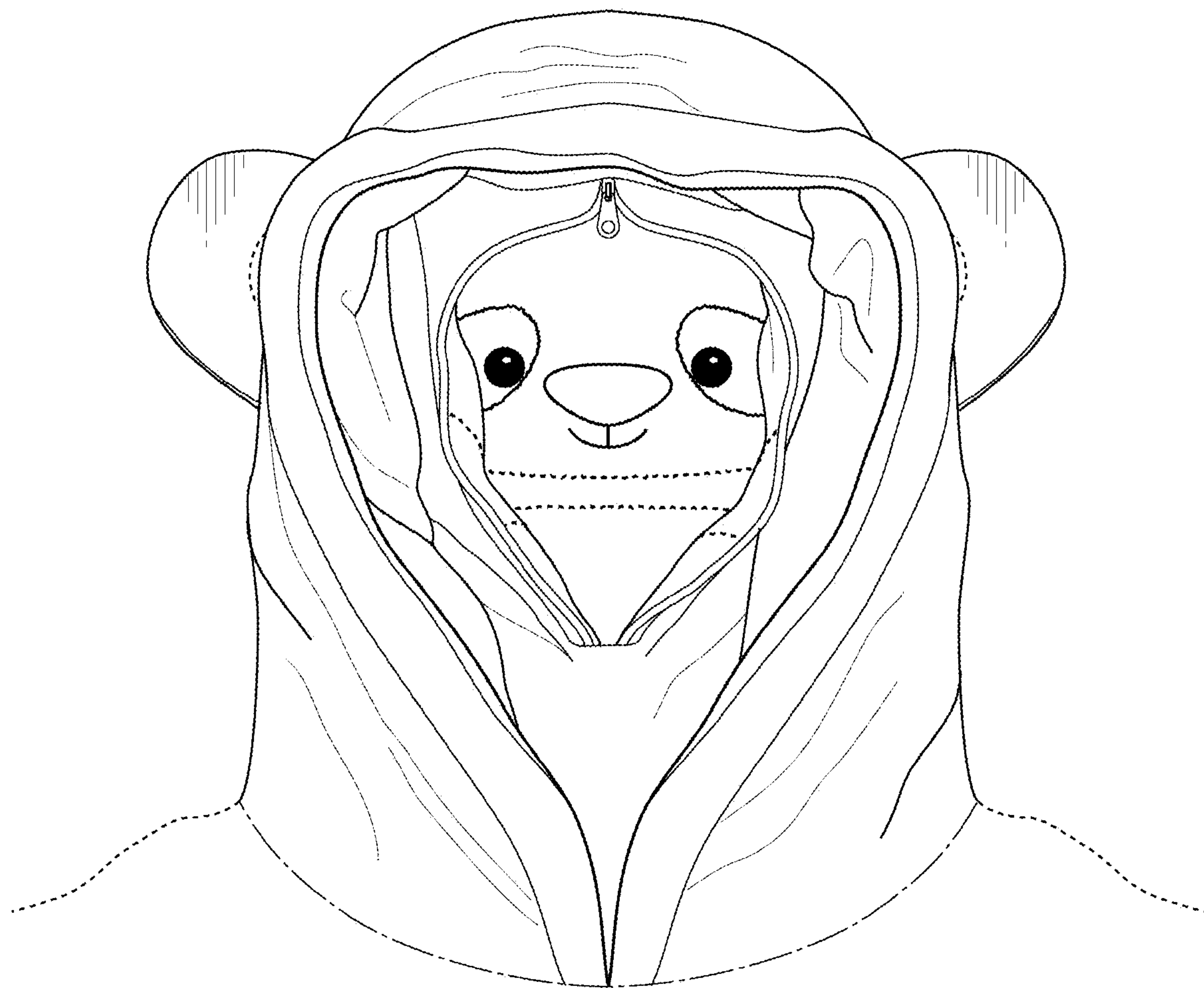

FIG. 7

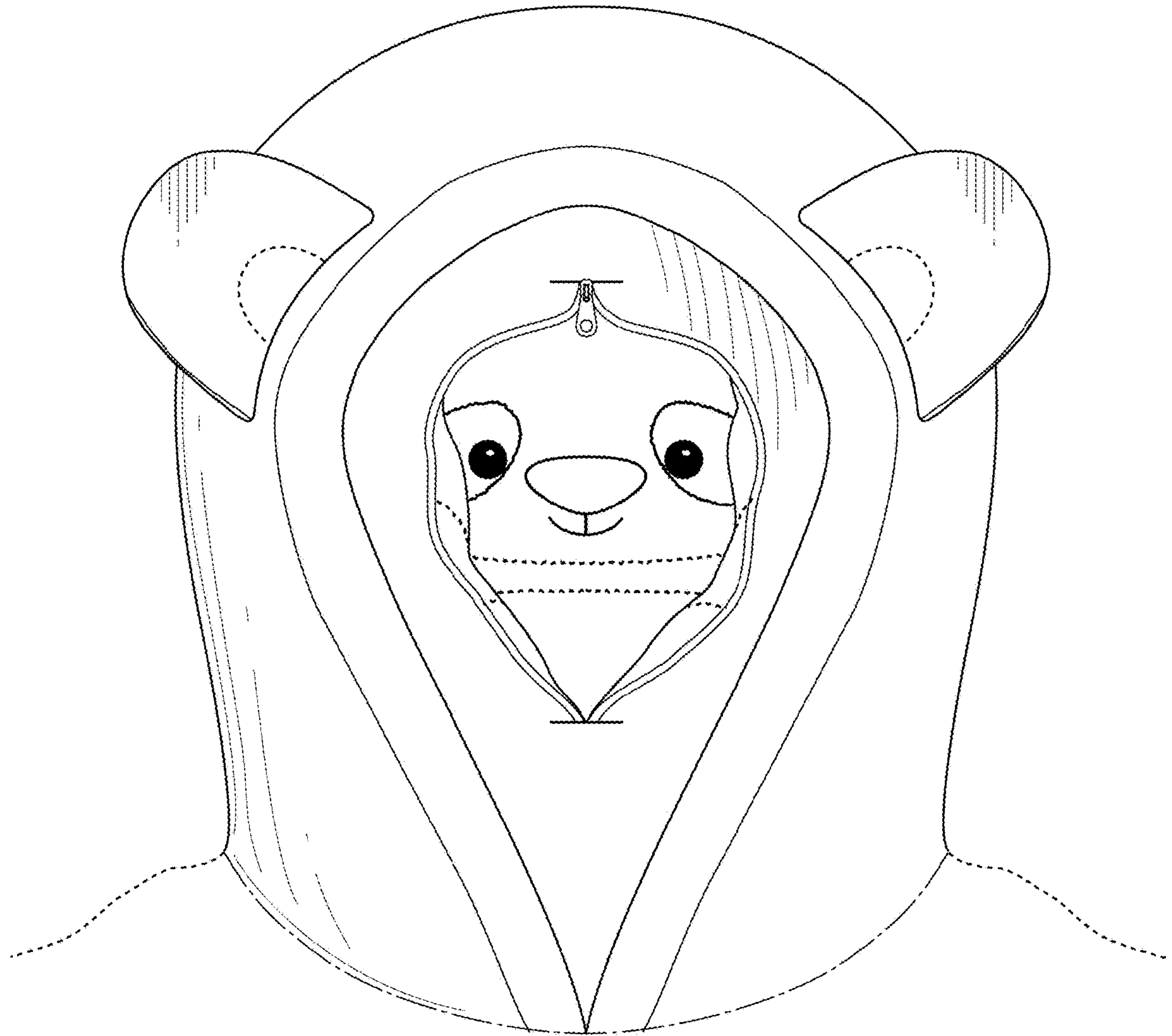

FIG. 8