



US00D881520S

(12) **United States Design Patent**
Buonocore

(10) **Patent No.:** **US D881,520 S**
(45) **Date of Patent:** **** Apr. 21, 2020**

(54) **UNICORN SWEATSHIRT HOOD**

(71) Applicant: **Ontel Products Corporation**, Fairfield, NJ (US)

(72) Inventor: **Carly Buonocore**, Lincoln Park, NJ (US)

(73) Assignee: **ONTEL PRODUCTS CORPORATION**, Fairfield, NJ (US)

(**) Term: **15 Years**

(21) Appl. No.: **29/680,243**

(22) Filed: **Feb. 14, 2019**

(51) **LOC (12) Cl.** **02-02**

(52) **U.S. Cl.**

USPC **D2/831; D2/878**

(58) **Field of Classification Search**

USPC D2/728, 823, 824, 825, 826, 828, 831, D2/865, 866, 867, 870, 874, 877, 878, D2/880, 881, 887, 891, 892, 895; D5/13, D5/14, 20, 63, 64, 65; D6/598; D21/659, 660; D29/102, 108

CPC A41D 3/02; A41D 11/00; A41D 15/005; A41D 15/04; A41D 2200/20; A41D 27/08; A42B 1/00; A42B 1/006; A42B 1/04; A42B 1/041; A42B 1/045; A42B 1/046; A42B

(Continued)

(56) **References Cited**

U.S. PATENT DOCUMENTS

885,802 A * 4/1908 Sterrick A41D 13/11 2/206
D167,790 S * 9/1952 Adams 2/205
4,543,669 A 10/1985 Katz

(Continued)

OTHER PUBLICATIONS

Crochet Unicorn Hat Pattern . . . [on-line article]; [review published to the Internet on Oct. 5, 2018]; [retrieved from the Internet on Apr.

1, 2019]; URL: https://www.etsy.com/in-en/listing/512818259/crochet-unicorn-hat-pattern-slouchy?ref=shop_review. (2 pgs). (Year: 2018).*

Primary Examiner — Jasmine Mlinarcik

(74) *Attorney, Agent, or Firm* — Dickinson Wright PLLC

(57) **CLAIM**

I claim the ornamental design for a unicorn sweatshirt hood, as shown and described.

DESCRIPTION

FIG. 1 is a front perspective view of a unicorn sweatshirt hood;

FIG. 2 is a front view of the unicorn sweatshirt hood of FIG. 1;

FIG. 3 is a rear view of the unicorn sweatshirt hood of FIG. 1;

FIG. 4 is a top view of the unicorn sweatshirt hood of FIG. 1;

FIG. 5 is a right side view of the unicorn sweatshirt hood of FIG. 1;

FIG. 6 is a left side view of the unicorn sweatshirt hood of FIG. 1;

FIG. 7 is a front view of the unicorn sweatshirt hood of FIG. 1 in a laid-flat position with a zipper in an open position; and,

FIG. 8 is a front view of the unicorn sweatshirt hood of FIG. 1 with a zipper in an open position.

The zipper follows the curvature of the unicorn sweatshirt hood. The facial features are an applied motif that follows the curvature of the unicorn sweatshirt hood.

The dash-dot-dash broken line defines the bounds of the claim and forms no part of the claimed design. The even-length broken line along the hood portion of the unicorn sweatshirt hood depicts a feature line that forms no part of the claimed design. The even-length broken lines beyond the boundary line depicts portions of the unicorn sweatshirt hood that form no part of the claimed design.

1 Claim, 7 Drawing Sheets

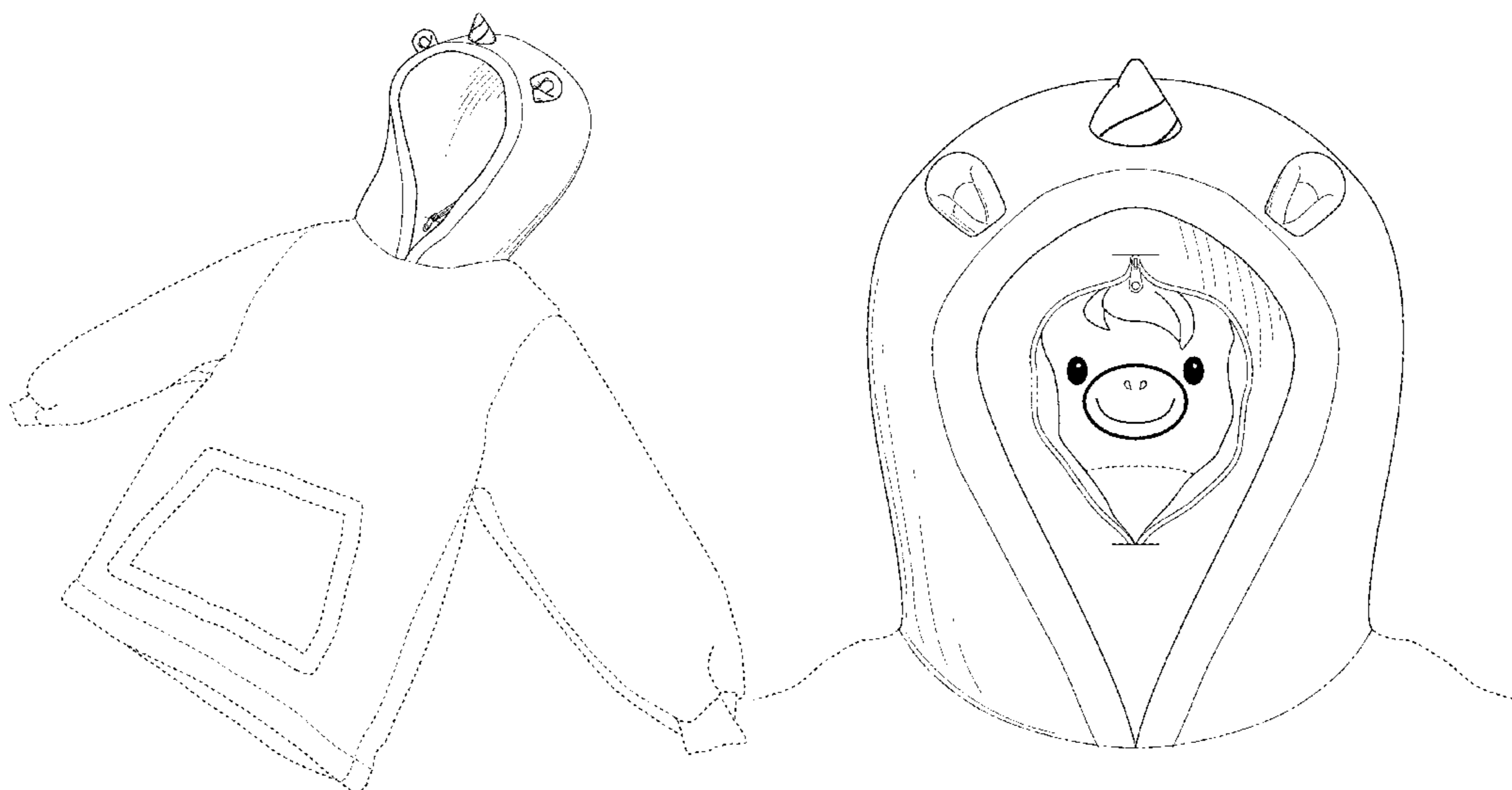

(58) **Field of Classification Search**

CPC 1/048; A42B 7/00; A47G 9/1045; A63H
3/00

See application file for complete search history.

(56) **References Cited**

U.S. PATENT DOCUMENTS

D282,598	S *	2/1986	Chiang	D2/871
D284,328	S *	6/1986	Bieber	D11/134
D408,197	S *	4/1999	Bear	D21/620
D411,239	S *	6/1999	Jack	D2/869
D508,811	S *	8/2005	Bourget	D21/618
D589,681	S *	4/2009	Knab	D2/869
D597,716	S *	8/2009	Wen	D21/659
D672,534	S *	12/2012	Smith	D2/878
D680,787	S *	4/2013	Diaz	D21/620
8,864,544	B2 *	10/2014	Anderman	A63H 3/003 2/75
9,936,746	B1	4/2018	Park		
D836,302	S *	12/2018	Alba	D2/867
2008/0115254	A1	5/2008	Galkov		
2012/0276802	A1 *	11/2012	Anderman	A63H 3/003 446/27
2014/0237700	A1	8/2014	Albert		
2015/0121604	A1	5/2015	Lee et al.		
2018/0132551	A1	5/2018	Holder, III		

* cited by examiner

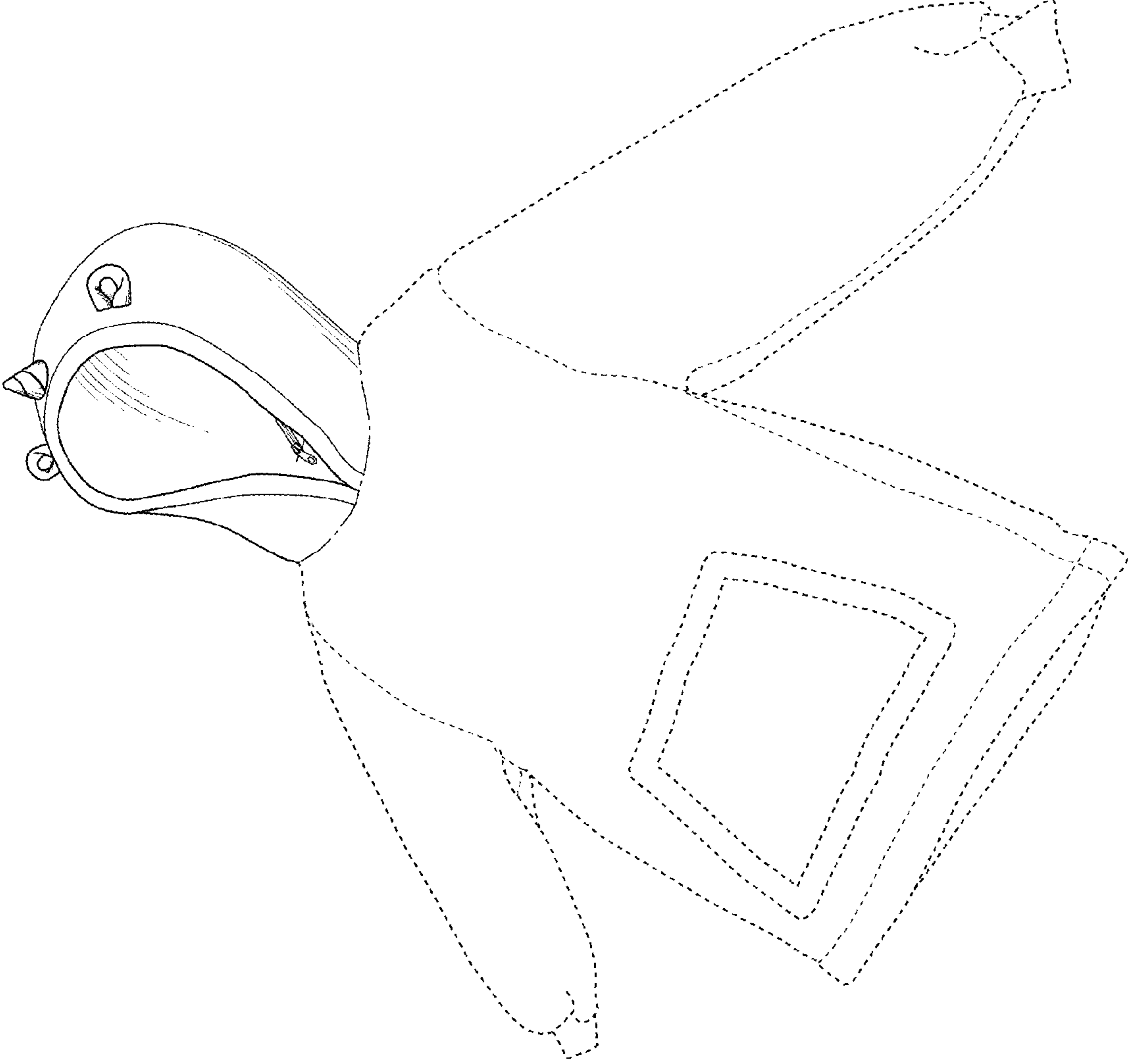

FIG. 1

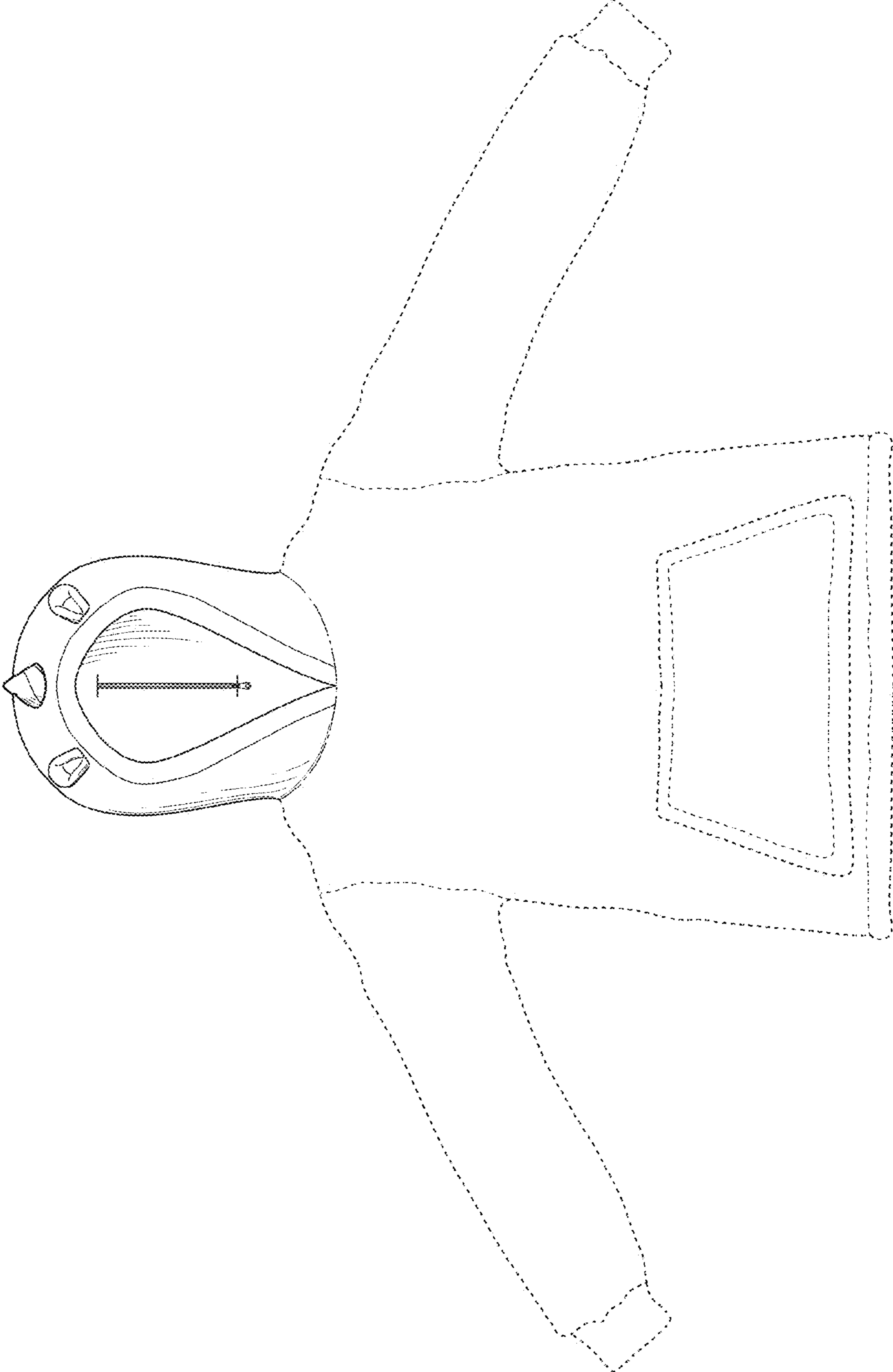

FIG. 2

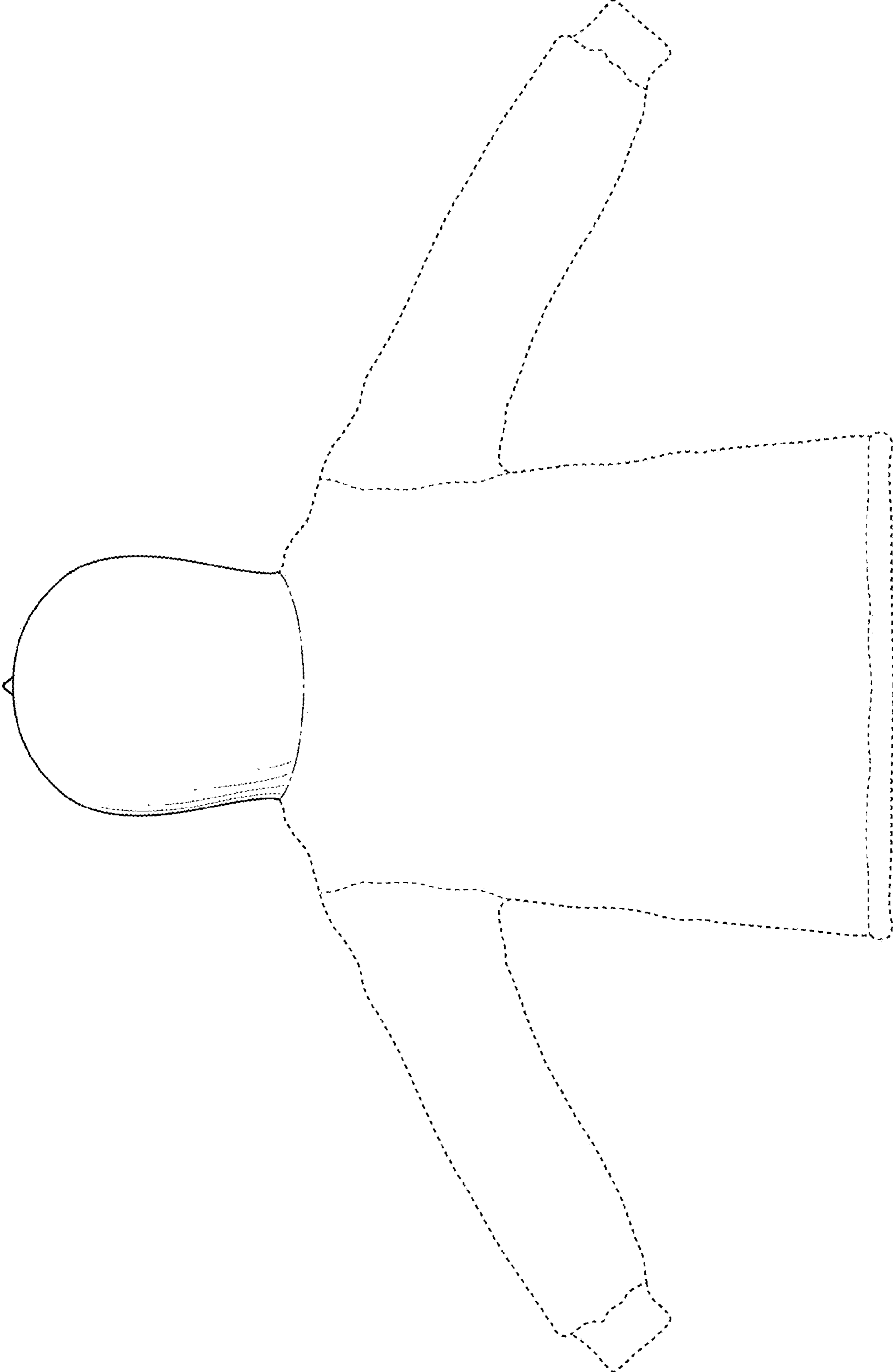

FIG. 3

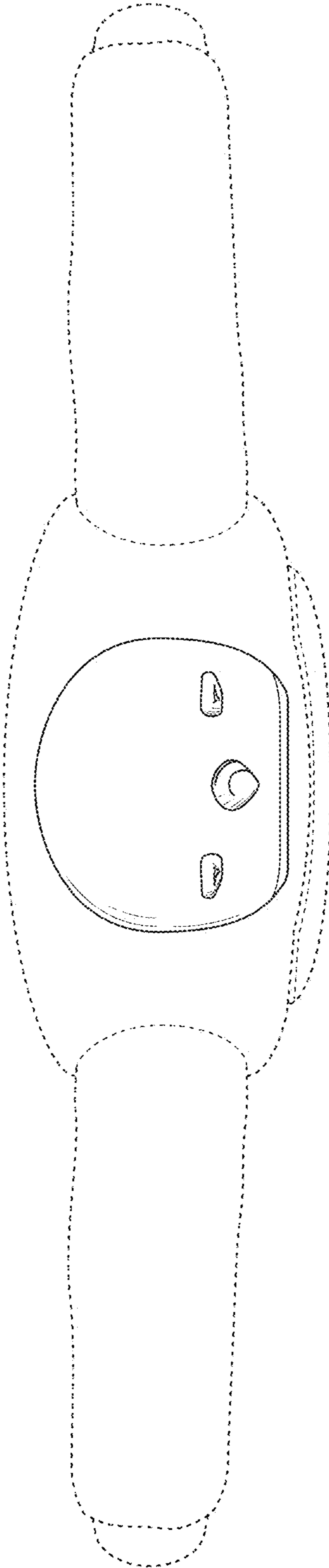

FIG. 4

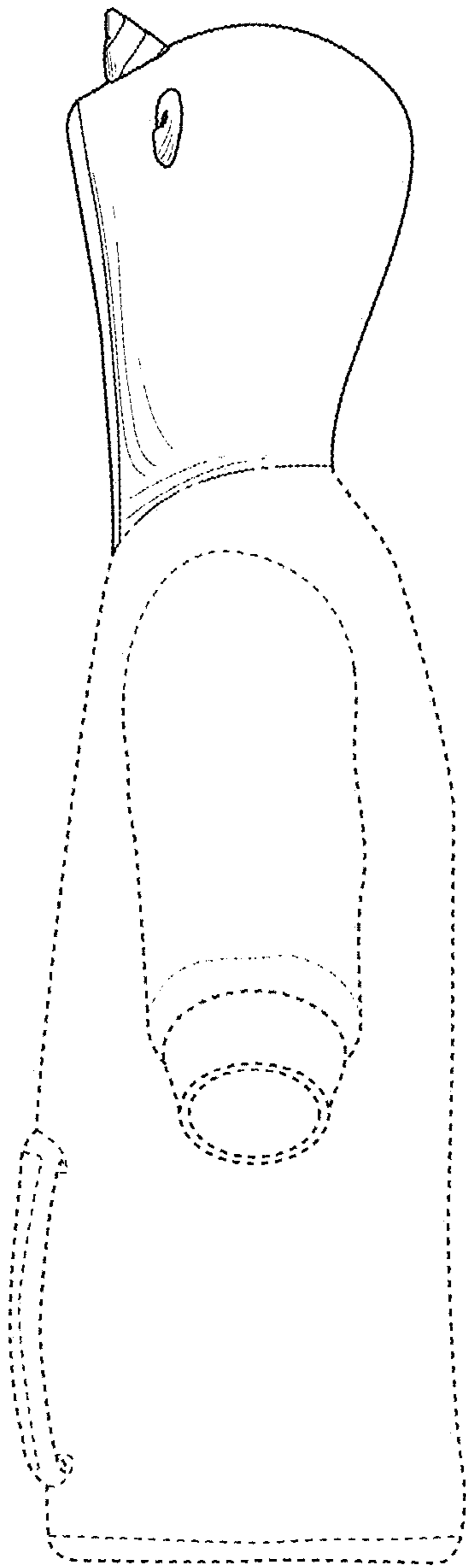

FIG. 5

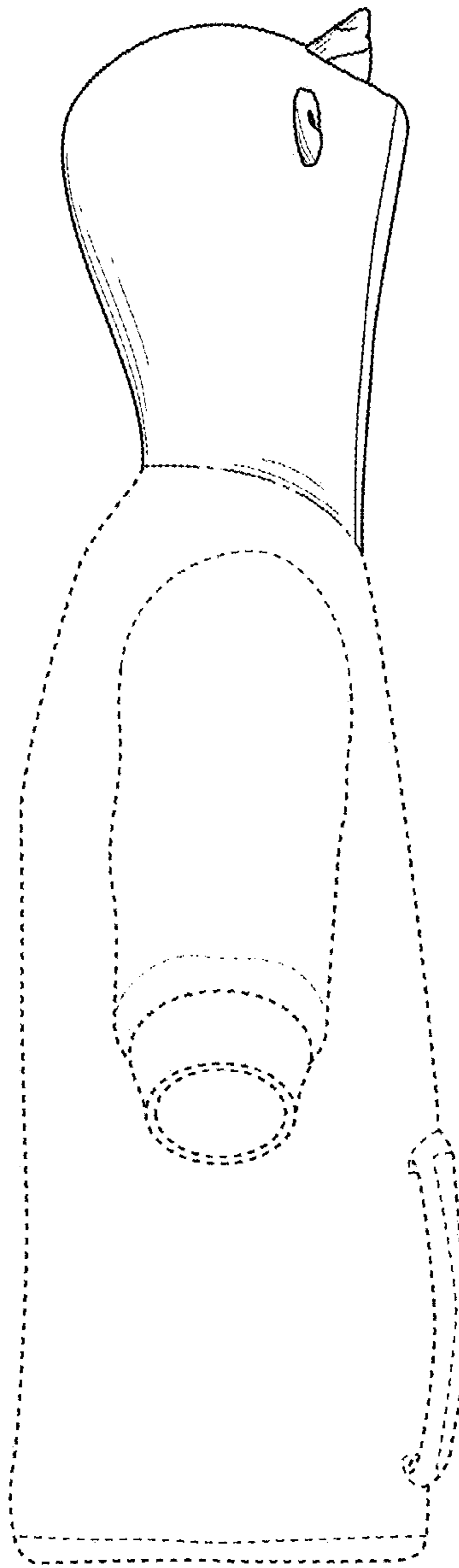

FIG. 6



FIG. 7



FIG. 8