



US00D881519S

(12) **United States Design Patent**
Buonocore

(10) **Patent No.:** **US D881,519 S**

(45) **Date of Patent:** **** Apr. 21, 2020**

(54) **DOG SWEATSHIRT HOOD**

(71) Applicant: **Ontel Products Corporation**, Fairfield, NJ (US)

(72) Inventor: **Carly Buonocore**, Lincoln Park, NJ (US)

(73) Assignee: **ONTEL PRODUCTS CORPORATION**, Fairfield, NJ (US)

(**) Term: **15 Years**

(21) Appl. No.: **29/680,240**

(22) Filed: **Feb. 14, 2019**

(51) **LOC (12) Cl.** **02-02**

(52) **U.S. Cl.**
USPC **D2/831; D2/878**

(58) **Field of Classification Search**
USPC D2/728, 823, 824, 825, 826, 828, 831, D2/865, 866, 867, 870, 874, 877, 878, D2/880, 881, 887, 891, 892, 895; D5/13, D5/14, 20, 63, 64, 65; D6/598; D21/659, 660; D29/102, 108
CPC A41D 3/02; A41D 11/00; A41D 15/005; A41D 15/04; A41D 2200/20; A41D 27/08; A42B 1/00; A42B 1/006; A42B 1/04; A42B 1/041; A42B 1/045; A42B 1/046; A42B

(Continued)

(56) **References Cited**

U.S. PATENT DOCUMENTS

4,543,669 A 10/1985 Katz
D285,815 S * 9/1986 Finn D2/741
D482,242 S * 11/2003 Yamane D2/831

(Continued)

OTHER PUBLICATIONS

Primm the Puppy, [on-line]; [review posted to the Internet on Oct. 18, 2018]; [retrieved from the Internet on Apr. 1, 2019]; URL: <https://cubcoats.com/collections/signature-series/products/pimm-the-puppy>. (2 pgs). (Year: 2018).*

(Continued)

Primary Examiner — Jasmine Mlinarcik

(74) *Attorney, Agent, or Firm* — Dickinson Wright PLLC

(57) **CLAIM**

I claim the ornamental design for a dog sweatshirt hood, as shown and described.

DESCRIPTION

FIG. 1 is a front perspective view of a dog sweatshirt hood; FIG. 2 is a front view of the dog sweatshirt hood of FIG. 1; FIG. 3 is a rear view of the dog sweatshirt hood of FIG. 1; FIG. 4 is a top view of the dog sweatshirt hood of FIG. 1; FIG. 5 is a right side view of the dog sweatshirt hood of FIG. 1; FIG. 6 is a left side view of the dog sweatshirt hood of FIG. 1; FIG. 7 is a front view of the dog sweatshirt hood of FIG. 1 in a laid-flat position with a zipper in an open position; and, FIG. 8 is a front view of the dog sweatshirt hood of FIG. 1 with a zipper in an open position.

The zipper follows the curvature of the dog sweatshirt hood. The facial features are an applied motif that follows the curvature of the dog sweatshirt hood.

The dash-dot-dash broken line defines the bounds of the claim and forms no part of the claimed design. The even-length broken line along the hood portion of the dog sweatshirt hood depicts a feature line that forms no part of the claimed design. The even-length broken lines beyond the boundary line depicts portions of the dog sweatshirt hood that form no part of the claimed design.

1 Claim, 7 Drawing Sheets

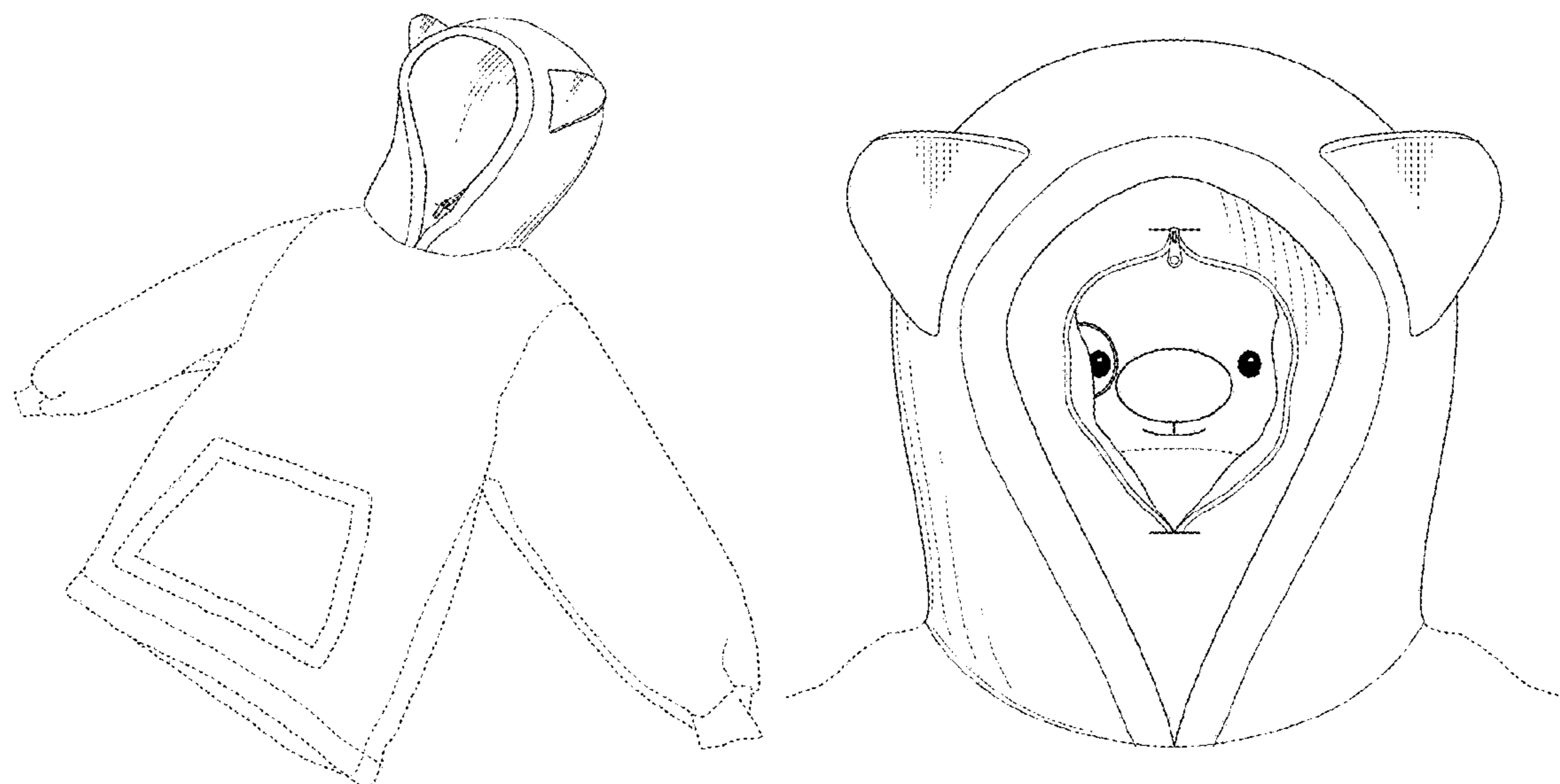

(58) **Field of Classification Search**

CPC 1/048; A42B 7/00; A47G 9/1045; A63H
3/00

See application file for complete search history.

(56) **References Cited**

U.S. PATENT DOCUMENTS

6,651,256 B1 * 11/2003 Swift A42B 1/004
2/15
D520,798 S * 5/2006 Keller D6/598
D551,429 S * 9/2007 Wager D2/831
7,302,710 B2 * 12/2007 Thomas A41D 1/04
2/84
D589,683 S * 4/2009 Knab D2/869
D672,534 S * 12/2012 Smith D2/878
D699,927 S * 2/2014 Fujioka D2/866
D761,524 S * 7/2016 Cook D2/878
9,936,746 B1 4/2018 Park
D836,302 S * 12/2018 Alba D2/867
2004/0181844 A1 * 9/2004 Kim A41D 3/02
2/93
2008/0115254 A1 5/2008 Galkov
2014/0237700 A1 8/2014 Albert
2015/0121604 A1 5/2015 Lee et al.
2018/0132551 A1 5/2018 Holder, III
2018/0352879 A1 * 12/2018 Goulina A41D 15/04

OTHER PUBLICATIONS

Cubcoats website; <https://cubcoats.com/collections/cubcoats>; 4 pages;
accessed Jan. 24, 2019.

* cited by examiner

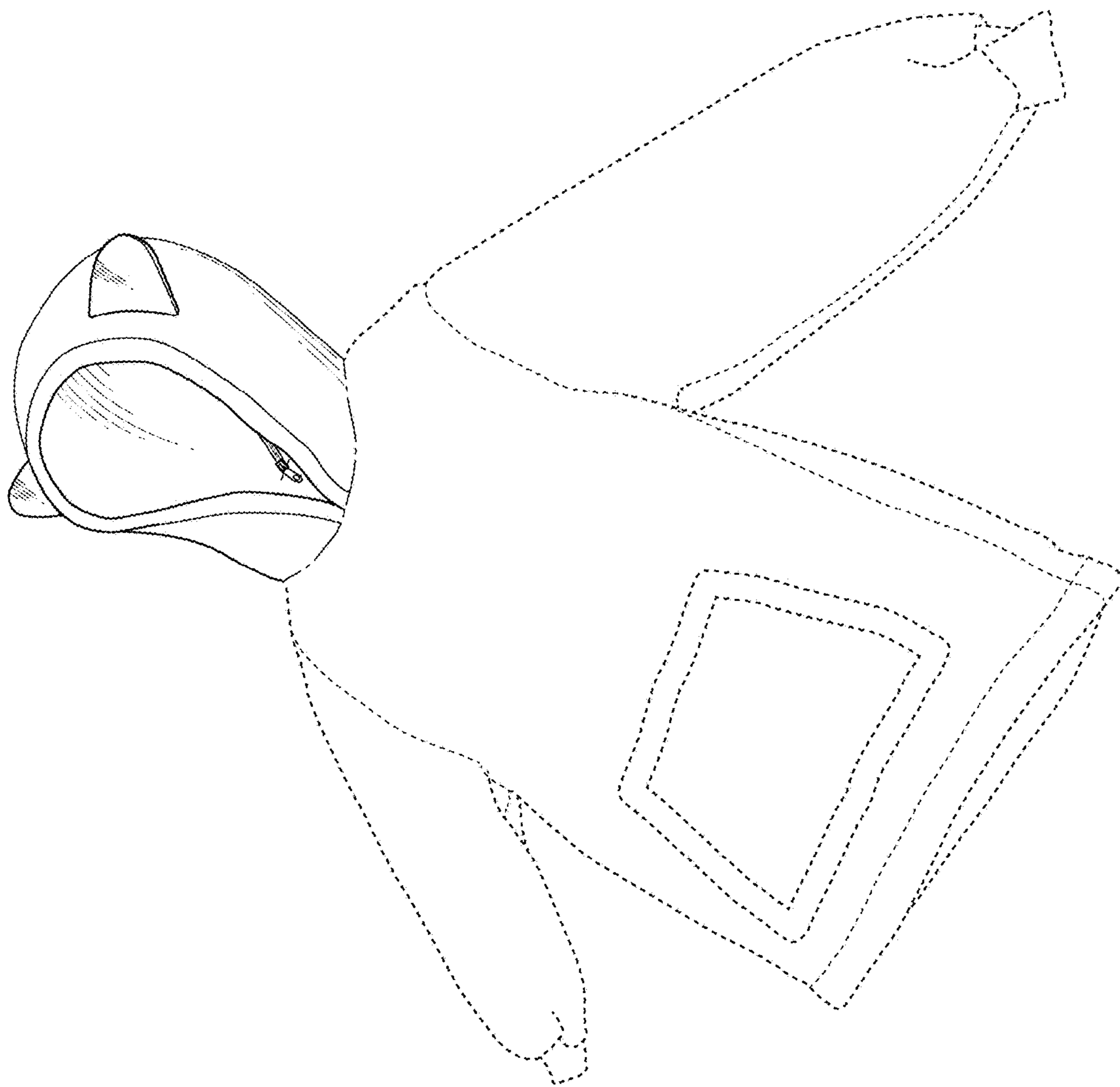

FIG. 1

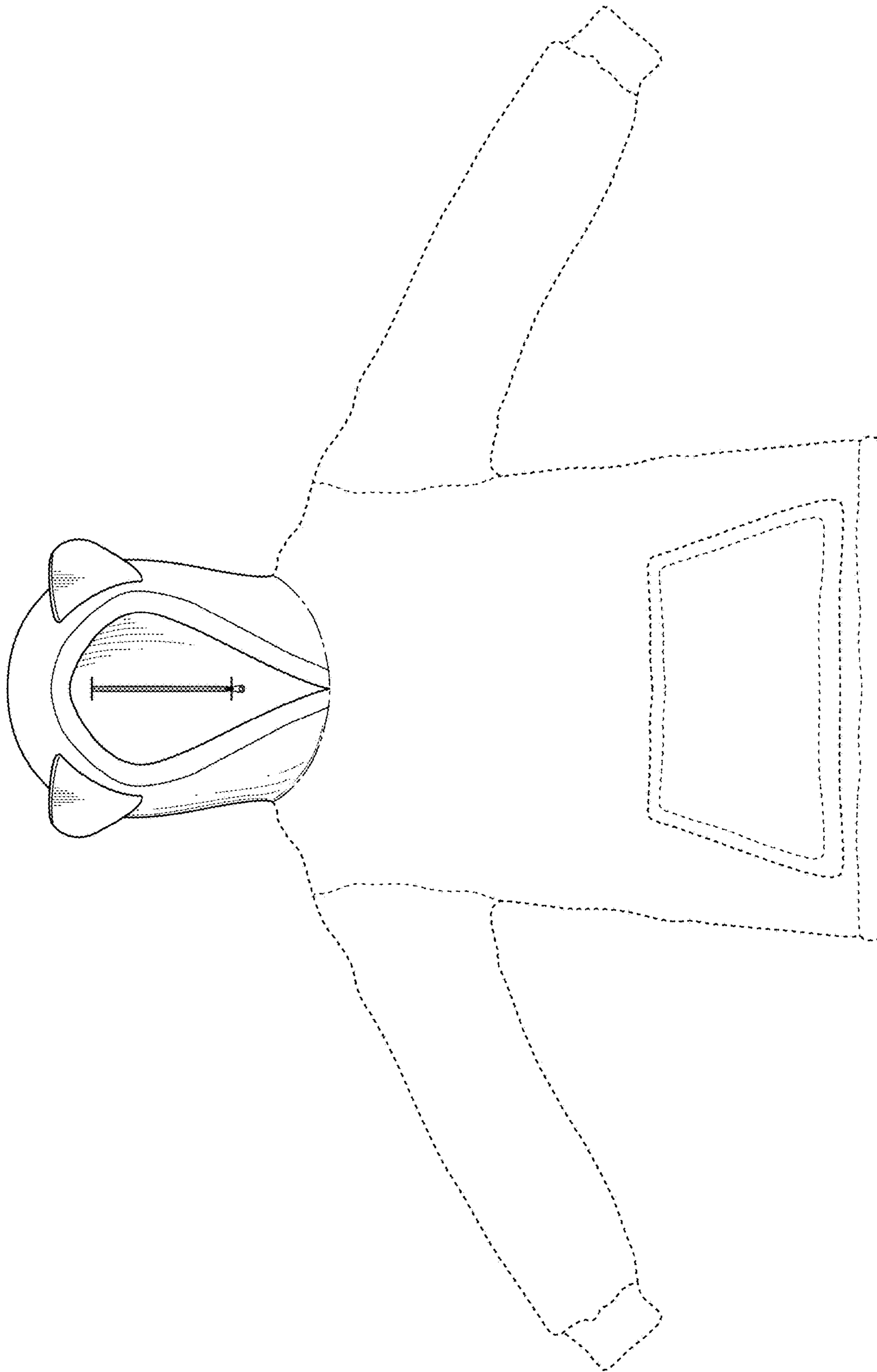

FIG. 2

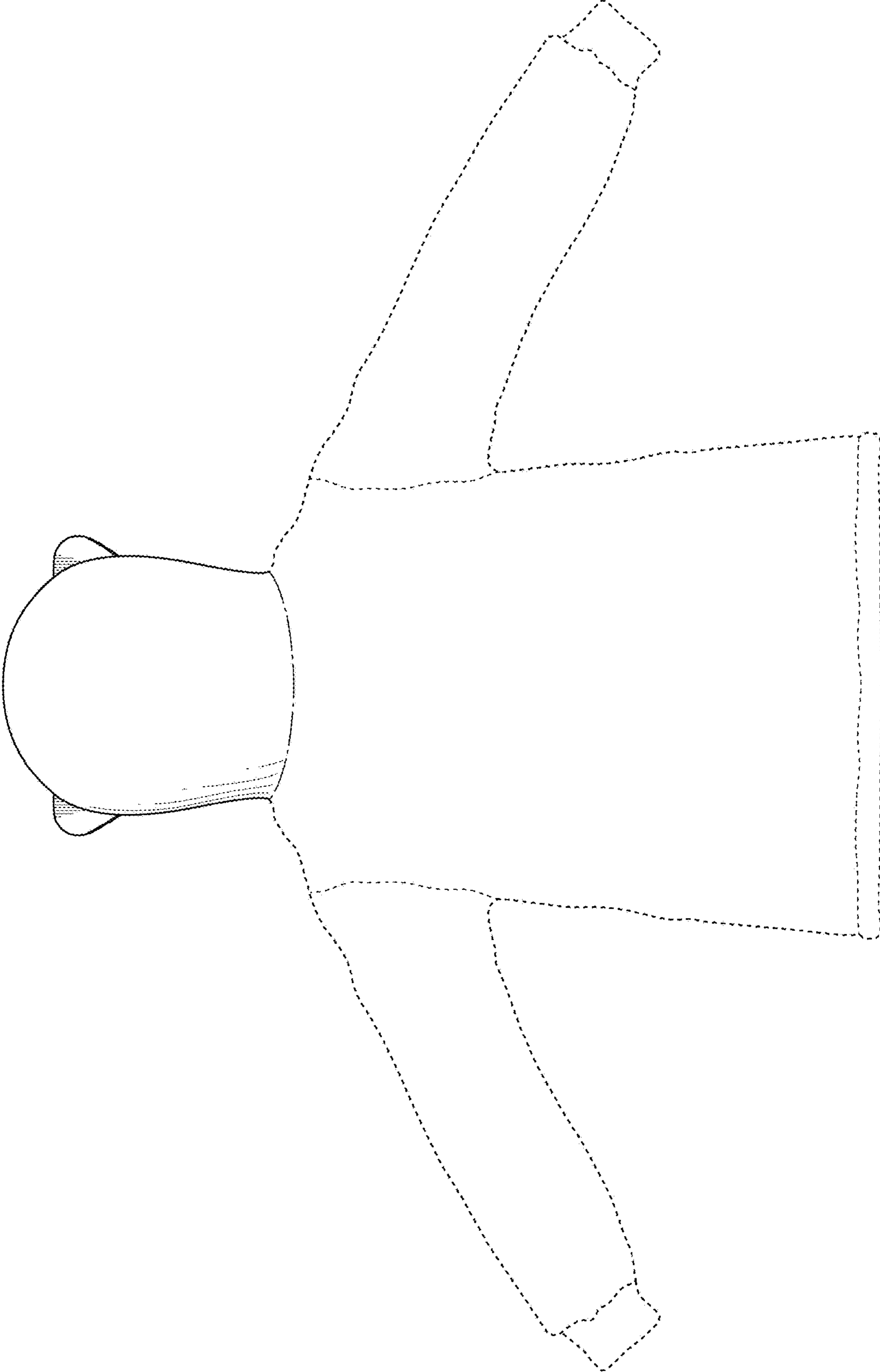

FIG. 3

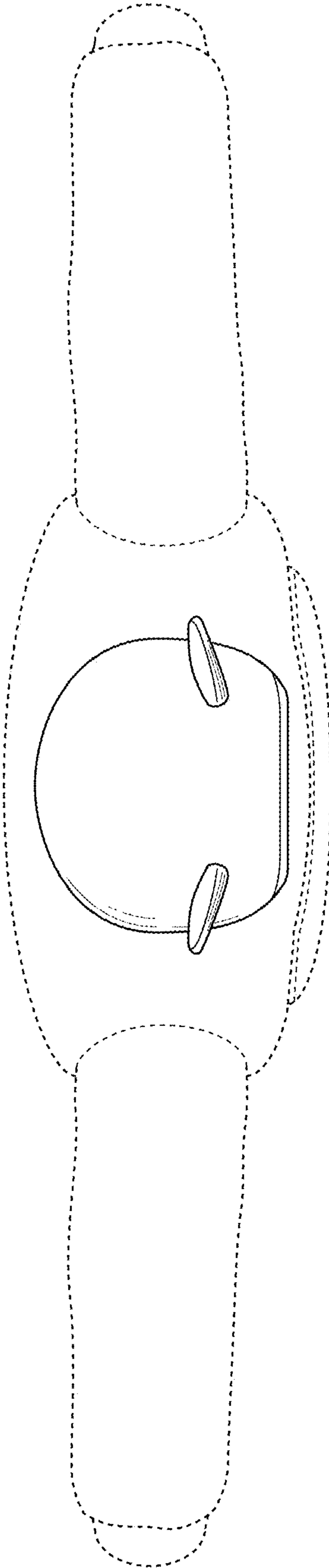

FIG. 4

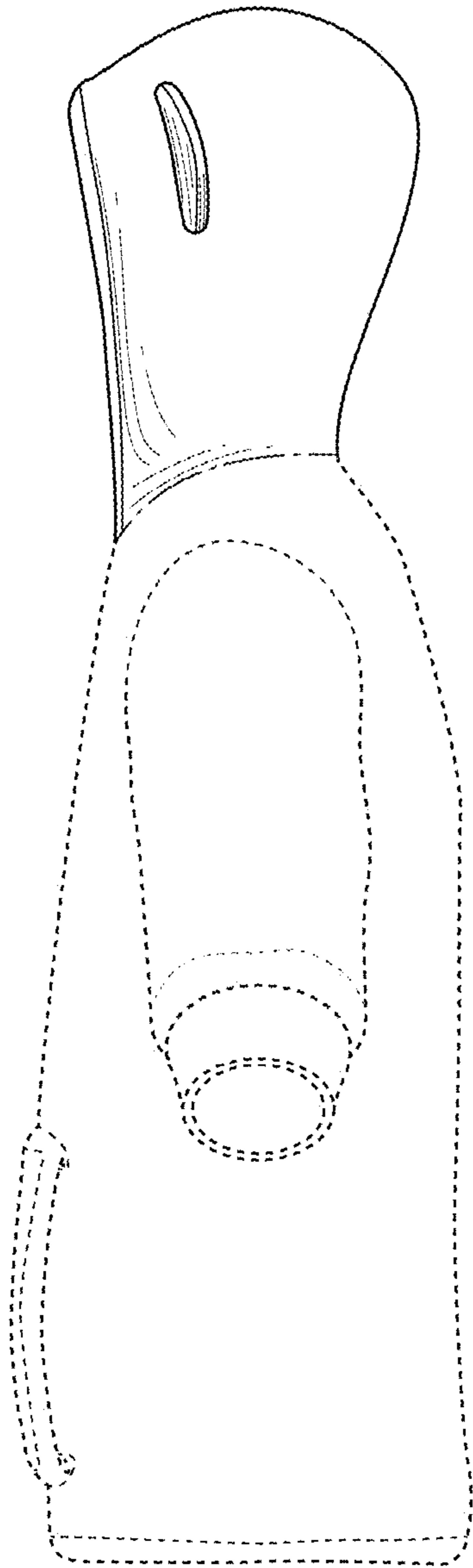

FIG. 5

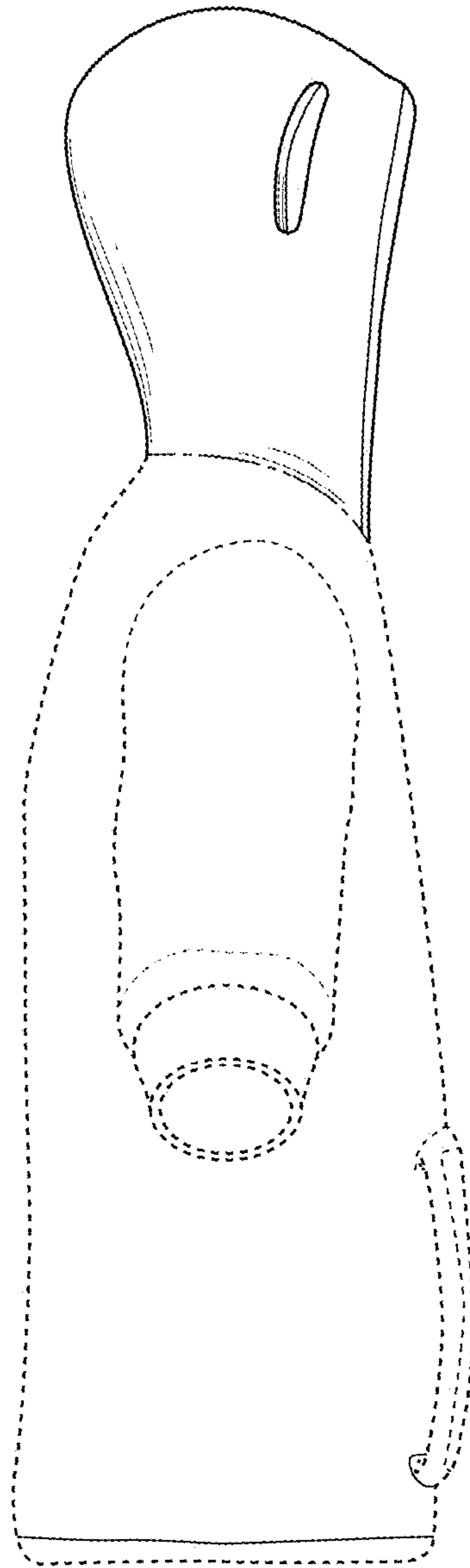

FIG. 6

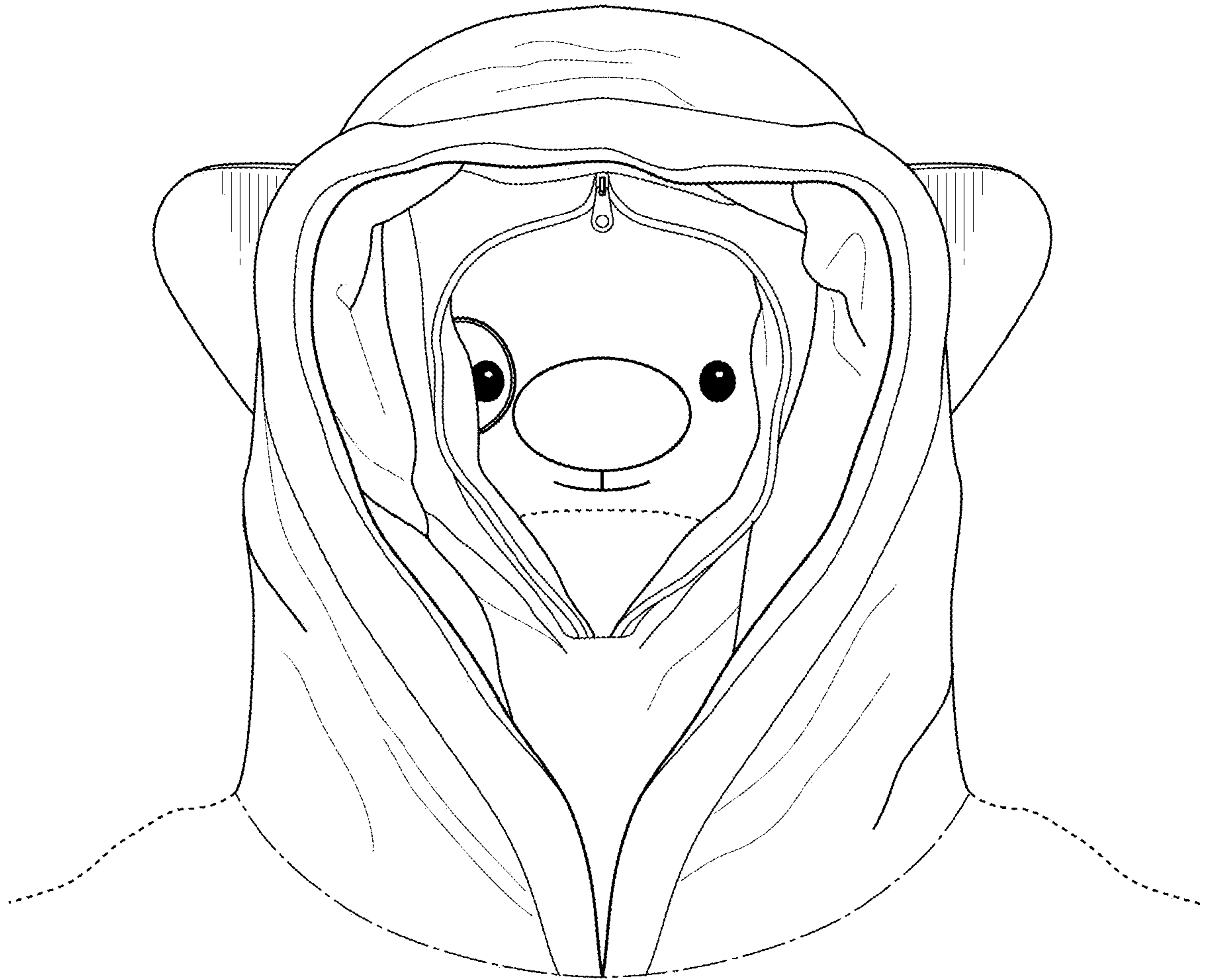

FIG. 7

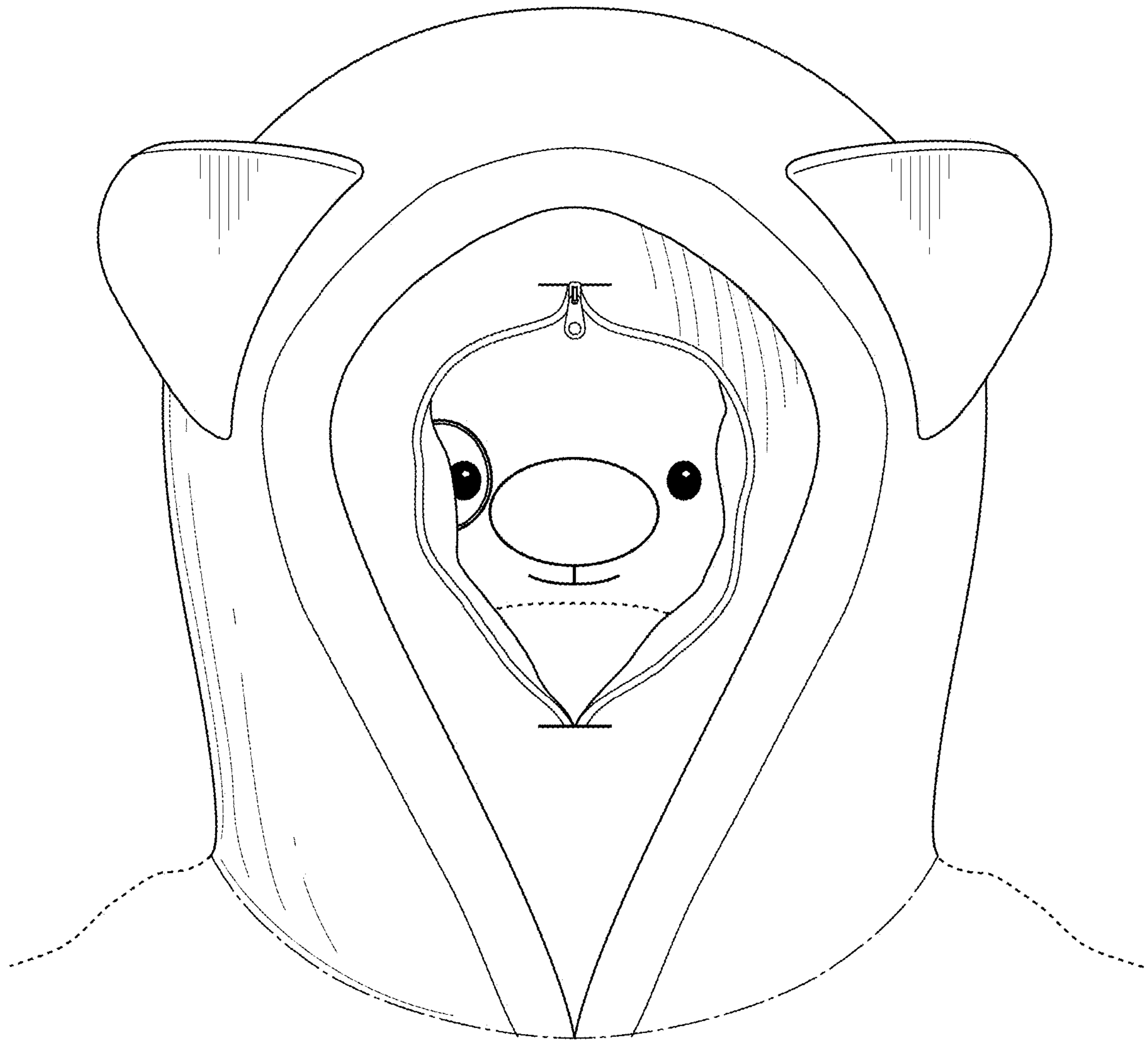

FIG. 8