



US00D881518S

(12) **United States Design Patent**
Buonocore

(10) **Patent No.:** **US D881,518 S**

(45) **Date of Patent:** **** Apr. 21, 2020**

(54) **SWEATSHIRT HOOD**

(71) Applicant: **Ontel Products Corporation**, Fairfield, NJ (US)

(72) Inventor: **Carly Buonocore**, Lincoln Park, NJ (US)

(73) Assignee: **ONTEL PRODUCTS CORPORATION**, Fairfield, NJ (US)

(**) Term: **15 Years**

(21) Appl. No.: **29/680,233**

(22) Filed: **Feb. 14, 2019**

(51) **LOC (12) Cl.** **02-02**

(52) **U.S. Cl.**
USPC **D2/831; D2/878**

(58) **Field of Classification Search**
USPC D2/728, 823, 824, 825, 826, 828, 831, D2/865, 866, 867, 870, 874, 877, 878, D2/880, 881, 887, 891, 892, 895; D5/13, D5/14, 20, 63, 64, 65; D6/598; D21/659, 660; D29/102, 108
CPC A41D 3/02; A41D 11/00; A41D 15/005; A41D 15/04; A41D 2200/20; A41D 27/08; A42B 1/00; A42B 1/006; A42B 1/04; A42B 1/041; A42B 1/045; A42B 1/046; A42B 1/048; A42B 7/00; A47G 9/1045; A63H 3/00

See application file for complete search history.

(56) **References Cited**

U.S. PATENT DOCUMENTS

2,103,608 A * 12/1937 Blauer A41D 3/00 2/84
4,543,669 A 10/1985 Katz
D285,815 S * 9/1986 Finn D2/741

D406,936 S * 3/1999 Sivret D2/865
D482,242 S * 11/2003 Yamane D2/831
D551,429 S * 9/2007 Wager D2/831
D672,534 S * 12/2012 Smith D2/878
D699,927 S * 2/2014 Fujioka D2/866
D708,822 S * 7/2014 Douglas D2/880
D713,126 S * 9/2014 Franz D2/825
D761,524 S * 7/2016 Cook D2/878
D802,886 S * 11/2017 Salce, Jr. D2/831
9,936,746 B1 4/2018 Park
2004/0181844 A1* 9/2004 Kim A41D 3/02 2/93

2008/0115254 A1 5/2008 Galkov
2014/0237700 A1 8/2014 Albert

(Continued)

Primary Examiner — Jasmine Mlinarcik

(74) *Attorney, Agent, or Firm* — Dickinson Wright PLLC

(57) **CLAIM**

I claim the ornamental design for a sweatshirt hood, as shown and described.

DESCRIPTION

FIG. 1 is a front perspective view of a sweatshirt hood; FIG. 2 is a front view of the sweatshirt hood of FIG. 1; FIG. 3 is a rear view of the sweatshirt hood of FIG. 1; FIG. 4 is a top view of the sweatshirt hood of FIG. 1; FIG. 5 is a right side view of the sweatshirt hood of FIG. 1; FIG. 6 is a left side view of the sweatshirt hood of FIG. 1; FIG. 7 is a front view of the sweatshirt hood of FIG. 1 in a laid-flat position with the zipper in an open position; and, FIG. 8 is a front view of the sweatshirt hood of FIG. 1 with the zipper in an open position.

The zipper follows the curvature of the sweatshirt hood. The dash-dot-dash broken line defines the bounds of the claim and forms no part of the claimed design. The even-length broken lines depict portions of the sweatshirt hood that form no part of the claimed design.

1 Claim, 7 Drawing Sheets

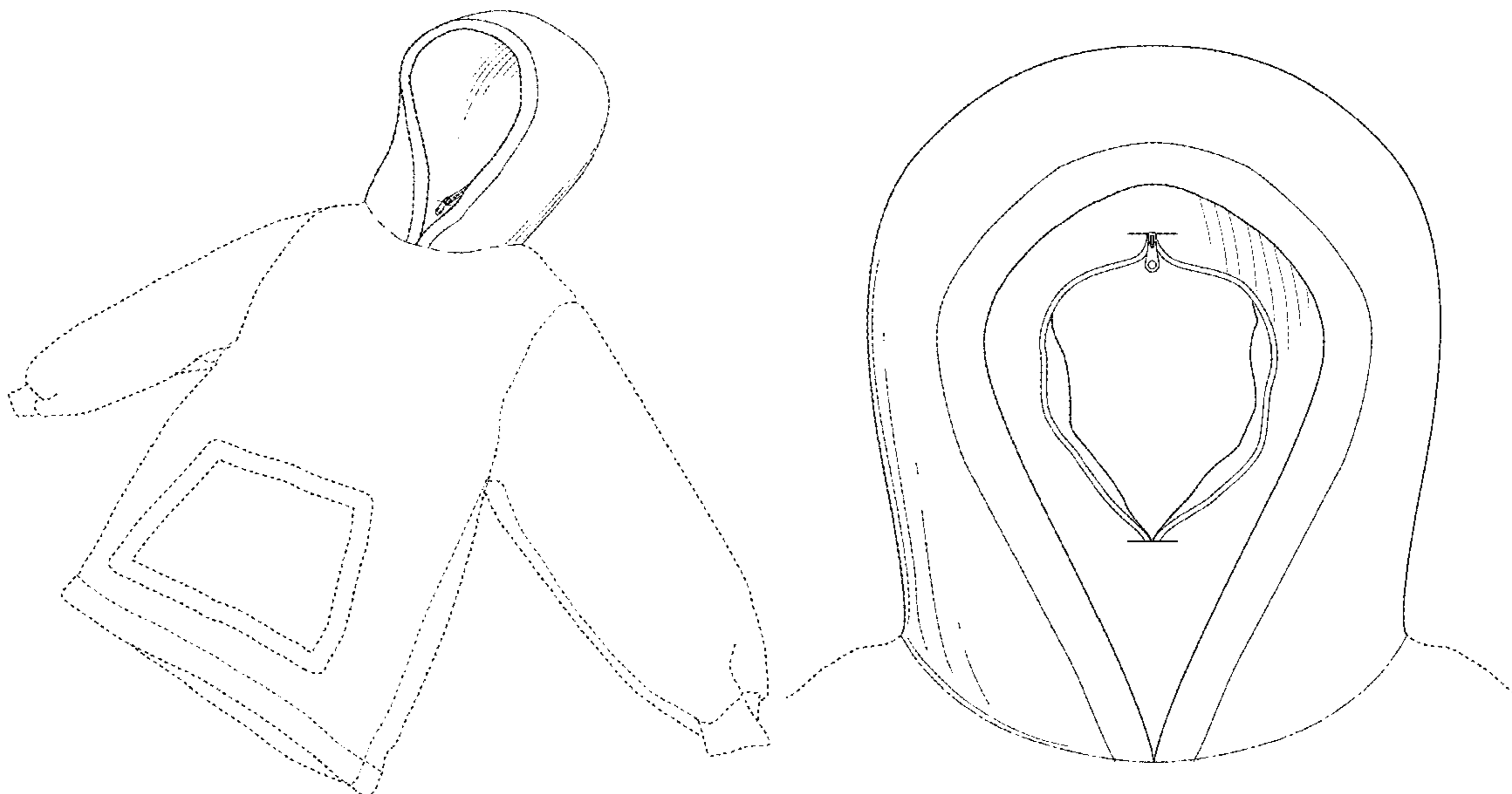

(56)

References Cited

U.S. PATENT DOCUMENTS

2015/0121604 A1 5/2015 Lee et al.
2018/0132551 A1 5/2018 Holder, III

* cited by examiner

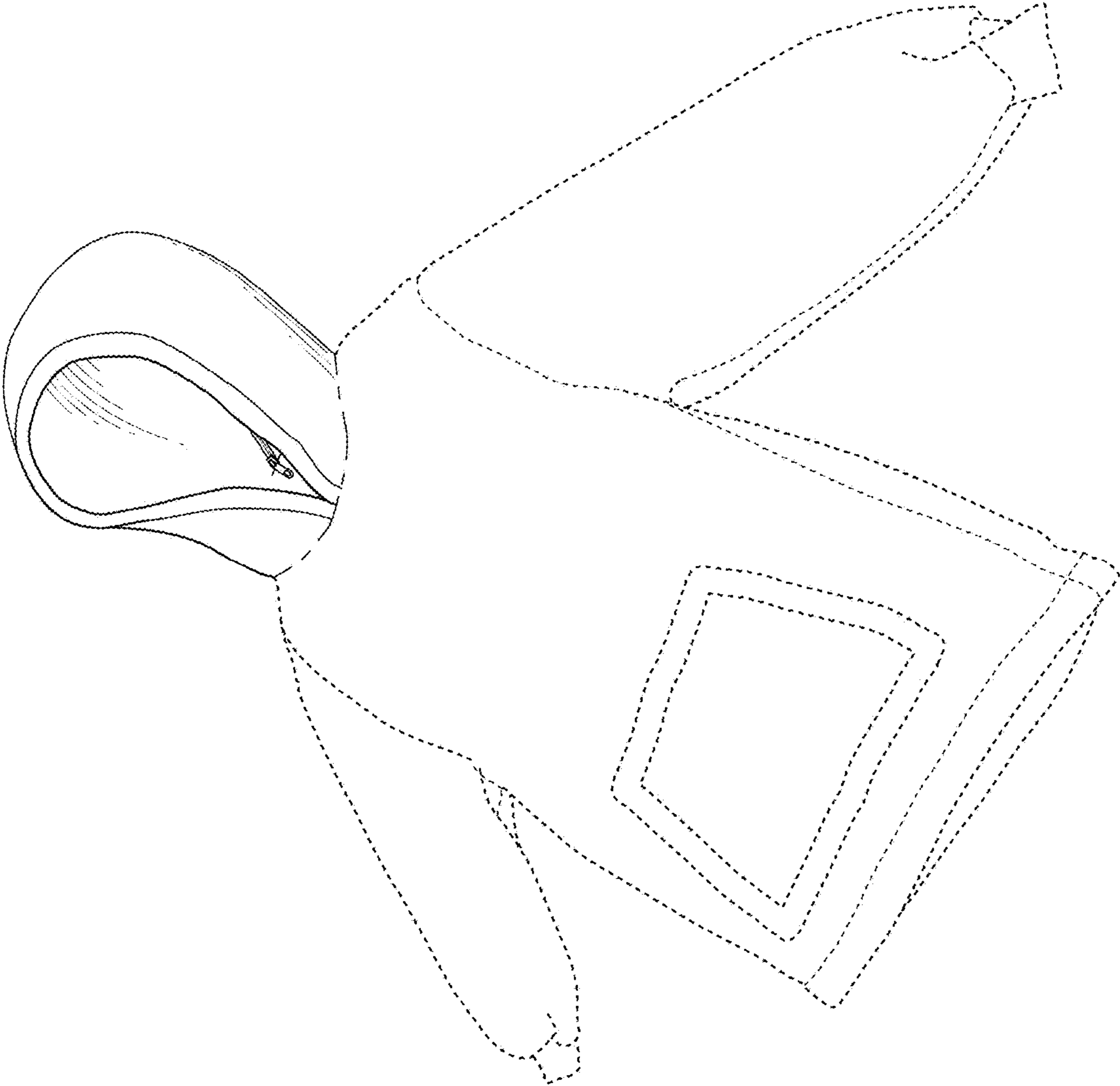

FIG. 1

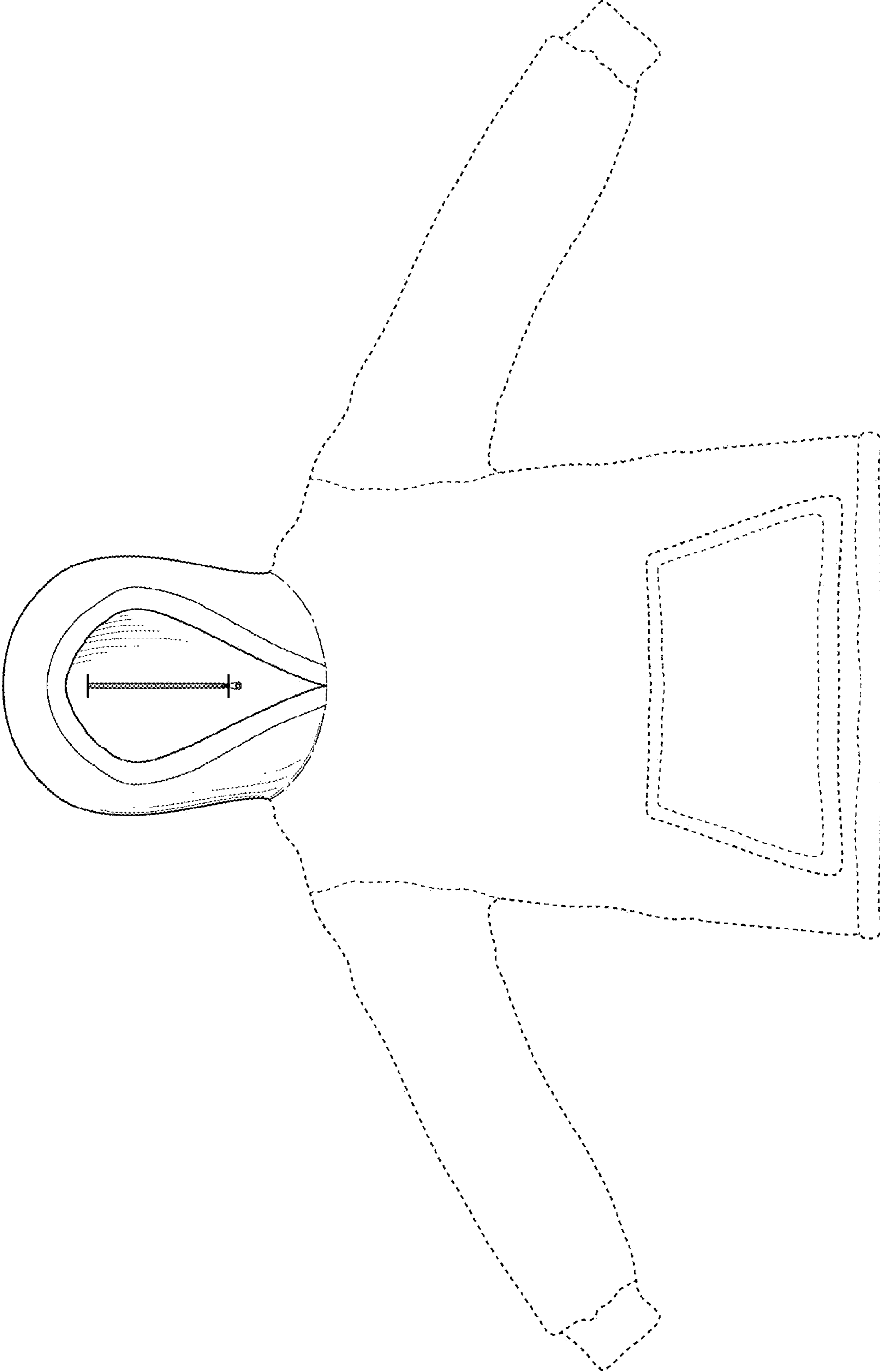

FIG. 2

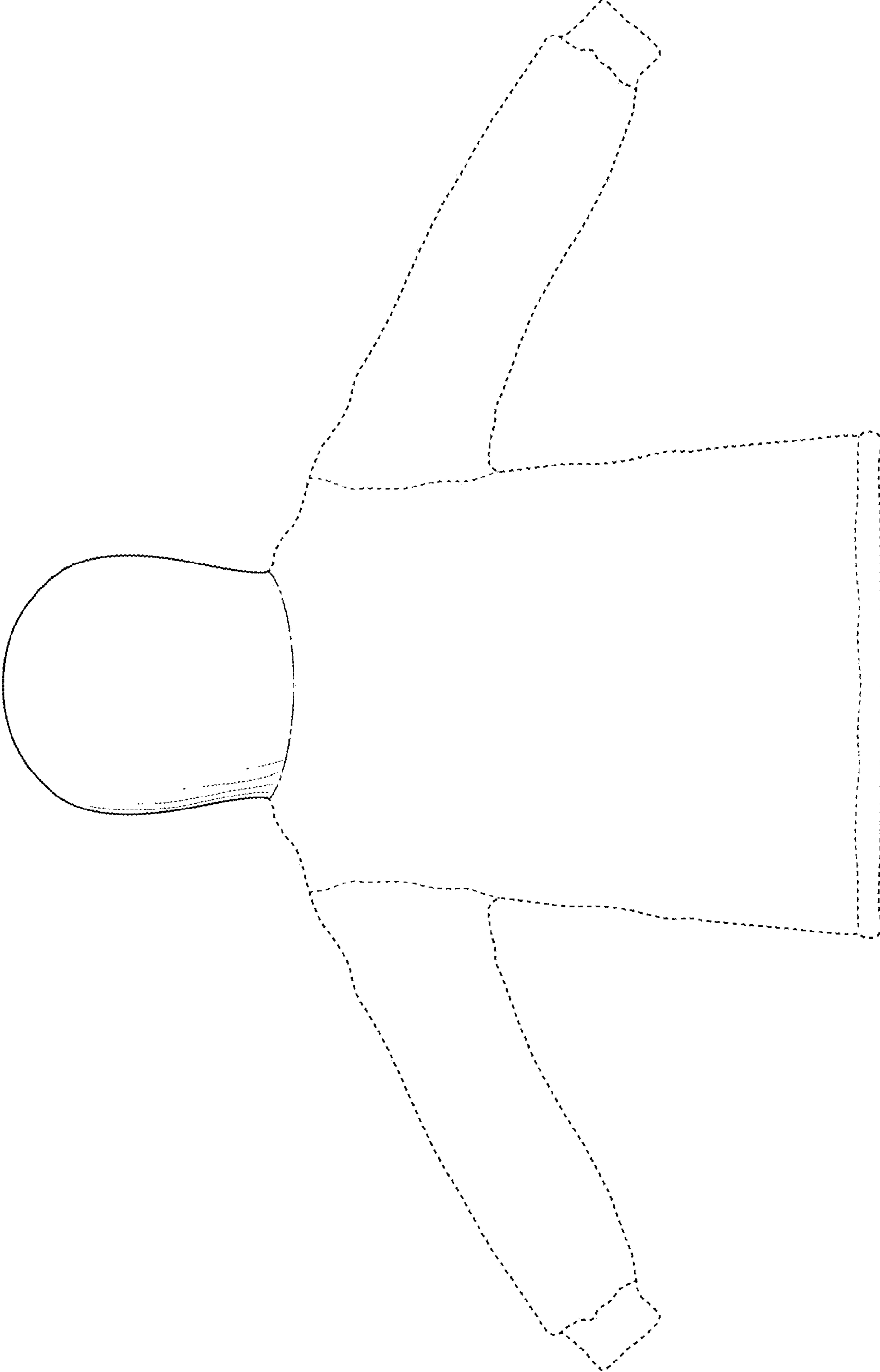

FIG. 3

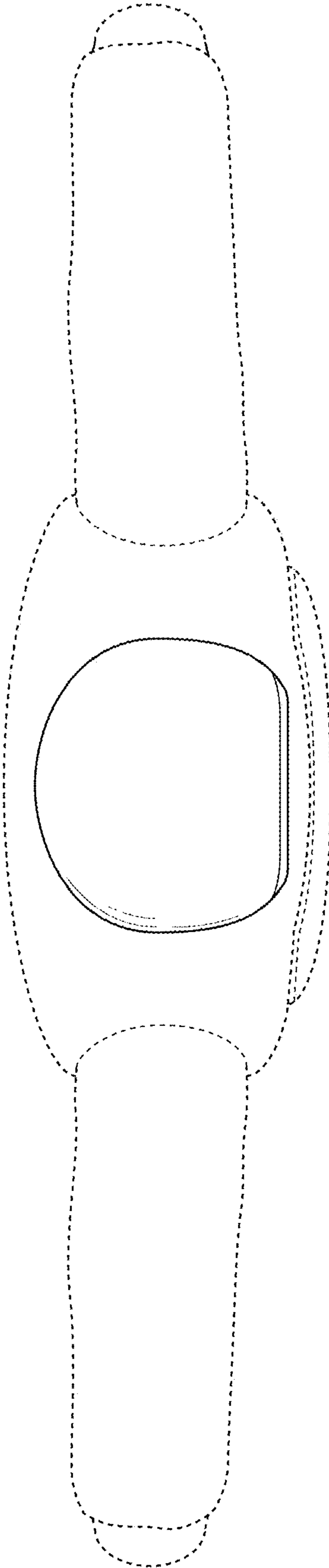

FIG. 4

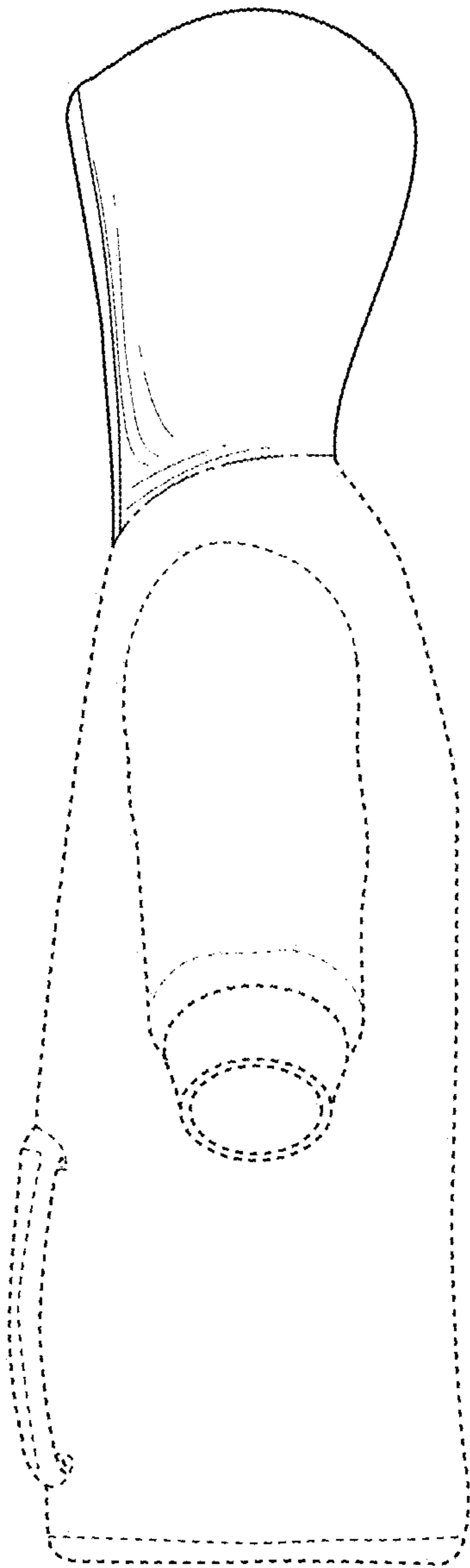

FIG. 5

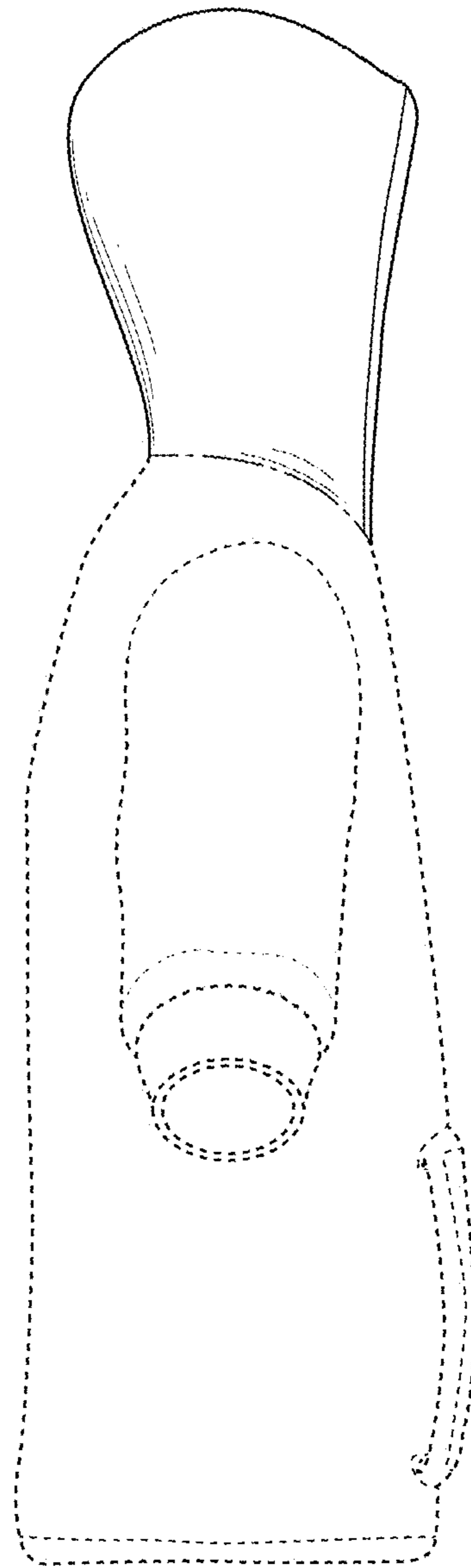

FIG. 6

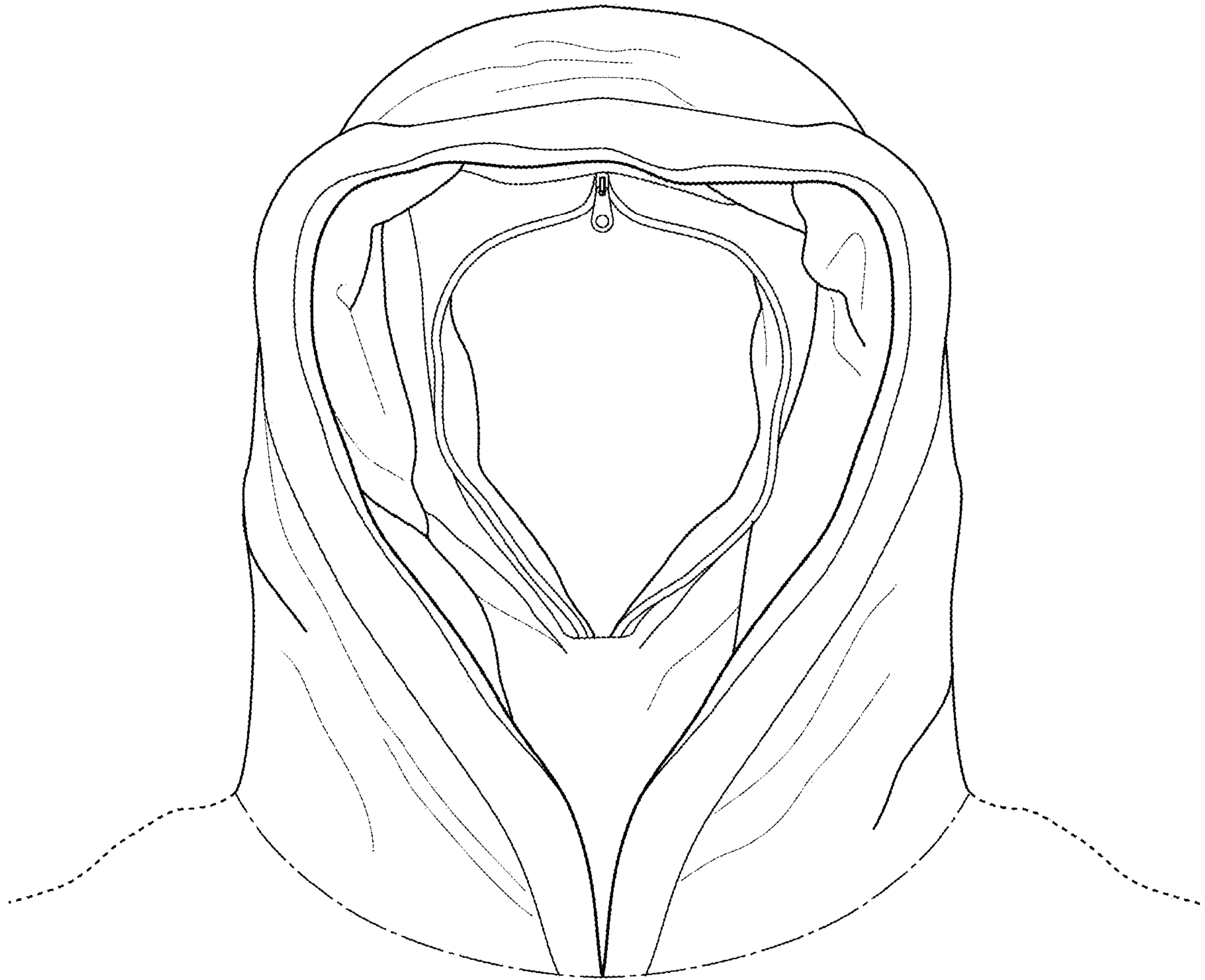

FIG. 7

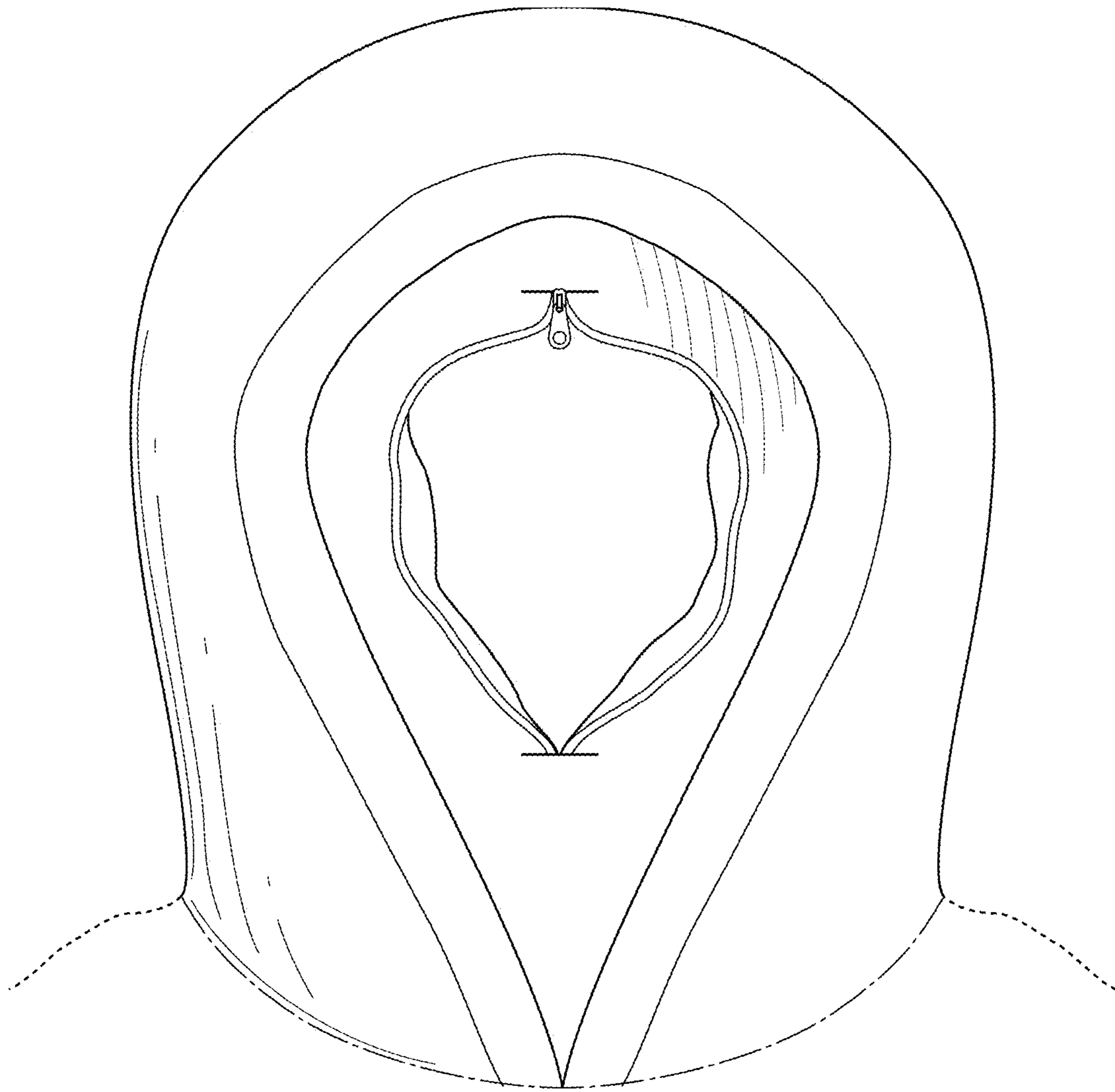

FIG. 8