



US00D881497S

(12) **United States Design Patent** (10) **Patent No.:** **US D881,497 S**  
**Libman et al.** (45) **Date of Patent:** **\*\* Apr. 14, 2020**

(54) **DUSTPAN**  
(71) Applicant: **The Libman Company**, Arcola, IL (US)  
(72) Inventors: **Aaron Libman**, Champaign, IL (US); **Carlos Aguiar**, Burgo (PT); **Roberto Pellacini**, Torrechiara Langhirano (IT)  
(73) Assignee: **The Libman Company**, Arcola, IL (US)  
(\*\*) Term: **15 Years**  
(21) Appl. No.: **29/618,846**  
(22) Filed: **Sep. 25, 2017**  
(51) **LOC (12) Cl.** ..... **07-05**  
(52) **U.S. Cl.**  
USPC ..... **D32/74**  
(58) **Field of Classification Search**  
USPC ..... D32/74, 41; D30/162; D7/691, 688; D4/116; 15/257.5, 257.3, 257.2, 257.1; 134/6  
CPC ..... A47L 13/52; A47L 13/51; A46B 15/00; A46B 15/0097; A46B 15/0095; A46B 17/04; A46B 5/00; A46B 2200/302  
See application file for complete search history.

D238,242 S 12/1975 Schwartzman  
3,981,106 A 9/1976 Gallo  
D274,383 S 6/1984 Banasiak  
D345,238 S 3/1994 Berti  
D347,915 S 6/1994 Berti  
D367,745 S 3/1996 Feldman et al.  
D394,928 S 6/1998 Laib  
D398,115 S 9/1998 Footer et al.  
D427,739 S \* 7/2000 Demore ..... D32/74  
6,266,839 B1 7/2001 Oretti et al.  
D463,643 S 9/2002 Petner  
D466,262 S \* 11/2002 Chemtob ..... D32/74  
D475,824 S 6/2003 Libman et al.  
D475,828 S \* 6/2003 Libman ..... D32/74  
D481,504 S 10/2003 Libman et al.  
D508,760 S \* 8/2005 Berti ..... D32/74  
D510,165 S \* 9/2005 Berti ..... D32/74

(Continued)

**FOREIGN PATENT DOCUMENTS**

FR 2198378 A7 3/1974  
GB 2187945 B 11/1989

*Primary Examiner* — Austin Murphy  
(74) *Attorney, Agent, or Firm* — Banner & Witcoff, Ltd.

(57) **CLAIM**

The ornamental design for a dustpan, as shown and described.

**DESCRIPTION**

FIG. 1 is a top, front, right perspective view of a dustpan showing our new design;  
FIG. 2 is a front view thereof;  
FIG. 3 is a rear view thereof;  
FIG. 4 is a right side view thereof;  
FIG. 5 is a left side view thereof; and,  
FIG. 6 is a top view thereof.  
The broken lines showing the remainder of the dustpan represent unclaimed subject matter and form no part of the claimed design.

**1 Claim, 4 Drawing Sheets**

(56) **References Cited**  
U.S. PATENT DOCUMENTS  
D190,499 S 5/1877 Lauback  
D59,131 S 9/1921 Scalise  
1,493,989 A 5/1924 Kielberg  
1,678,284 A 7/1928 Duhsel  
D91,098 S 11/1933 Badger  
D138,435 S 8/1944 Jaffa  
D166,226 S 3/1952 Roop  
2,817,106 A 12/1957 Putz  
D184,504 S 3/1959 Bliss  
D202,721 S 11/1965 Wenzlaff et al.

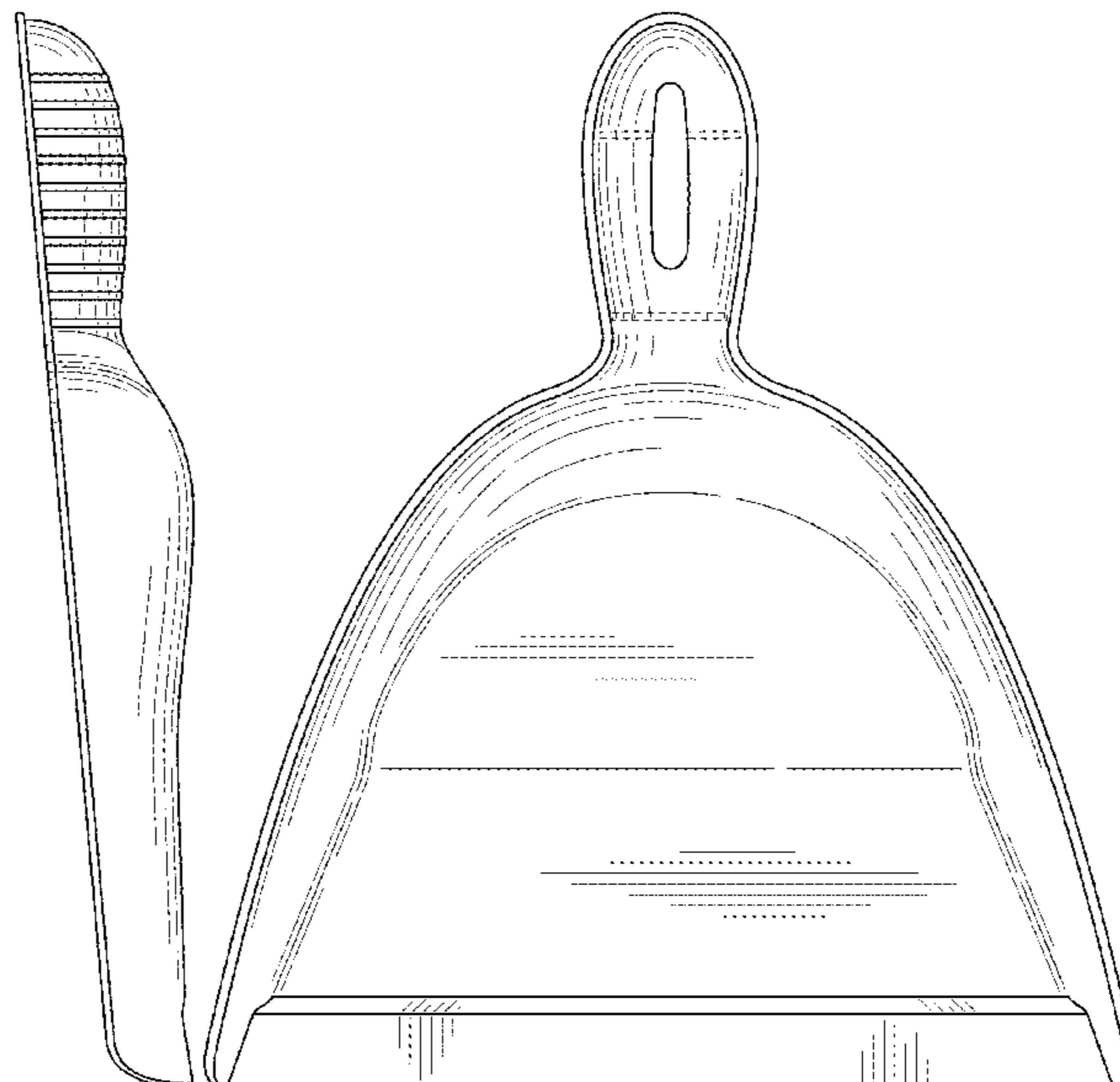

(56)

**References Cited**

U.S. PATENT DOCUMENTS

D525,004 S	7/2006	Berti	
D556,968 S	12/2007	Juergens	
D586,970 S *	2/2009	Berti .....	D32/74
D599,072 S *	8/2009	Meyer .....	D32/74
D630,401 S *	1/2011	Libman .....	D32/74
D667,191 S *	9/2012	Libman .....	D32/74
D667,192 S *	9/2012	Libman .....	D32/74
D687,204 S *	7/2013	Vasilakes .....	D32/74
D711,609 S *	8/2014	Libman .....	D32/74
D720,910 S *	1/2015	Seifts .....	D32/74
D721,463 S *	1/2015	Kandasamy .....	D32/74
D819,913 S *	6/2018	Beyda .....	D32/74
D835,371 S *	12/2018	Thompson .....	D32/74

\* cited by examiner

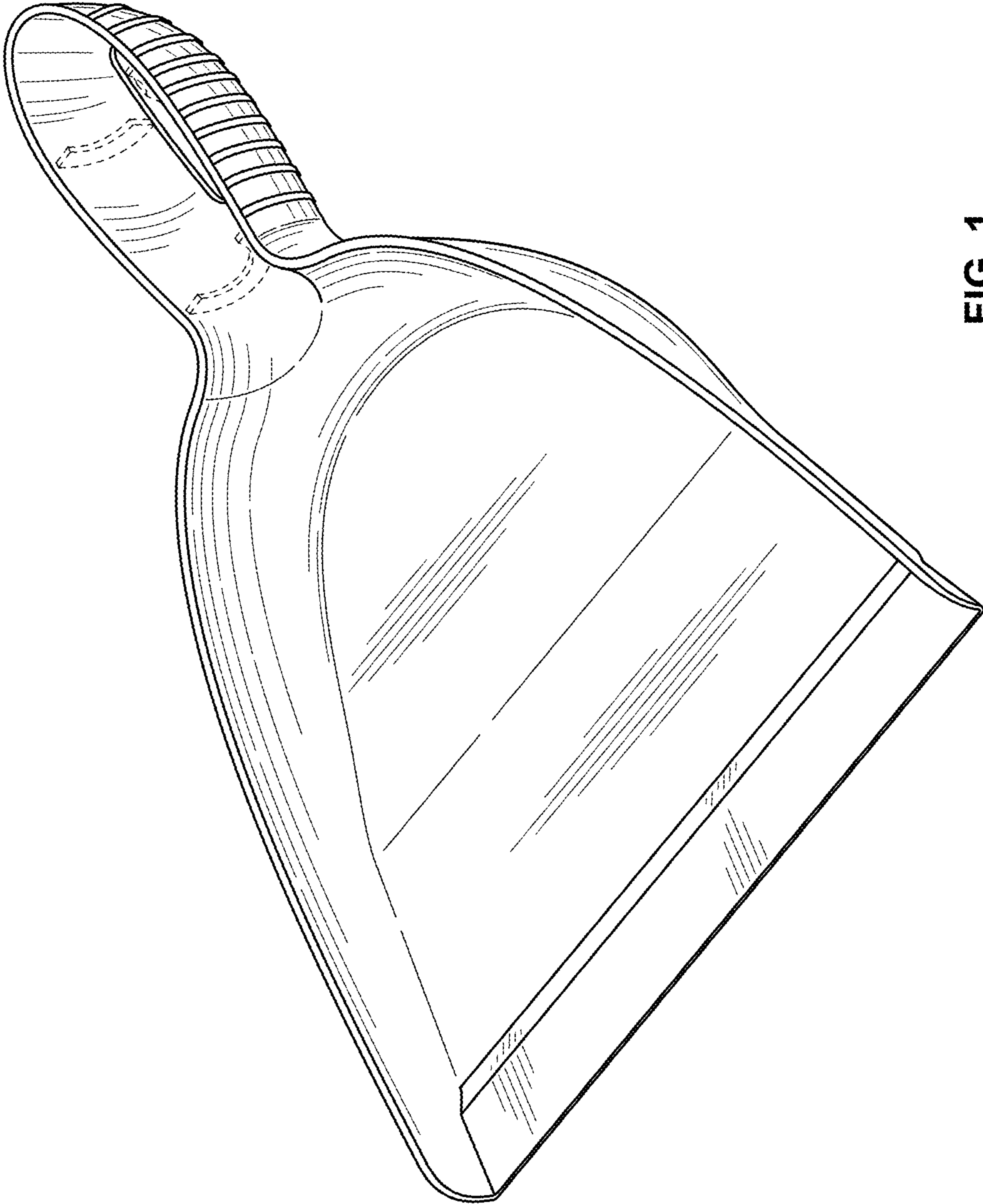

FIG. 1

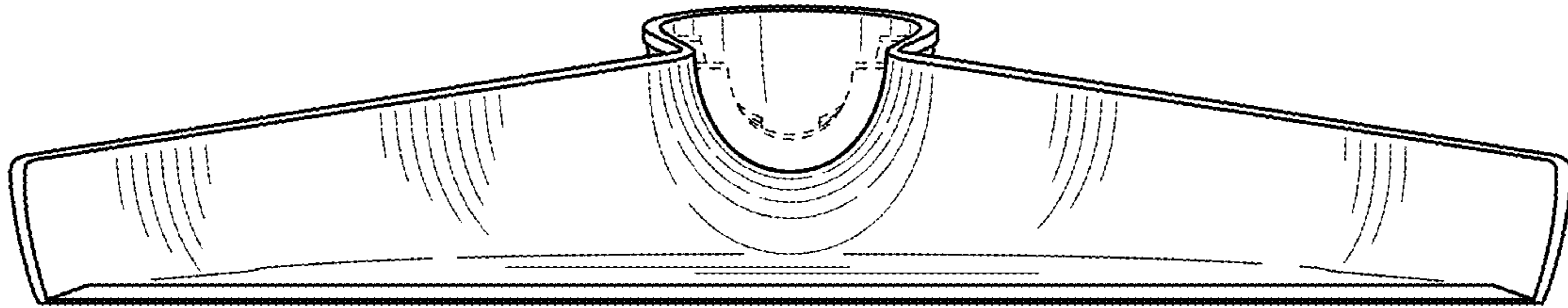

FIG. 2

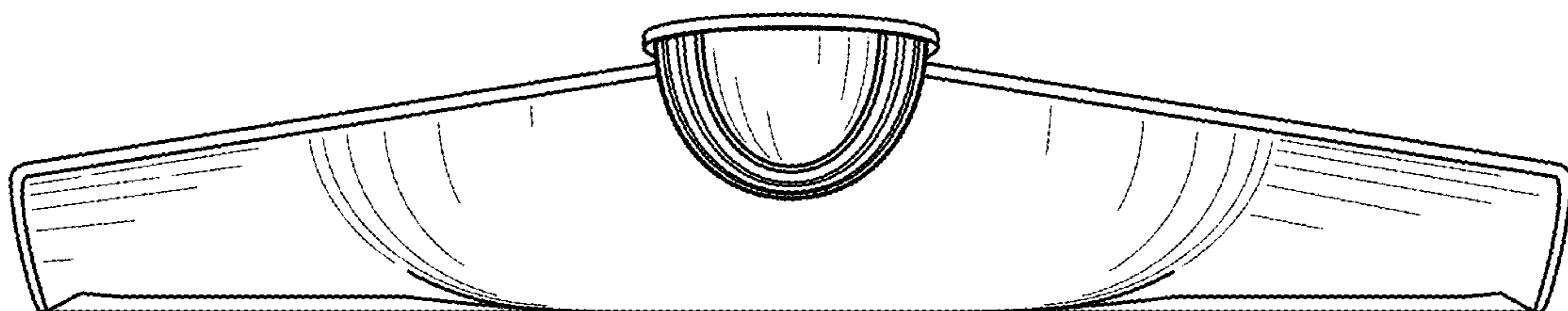

FIG. 3

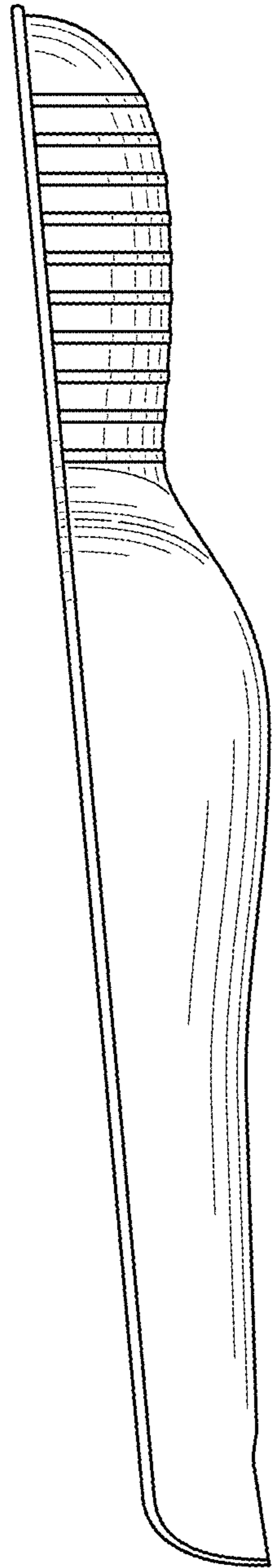

FIG. 4

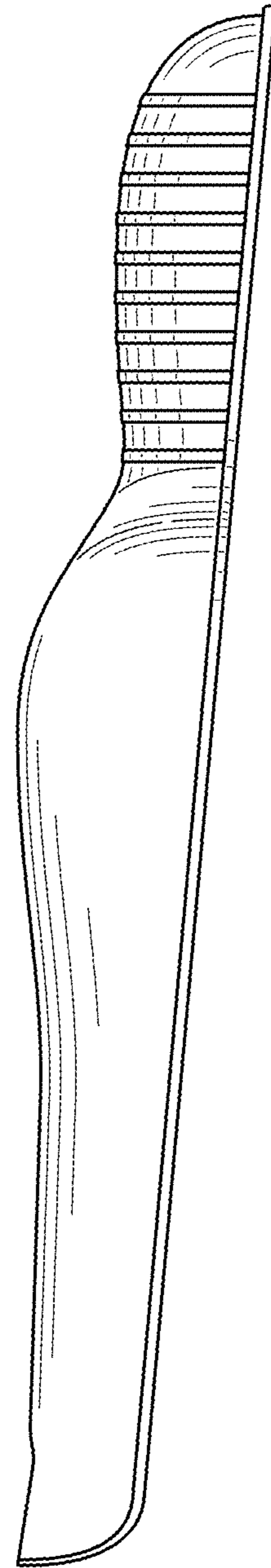

FIG. 5

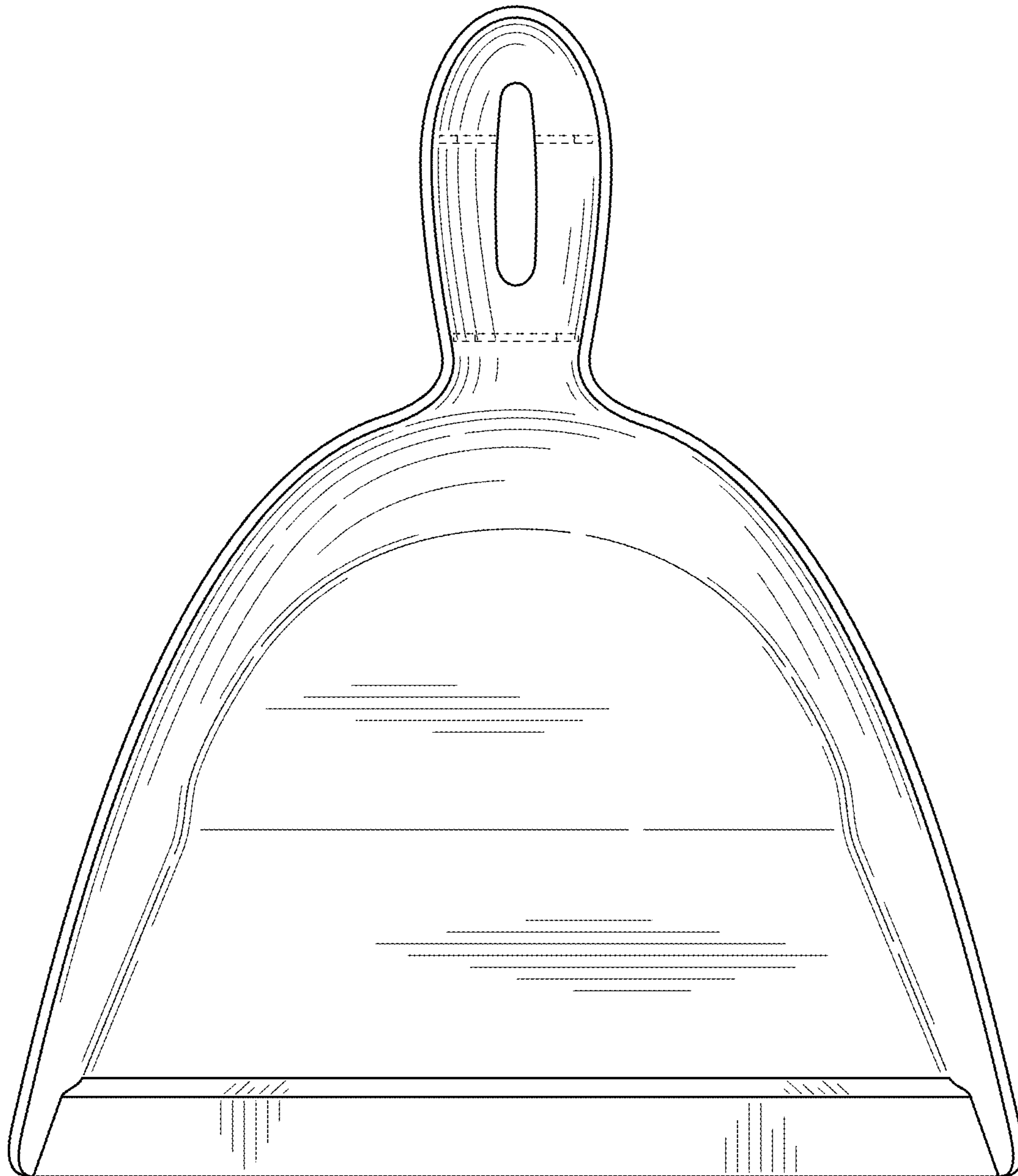

FIG. 6