



US00D881480S

(12) **United States Design Patent** (10) **Patent No.:** **US D881,480 S**
He (45) **Date of Patent:** **** Apr. 14, 2020**

(54) **CAT TOOTHBRUSH**

A63H 3/16; A63H 3/20; A63H 7/00;
A63H 13/00; A63H 11/18; A63H 11/20

(71) Applicant: **Guangzhou Jinyu Outdoor Products Co., Ltd.**, Guangzhou (CN)

See application file for complete search history.

(72) Inventor: **Zhenwang He**, Guangzhou (CN)

(56) **References Cited**

(**) Term: **15 Years**

U.S. PATENT DOCUMENTS

(21) Appl. No.: **29/716,067**

879,869	A *	2/1908	Hansen	A01K 85/00 43/42.13
1,109,439	A *	9/1914	Maus	A01K 85/18 43/42.15
1,792,366	A *	2/1931	Ettles	A01K 85/18 43/17.6
1,908,537	A *	5/1933	Pflueger	A01K 85/16 43/42.26

(22) Filed: **Dec. 6, 2019**

(51) **LOC (12) Cl.** **30-99**

(52) **U.S. Cl.**

USPC **D30/158**; D30/160; D30/199

(Continued)

(58) **Field of Classification Search**

USPC D30/158, 199, 160; D4/104, 105, 108,
D4/120, 119, 127, 128, 199, 132-134;
D24/194, 214, 215; 15/167.1, 167.2,
15/104.2, 22.1, 106, 110, 23, 71, 143.1,
15/207.2, 160-164; 119/707, 710, 174;
433/1, 229; 134/6; 601/139-142;
606/234, 235; D21/597, 599, 598, 483,
D21/576, 578, 579, 584, 585, 615, 398;
D11/158; 446/97, 356, 369, 376;
D22/125-133; 43/42, 42.15,
43/42.22-42.25, 42.28, 42.35

CPC A01K 13/00; A01K 13/001; A01K 13/004;
A01K 15/026; A01K 15/025; A01K
85/00; A01K 85/005; A01K 85/01; A01K
85/02; A01K 85/10; A01K 85/12; A01K
85/16; A01K 85/18; A61D 5/00; A46B
2200/1086; A46B 2200/1093; A46B
2200/405; A46B 2200/30; A46B
2200/306; A46B 2200/3073; A46B
2200/3086; A46B 2200/40; A46B 5/0075;
A46B 5/02; A46B 5/023; A46B 5/026;
A46B 9/045; A46B 9/08; A46B 9/10;
A46B 9/12; A46B 9/026; A47L 23/22;
A61B 5/682; A61J 17/02; A61J 17/001;
A61H 13/00; A63H 3/00; A63H 3/02;
A63H 3/06; A63H 3/08; A63H 3/10;

OTHER PUBLICATIONS

Interactive Cat Toothbrush, <https://www.amazinglycat.com/products/interactive-cat-toothbrush> Dec. 2019.

(Continued)

Primary Examiner — Susan Moon Lee

(74) *Attorney, Agent, or Firm* — KA Filing LLC; Wayne V. Harper

(57) **CLAIM**

I claim the ornamental design for a cat toothbrush, as shown and described.

DESCRIPTION

FIG. 1 is a Perspective view of a cat toothbrush showing my new design;

FIG. 2 is a Front view thereof;

FIG. 3 is a Back view thereof;

FIG. 4 is a Left-side view thereof;

FIG. 5 is a Right-side view thereof;

FIG. 6 is a Top view thereof; and,

FIG. 7 is a Bottom view thereof.

1 Claim, 7 Drawing Sheets

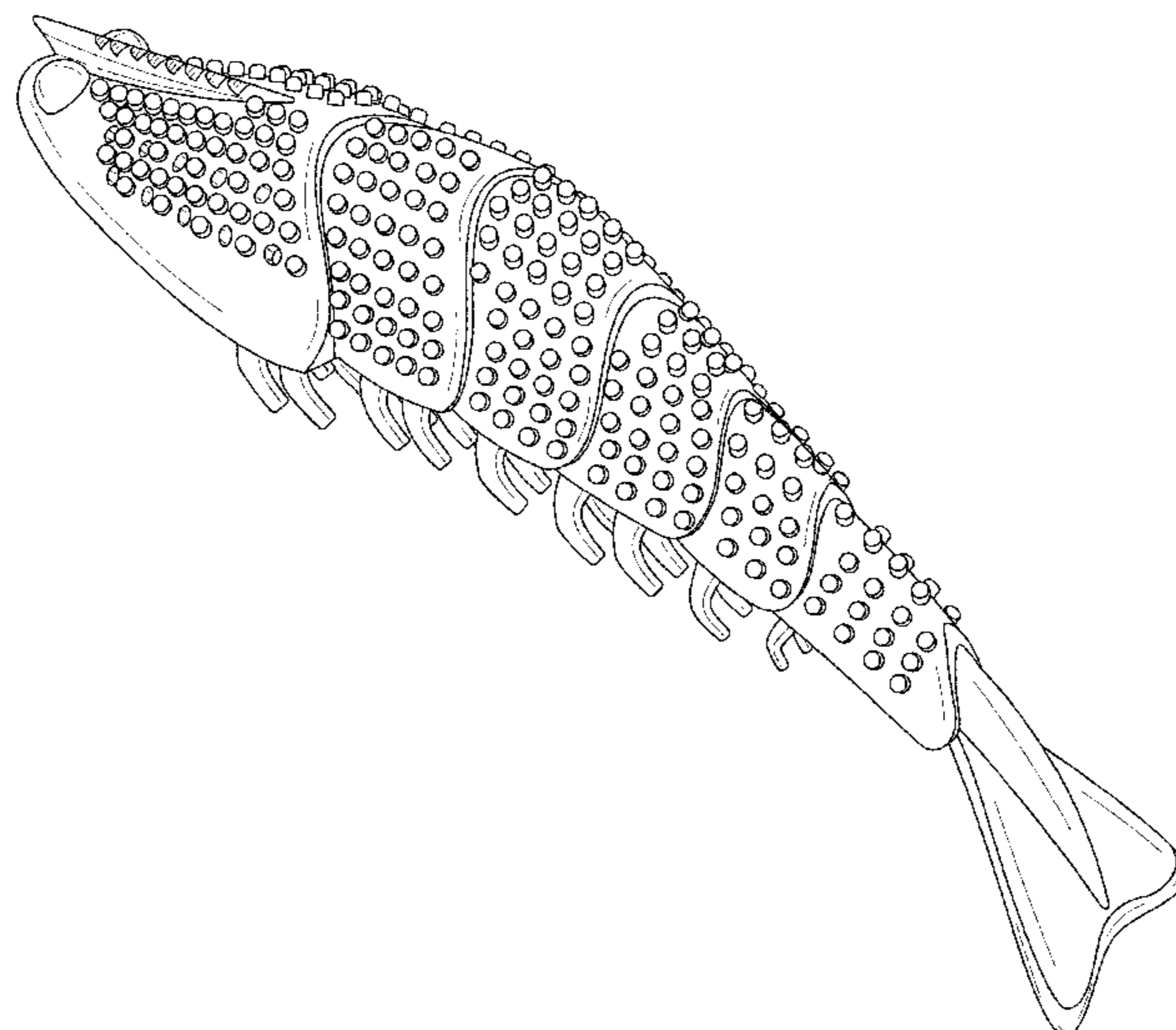

(56)

References Cited

U.S. PATENT DOCUMENTS

2012/0279459 A1* 11/2012 Angle A01K 15/025
119/707
2013/0266905 A1* 10/2013 Smith A61C 19/04
433/1
2013/0291804 A1* 11/2013 Lipscomb A01K 15/024
119/711
2014/0230752 A1* 8/2014 Yerton A01K 15/026
119/709
2015/0208625 A1* 7/2015 Mann A01K 85/01
43/17.6
2015/0289491 A1* 10/2015 Mancini A01K 85/00
43/17.6
2015/0373957 A1* 12/2015 Smith, Sr. A01K 85/01
43/42.06
2017/0071177 A1* 3/2017 Mann H02J 7/0045
2018/0077903 A1* 3/2018 Koskey A01K 15/025
2018/0132461 A1* 5/2018 Caldeira A01K 91/06
2019/0124888 A1* 5/2019 Coyle A61N 5/062
2020/0008398 A1* 1/2020 Willinger A01K 15/026

OTHER PUBLICATIONS

Wisdom Dog Toothbrush Stick-Puppy Dental Care Brushing Stick
Effective Doggy Teeth Cleaning Massager Natural Rubber Bite
Resistant Chew Toys for Dogs Pets, https://www.amazon.com/dp/B07JKSV17D/ref=sspa_dk_detail_1?psc=1&spLa=ZW5jcnIwdGVkUXVhbGlmaWVyPUEzVEY3VVo0VIJYSkplJmVuY3J5cHRIZEIkPUEwNTcxODI4MTk5Q1FQVEIXR0dGNyZiBmNyeXB0ZWRBZEIkPUEwMTI1NTYxMUdaOTdOVVFPNEtaUyZ3aWRnZXR0YW11PXNwX2RldGFpbDIyYWN0aW9uPWNsaWNrUmVkaXJlY3QmZG9Ob3RMb2dDbGljaz10cnVI Dec. 2019.
HETOO Cat Toys,Interactive Cat Toothbrush Catnip Chew Treat Toy for Kitten Kitty Cats Teeth Cleaning Dental Care, Crayfish Shape Pet Toy Cat, https://www.amazon.com/HETOO-Interactive-Toothbrush-Cleaning-Crayfish/dp/B07ZJJVTDS/ref=pd_sim_199_27?_encoding=UTF8&pd_rd_i=B07ZJJVTDS&pd_rd_r=10141b4d-d00f-40e2-84f8-e3d8f3b41d71&pd_rd_w=HexXN&pd_rd_wg=8Bh5b&pf_rd_p=04d27813-a1f2-4e7b-a32b-b5ab374ce3f9&pf_rd_r=7ZET342BNFZ2GJK14ZRF&psc=1&refRID=7ZET342BNFZ2GJK14ZRF Dec. 2019.

* cited by examiner

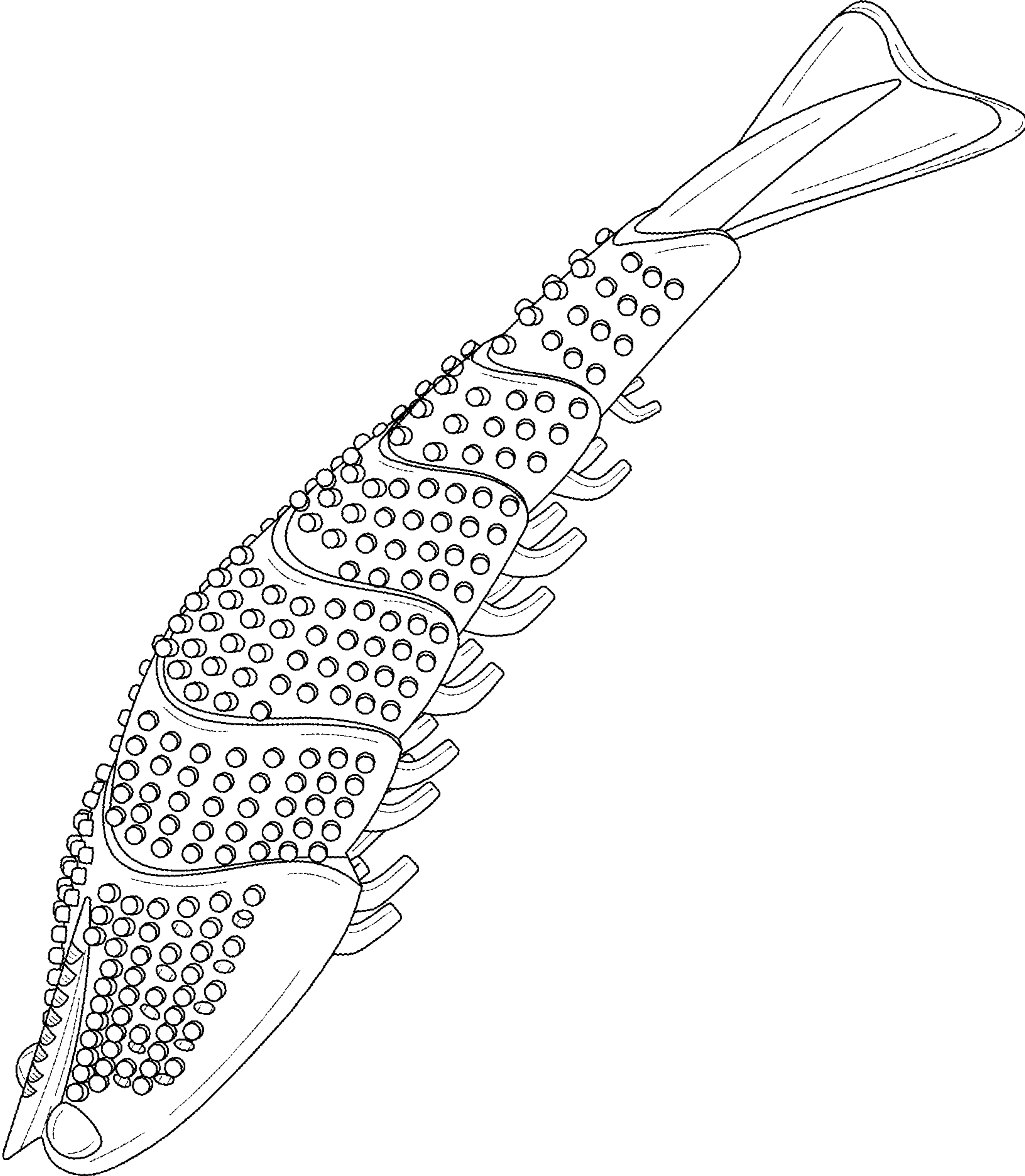

FIG. 1

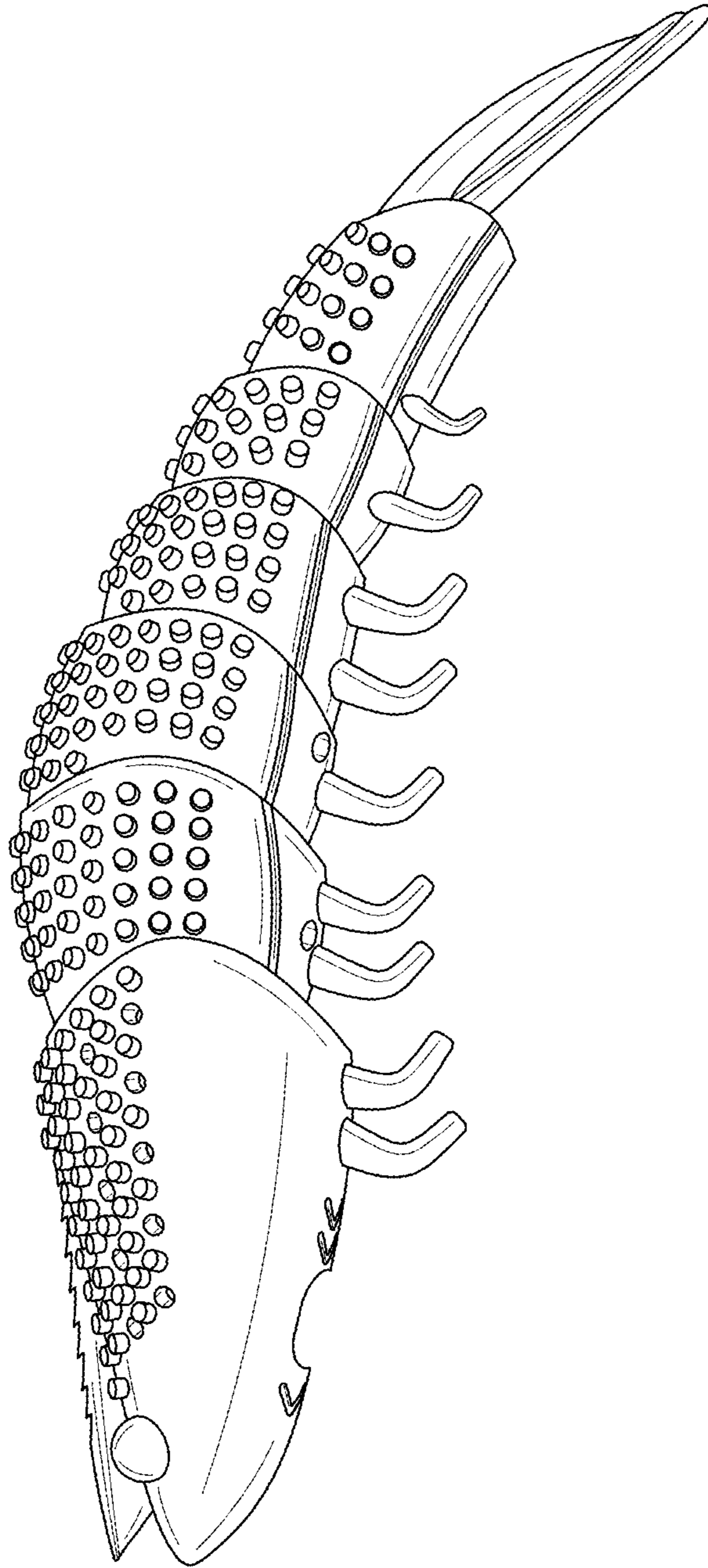

FIG. 2

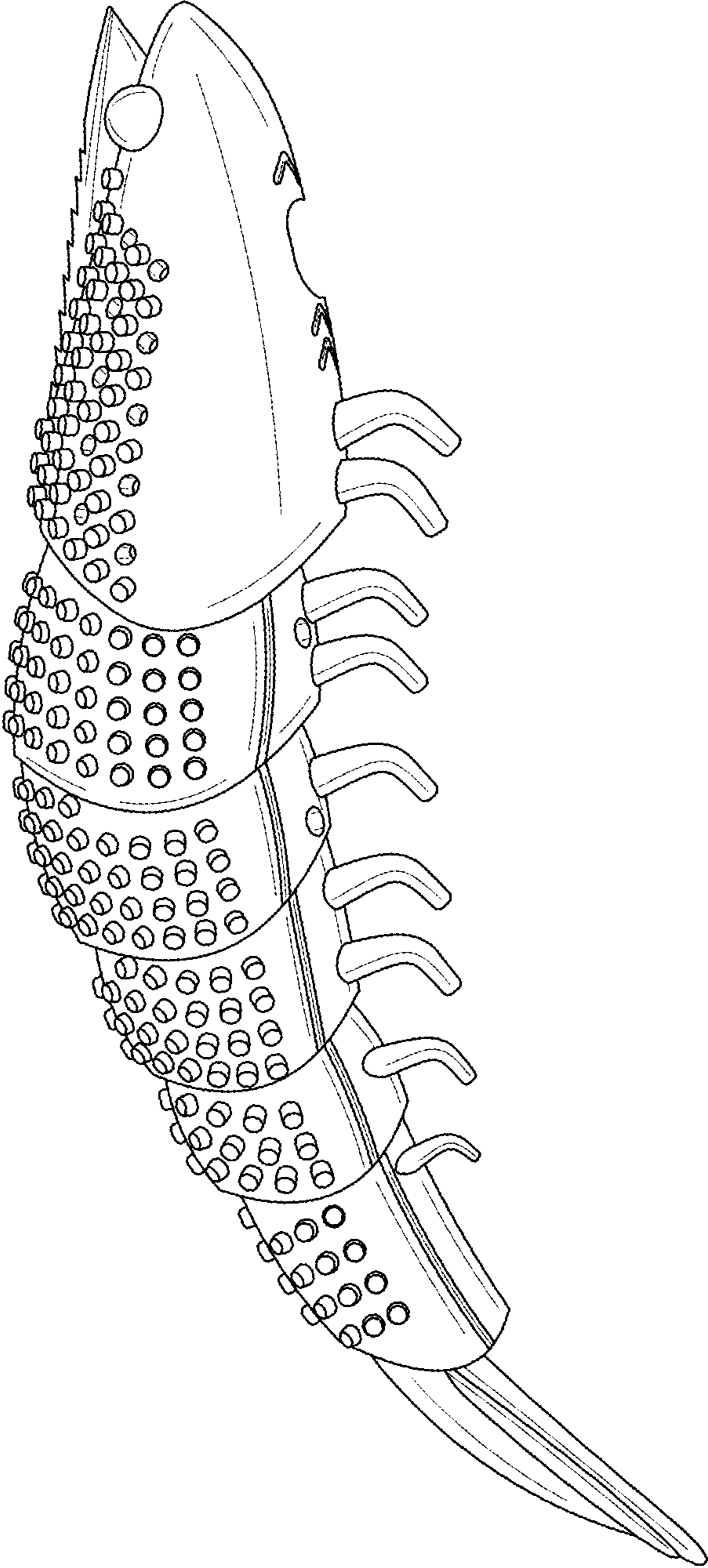

FIG. 3

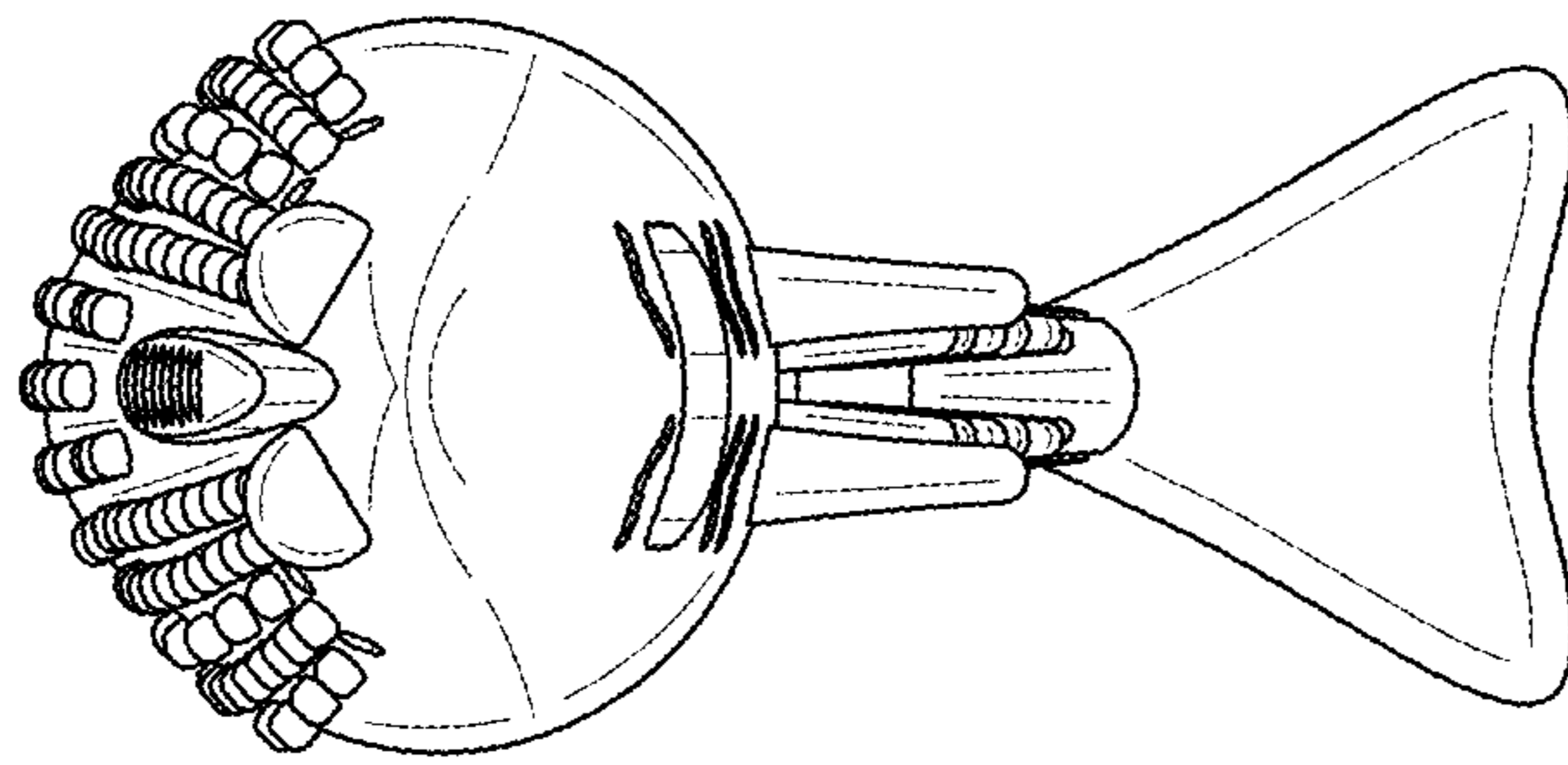

FIG. 4

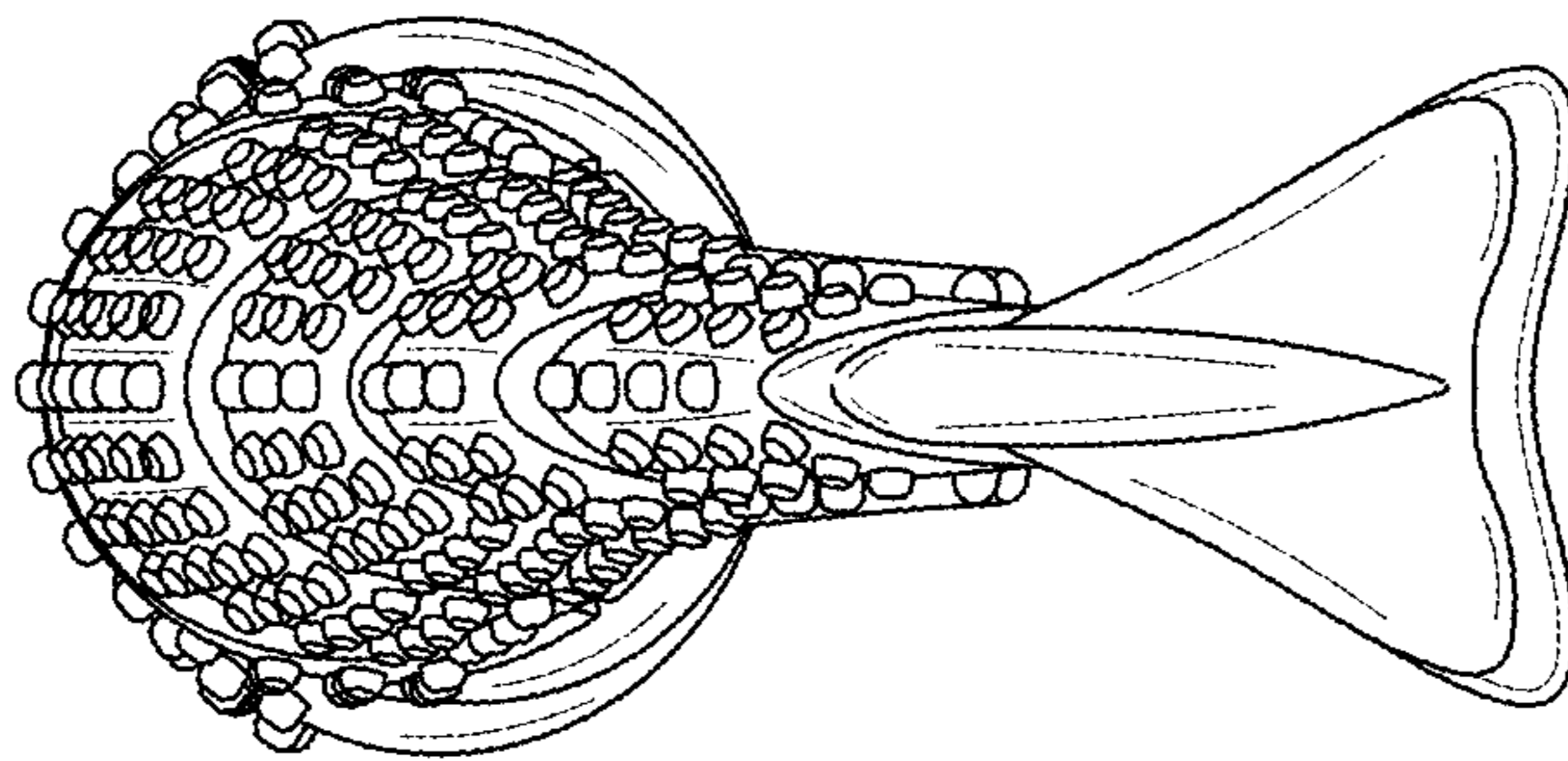

FIG. 5

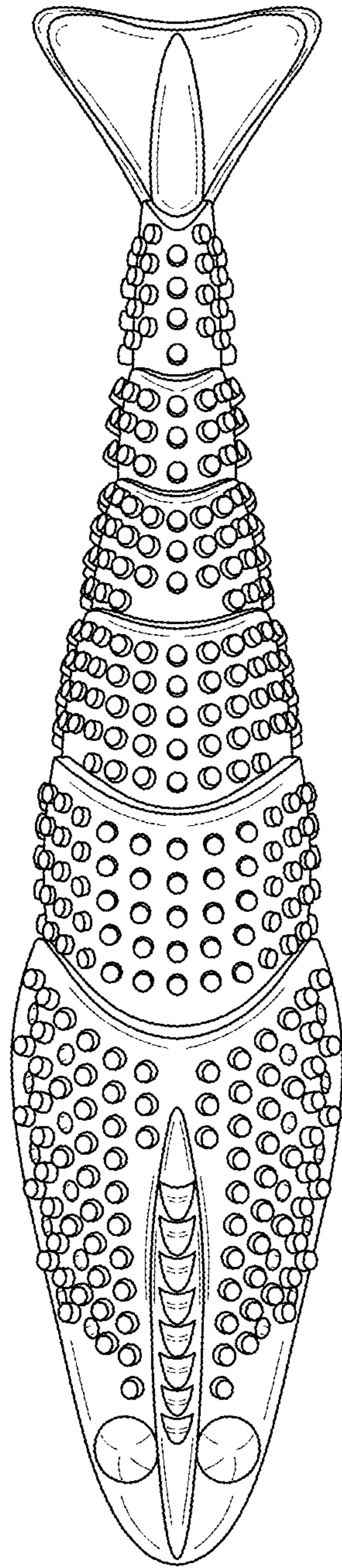

FIG. 6

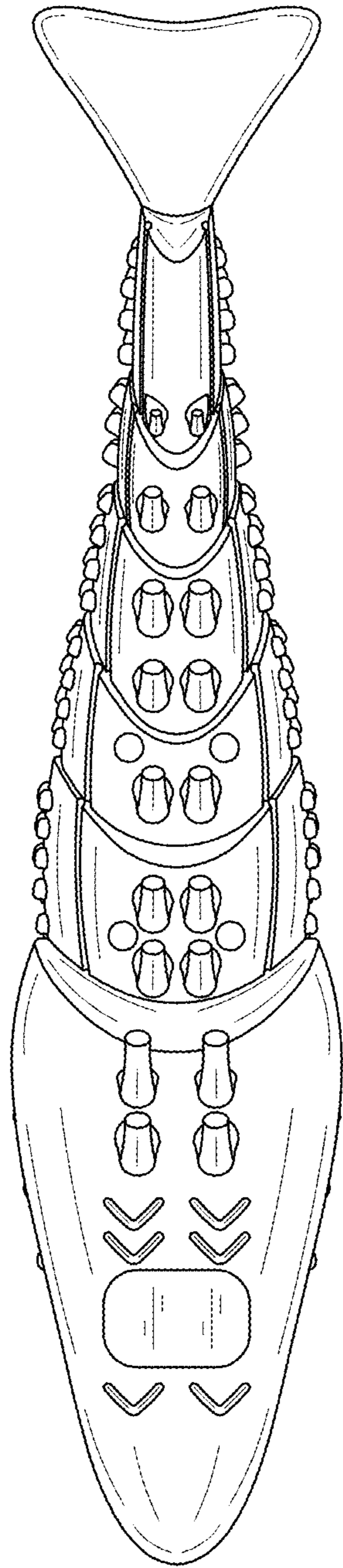

FIG. 7