



US00D881476S

(12) **United States Design Patent** (10) **Patent No.:** **US D881,476 S**
Koop (45) **Date of Patent:** **** Apr. 14, 2020**

(54) **CAR-TRANSPORTABLE CRADLE**

(56) **References Cited**

(71) Applicant: **Rosemary Koop**, Oregon City, OR (US)

U.S. PATENT DOCUMENTS

(72) Inventor: **Rosemary Koop**, Oregon City, OR (US)

D424,248 S *	5/2000	Sommers	D30/109
D451,646 S *	12/2001	Lerner	D30/109
8,539,909 B2 *	9/2013	Williams	A01K 1/0353
				119/28.5
2008/0156275 A1 *	7/2008	Lam	A01K 1/0245
				119/497

(**) Term: **15 Years**

* cited by examiner

(21) Appl. No.: **29/656,073**

Primary Examiner — Derrick E Holland

(22) Filed: **Jul. 10, 2018**

Related U.S. Application Data

(57) **CLAIM**

(63) Continuation-in-part of application No. 15/617,964, filed on Jun. 8, 2017, now Pat. No. 10,486,641.

The ornamental design for a car-transportable cradle, as shown and described.

(51) **LOC (12) Cl.** **30-02**

DESCRIPTION

(52) **U.S. Cl.**
USPC **D30/109**

FIG. 1 is a top perspective view of a car-transportable cradle;
 FIG. 2 is a bottom perspective view thereof;
 FIG. 3 is a front elevational view thereof;
 FIG. 4 is a rear elevational view thereof;
 FIG. 5 is a right side elevational view thereof;
 FIG. 6 is a left side elevational view thereof;
 FIG. 7 is a top plan view thereof; and,
 FIG. 8 is a bottom plan view thereof.

(58) **Field of Classification Search**

USPC D30/108, 109, 113, 119, 120; D24/183, D24/184; D12/220, 223, 416
 CPC A01K 1/0236; A01K 1/0254; A01K 1/029; A01K 1/05; A01K 1/0272; A01K 1/0353; A61G 13/102; A61G 13/121; A61G 15/16; B60R 22/10

See application file for complete search history.

1 Claim, 8 Drawing Sheets

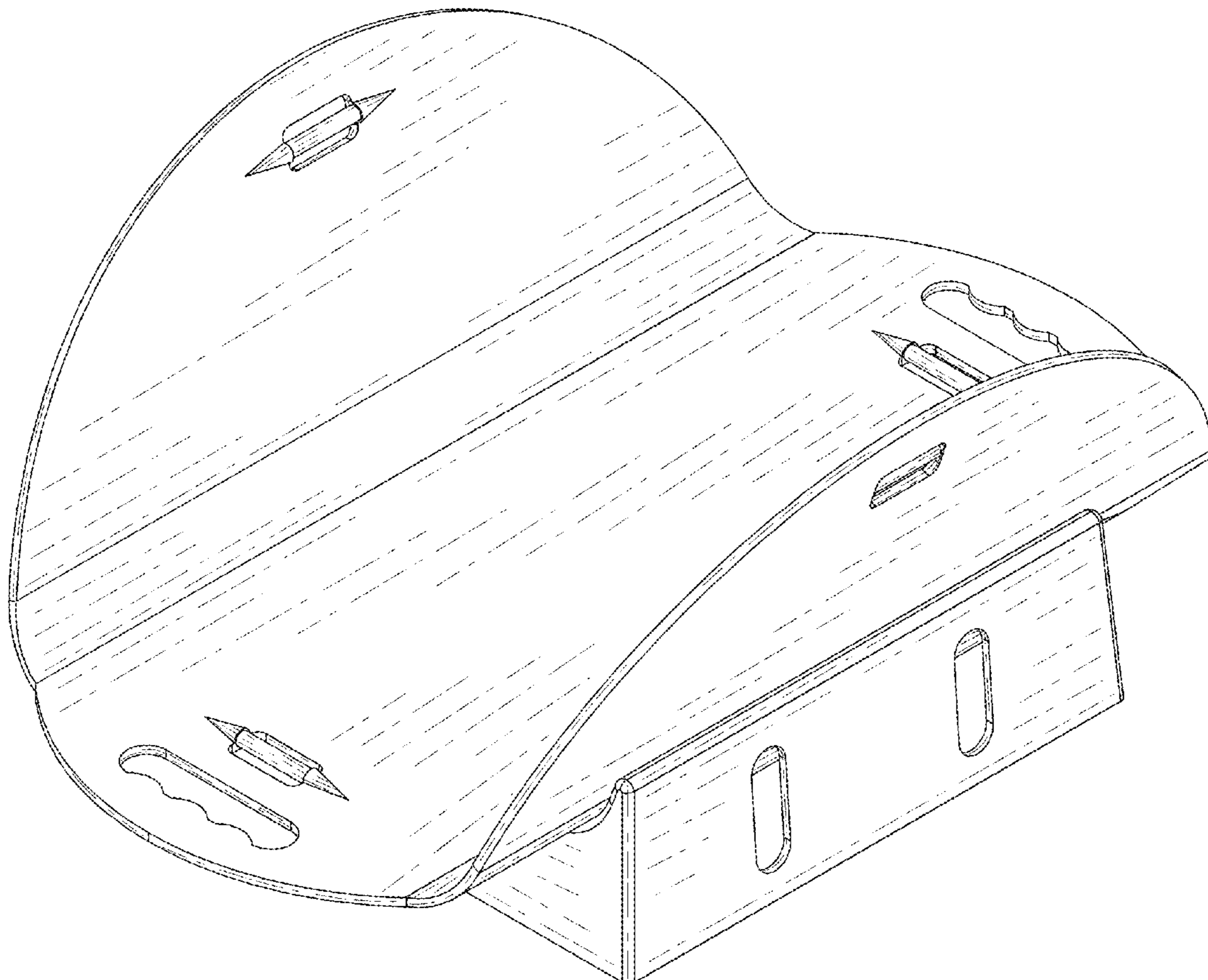

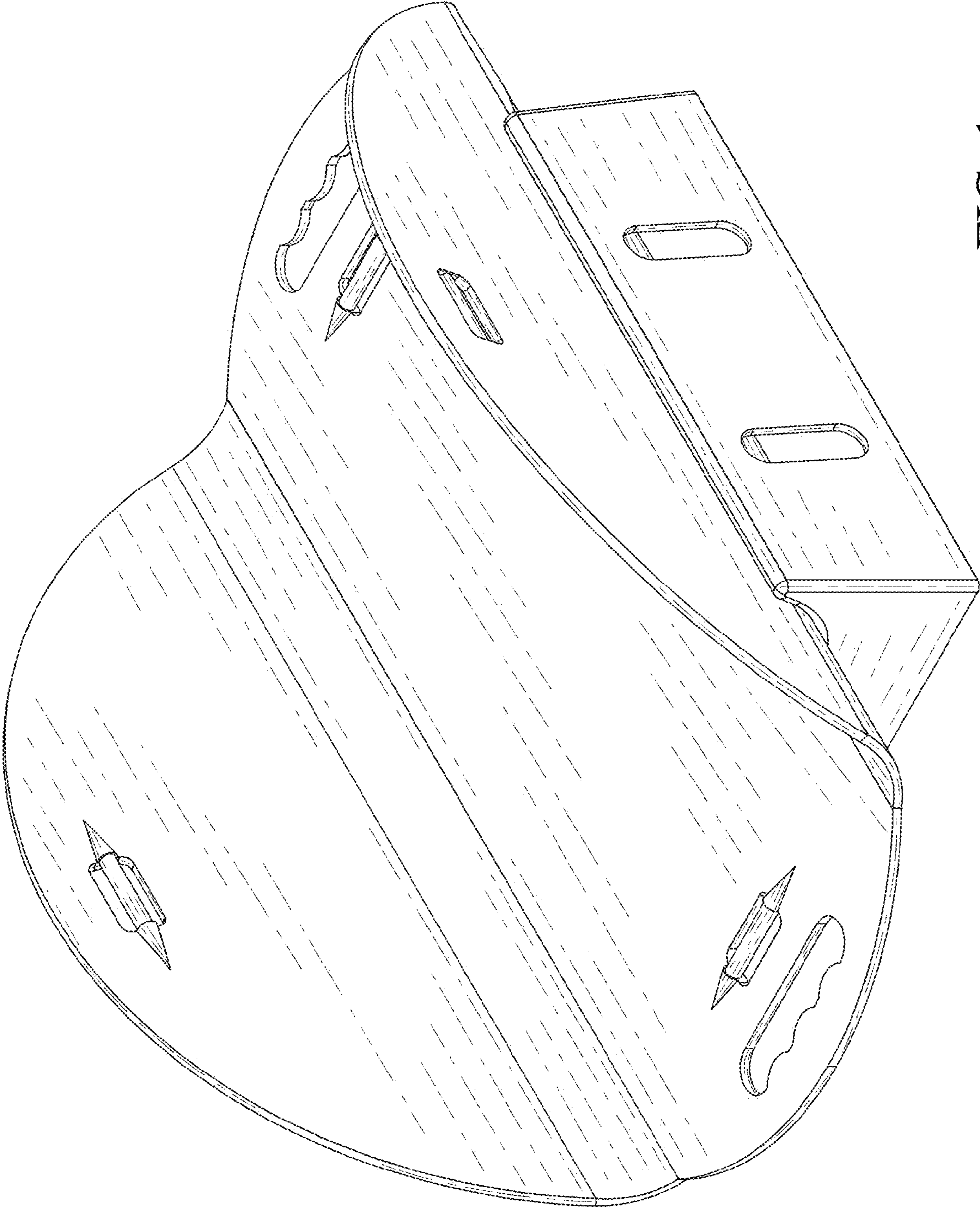

FIG. 1

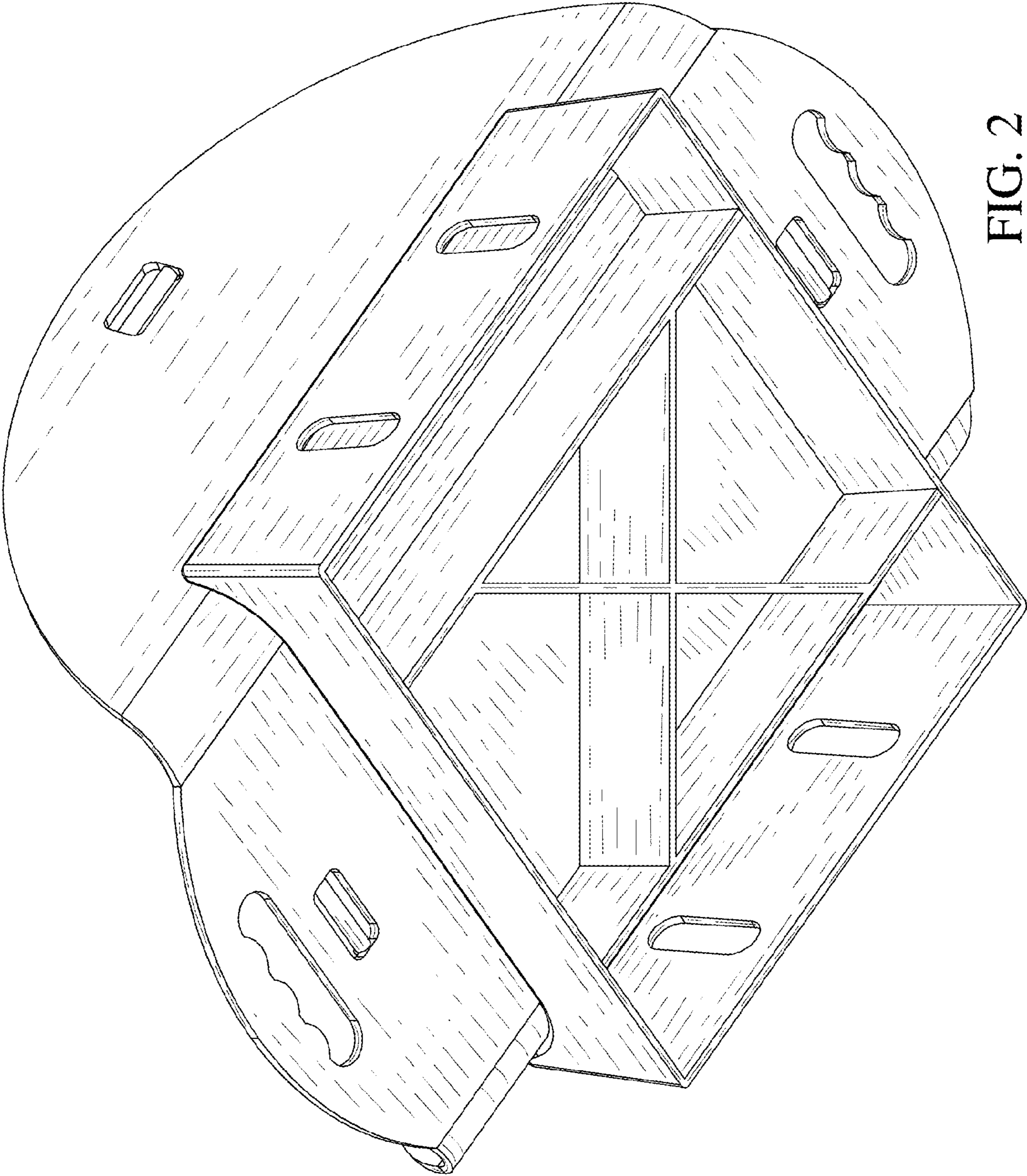

FIG. 2

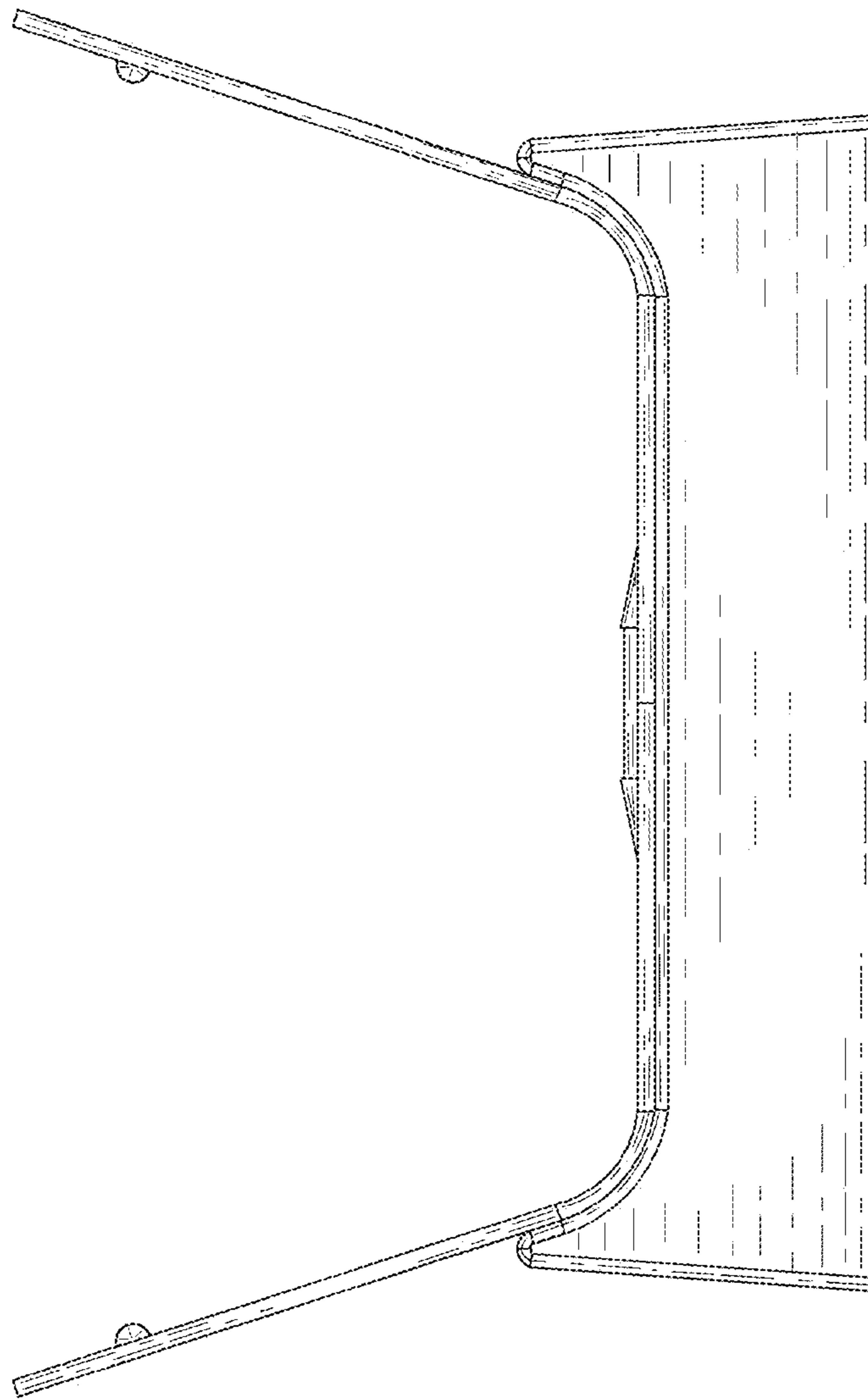

FIG. 3

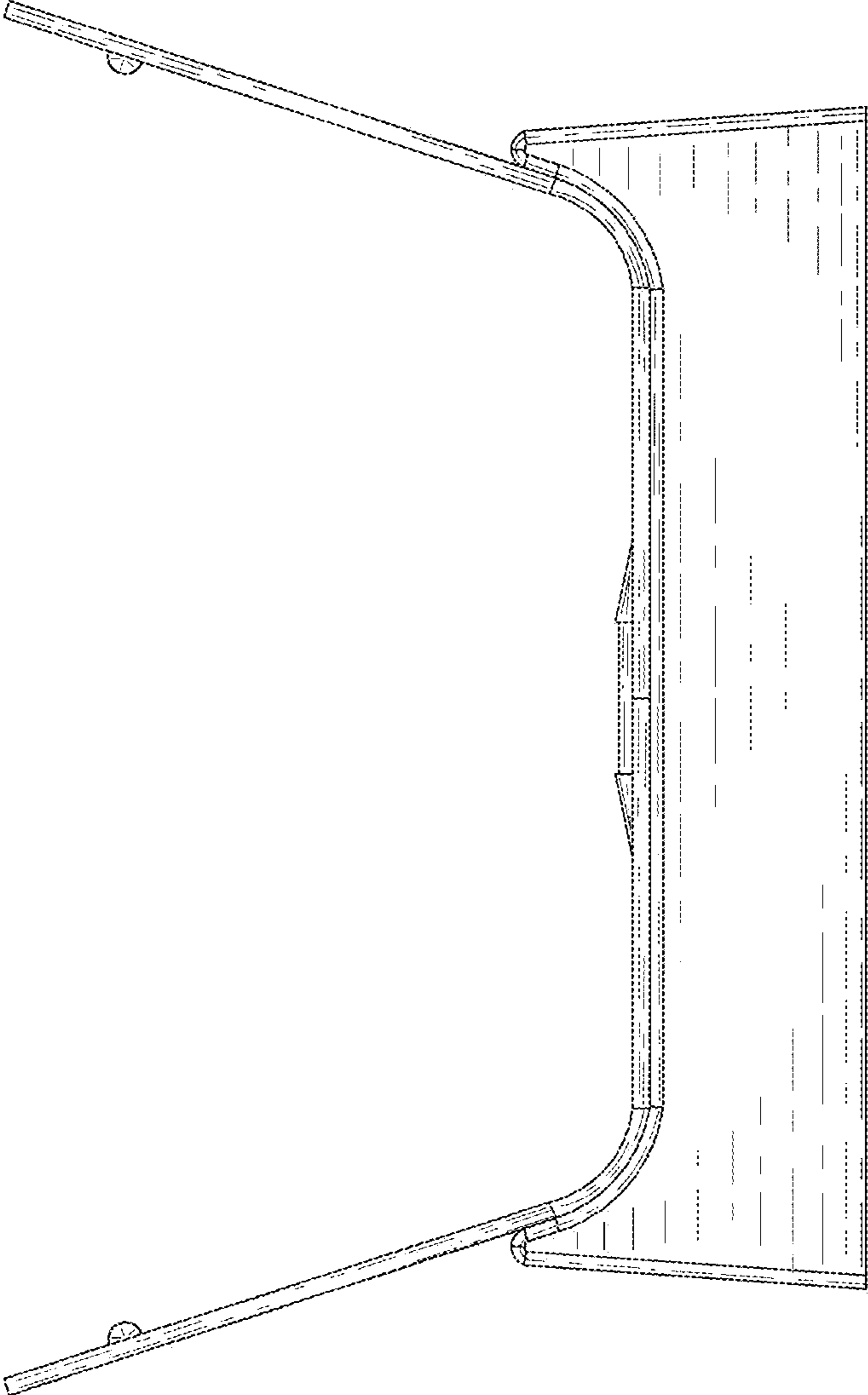

FIG. 4

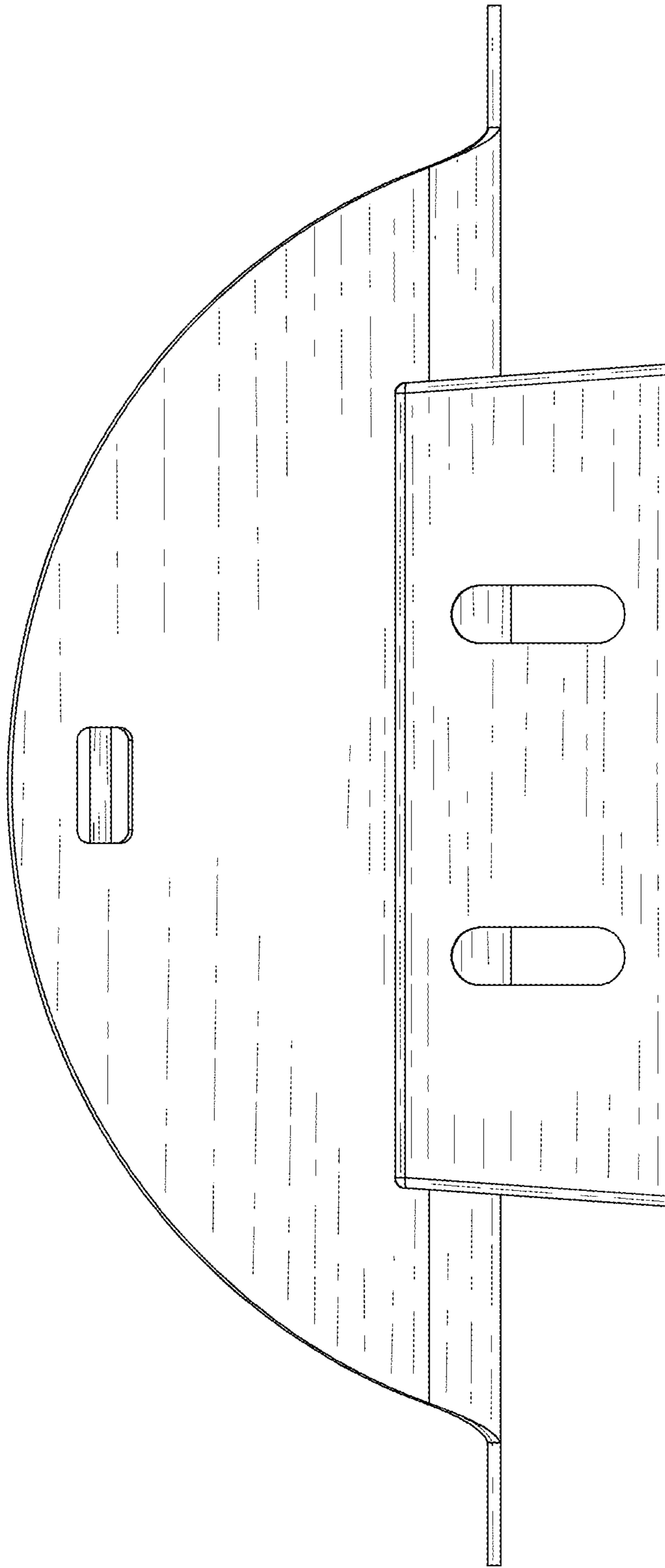

FIG. 5

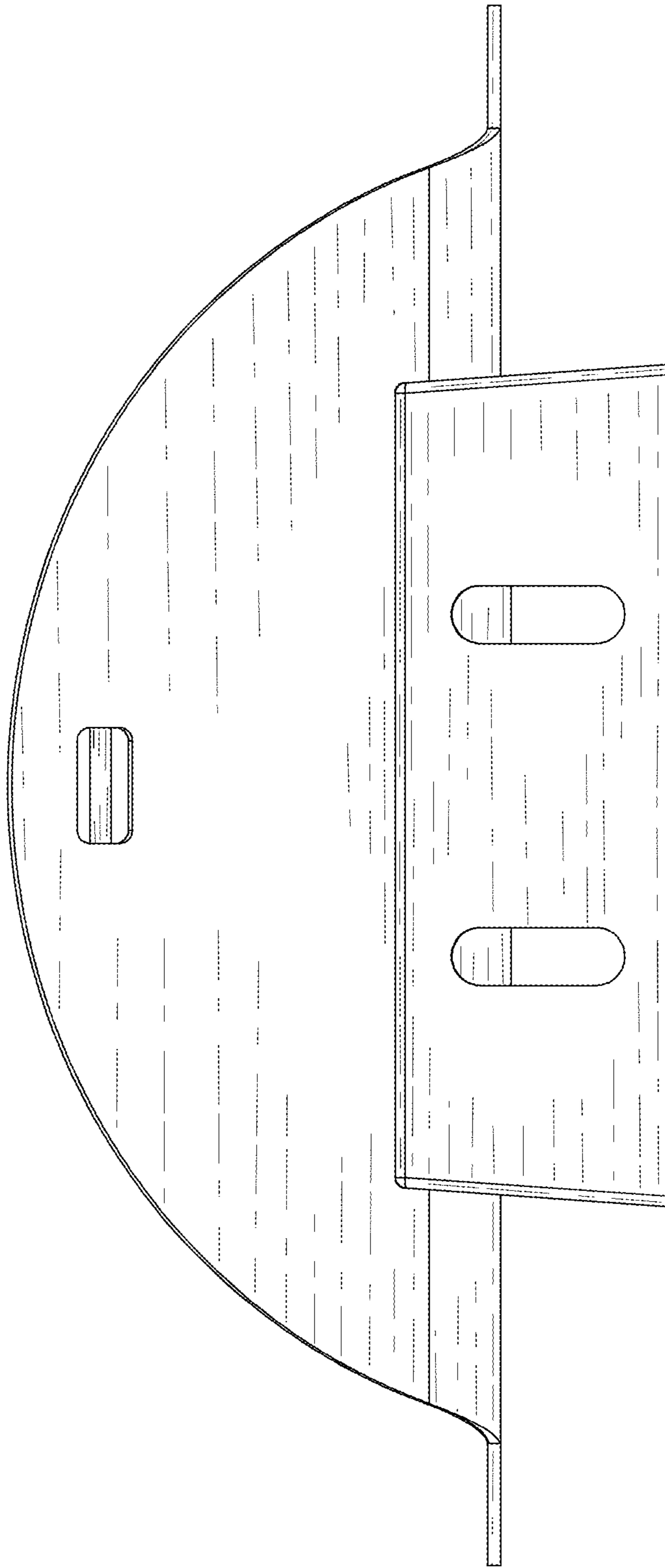

FIG. 6

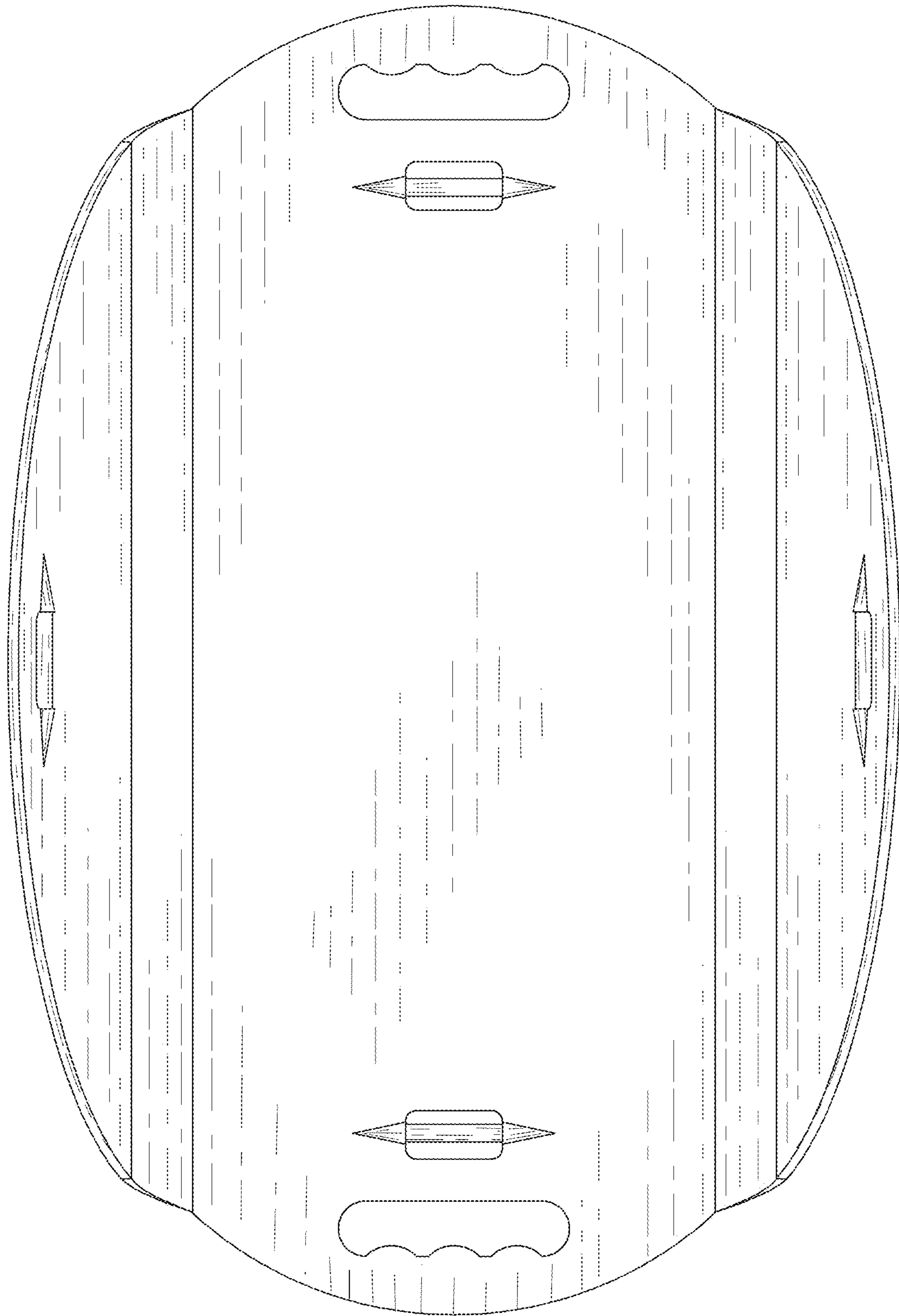

FIG. 7

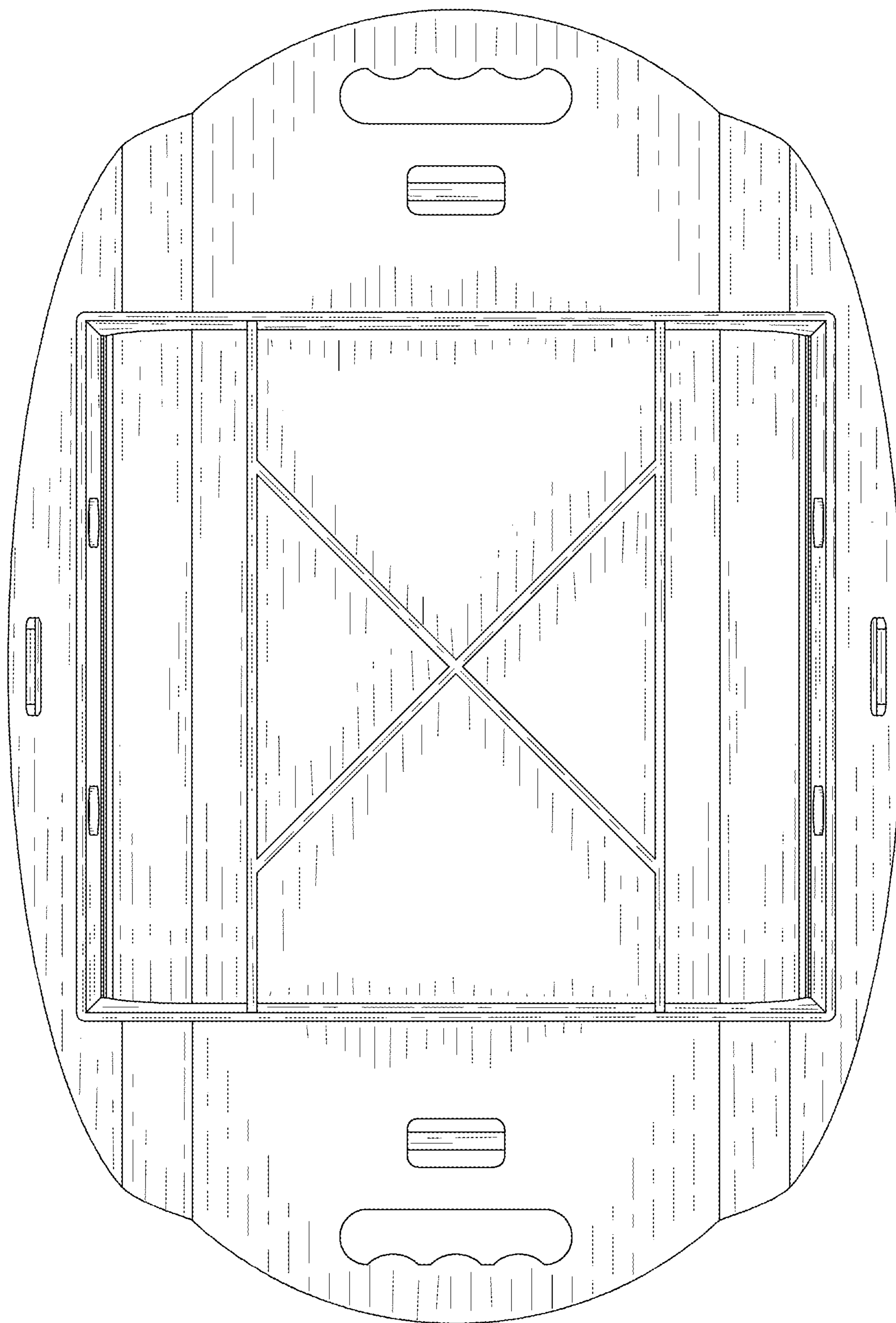

FIG. 8