



US00D881349S

(12) **United States Design Patent**
Stoler

(10) **Patent No.:** **US D881,349 S**

(45) **Date of Patent:** **** Apr. 14, 2020**

(54) **FAUCET SPOUT**

D598,984 S * 8/2009 Corbett D23/252
D690,397 S * 9/2013 Flowers D23/255
D797,894 S * 9/2017 Fritz D23/252

(71) Applicant: **DELTA FAUCET COMPANY,**
Indianapolis, IN (US)

(72) Inventor: **Benjamin David Stoler,** Carmel, IN
(US)

(73) Assignee: **DELTA FAUCET COMPANY,**
Indianapolis, IN (US)

(**) Term: **15 Years**

(21) Appl. No.: **29/641,822**

(22) Filed: **Mar. 26, 2018**

(51) **LOC (12) Cl.** **23-01**

(52) **U.S. Cl.**
USPC **D23/255**

(58) **Field of Classification Search**
USPC D23/238–243, 249, 255–257, 309
CPC ... Y10T 137/9464; E03C 1/04; E03C 1/0404;
E03C 1/0407
See application file for complete search history.

(56) **References Cited**

U.S. PATENT DOCUMENTS

D417,262 S * 11/1999 Caplow D23/255
D517,166 S * 3/2006 Chu D23/238
D564,075 S * 3/2008 Williams D23/238
D573,696 S * 7/2008 Eilmus D23/255

OTHER PUBLICATIONS

Amazon, Lavatory Faucet, posted Nov. 24, 2014, [online], [visited Apr. 19, 2019]. Internet, <URL: https://www.amazon.co.uk/Isenberg-R1001CP-Single-Lavatory-Faucet/dp/B00MXCIZ8W/ref=olp_product_details?_encoding=UTF8&me=> (Year: 2014).*

* cited by examiner

Primary Examiner — Sheryl Lane

Assistant Examiner — Samantha N Wood

(74) *Attorney, Agent, or Firm* — Edgar A. Zarins; Nirav D. Parikh

(57) **CLAIM**

The ornamental design for a faucet spout, as shown and described.

DESCRIPTION

FIG. 1 is a first perspective view of a faucet spout showing my new design;

FIG. 2 is a second perspective view thereof;

FIG. 3 is a front elevational view thereof;

FIG. 4 is a left side view thereof;

FIG. 5 is a rear view thereof;

FIG. 6 is a right side view thereof; and,

FIG. 7 is a top plan view thereof.

1 Claim, 4 Drawing Sheets

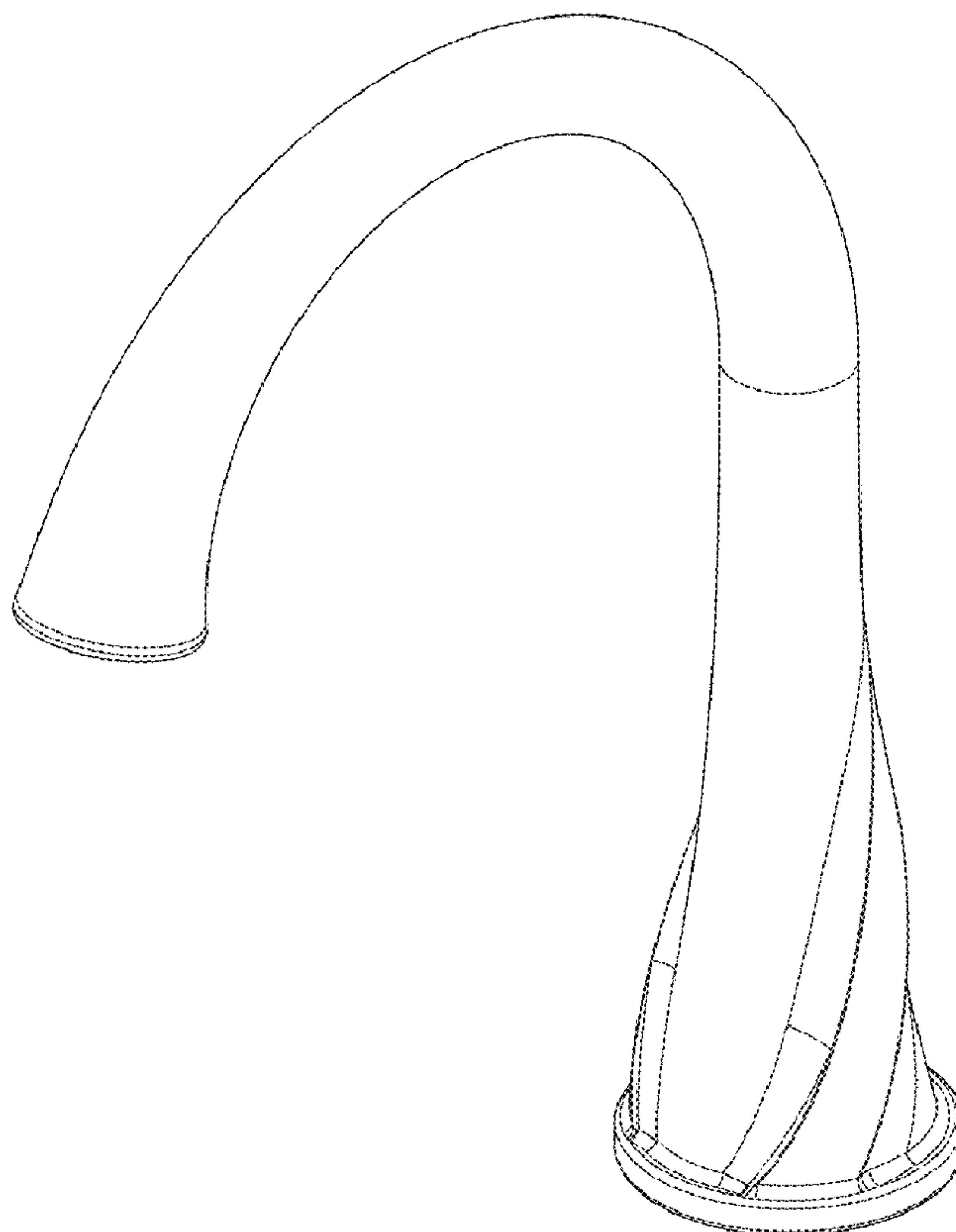

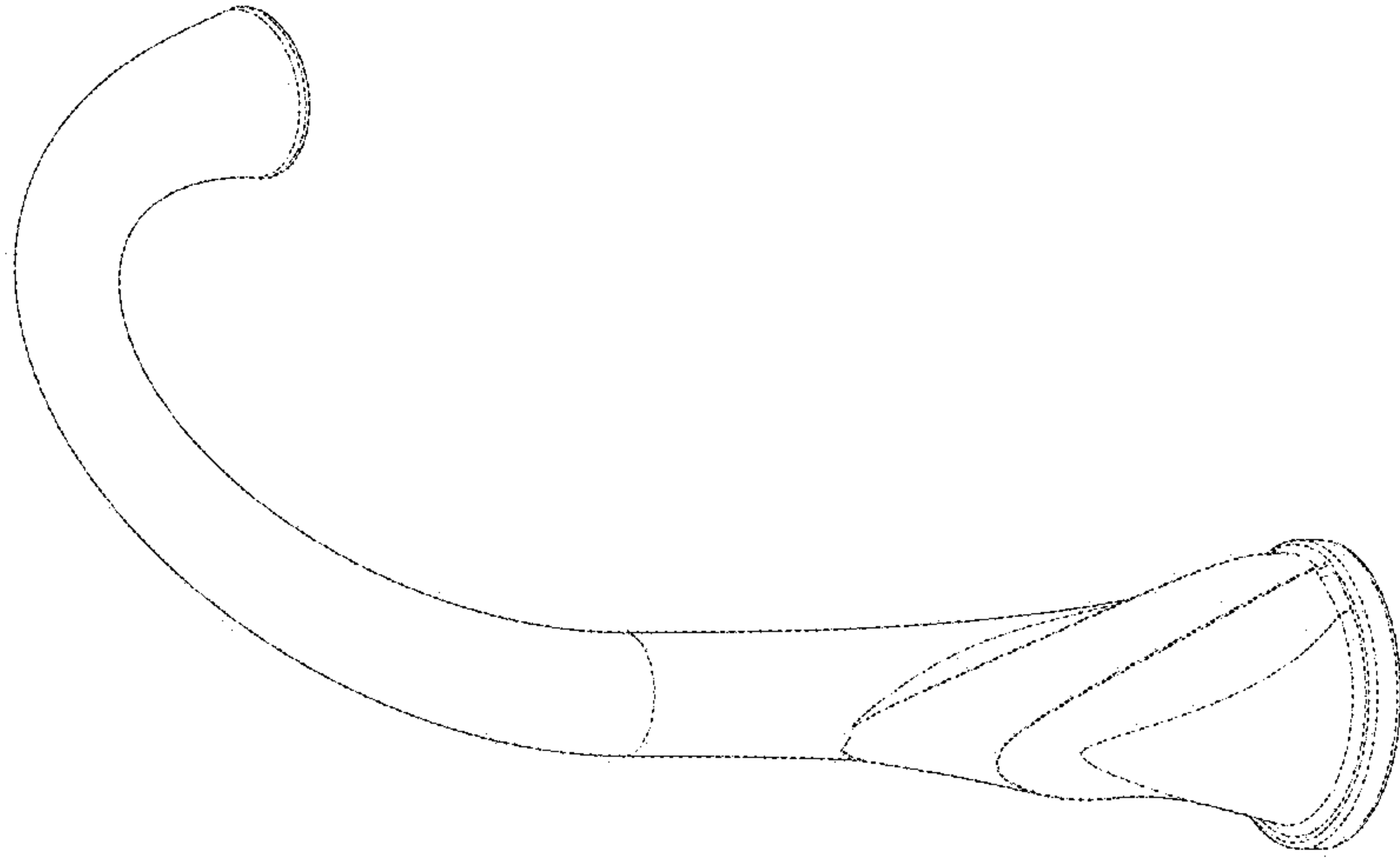

FIG - 2

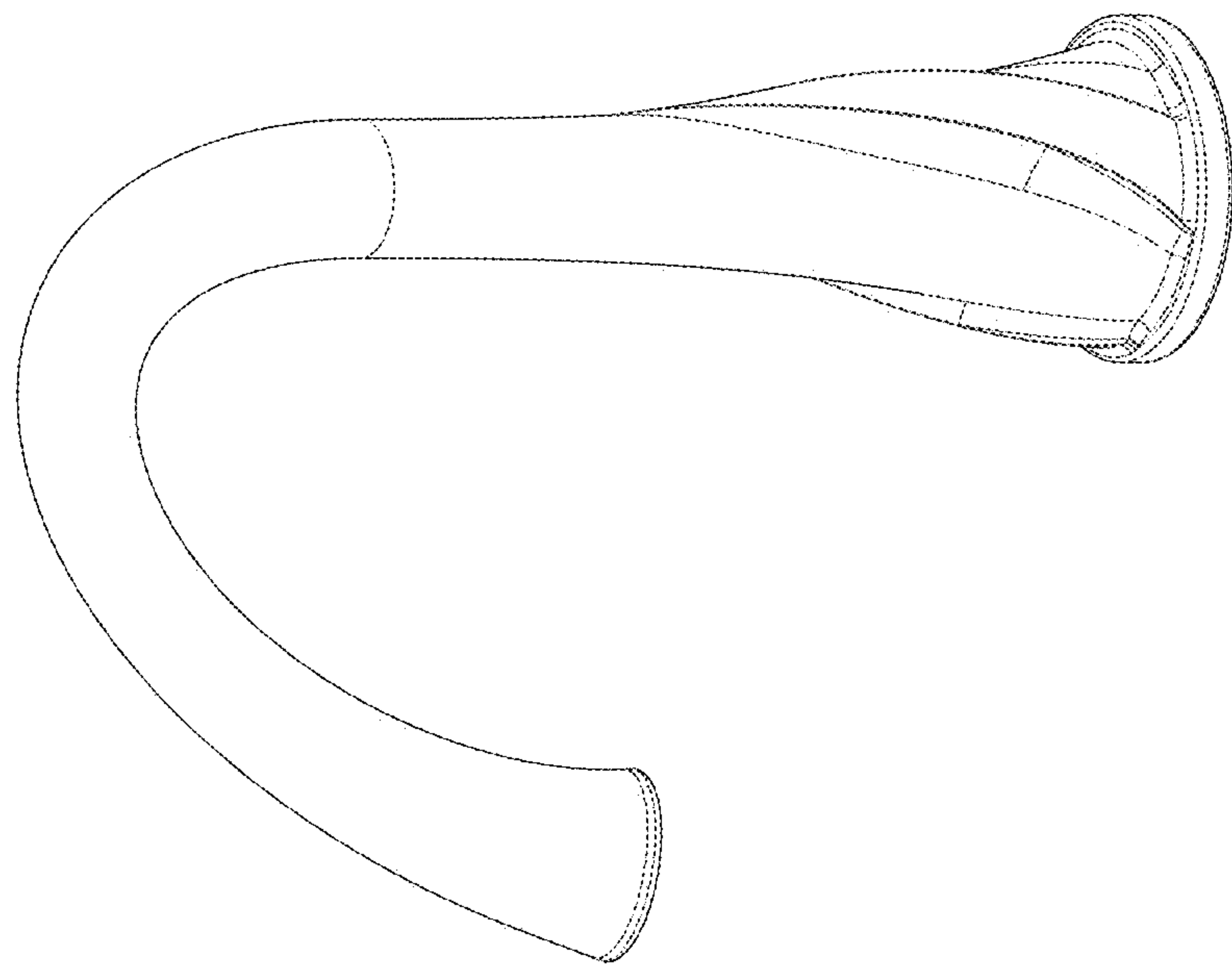

FIG - 1

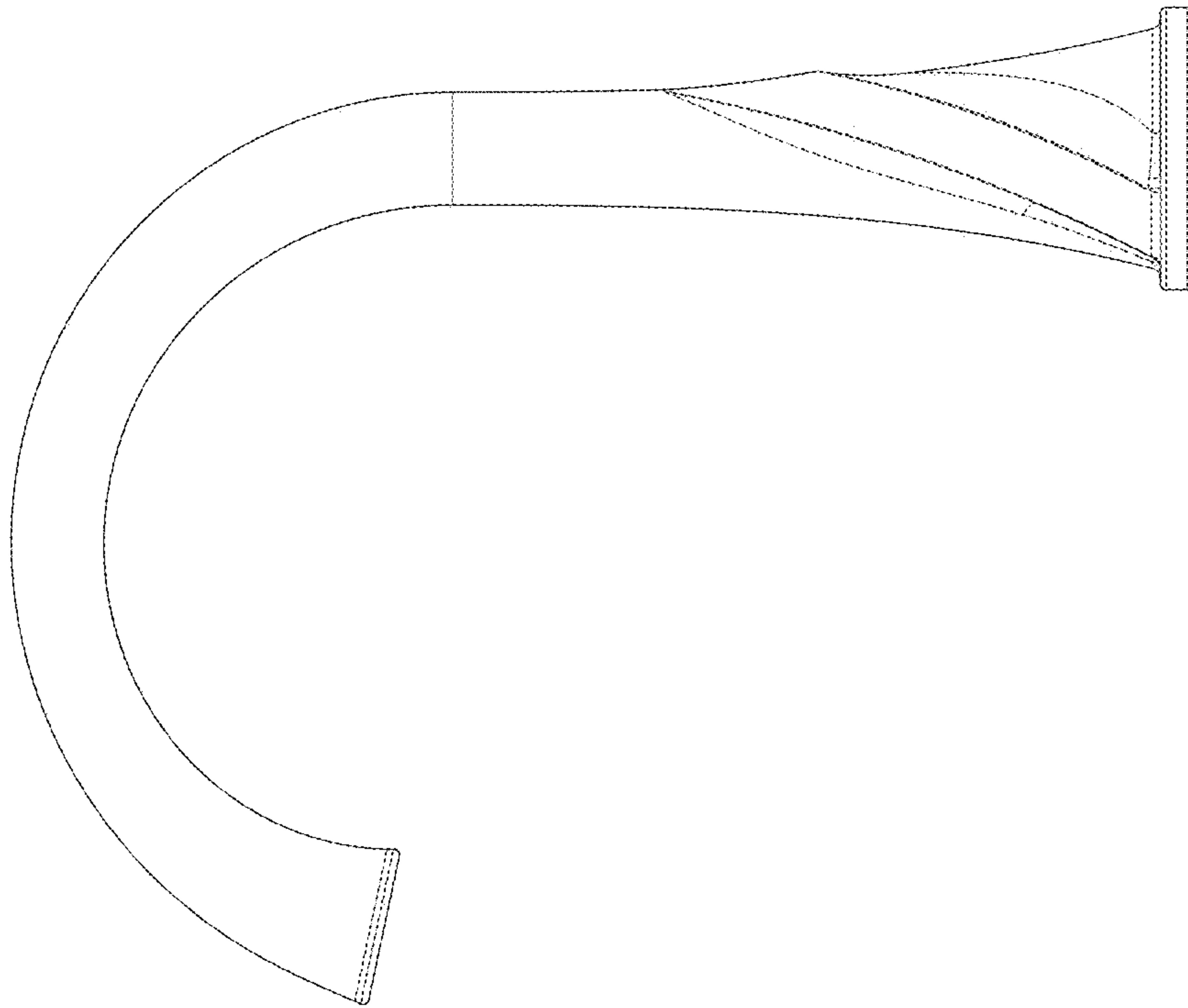

FIG - 4

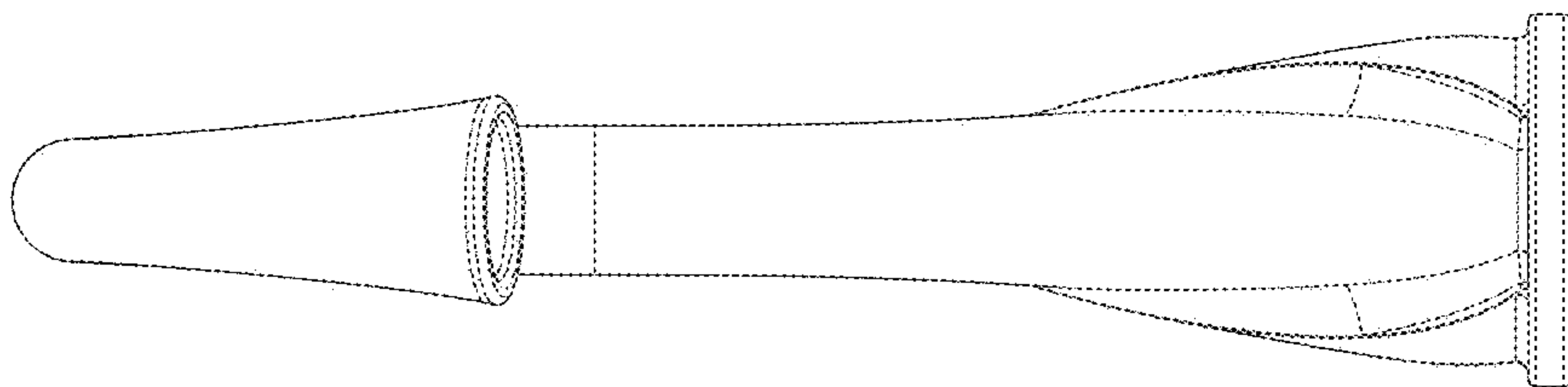

FIG - 3

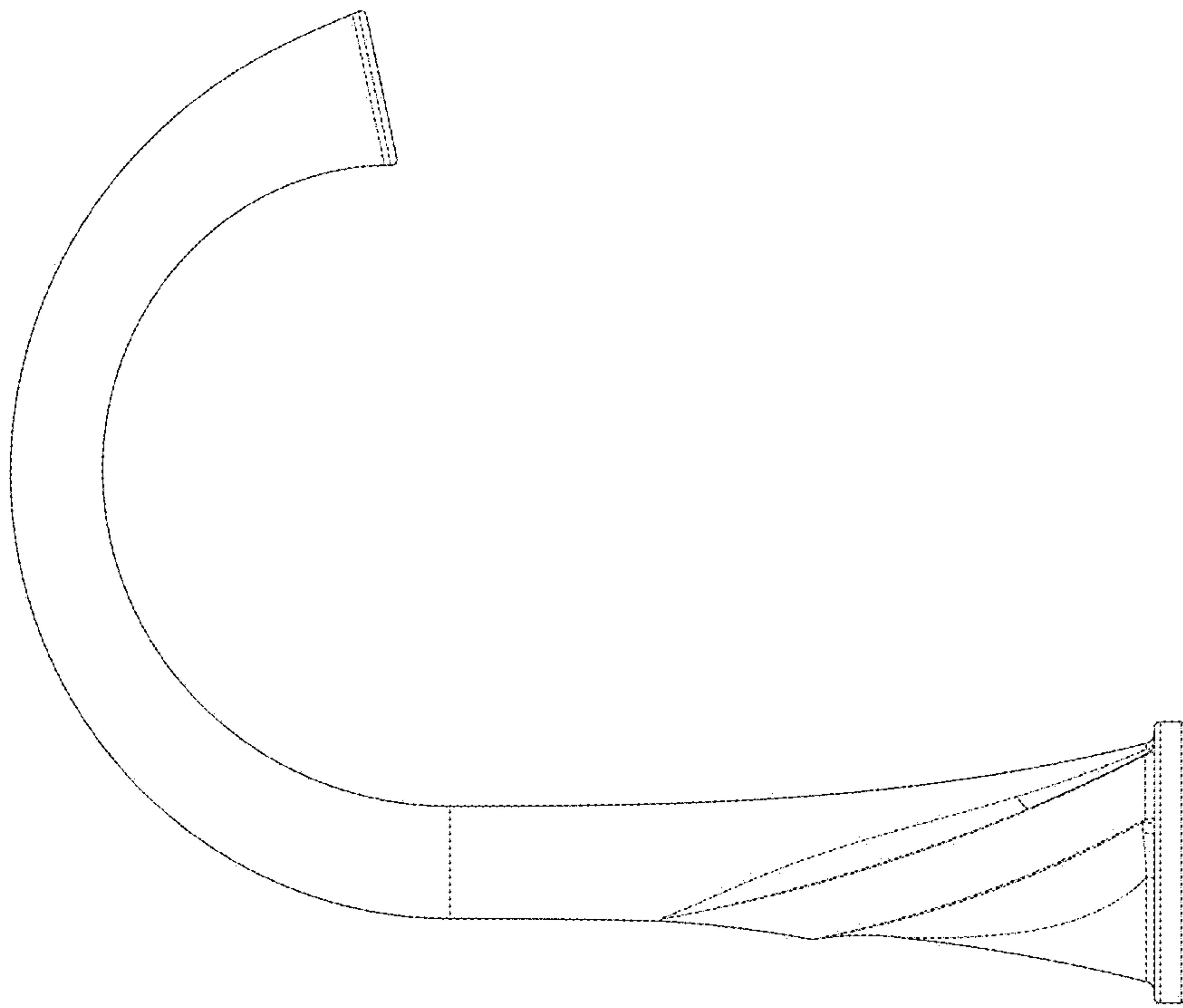

FIG - 6

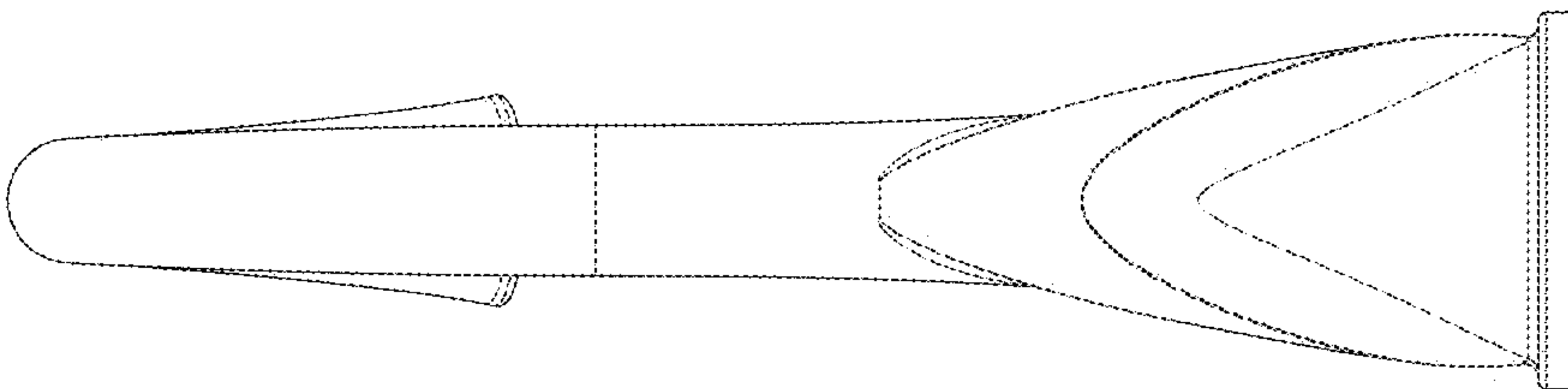

FIG - 5

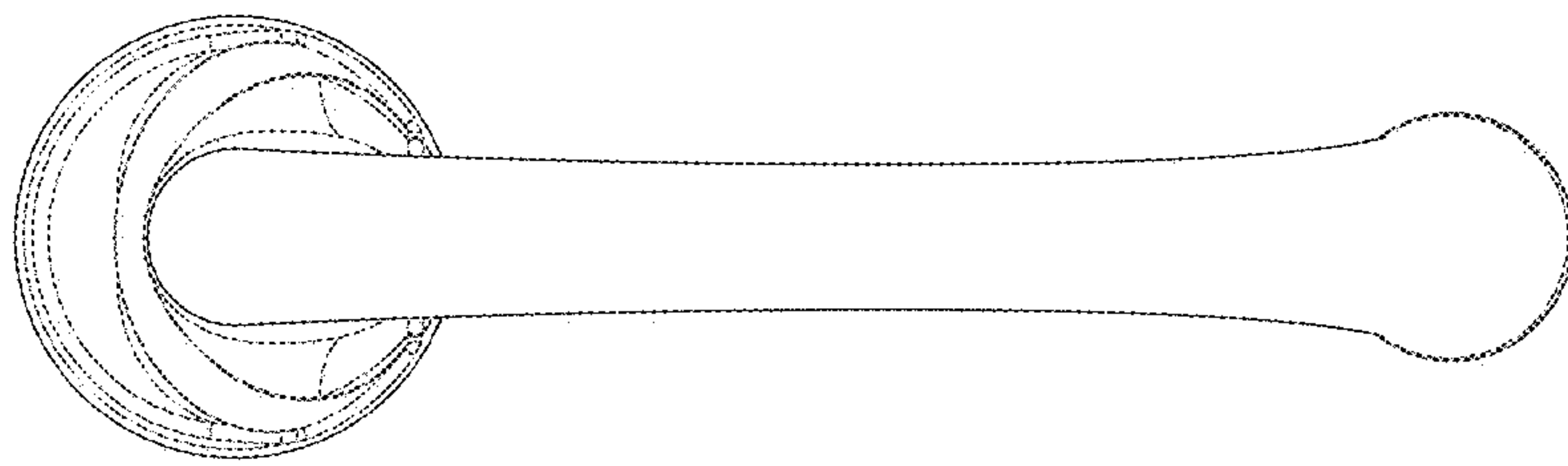

FIG - 7