



US00D881333S

(12) **United States Design Patent**
McKeral, Jr.

(10) **Patent No.:** **US D881,333 S**
(45) **Date of Patent:** **** Apr. 14, 2020**

(54) **FISH CARICATURE LURE/NOVELTY**

(57) **CLAIM**

(71) Applicant: **Jimmie John McKeral, Jr.**, Hiawassee,
GA (US)

The ornamental design for a fish caricature lure/novelty,
substantially as shown and described.

(72) Inventor: **Jimmie John McKeral, Jr.**, Hiawassee,
GA (US)

DESCRIPTION

(**) Term: **15 Years**

(21) Appl. No.: **29/633,802**

(22) Filed: **Jan. 16, 2018**

(51) **LOC (12) Cl.** **22-05**

(52) **U.S. Cl.**
USPC **D22/133**

(58) **Field of Classification Search**
USPC D22/131, 133; 43/42.51, 42.27, 42.11,
43/42.14, 42.15, 42.16, 42.35, 42.36,
43/42.45, 42.48; D21/606, 597, 599
CPC A01K 85/01; A01K 85/12; A01K 85/16;
A01K 85/18

See application file for complete search history.

FIG. 1 is a perspective view of a fish caricature lure/novelty
according to an embodiment of the design.

FIG. 2 is a top view of the fish caricature lure/novelty of
FIG. 1.

FIG. 3 is a bottom view of the fish caricature lure/novelty of
FIG. 1.

FIG. 4 is a right side view of the fish caricature lure/novelty
of FIG. 1.

FIG. 5 is a left side view of the fish caricature lure/novelty
of FIG. 1.

FIG. 6 is a front view of the fish caricature lure/novelty of
FIG. 1.

FIG. 7 is a rear view of the fish caricature lure/novelty of
FIG. 1.

FIG. 8 is a perspective view of a fish caricature lure/novelty
according to a second embodiment of the design.

FIG. 9 is a top view of the fish caricature lure/novelty of
FIG. 8.

FIG. 10 is a bottom view of the fish caricature lure/novelty
of FIG. 8.

FIG. 11 is a right side view of the fish caricature lure/novelty
of FIG. 8.

FIG. 12 is a left side view of the fish caricature lure/novelty
of FIG. 8.

FIG. 13 is a front view of the fish caricature lure/novelty of
FIG. 8.

FIG. 14 is a rear view of the fish caricature lure/novelty of
FIG. 8.

FIG. 15 is a perspective view of a fish caricature lure/novelty
according to a third embodiment of the design.

FIG. 16 is a top view of the fish caricature lure/novelty of
FIG. 15.

FIG. 17 is a bottom view of the fish caricature lure/novelty
of FIG. 15.

FIG. 18 is a right side view of the fish caricature lure/novelty
of FIG. 15.

(56) **References Cited**

U.S. PATENT DOCUMENTS

1,188,583 A * 6/1916 Townsend A01K 85/16
43/42.16
1,828,574 A * 10/1931 Neukam A01K 85/18
43/42.15

(Continued)

OTHER PUBLICATIONS

Carolina Lures Mr. Mahi Mini Yummee Flying Fish High Speed
Daisy Chain, BassProShops.com, 2006-2019.*

(Continued)

Primary Examiner — Catherine R Oliver-Garcia
(74) *Attorney, Agent, or Firm* — Gardner Groff &
Greenwald, PC

(Continued)

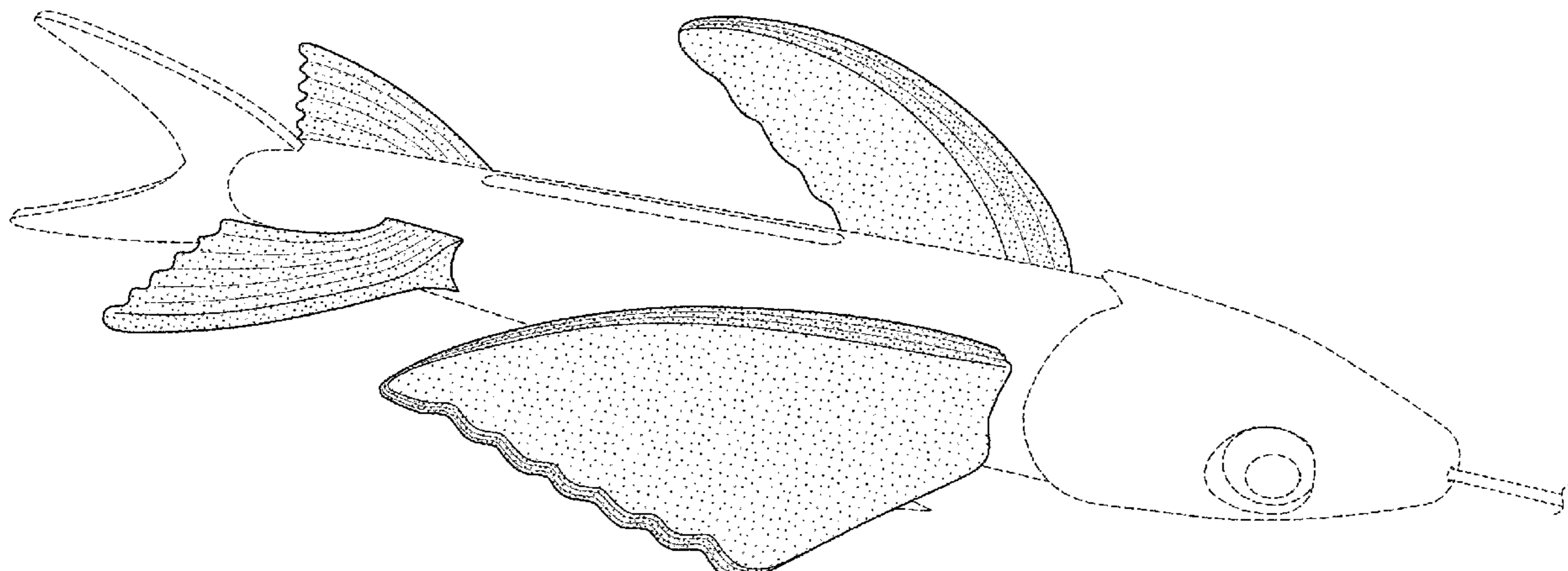

FIG. 19 is a left side view of the fish caricature lure/novelty of FIG. 15.

FIG. 20 is a front view of the fish caricature lure/novelty of FIG. 15.

FIG. 21 is a rear view of the fish caricature lure/novelty of FIG. 15.

FIG. 22 is a perspective view of a fish caricature lure/novelty according to a fourth embodiment of the design.

FIG. 23 is a top view of the fish caricature lure/novelty of FIG. 22.

FIG. 24 is a bottom view of the fish caricature lure/novelty of FIG. 22.

FIG. 25 is a right side view of the fish caricature lure/novelty of FIG. 22.

FIG. 26 is a left side view of the fish caricature lure/novelty of FIG. 22.

FIG. 27 is a front view of the fish caricature lure/novelty of FIG. 22; and,

FIG. 28 is a rear view of the fish caricature lure/novelty of FIG. 22.

The portions shown in broken lines depict environmental structure and are included for illustrative purposes only and form no part of the claimed design.

1 Claim, 24 Drawing Sheets

(56)

References Cited

U.S. PATENT DOCUMENTS

2,494,407 A * 1/1950 Rhodes A01K 85/12
43/42.05
D170,594 S * 10/1953 Leonard et al. D21/599

2,853,826 A * 9/1958 Romeo A01K 85/01
43/42.31
D190,427 S * 5/1961 Ogletree D22/131
D228,184 S * 8/1973 Harris D22/128
D347,393 S * 5/1994 Young D21/597
D369,200 S * 4/1996 Huddleston D22/133
D503,440 S * 3/2005 Weiser D21/599

OTHER PUBLICATIONS

AkoaDa 2019 Seawater Fishing Lure Flying Fish 18cm Soft Bait Fishing Lure Sea Angling Curly Trolling Tuna Mackerel Fishing Lures, Walmart.com (Year: 2019).*

8" Blue Pearl Flying Fish—Mahi Tuna Wahoo Lure by Magbay Lures, Ebay.com, 1995-2019.*

Yummee Bird 7 inch Flying Fish “Florida Fishing Weekly” Apr. 28, 2006.

Blue Back Yummee Flying Fish “Big Game Fishing Journal” Nov. 2002, p. 79.

Green Back Yummee Flying Fish “Offshore Angler Catalog” 2002, p. 81.

Yo-zuri Flying Fish Lure, prior 2006.

Carolina Lures Blue Crystal Yummee Flying Fish, Captin Harry’s Website, Apr. 2005.

4 Inch Mini Flying Fish, 2005.

7 Inch Delta Wing Flying Fish, 2004.

9 Inch Swimming Flying Fish, 2002.

* cited by examiner

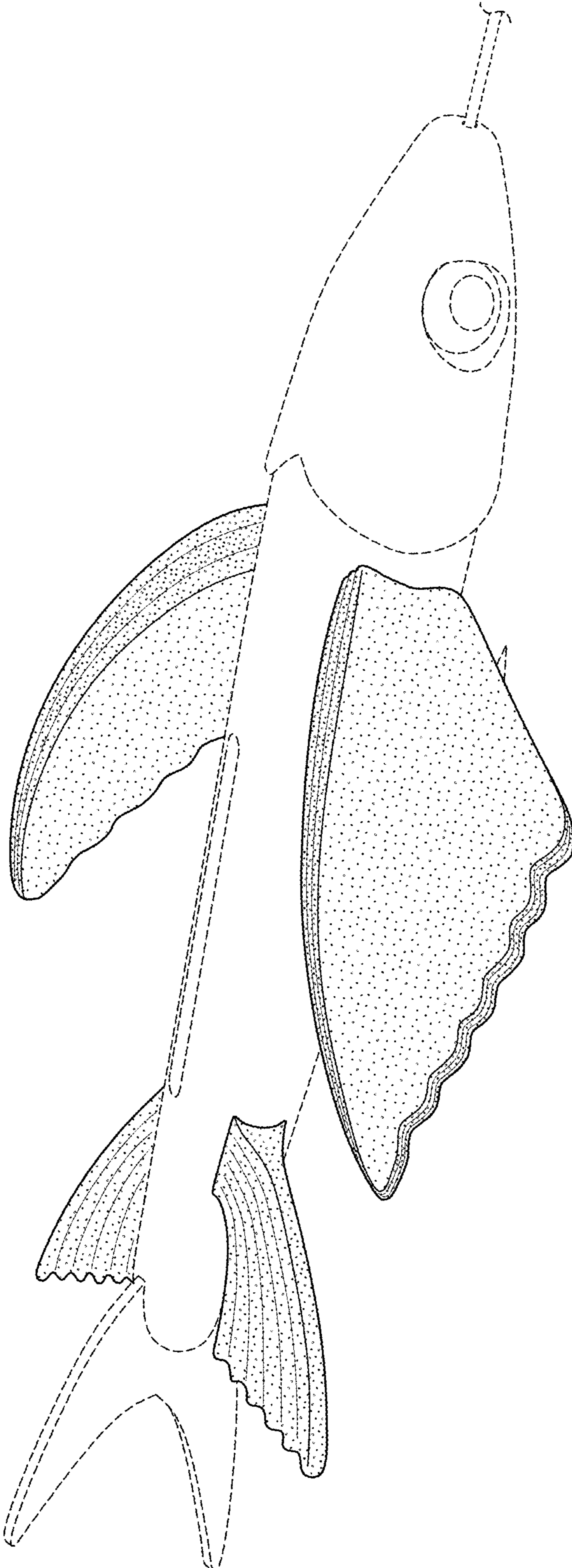

FIG. 1

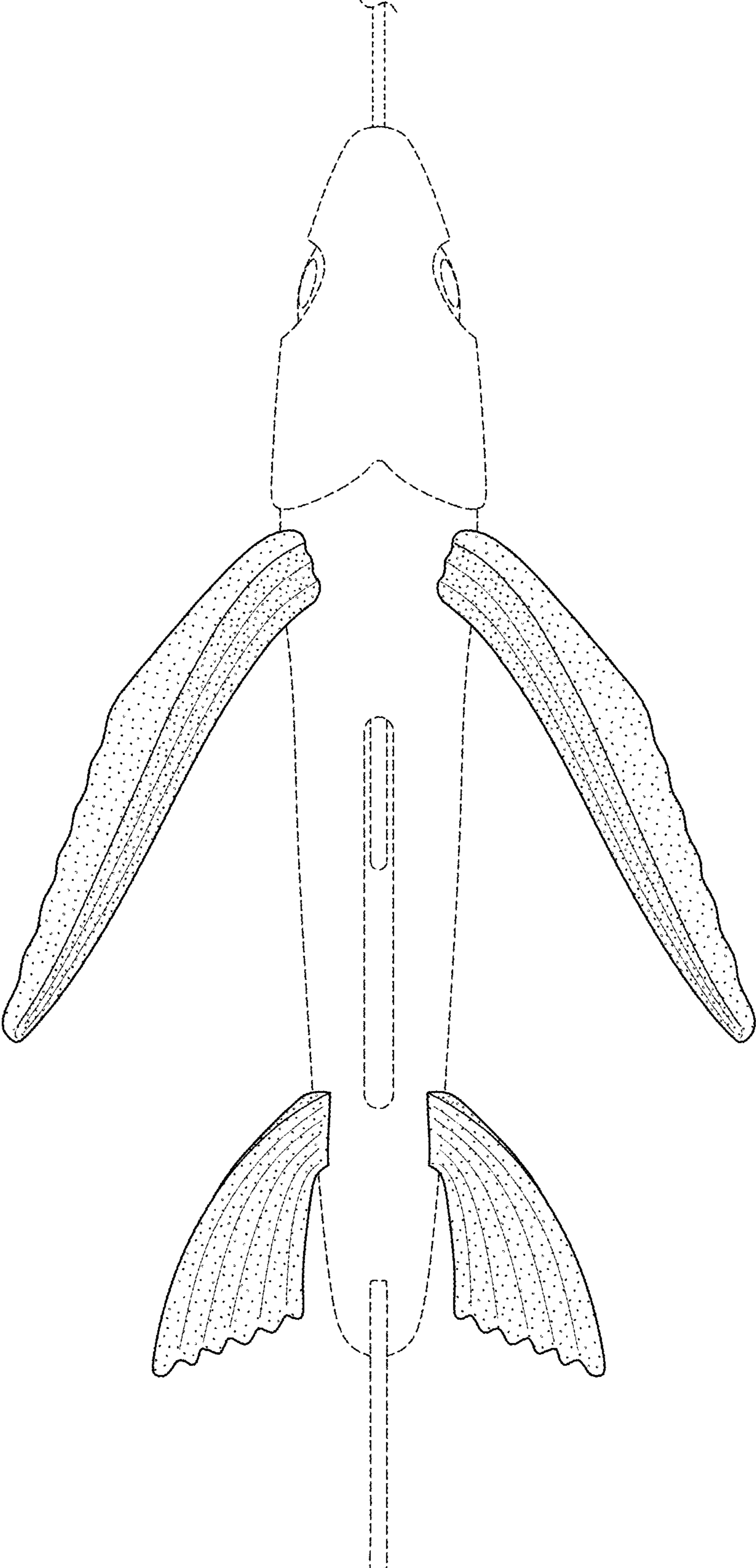

FIG. 2

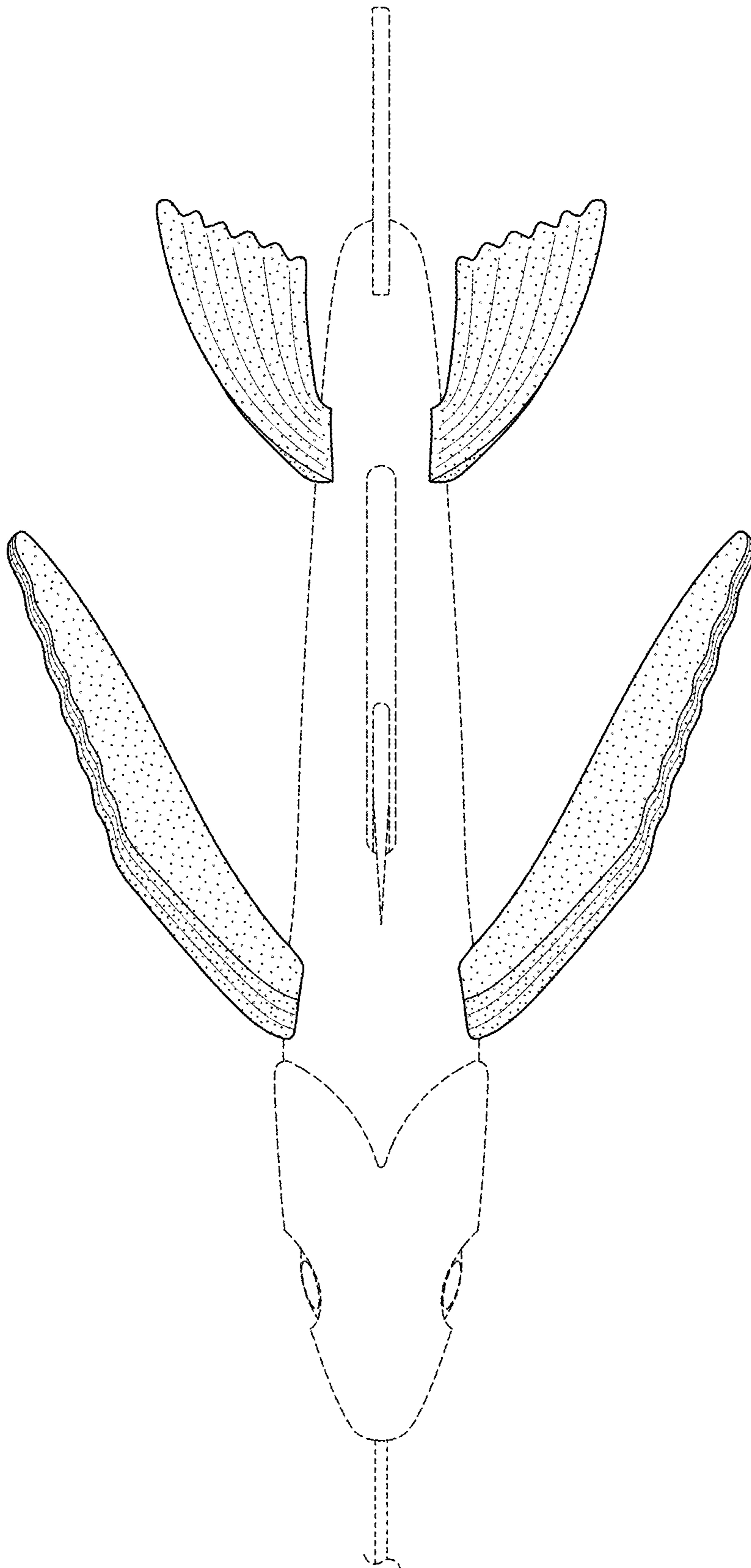

FIG. 3

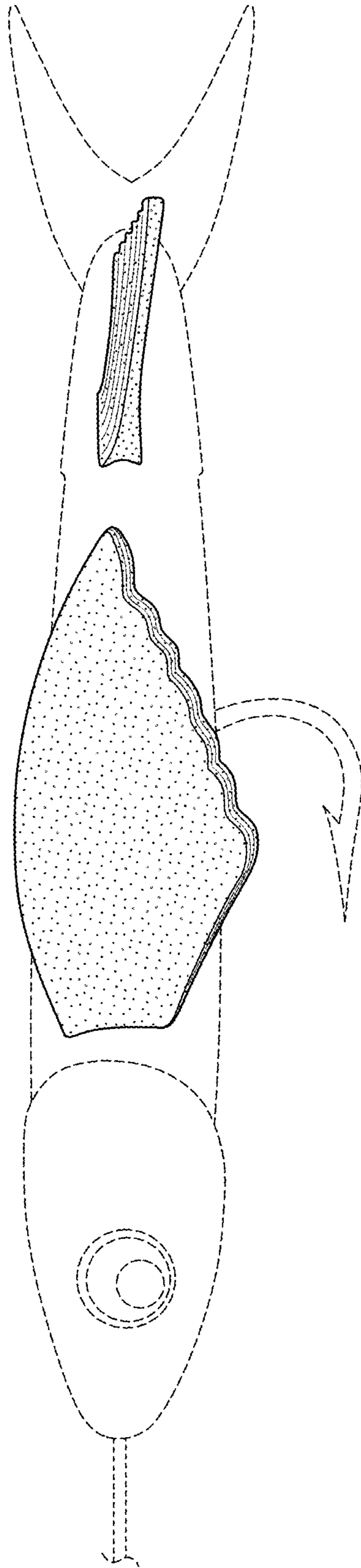

FIG. 4

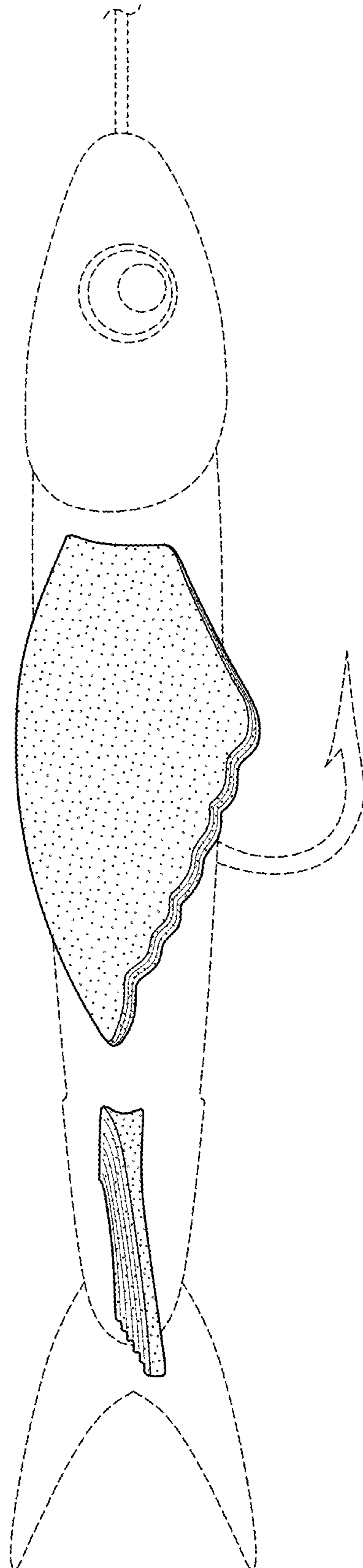

FIG. 5

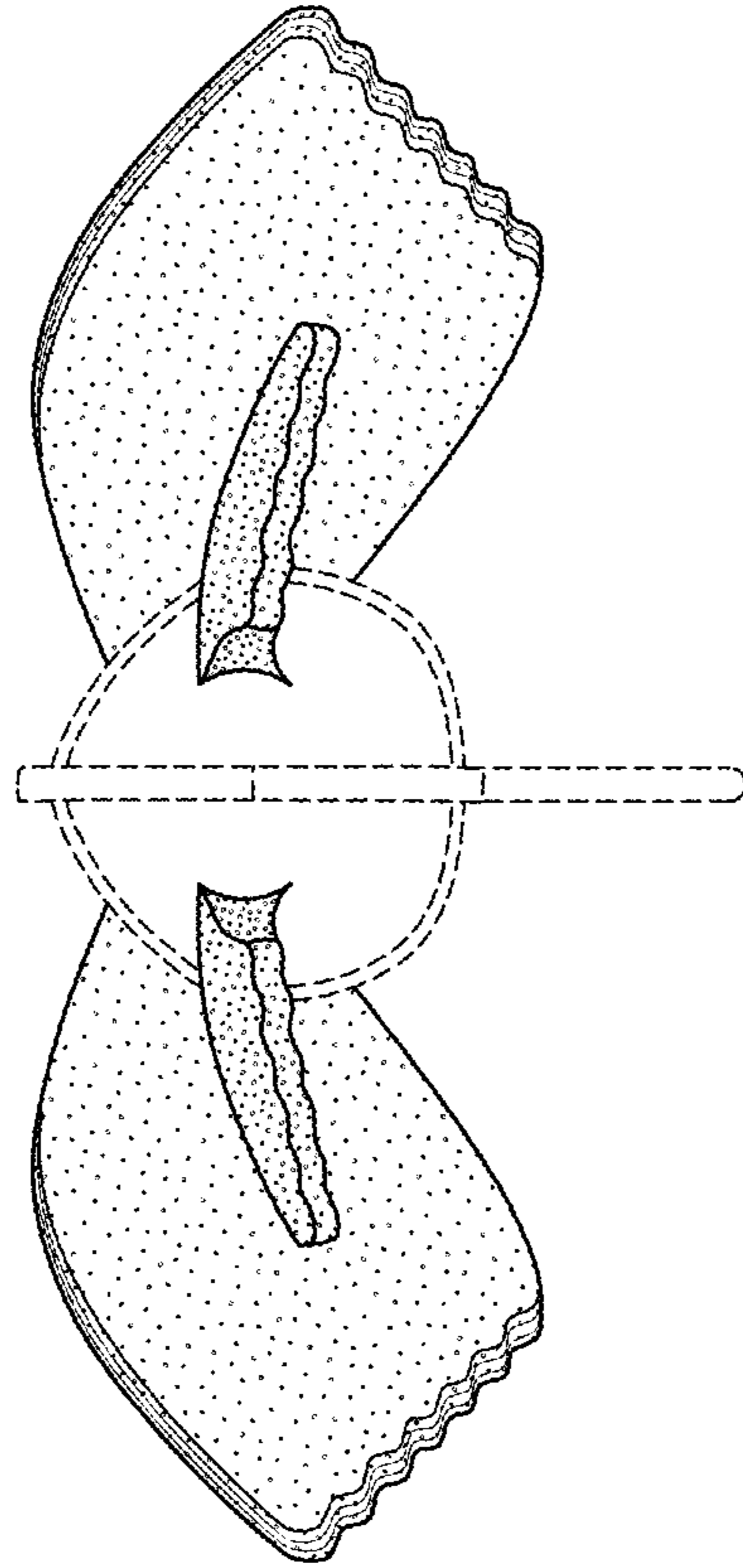

FIG. 7

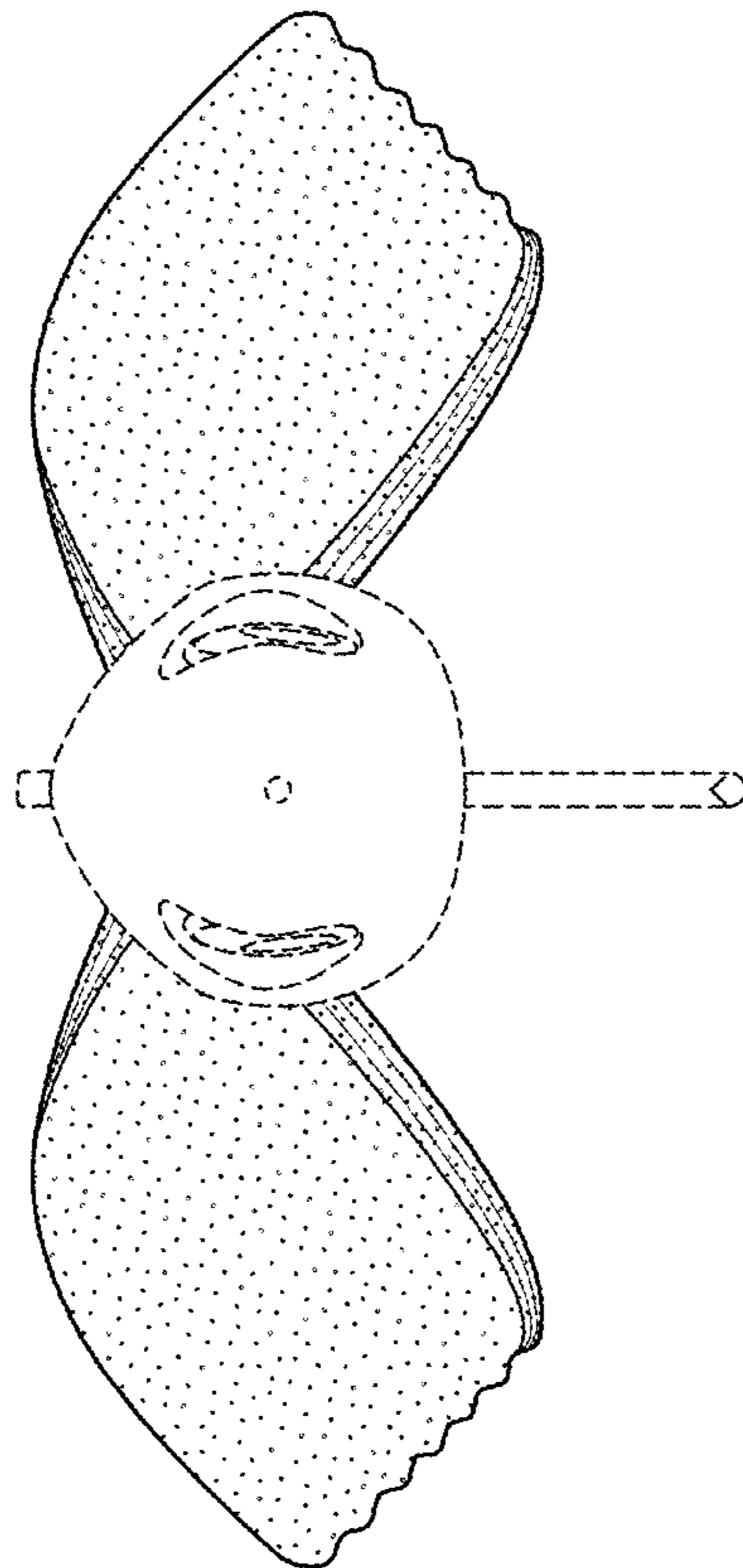

FIG. 6

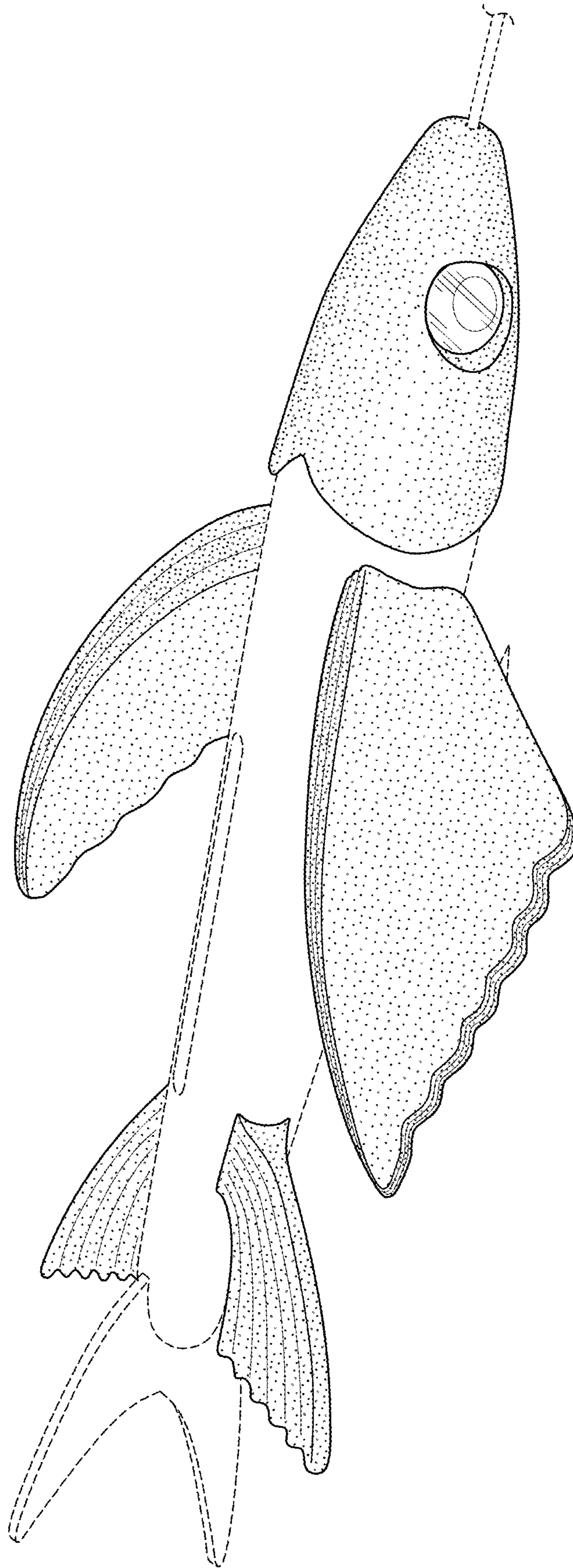

FIG. 8

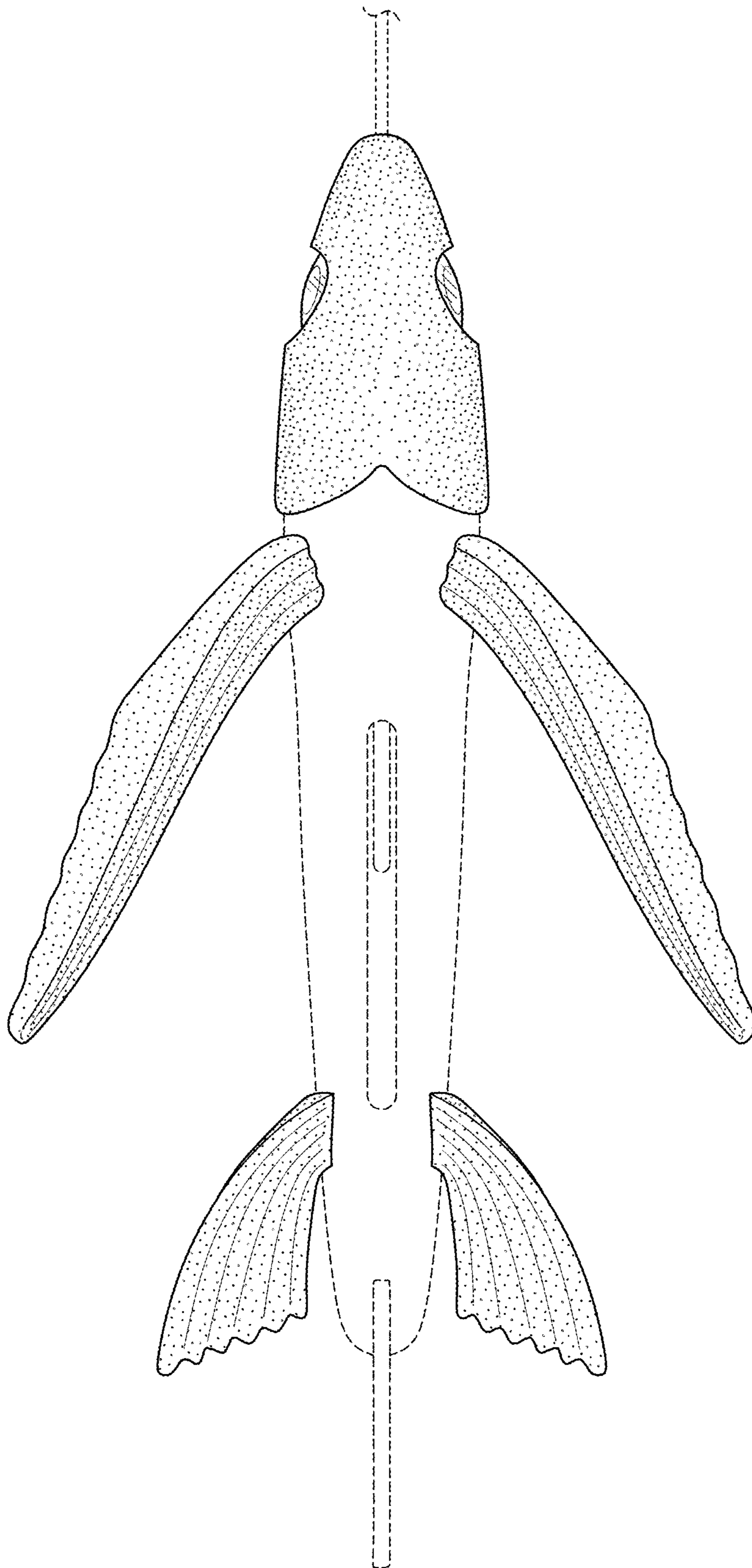

FIG. 9

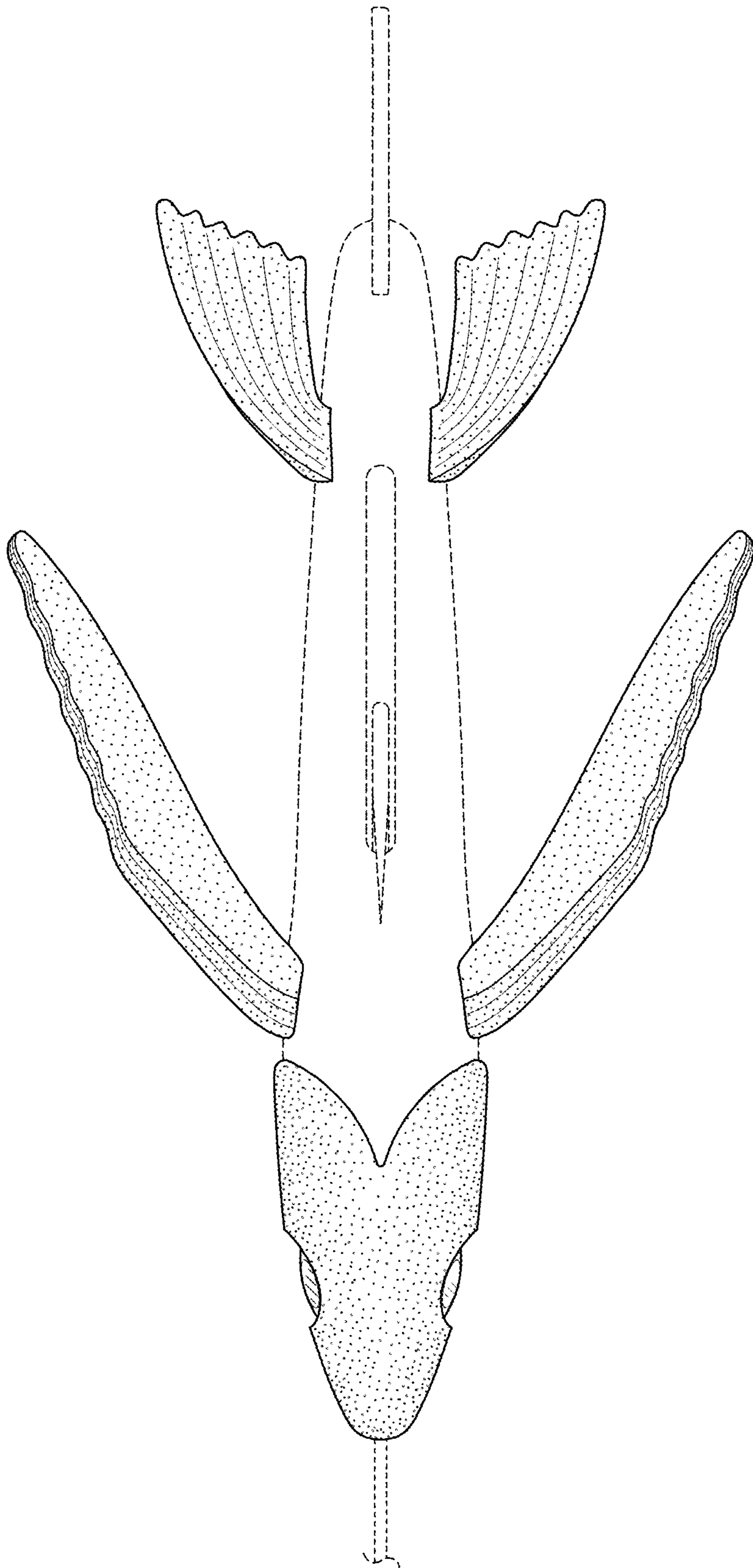

FIG. 10

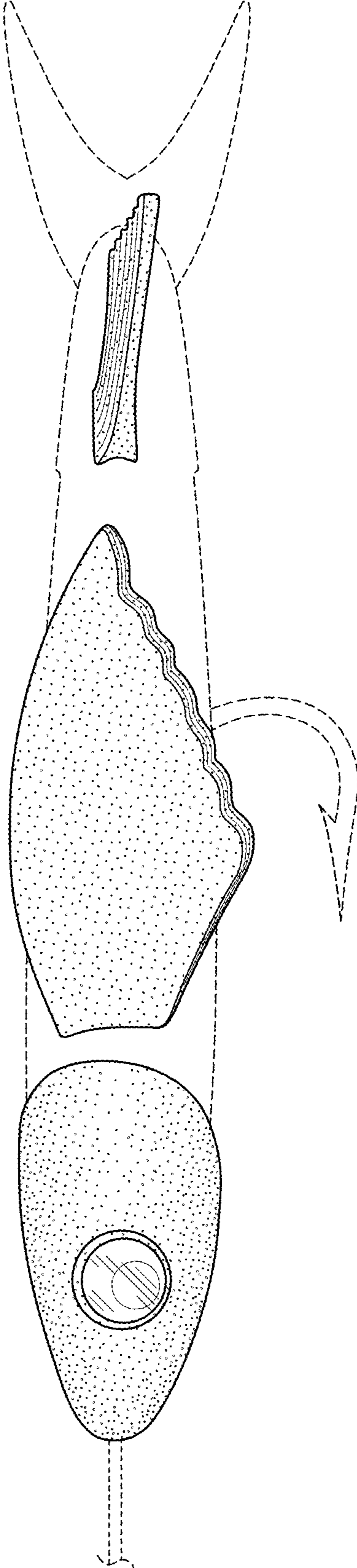

FIG. 11

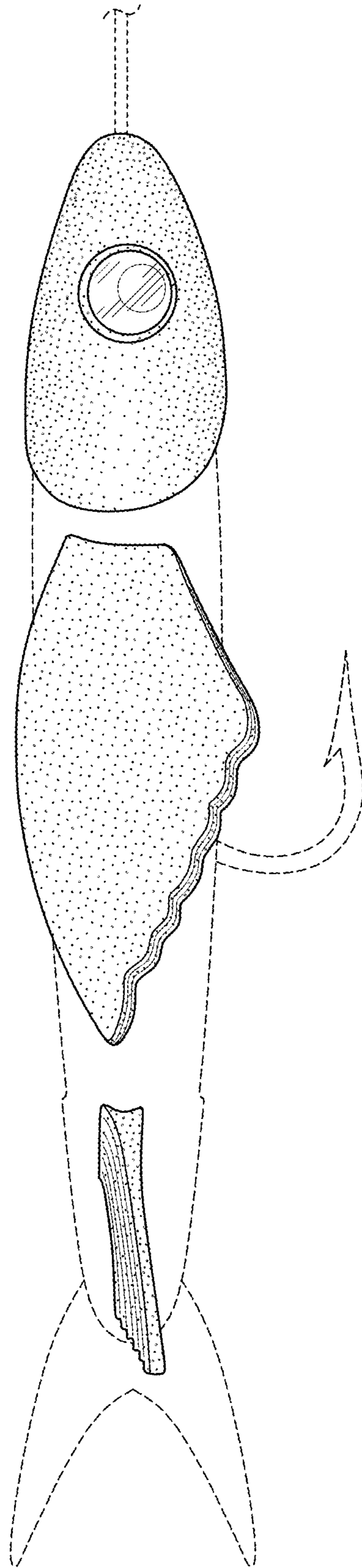

FIG. 12

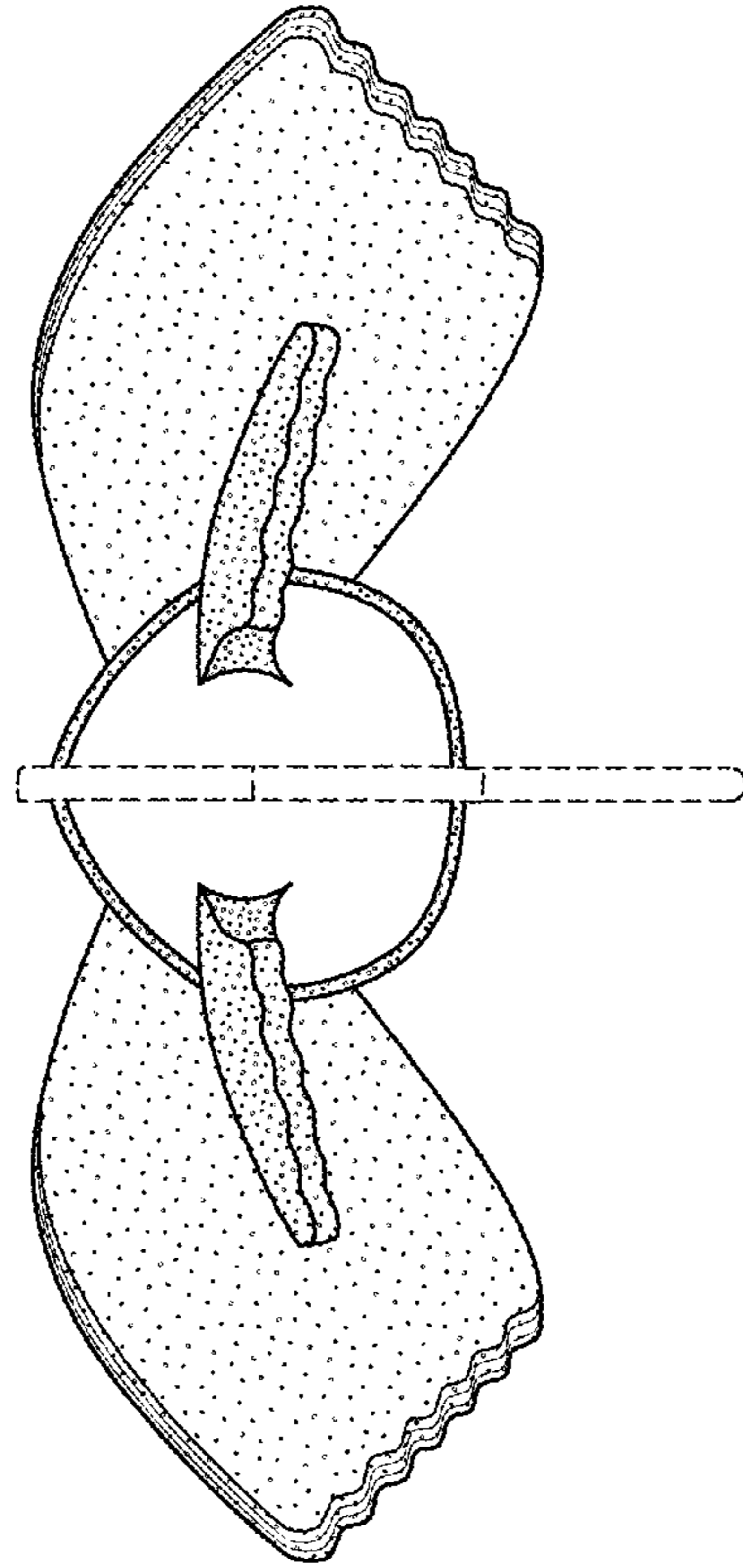

FIG. 14

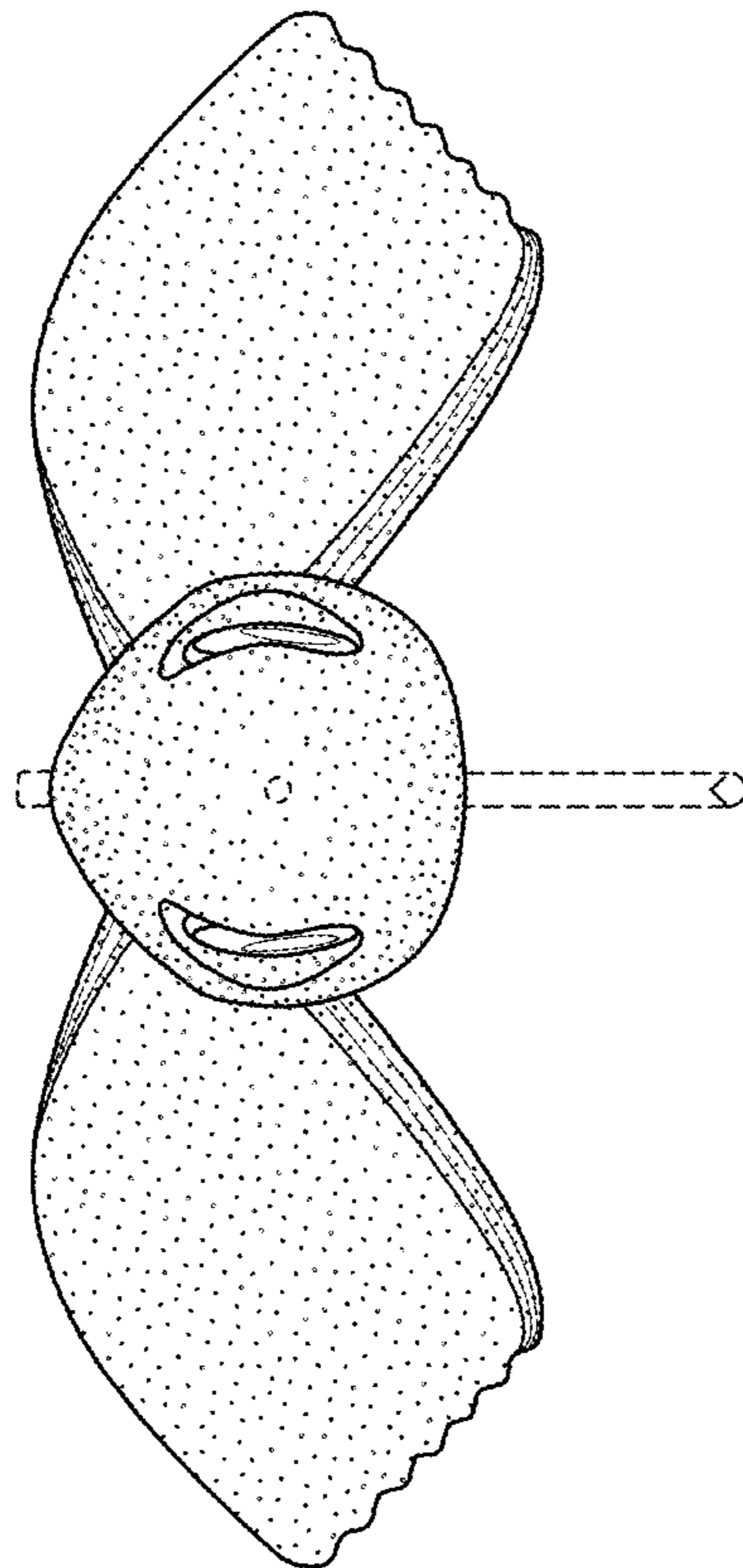

FIG. 13

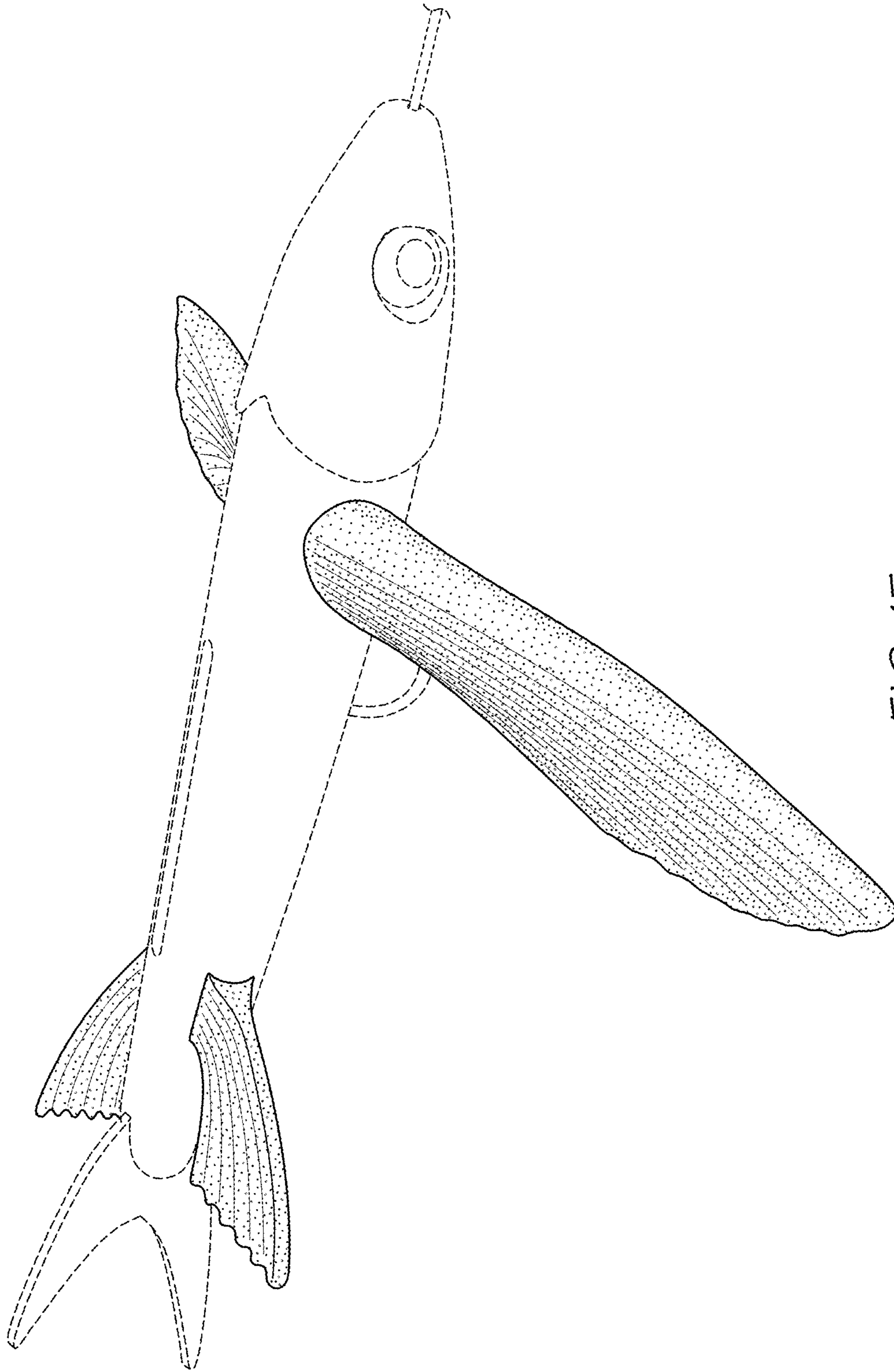

FIG. 15

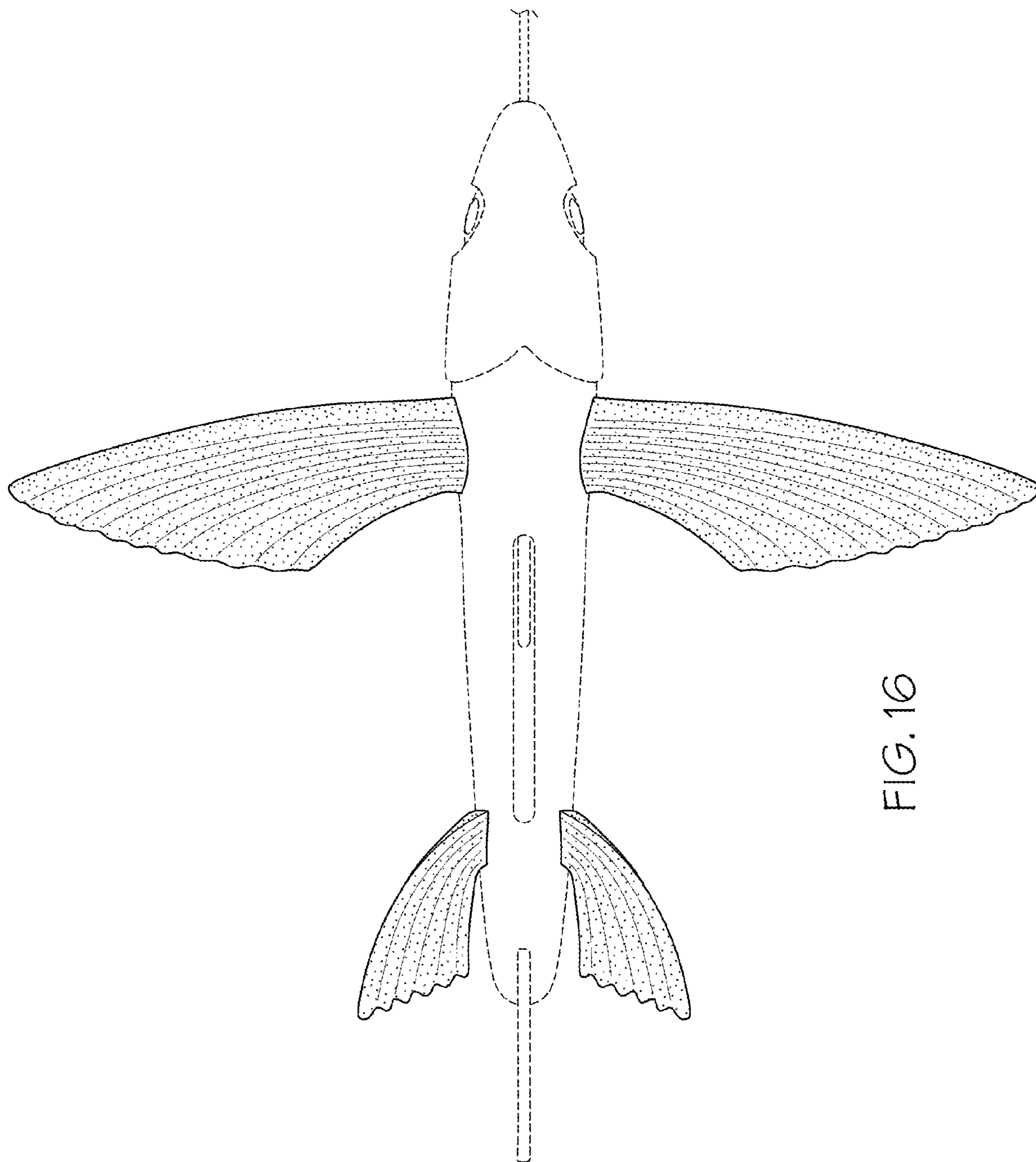

FIG. 16

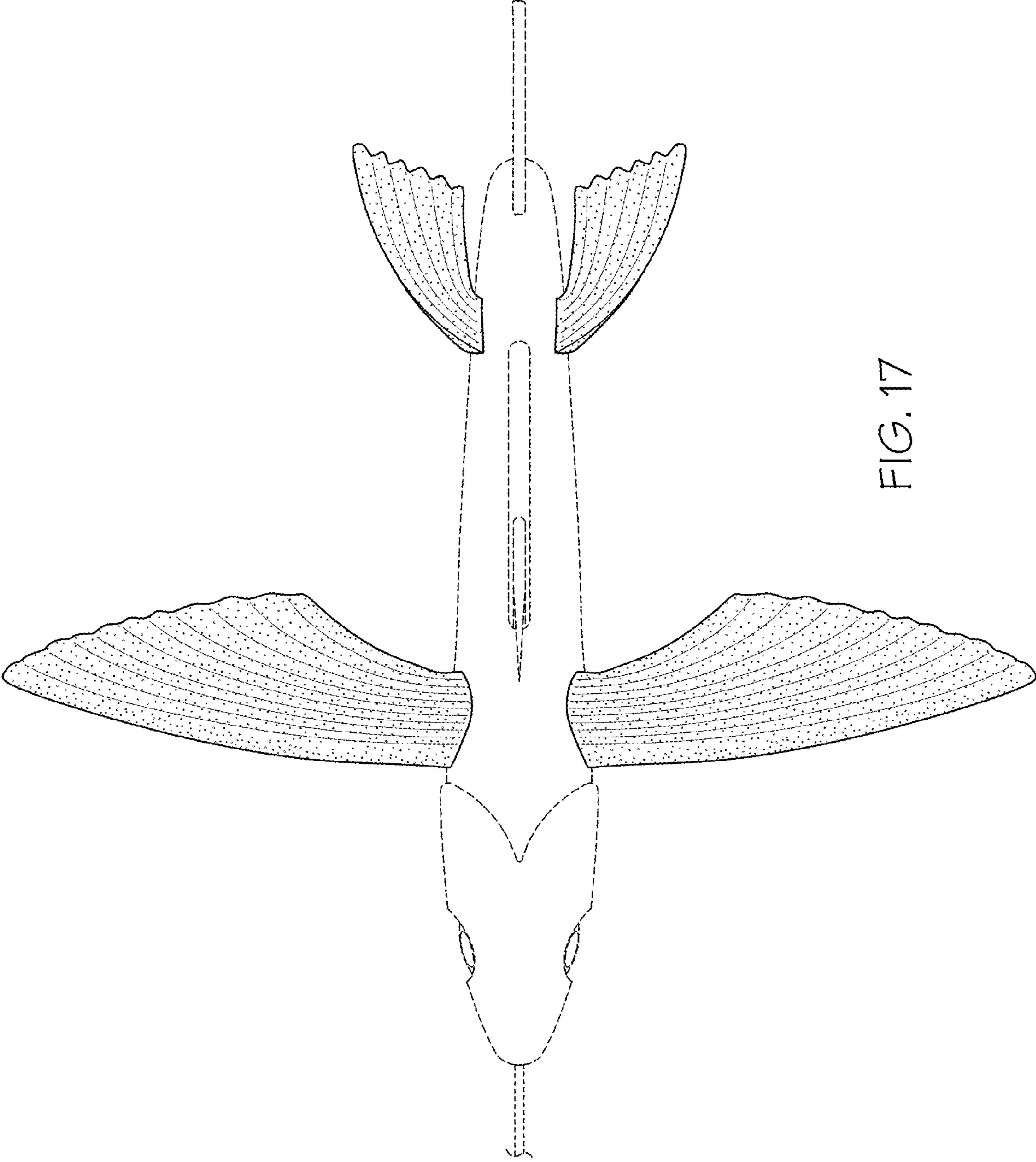

FIG. 17

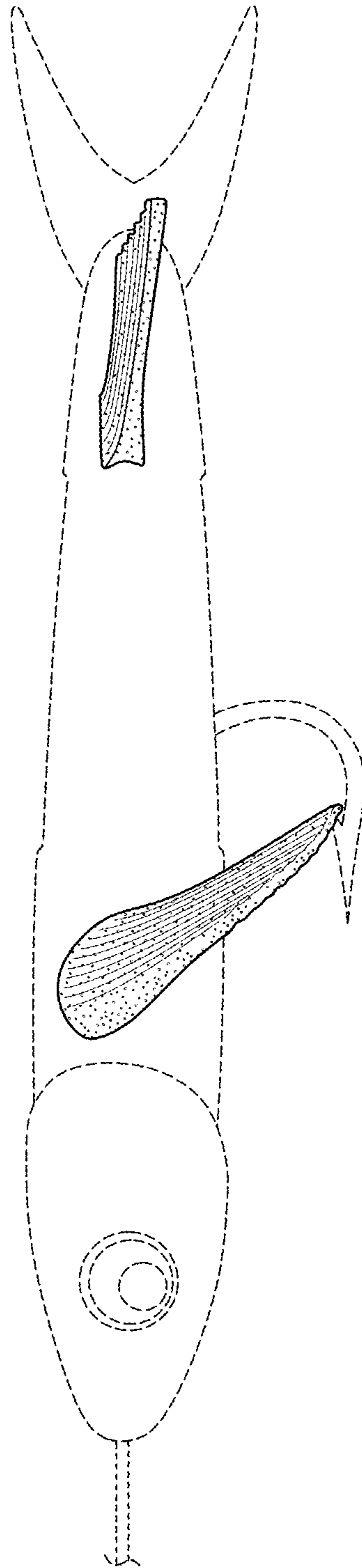

FIG. 18

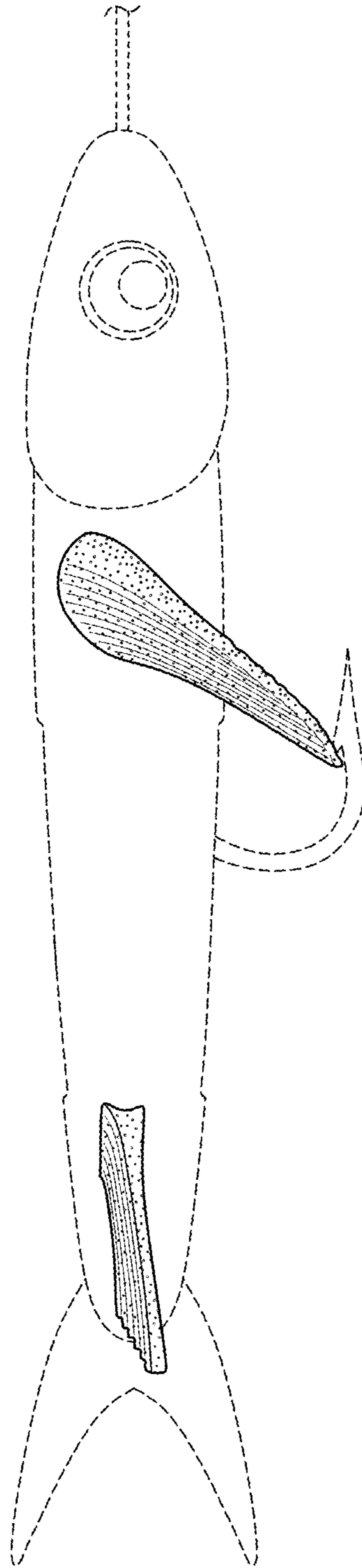

FIG. 19

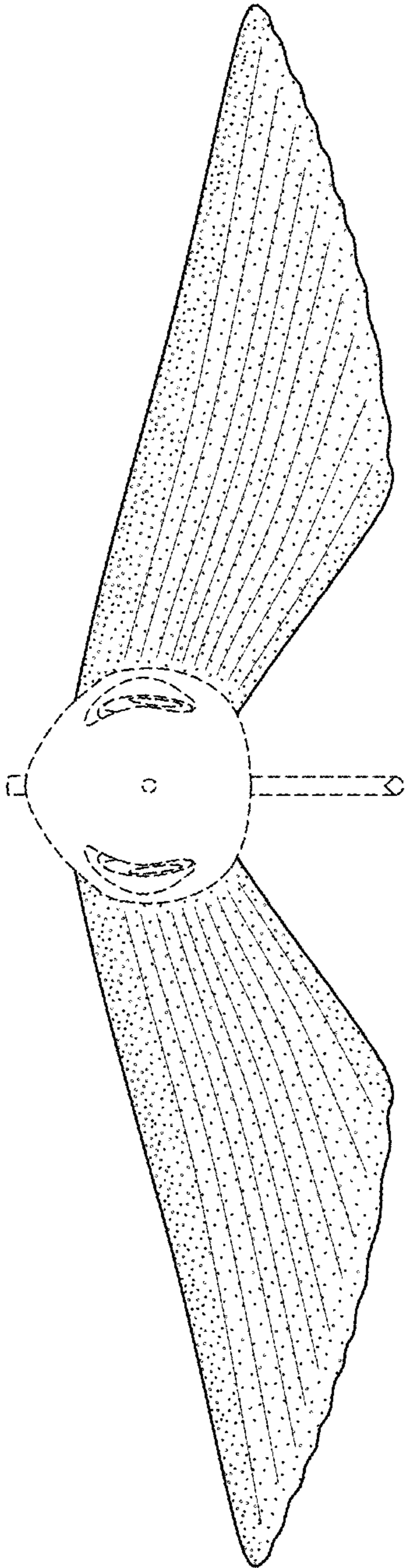

FIG. 20

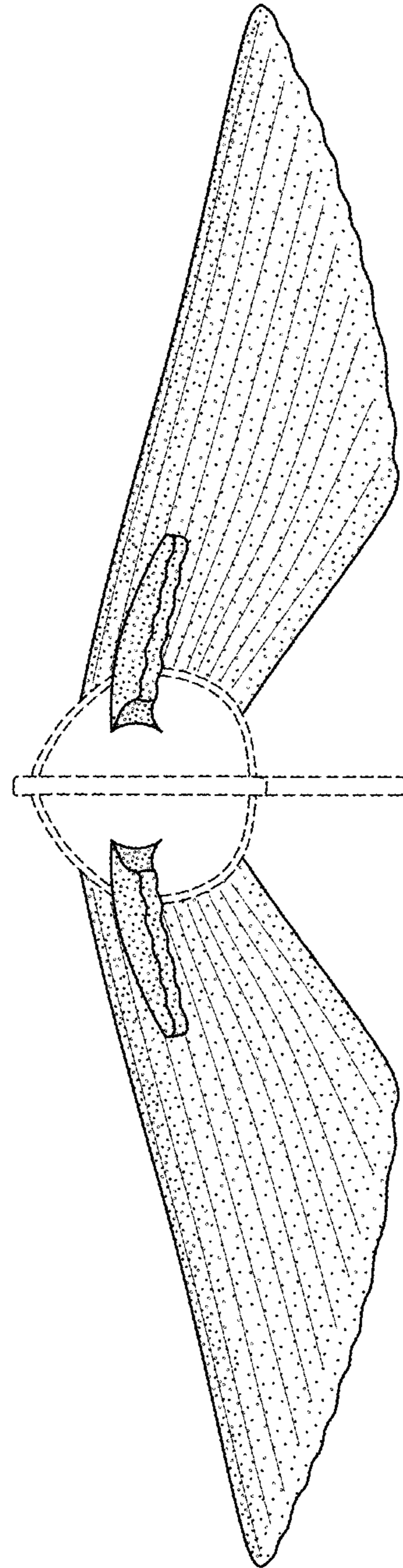

FIG. 21

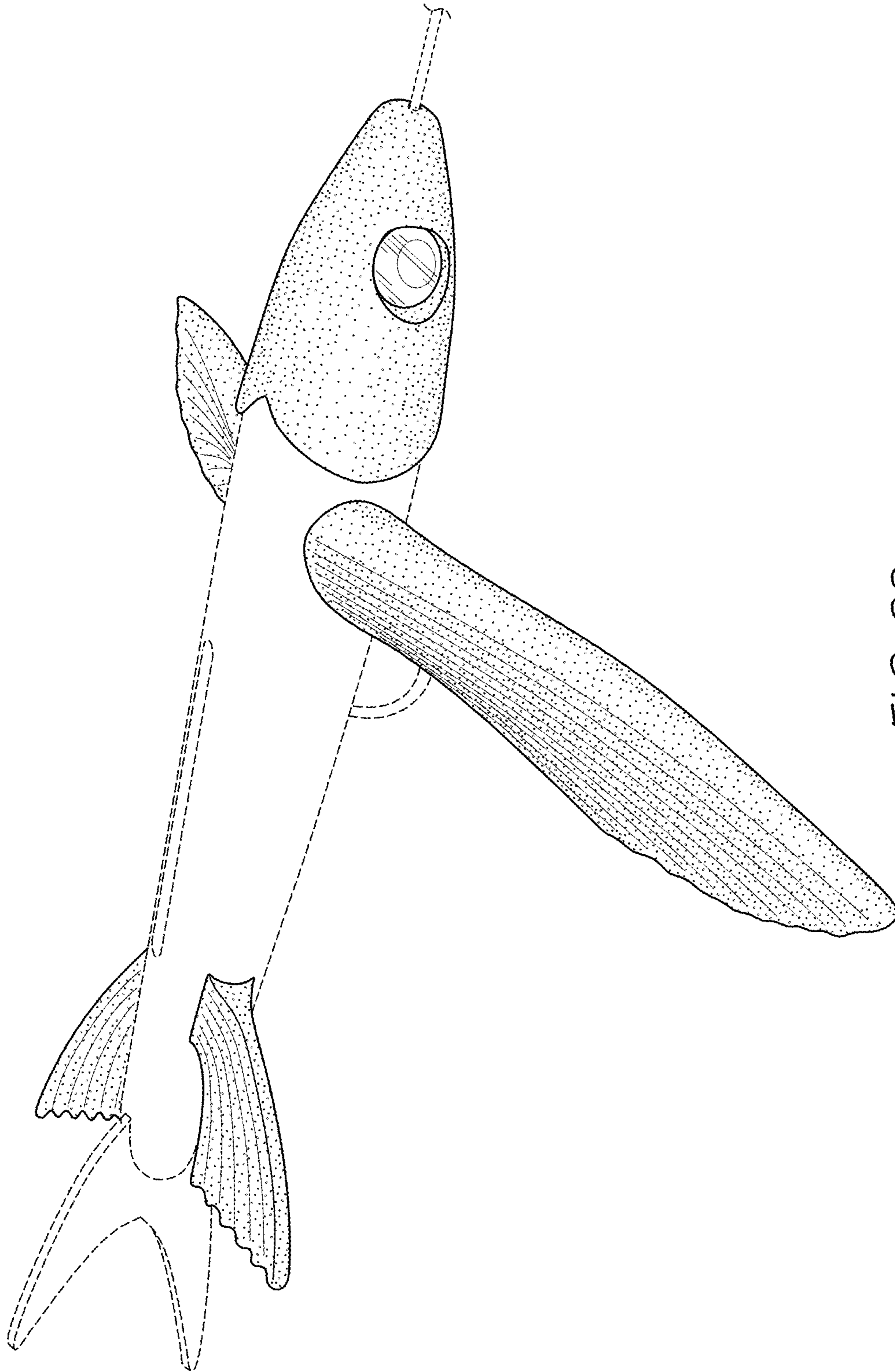

FIG. 22

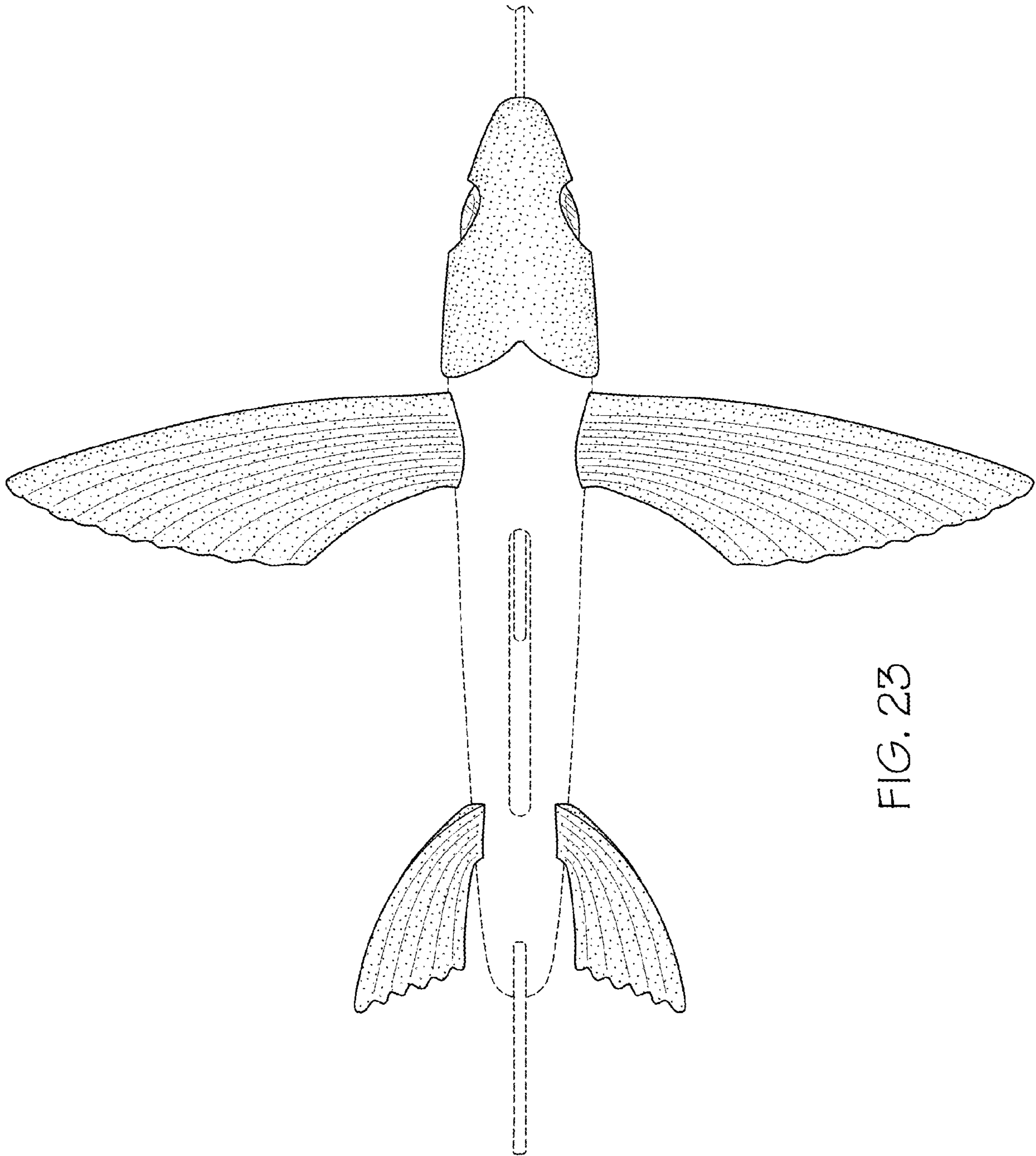

FIG. 23

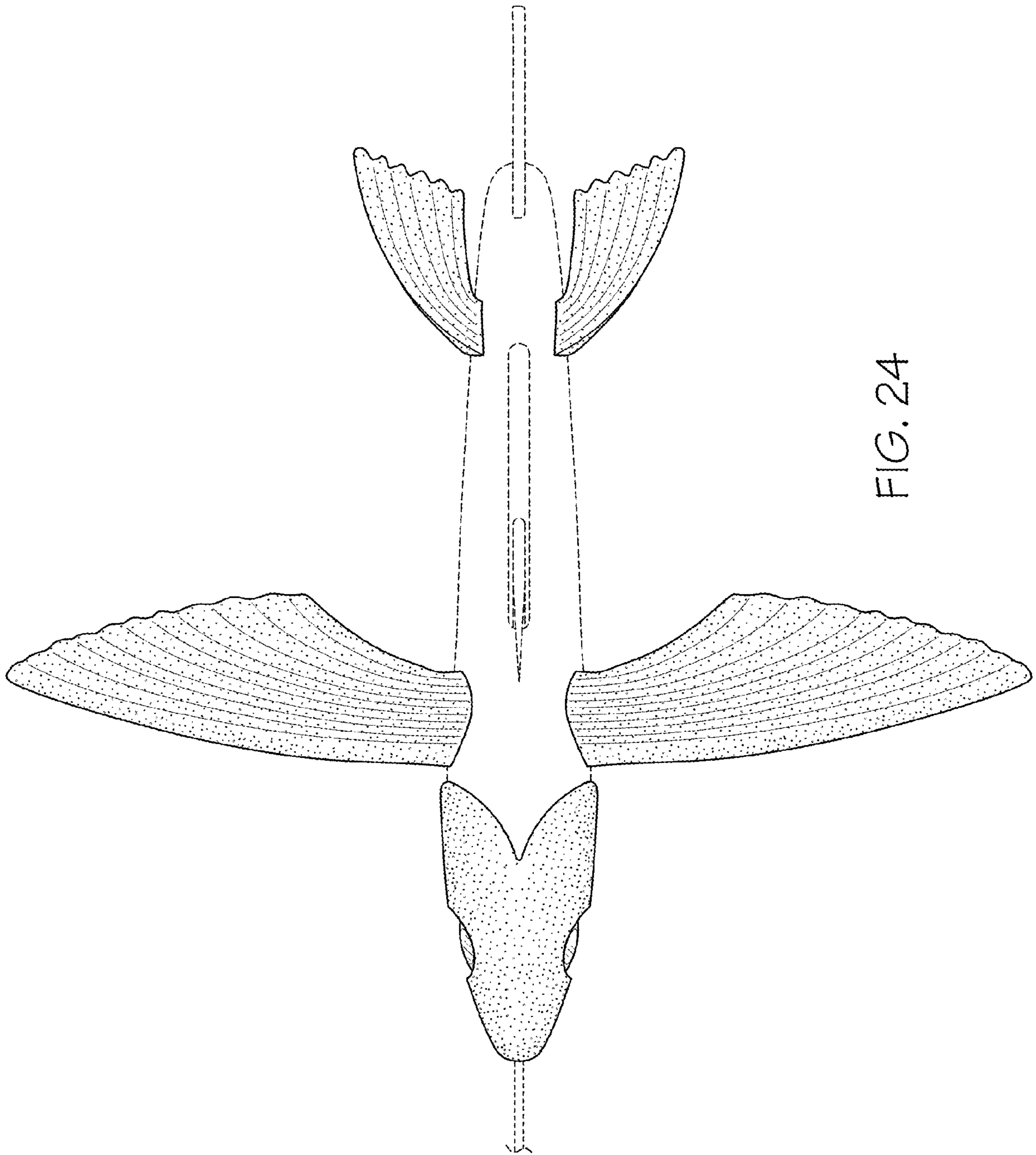

FIG. 24

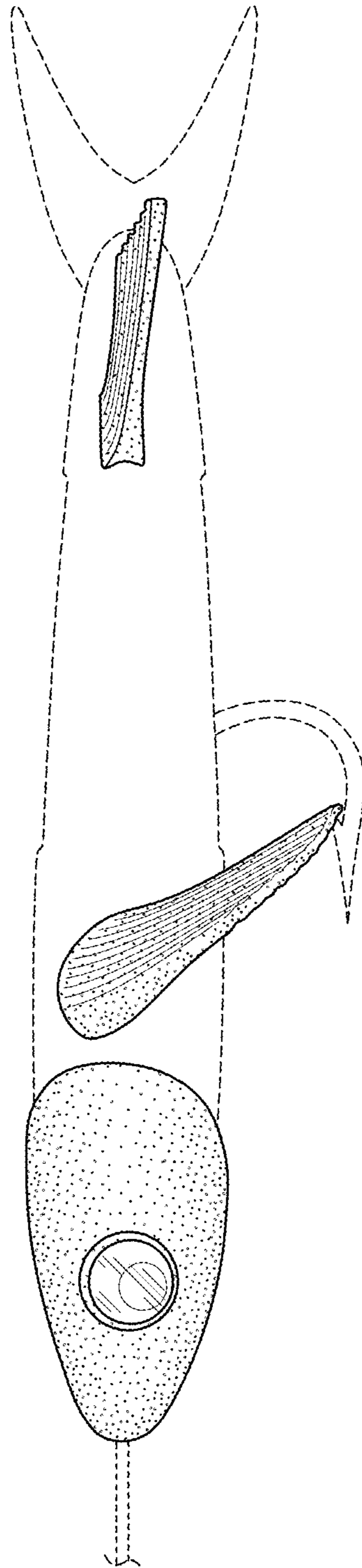

FIG. 25

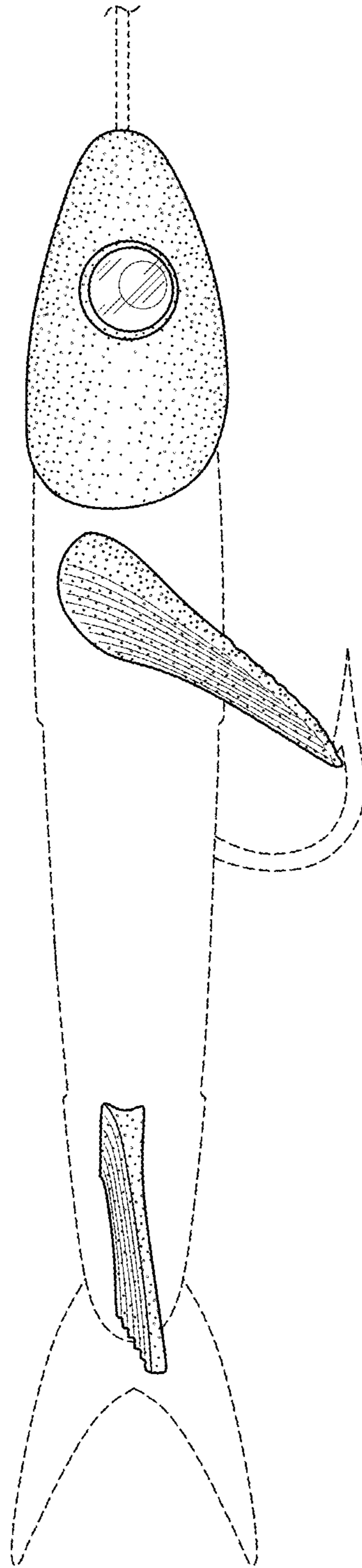

FIG. 26

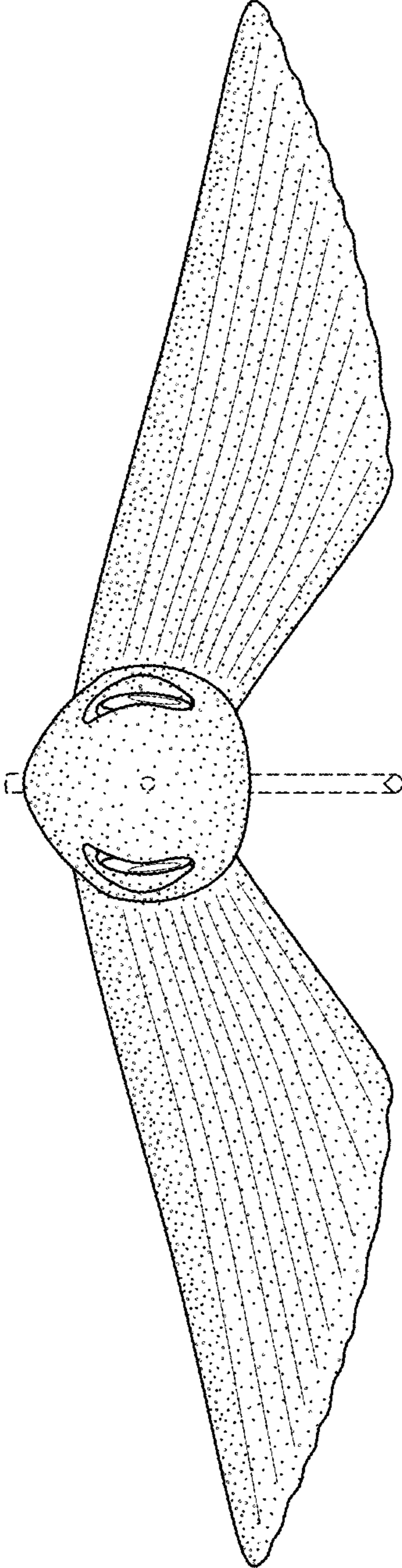

FIG. 27

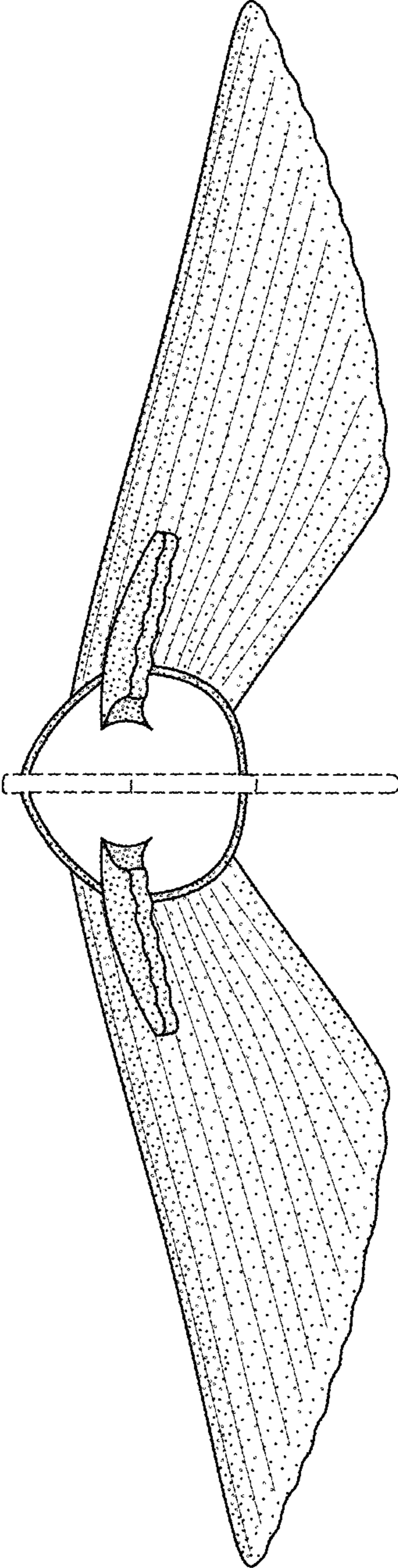

FIG. 28