



US00D881275S

(12) **United States Design Patent**  
**Xie**

(10) **Patent No.:** **US D881,275 S**  
(45) **Date of Patent:** **\*\* Apr. 14, 2020**

- (54) **PEN**
- (71) Applicant: **Beifa Group Co., Ltd., Ningbo (CN)**
- (72) Inventor: **Jianzhe Xie, Ningbo (CN)**
- (73) Assignee: **Beifa Group Co., Ltd., Ningbo (CN)**
- (\*\*) Term: **15 Years**
- (21) Appl. No.: **29/664,609**
- (22) Filed: **Sep. 26, 2018**
- (30) **Foreign Application Priority Data**  
Mar. 26, 2018 (CN) ..... 2018 3 0113040
- (51) **LOC (12) Cl.** ..... **19-06**
- (52) **U.S. Cl.**  
USPC ..... **D19/163**
- (58) **Field of Classification Search**  
USPC ..... D19/115-204; D14/411  
CPC . B43K 5/005; B43K 7/12; B43K 8/04; B43K  
8/06; B43K 19/00; B43K 19/02; B43K  
19/14; B43K 21/006; B43K 21/06  
See application file for complete search history.

- (56) **References Cited**  
U.S. PATENT DOCUMENTS  
D157,471 S \* 2/1950 Doux ..... D19/163  
D202,395 S \* 9/1965 Lamb ..... D19/180  
D254,315 S \* 2/1980 Carre ..... D19/164  
D260,101 S \* 8/1981 Gomez ..... D19/168  
D261,009 S \* 9/1981 Gomez ..... D19/168  
4,308,879 A \* 1/1982 Thornbloom ..... A45D 40/18  
132/317  
D263,482 S \* 3/1982 Carre ..... D19/168  
D377,193 S \* 1/1997 Takemura ..... D19/135  
5,676,480 A \* 10/1997 Tosto ..... A45D 19/02  
132/108

- 6,200,046 B1 \* 3/2001 Rylander ..... B43K 23/08  
401/195
- D475,086 S \* 5/2003 Kent ..... D19/172
- 6,648,536 B1 \* 11/2003 Bellue ..... B43K 19/02  
16/430
- D545,898 S \* 7/2007 Iwasaki ..... D19/163
- D611,988 S \* 3/2010 Huff ..... D19/170
- D633,560 S \* 3/2011 Clivio ..... D19/167
- D637,230 S \* 5/2011 Renner ..... D19/186
- D647,961 S \* 11/2011 Zhang ..... D19/166
- D669,127 S \* 10/2012 Chen ..... D19/169
- D671,168 S \* 11/2012 Renner ..... D19/186
- D682,936 S \* 5/2013 Larson ..... D19/169
- D685,849 S \* 7/2013 Hern ..... D19/174
- D685,850 S \* 7/2013 Hern ..... D19/168
- D697,916 S \* 1/2014 Dowd ..... D14/411
- D723,557 S \* 3/2015 Dowd ..... D14/411
- D729,874 S \* 5/2015 Larson ..... D19/169
- D732,111 S \* 6/2015 Li ..... D19/164
- D774,139 S \* 12/2016 Newson ..... D19/164
- D802,592 S \* 11/2017 Varghese ..... D14/411

(Continued)

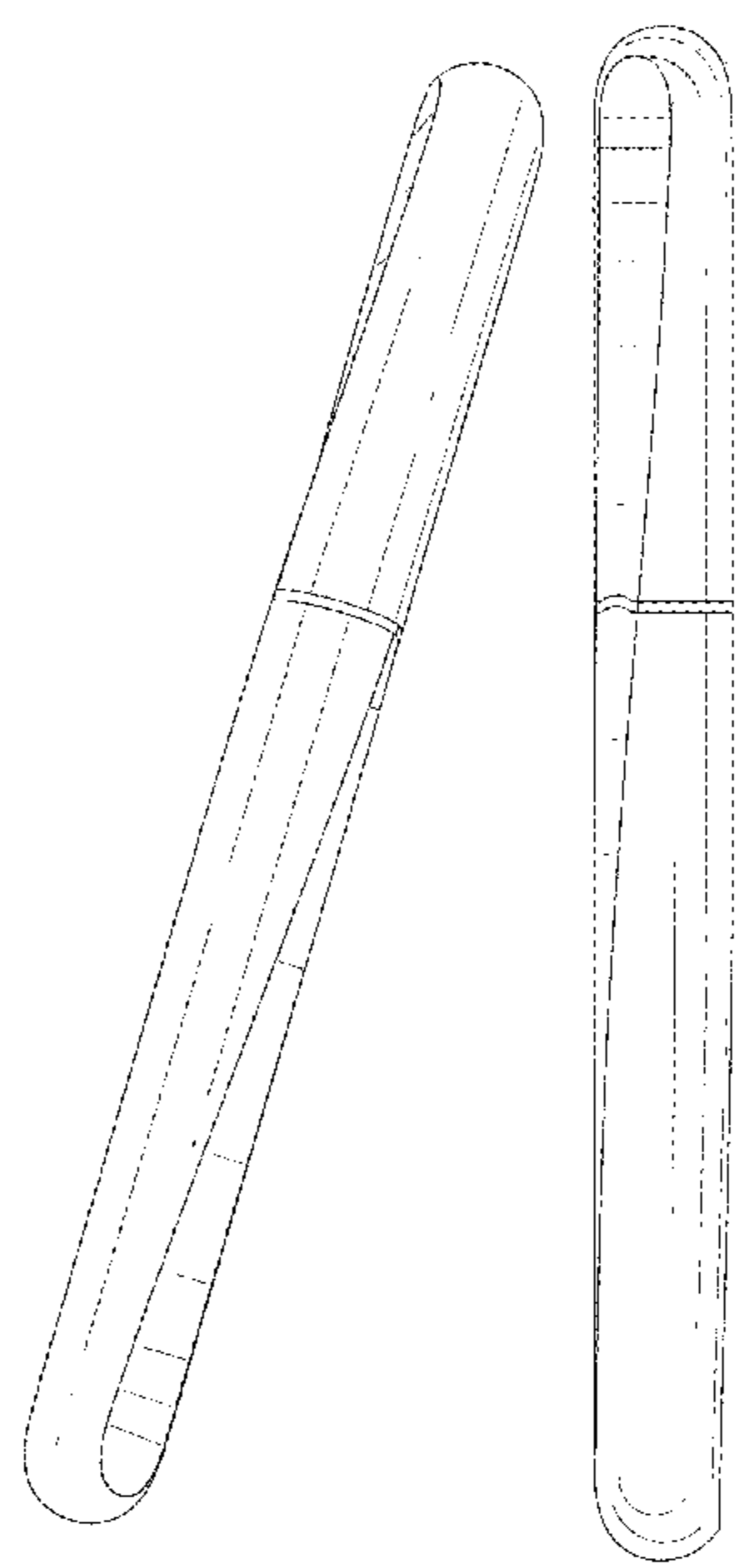
*Primary Examiner* — Elizabeth A. Albert  
(74) *Attorney, Agent, or Firm* — Seed Intellectual  
Property Law Group LLP

(57) **CLAIM**  
The ornamental design for a pen, as shown and described.

**DESCRIPTION**

FIG. 1 is a front right perspective view of a pen showing my new design.  
FIG. 2 is a rear elevation view thereof.  
FIG. 3 is a front elevation view thereof.  
FIG. 4 is a right side elevation view thereof.  
FIG. 5 is a left side elevation view thereof.  
FIG. 6 is a top plan view thereof.  
FIG. 7 is a bottom plan view thereof.  
FIG. 8 is an enlarged top plan view thereof; and,  
FIG. 9 is an enlarged bottom plan view thereof.

**1 Claim, 4 Drawing Sheets**



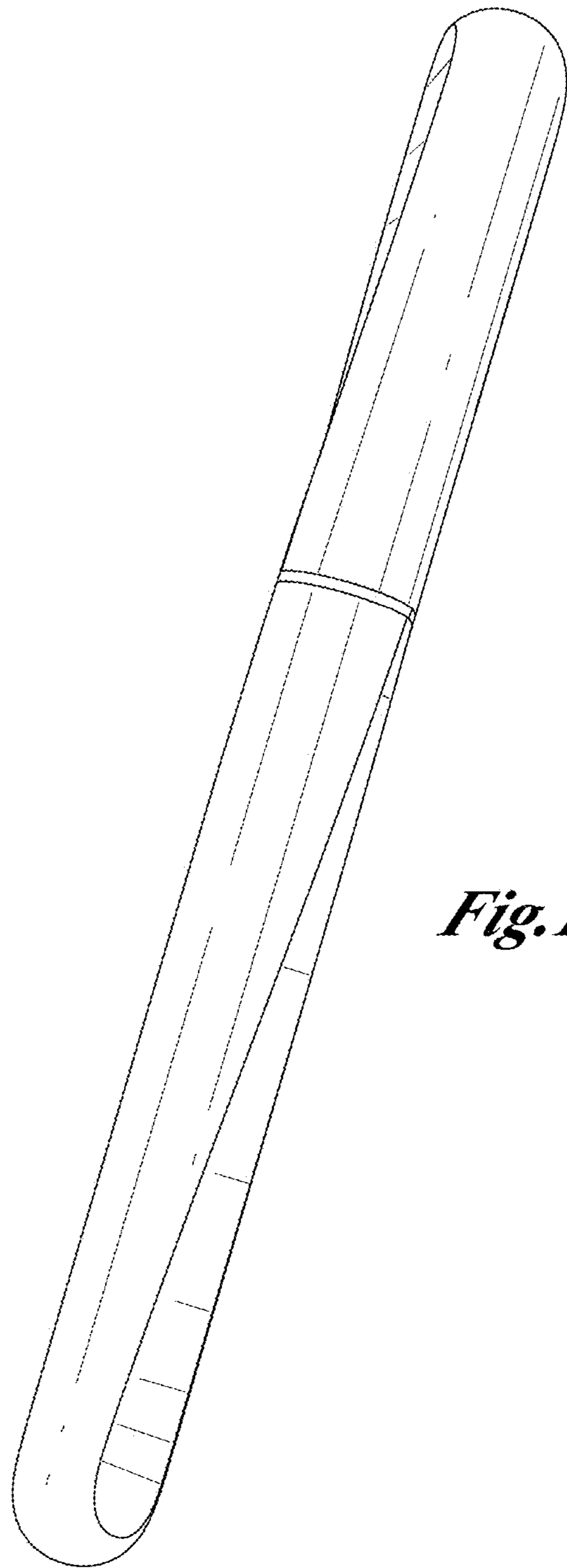
(56)

**References Cited**

U.S. PATENT DOCUMENTS

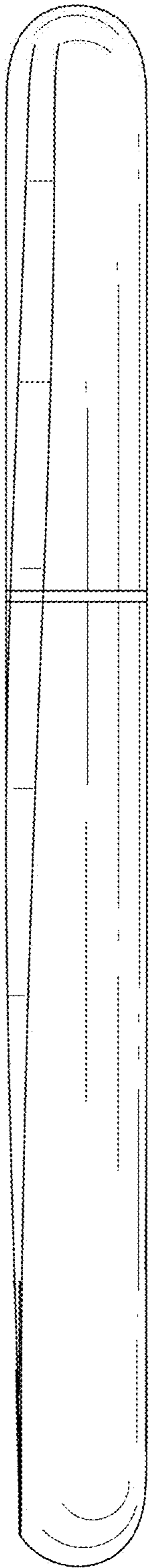
D819,130	S	*	5/2018	Van Den Broecke .....	D19/169
D819,738	S	*	6/2018	Kevin .....	D19/163
D825,662	S	*	8/2018	Van Den Broecke .....	D19/169
D829,820	S	*	10/2018	Bohrer .....	D19/163
D841,806	S	*	2/2019	Leather .....	D24/135

\* cited by examiner

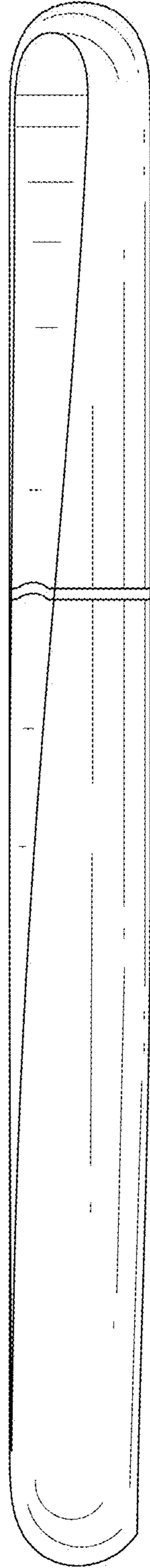


*Fig. 1.*

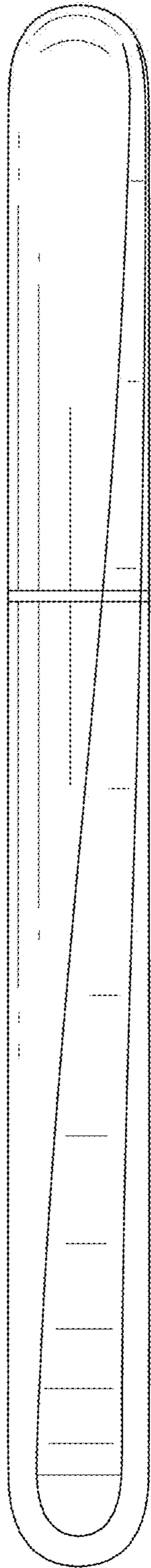
*Fig. 2.*



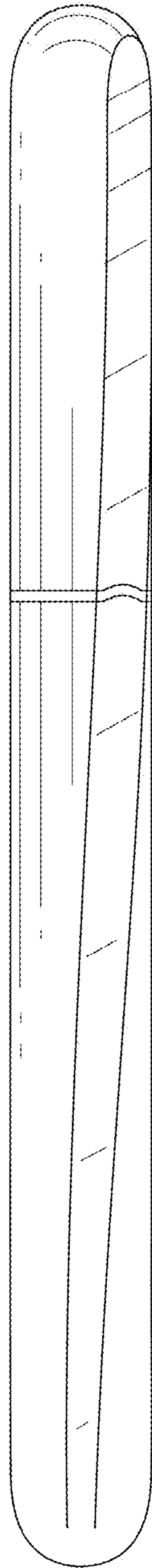
*Fig. 3.*

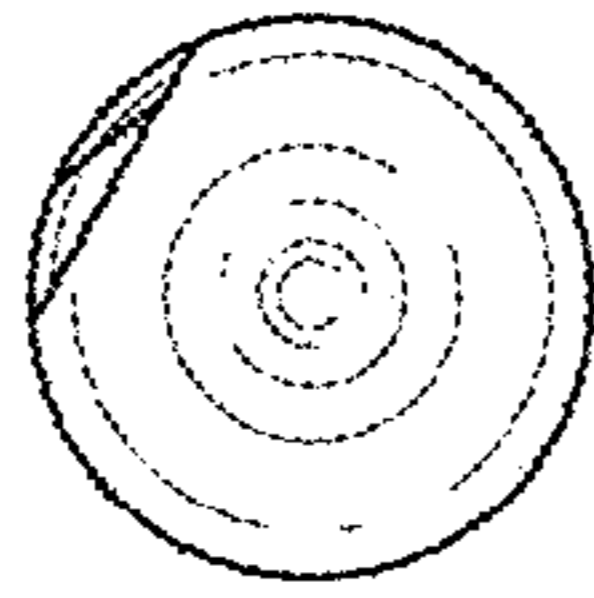


*Fig. 4.*

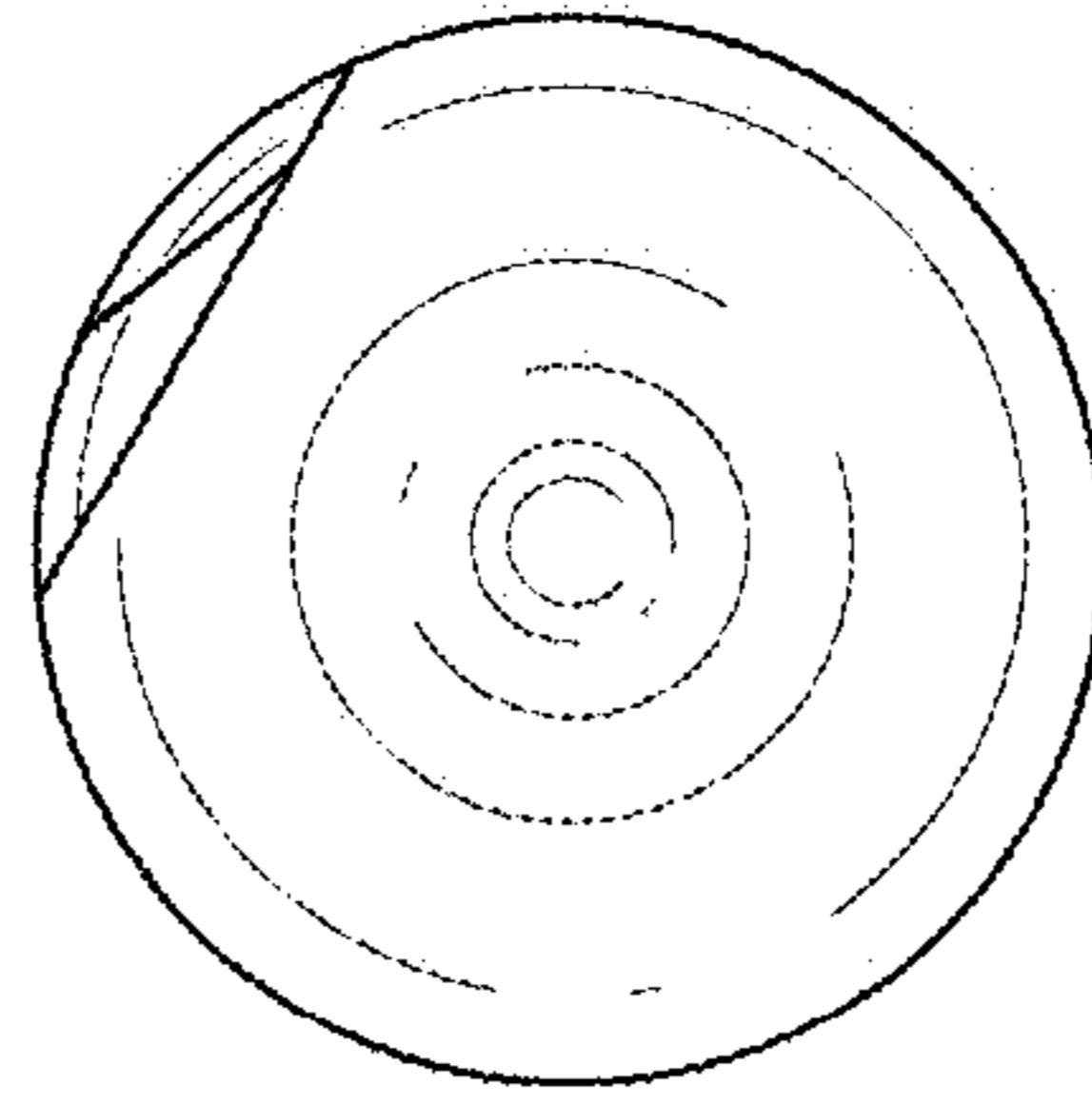


*Fig. 5.*

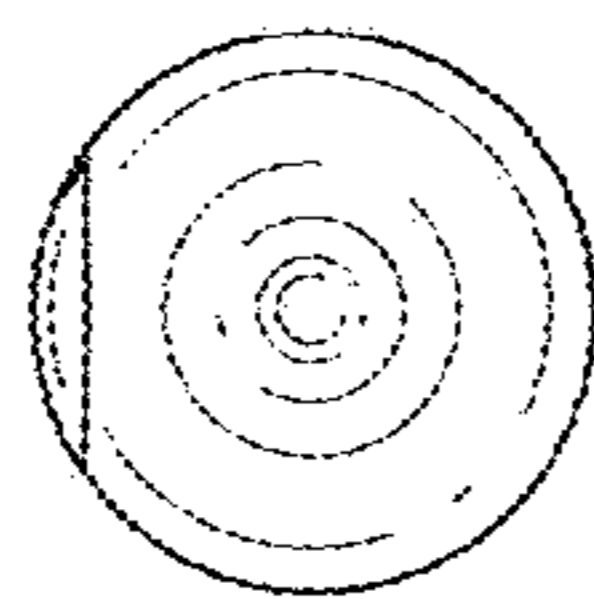




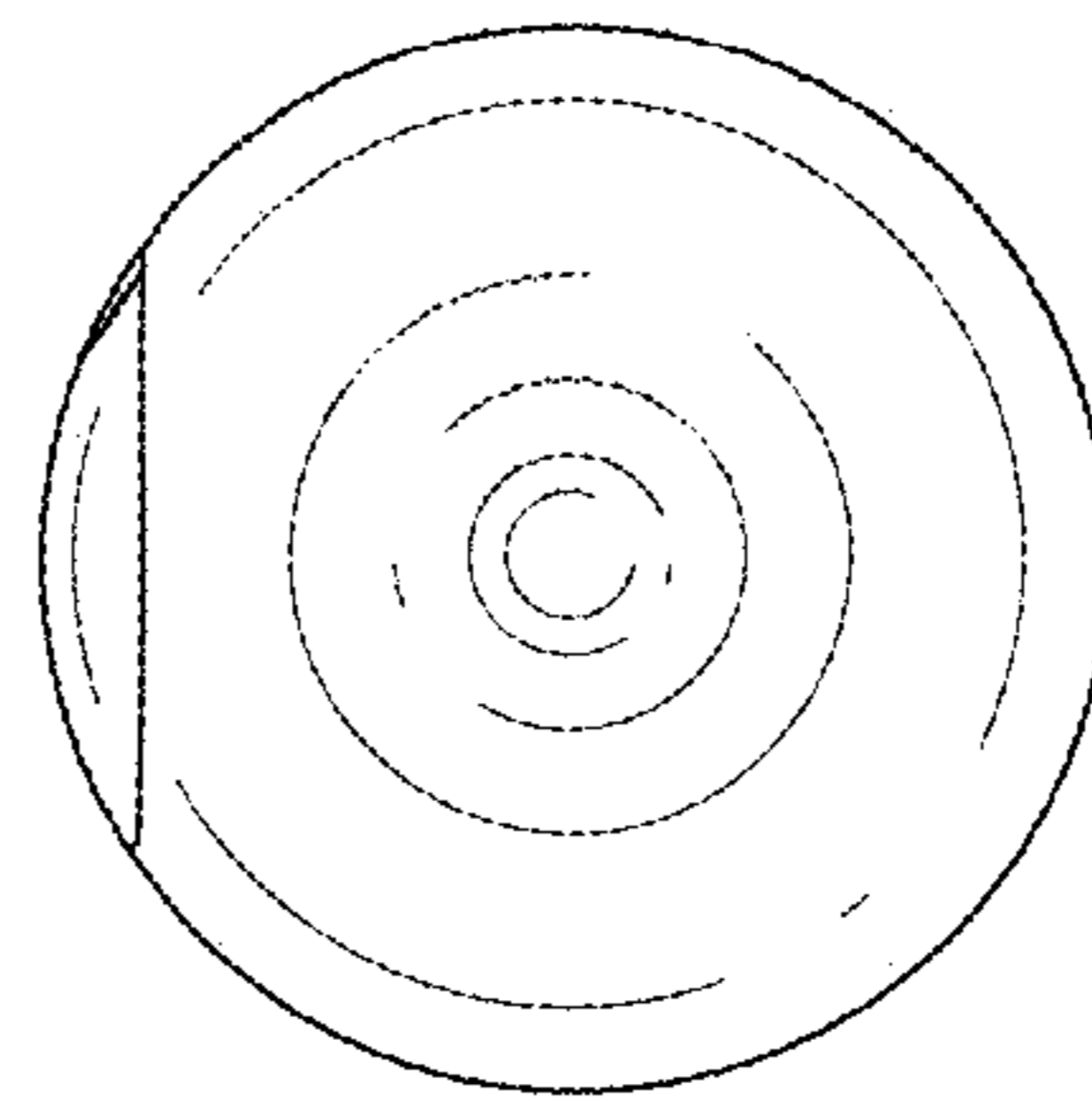
*Fig. 6.*



*Fig. 8.*



*Fig. 7.*



*Fig. 9.*