



US00D881274S

(12) **United States Design Patent**
Bennett

(10) **Patent No.:** **US D881,274 S**

(45) **Date of Patent:** **** Apr. 14, 2020**

(54) **ART TEMPLATE**

(71) Applicant: **Anna Bennett**, Delhi, CA (US)

(72) Inventor: **Anna Bennett**, Delhi, CA (US)

(**) Term: **15 Years**

(21) Appl. No.: **29/699,902**

(22) Filed: **Jul. 30, 2019**

(51) **LOC (12) Cl.** **19-06**

(52) **U.S. Cl.**
USPC **D19/108**

(58) **Field of Classification Search**
USPC D19/108, 37-40; D10/62, 64; D11/131,
D11/132, 157; D18/15, 16, 19
CPC B43L 13/201; B43L 13/203; B43L 13/205;
B05C 17/06; B41M 1/12; G09B 11/04
See application file for complete search history.

(56) **References Cited**

U.S. PATENT DOCUMENTS

- 4,049,374 A * 9/1977 Rejto B41F 16/00
8/471
- 4,608,721 A * 9/1986 Lipkin A42B 1/066
2/172
- D291,955 S * 9/1987 Durand D20/11
- 5,151,572 A * 9/1992 Jack B41C 1/145
219/121.69
- D553,187 S * 10/2007 Bradley D19/40
- D593,153 S * 5/2009 Eckardt D19/40

- D625,623 S * 10/2010 Smink D10/64
- D663,769 S * 7/2012 Sward D19/40
- D668,715 S * 10/2012 Lieske D18/56
- 8,413,579 B2 * 4/2013 Ferretti B44D 2/007
101/114
- D820,797 S * 6/2018 O'Connell D13/199
- D826,324 S * 8/2018 Cornett D19/40

* cited by examiner

Primary Examiner — Elizabeth A. Albert

(74) *Attorney, Agent, or Firm* — Cramer Patent & Design, PLLC; Aaron R. Cramer

(57) **CLAIM**

The ornamental design for an art template, as shown and described.

DESCRIPTION

FIG. 1 is a perspective top front right view of an art template, showing my new design;
 FIG. 2 is a perspective top rear left view thereof;
 FIG. 3 is a front elevation view thereof, wherein the rear elevation view is an identical image thereof;
 FIG. 4 is a right elevation view thereof, wherein the left elevation view is an identical image thereof;
 FIG. 5 is a top plan view thereof; and,
 FIG. 6 is a bottom plan view thereof.

1 Claim, 6 Drawing Sheets

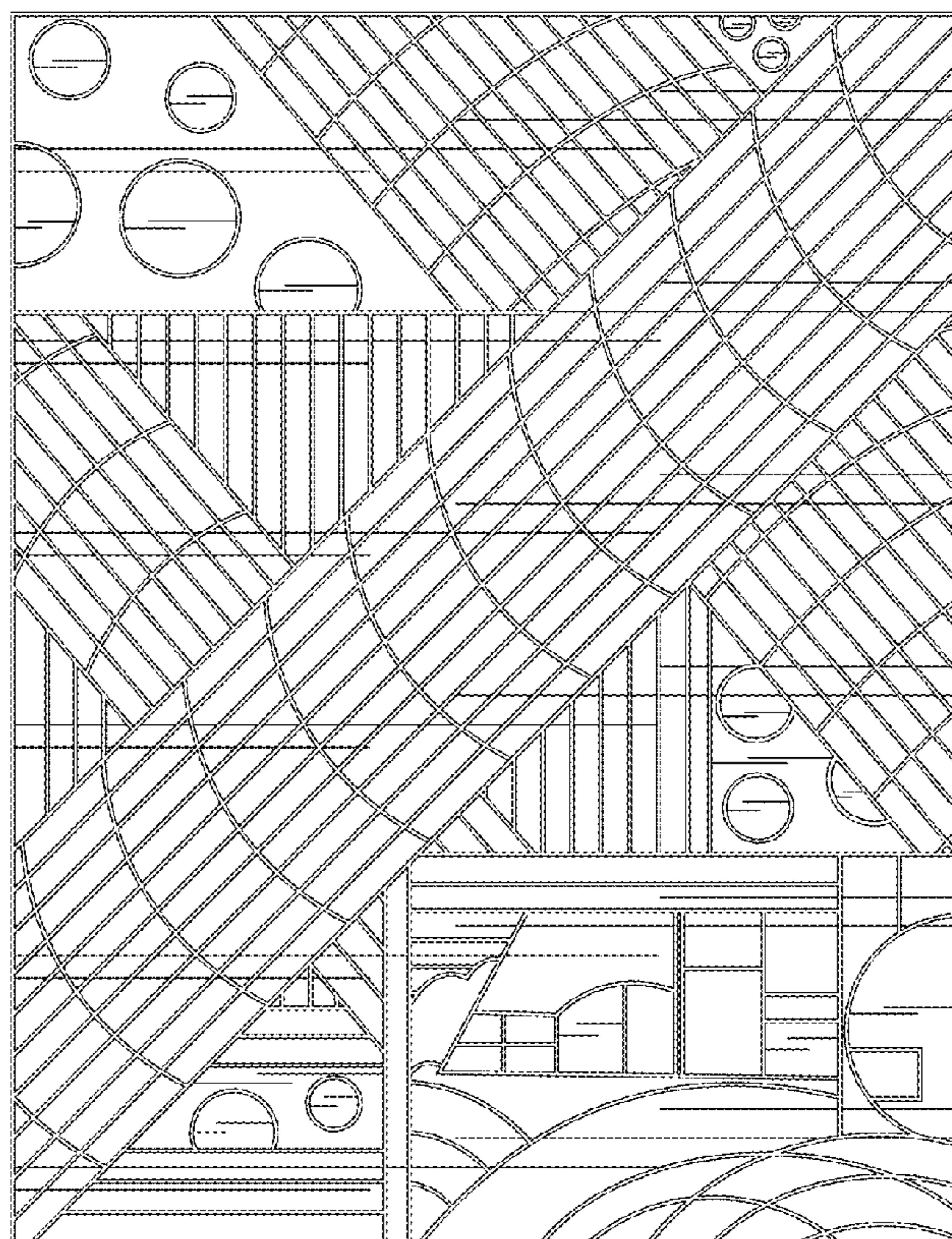
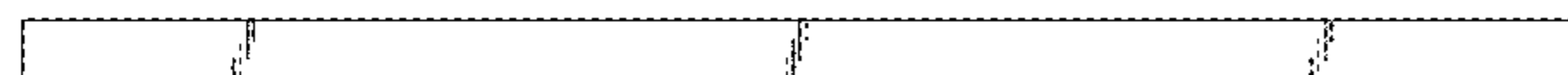

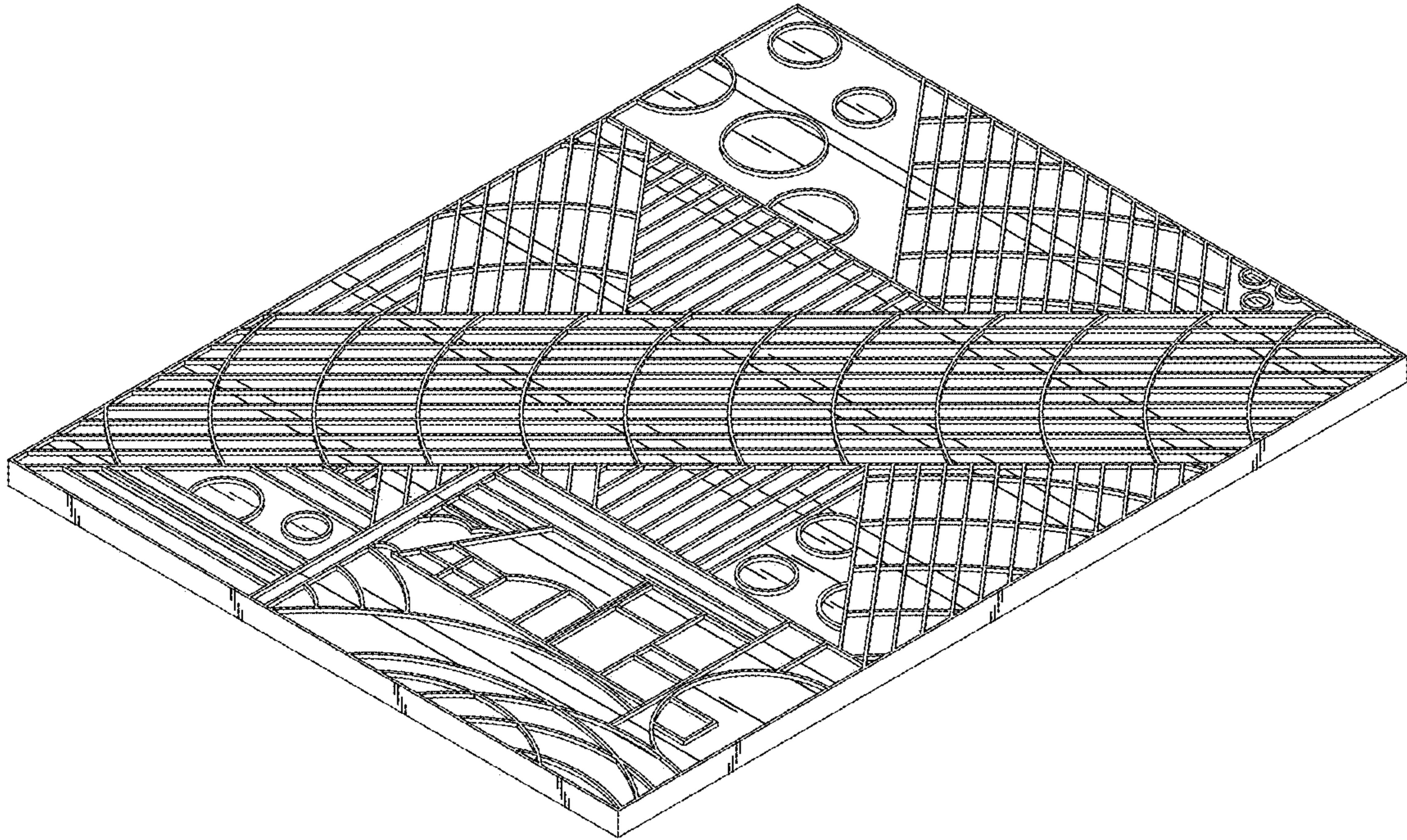

FIG. 1

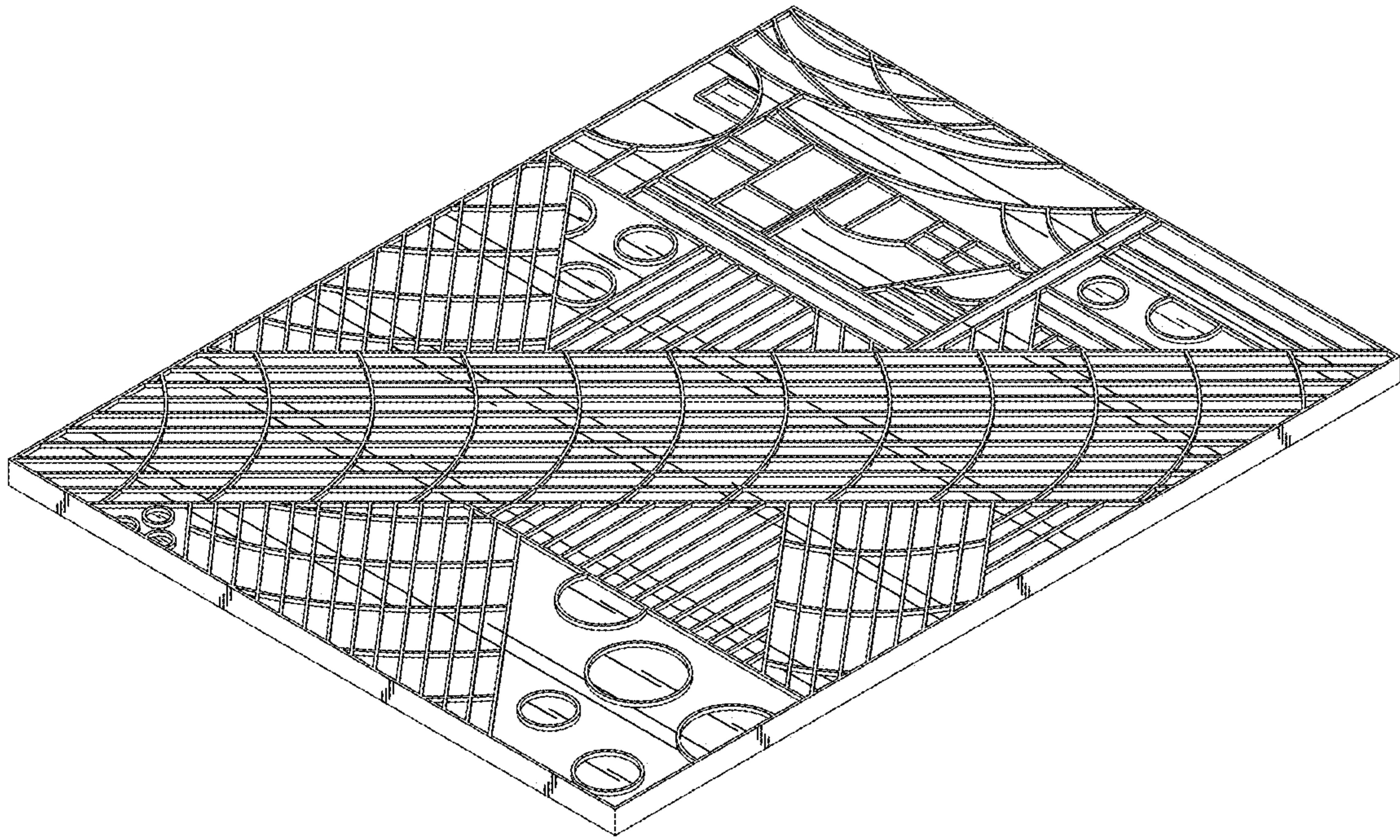

FIG. 2

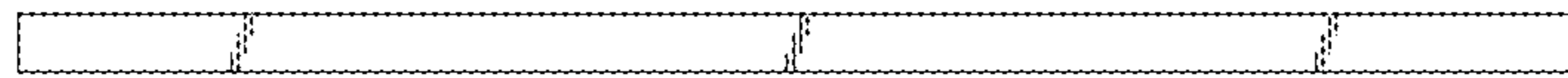

FIG. 3

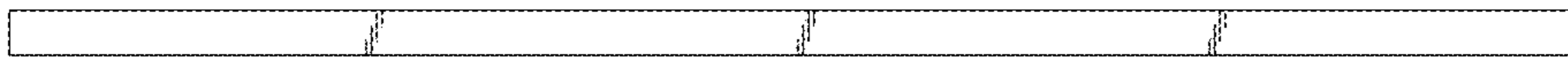

FIG. 4

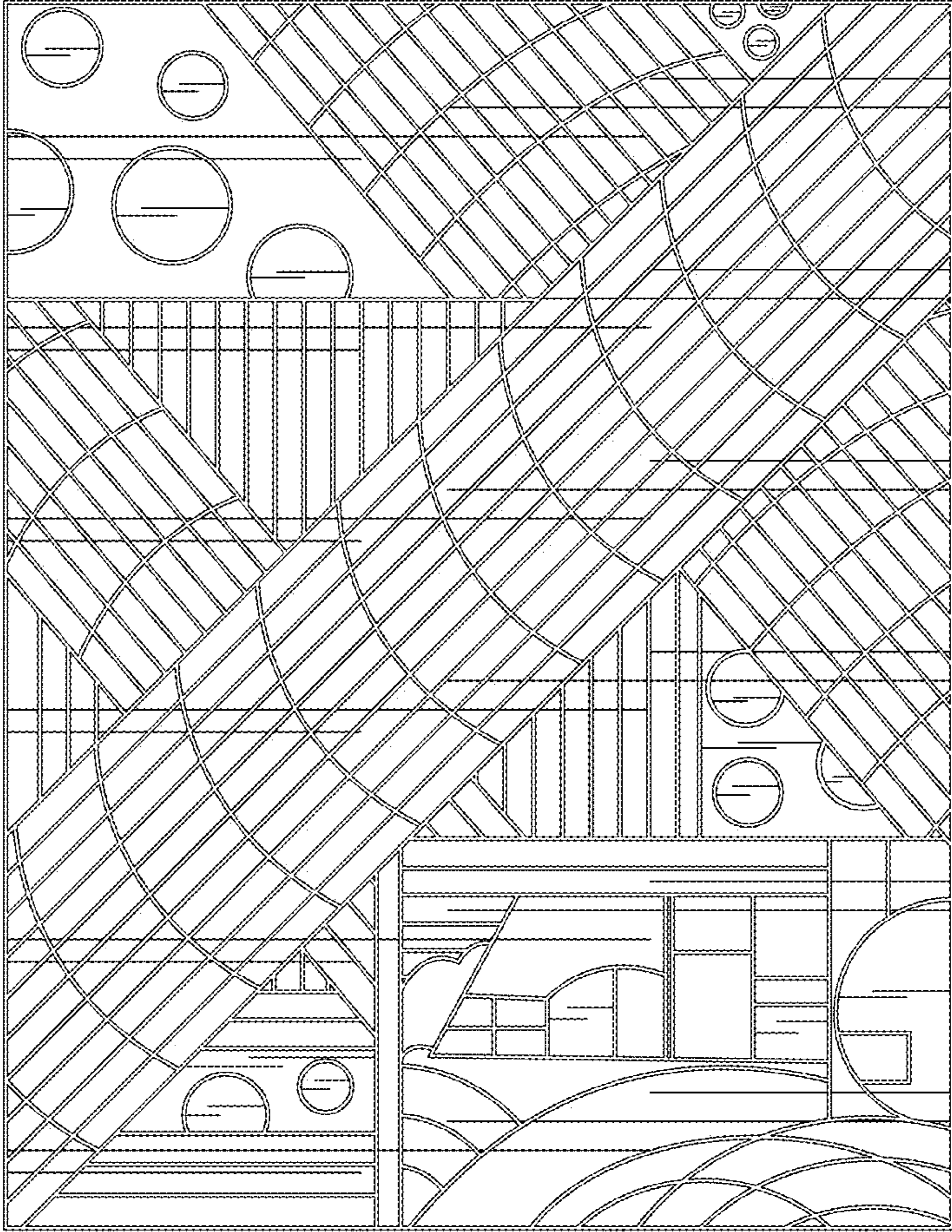

FIG. 5

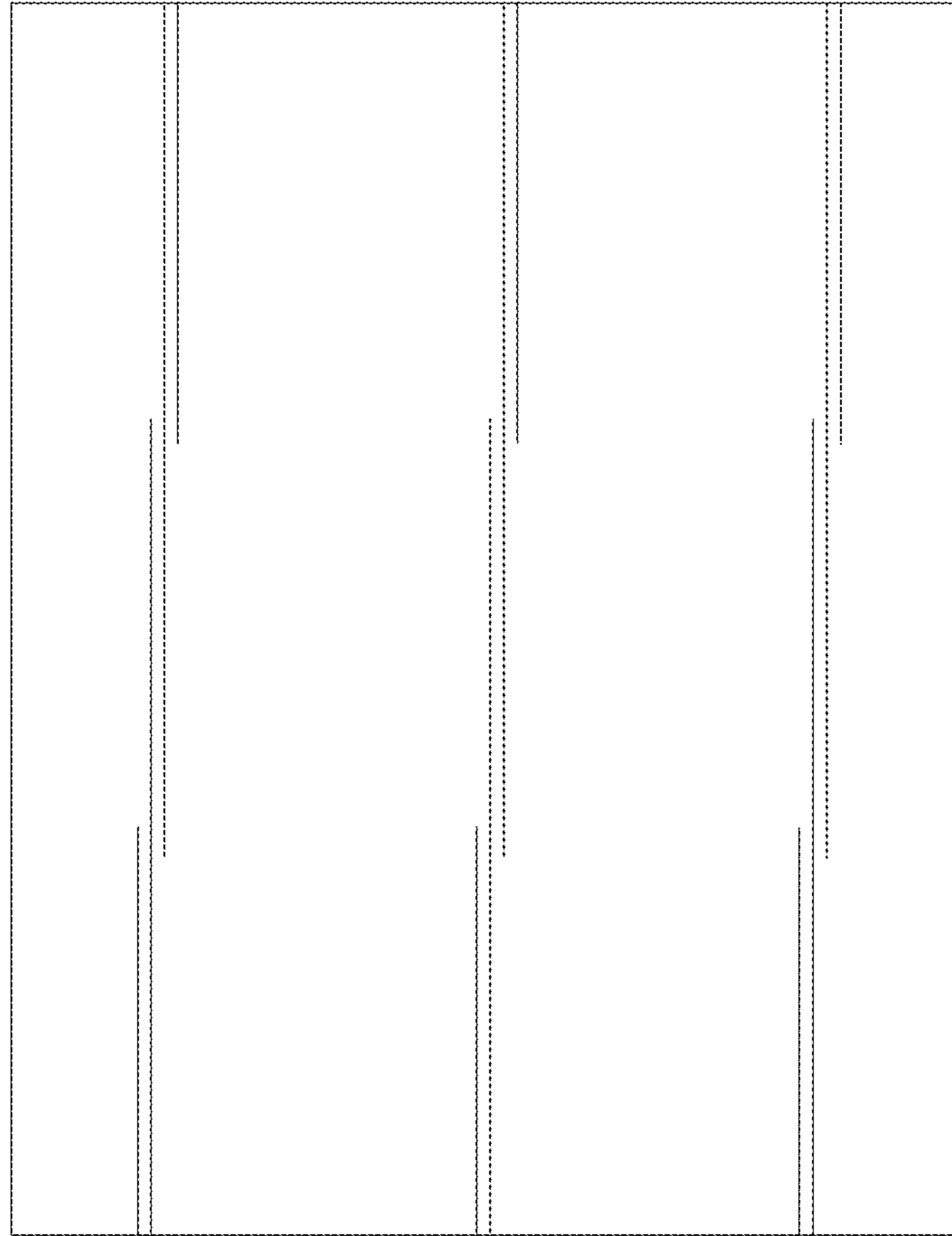

FIG. 6