



US00D881203S

(12) **United States Design Patent** (10) **Patent No.:** **US D881,203 S**
Omata (45) **Date of Patent:** **** Apr. 14, 2020**

(54) **DISPLAY SCREEN FOR DIGITAL CAMERA WITH TRANSITIONAL GRAPHICAL USER INTERFACE**

(71) Applicant: **FUJIFILM Corporation**, Minato-ku, Tokyo (JP)

(72) Inventor: **Takeharu Omata**, Tokyo (JP)

(73) Assignee: **FUJIFILM Corporation**, Minato-ku, Tokyo (JP)

(**) Term: **15 Years**

(21) Appl. No.: **29/605,323**

(22) Filed: **May 25, 2017**

Related U.S. Application Data

(62) Division of application No. 29/517,974, filed on Feb. 19, 2015, now Pat. No. Des. 794,050.

(30) **Foreign Application Priority Data**

Aug. 19, 2014 (JP) 2014-017947
Aug. 19, 2014 (JP) 2014-017948
Aug. 19, 2014 (JP) 2014-017949
Aug. 19, 2014 (JP) 2014-017950

(51) **LOC (12) Cl.** **14-04**

(52) **U.S. Cl.**
USPC **D14/485**

(58) **Field of Classification Search**
USPC D14/485–495
CPC G06F 3/048; G06F 3/0481; G06F 3/0482;
G06F 3/04842; G06F 3/04847; G06F
3/0485; G06F 1/1692; G06F 2203/04806
See application file for complete search history.

(56) **References Cited**

U.S. PATENT DOCUMENTS

5,537,528 A 7/1996 Takahashi
5,548,345 A 8/1996 Brian
D390,214 S 2/1998 Miller
D427,574 S 7/2000 Sawada

(Continued)

OTHER PUBLICATIONS

DCRP Review: Samsung NV7 OPS, posted Mar. 1, 2007, [retrieved Sep. 8, 2016], Retrieved from Internet, <URL: http://www.dcresource.com/reviews/samsung/nv7-review/>.

Primary Examiner — Daniel J Domino

(74) *Attorney, Agent, or Firm* — Sughrue Mion, PLLC

(57) **CLAIM**

The ornamental design for a display screen for digital camera with transitional graphical user interface, as shown and described.

DESCRIPTION

FIG. 1 is a top, rear and left side perspective view of a display screen for digital camera with transitional graphical user interface showing my new design; FIG. 2 is a rear elevational view thereof; FIG. 3 is an enlarged view of the display screen; FIG. 4 is an enlarged view of the display screen, which transitions from the display screen shown in FIG. 3; FIG. 5 is an enlarged view of the display screen in a manner of use; and, FIG. 6 is a rear elevational view of the digital camera in which the same image is displayed on the display screen and within a viewfinder of the camera body. The appearance of image transitions sequentially between the images shown in FIG. 3 and FIG. 4. The process or period in which one image transitions to another image forms no part of the claimed design. The broken line showing of a digital camera illustrates environment. The remainder of the broken lines illustrate portions of display screen for digital camera with graphical user interface. The broken lines form no part of the claimed design.

1 Claim, 6 Drawing Sheets

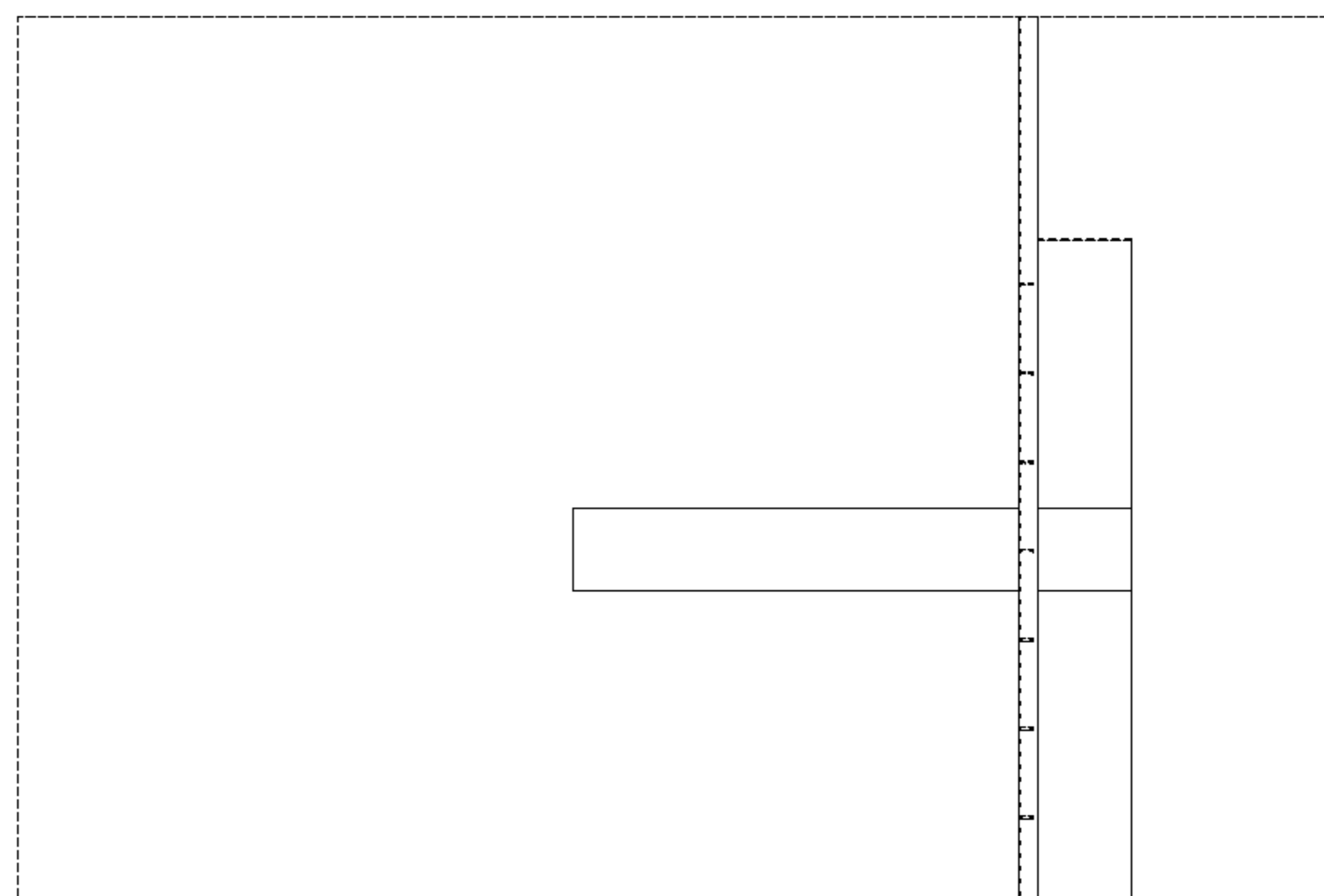
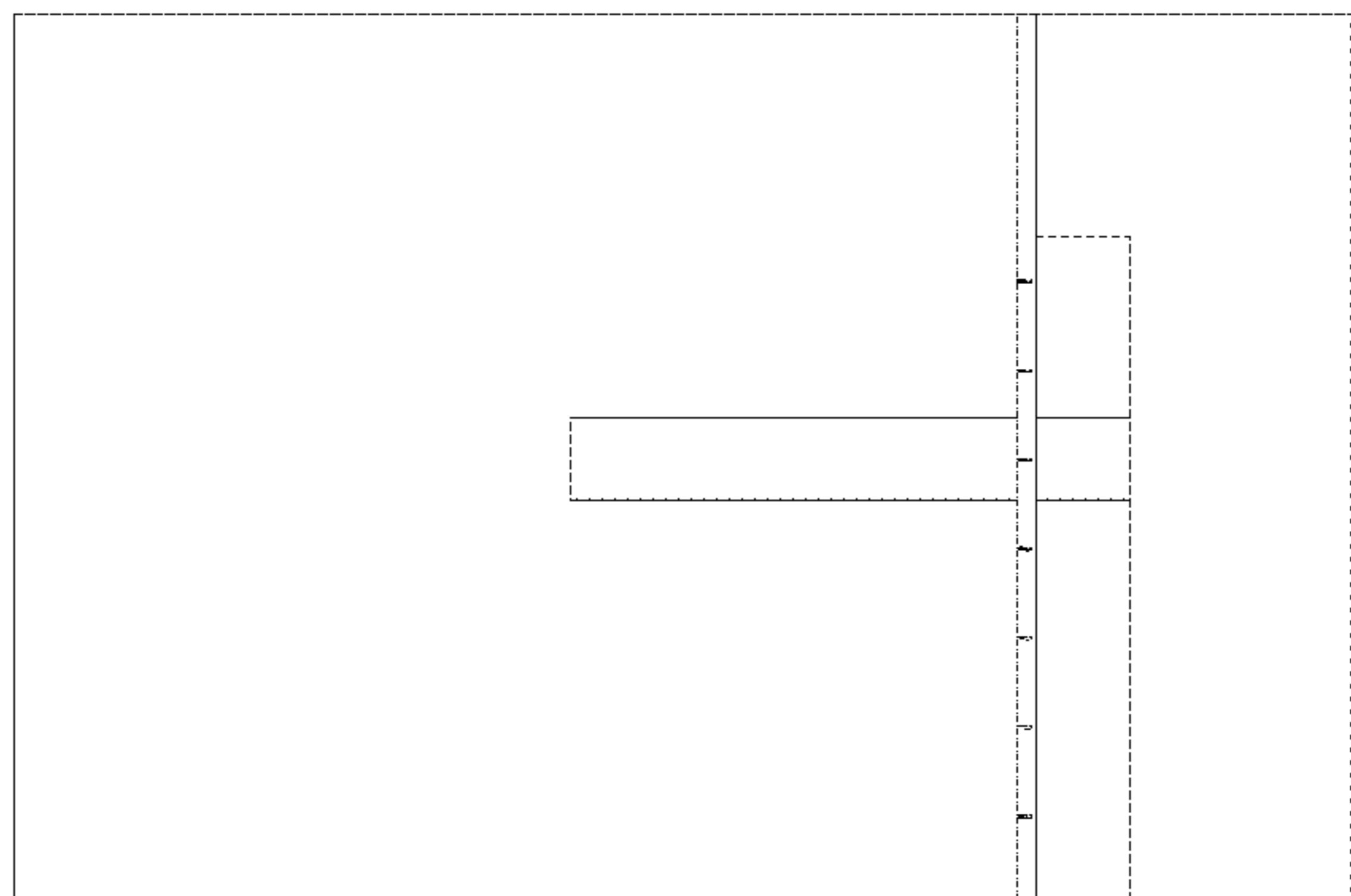

(56)

References Cited

U.S. PATENT DOCUMENTS

D437,601 S 2/2001 Utsuki
 D449,050 S 10/2001 Graham
 D450,324 S * 11/2001 Istvan D14/486
 D450,710 S 11/2001 Yoshioka
 D470,858 S 2/2003 Flamini
 D486,834 S 2/2004 Allen
 6,690,391 B1 2/2004 Proehl
 D499,740 S * 12/2004 Ombao D14/487
 D526,324 S 8/2006 McDougall
 D526,653 S 8/2006 McDougall
 D531,185 S * 10/2006 Cummins D14/485
 D548,241 S * 8/2007 Viegars D14/487
 D548,242 S * 8/2007 Viegars D14/487
 D552,115 S 10/2007 Suzuki
 D554,143 S 10/2007 Keohane
 D557,275 S * 12/2007 De Mar D14/487
 D557,699 S 12/2007 Kim
 D568,333 S * 5/2008 Okaro D14/487
 D592,224 S 5/2009 Blankenship
 D595,309 S * 6/2009 Sasaki D14/488
 D614,196 S * 4/2010 Guntaur D14/486
 D618,250 S * 6/2010 Stallings D14/487
 D629,412 S 12/2010 Chaudhri
 D633,509 S 3/2011 Oda
 D664,562 S * 7/2012 McCain D14/489
 D677,692 S 3/2013 Fong
 D682,854 S * 5/2013 Kanalakakis, Jr. D14/486
 8,553,395 B2 10/2013 Blodorn
 D696,682 S * 12/2013 Kim D14/486
 8,642,364 B2 2/2014 Yagi
 8,653,532 B2 2/2014 Tsuji
 8,736,735 B2 5/2014 Shinohara
 D711,411 S 8/2014 Yu
 8,845,077 B2 9/2014 Kodama
 D716,827 S * 11/2014 Dowd D14/486
 D727,948 S * 4/2015 Milliotte G06F 3/04817
 D727,949 S * 4/2015 Milliotte G06F 3/04817
 D728,594 S * 5/2015 Myette D14/486
 D730,381 S * 5/2015 Zhong D14/487
 D732,057 S * 6/2015 Jeong D14/486
 D732,580 S * 6/2015 Kim D14/493
 D733,181 S * 6/2015 Manfredo D14/488
 D733,745 S * 7/2015 Huang D14/487
 D734,382 S 7/2015 Kim
 D734,773 S * 7/2015 Barbato D14/486
 D736,231 S * 8/2015 Gottschlag D14/486
 D736,232 S * 8/2015 Gottschlag D14/486

D738,941 S 9/2015 Shin
 D740,312 S * 10/2015 Heo D14/487
 D740,835 S * 10/2015 Song D14/485
 D741,879 S * 10/2015 Chapman D14/486
 D741,882 S * 10/2015 Shmilov D14/486
 9,177,980 B2 * 11/2015 Sogoh H01L 27/14609
 9,262,052 B2 * 2/2016 Roulliere G06F 3/0482
 D754,707 S * 4/2016 Zurn D14/486
 D754,713 S * 4/2016 Zhang D14/487
 D755,799 S * 5/2016 Finnis D14/485
 9,357,218 B2 5/2016 Park
 D758,409 S * 6/2016 Aoshima D14/487
 D759,086 S * 6/2016 Aoshima D14/487
 D759,670 S * 6/2016 Lee D14/485
 9,368,539 B2 6/2016 Baba
 D762,731 S 8/2016 Tursi
 D763,792 S 8/2016 Park
 D763,904 S * 8/2016 Knapp D14/488
 D764,523 S 8/2016 Suki
 D765,108 S * 8/2016 Heinrich D14/486
 D770,521 S * 11/2016 Lee D14/488
 D771,679 S * 11/2016 Dzierson D14/486
 D780,799 S * 3/2017 Mehring D14/487
 D784,366 S * 4/2017 Lee D14/485
 D785,035 S * 4/2017 Moroney D14/487
 9,619,108 B2 * 4/2017 Dowd G06F 3/0488
 D793,413 S * 8/2017 Omata D14/486
 D794,050 S * 8/2017 Omata D14/486
 D796,538 S * 9/2017 Yoshida D14/486
 D798,887 S * 10/2017 Sadler D14/486
 D799,505 S * 10/2017 Park D14/485
 D799,537 S * 10/2017 Lalor D14/487
 D800,762 S * 10/2017 Aoshima D14/487
 D803,844 S * 11/2017 Lee D14/485
 D806,097 S * 12/2017 Rahn D14/486
 D806,100 S * 12/2017 Miller D14/486
 D806,731 S * 1/2018 Miller D14/486
 D807,397 S * 1/2018 Heo D14/492
 D820,849 S * 6/2018 Chang D14/485
 D820,864 S * 6/2018 Eder D14/486
 D821,409 S * 6/2018 Chang D14/485
 D821,433 S * 6/2018 Omata D14/486
 D827,666 S * 9/2018 Moroney D14/488
 D834,036 S * 11/2018 Felton D14/485
 D835,116 S * 12/2018 Taylor D14/485
 D835,117 S * 12/2018 Roberts D14/485
 D836,652 S * 12/2018 Fowler D14/486
 D839,883 S * 2/2019 McConnell D14/485
 D840,411 S * 2/2019 Huang D14/485
 D841,046 S * 2/2019 Omata D14/487
 D849,767 S * 5/2019 Mok D14/486

* cited by examiner

FIG. 1

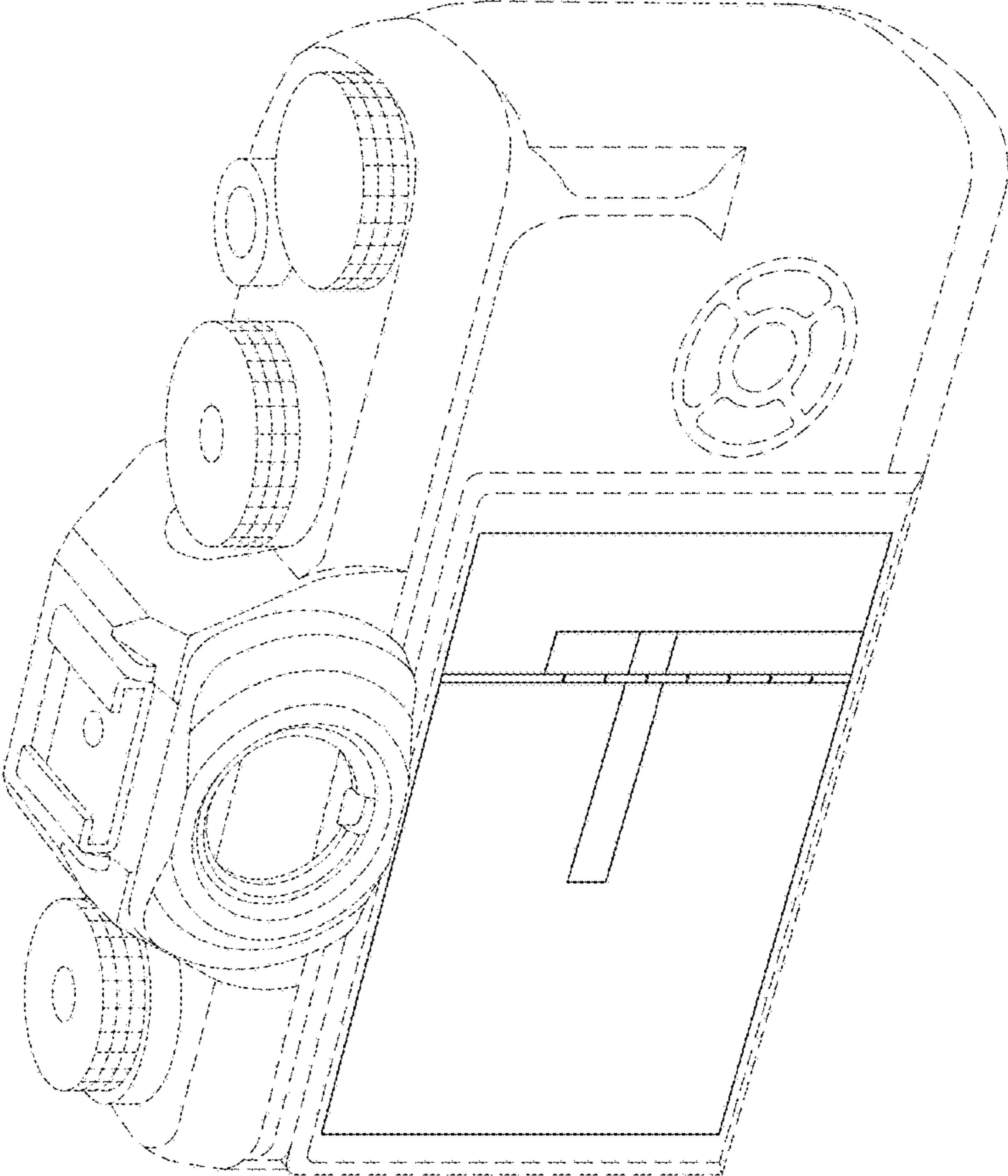

FIG. 2

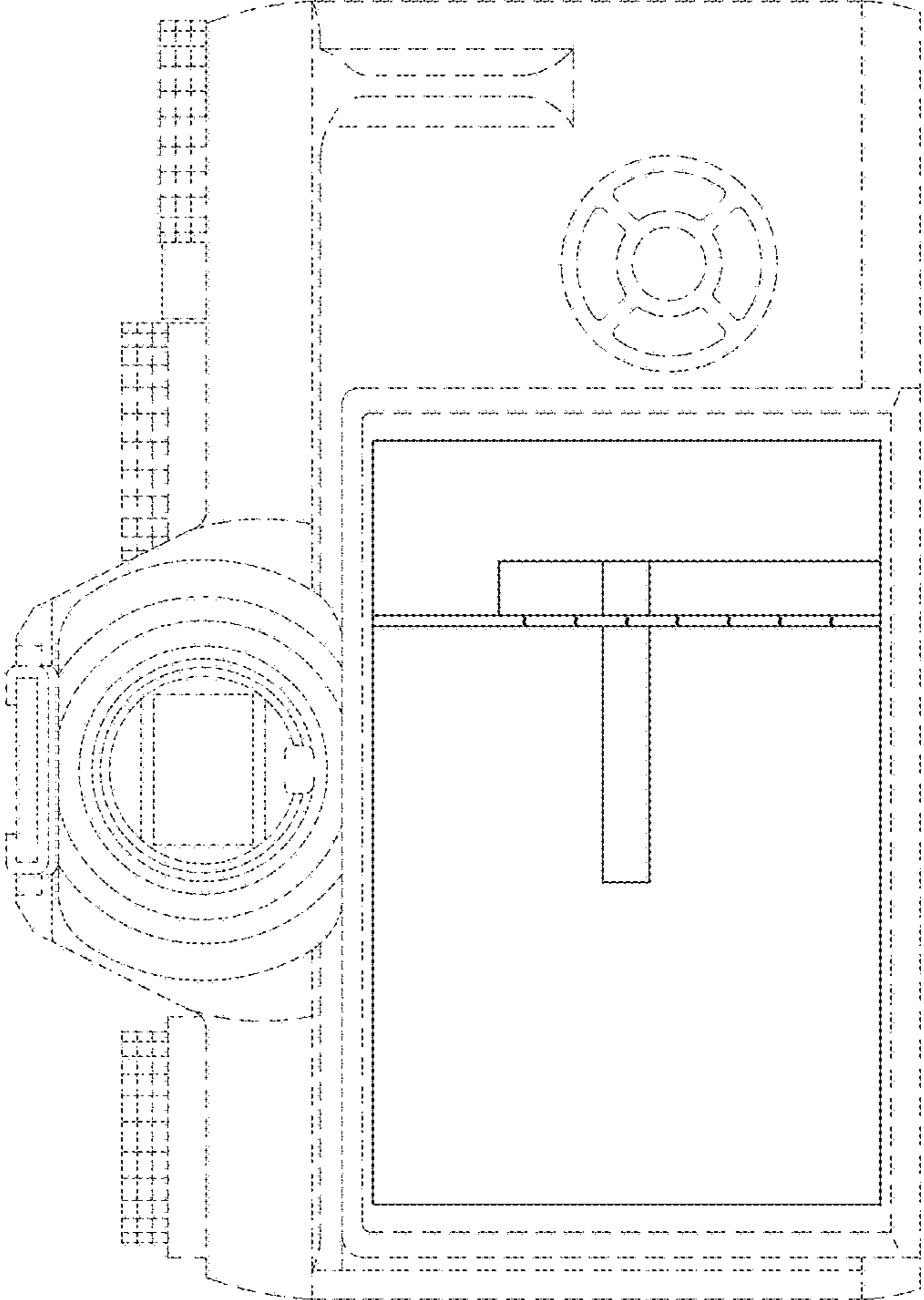

FIG. 3

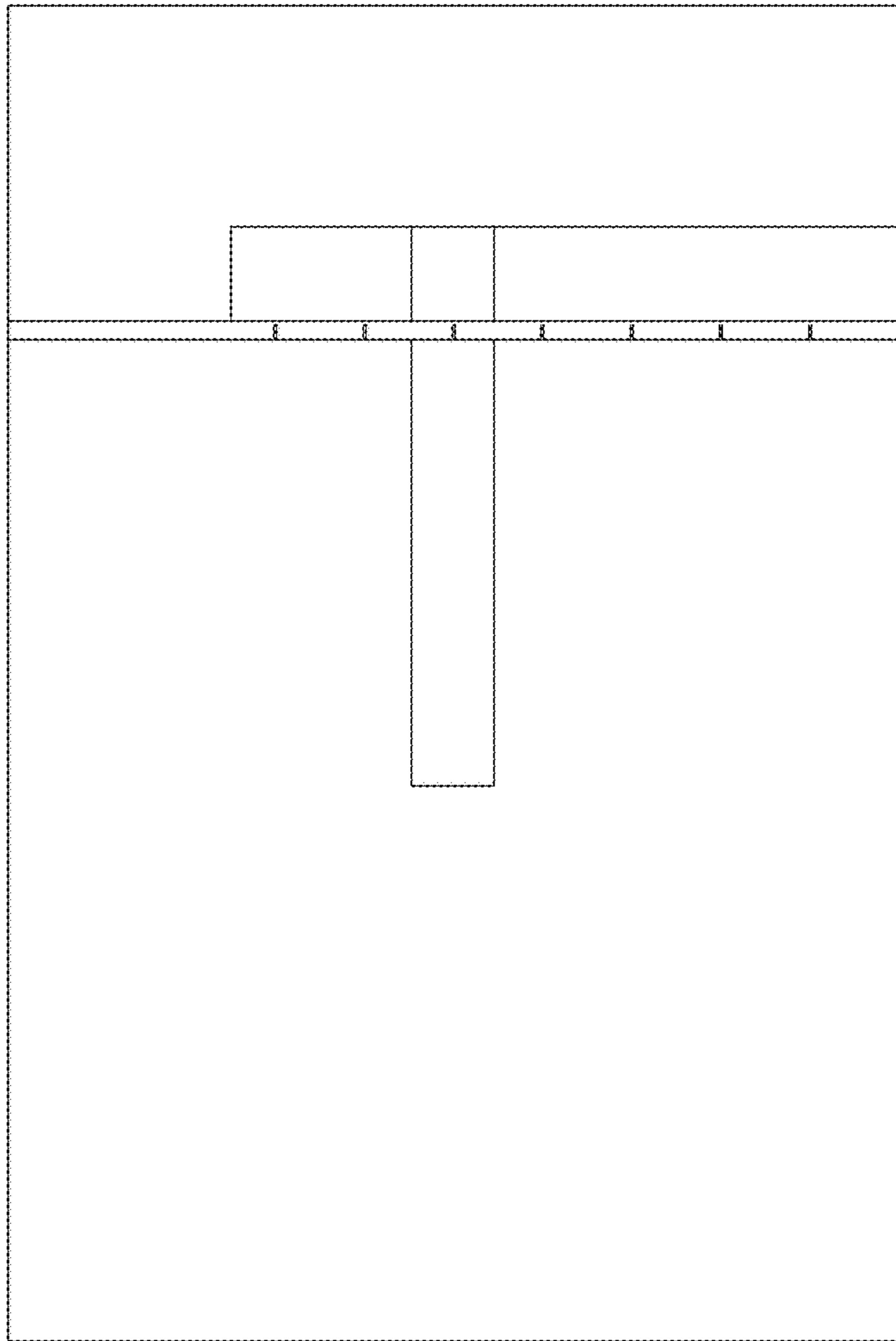

FIG. 4

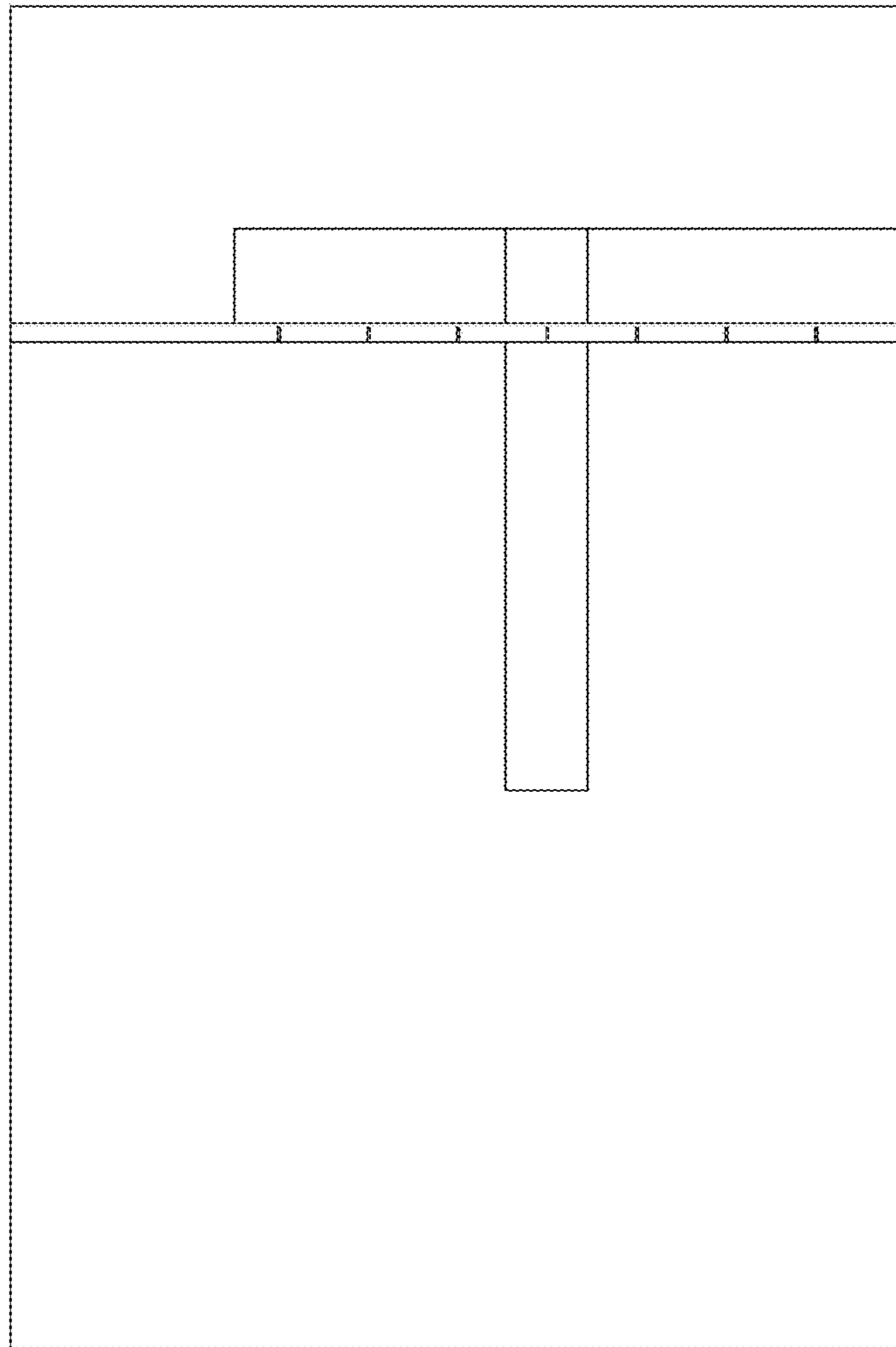

FIG. 5

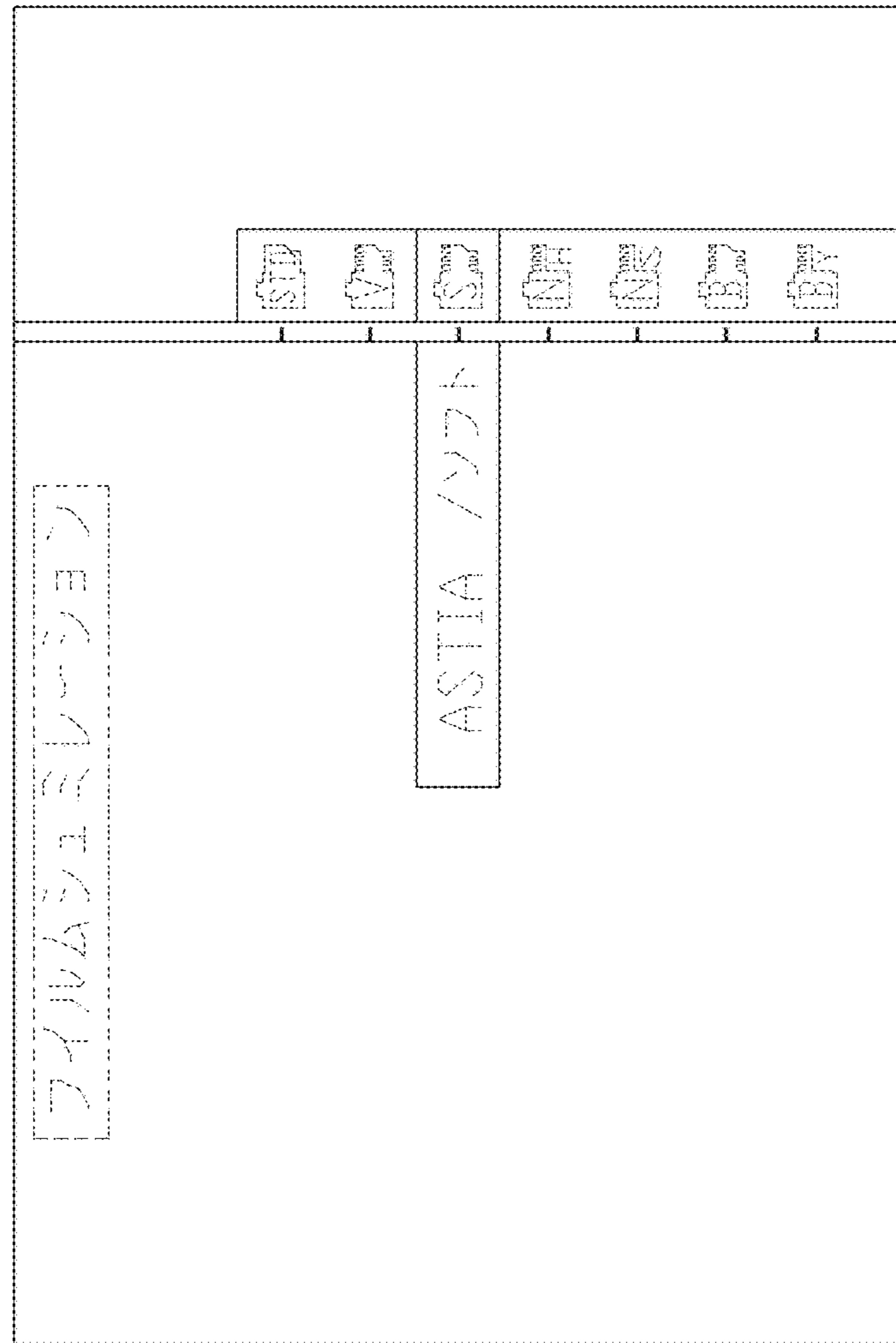

FIG. 6

