



US00D880980S

(12) **United States Design Patent**  
**Harrison**

(10) **Patent No.:** **US D880,980 S**

(45) **Date of Patent:** **\*\* Apr. 14, 2020**

(54) **LATCH HANDLE**

(71) Applicant: **WERNER CO.**, Greenville, PA (US)

(72) Inventor: **Craig Harrison**, Gulf Breeze, FL (US)

(73) Assignee: **WERNER CO.**, Greenville, PA (US)

(\*\*) Term: **15 Years**

(21) Appl. No.: **29/635,151**

(22) Filed: **Jan. 29, 2018**

(51) **LOC (12) Cl.** ..... **08-07**

(52) **U.S. Cl.**

USPC ..... **D8/331**

(58) **Field of Classification Search**

USPC ..... D8/330, 331, 333, 339, 343, 344, 345,  
D8/349, 354, 355, 356, 367, 382;  
292/256, 262, 281, 285, 288, DIG. 30,  
292/289, 297, DIG. 15, 259 R; 70/256,  
70/262, 281, 285, 288, DIG. 65, DIG. 35,  
70/30, 51, 52, 57, 57.1, 141, 431, 465,  
70/466, 29

CPC ..... E05C 19/10; E05C 19/18; E05C 3/044;  
E05C 17/44; E05C 19/005; E05B 73/00;  
B25G 3/00; B25G 3/12

See application file for complete search history.

(56) **References Cited**

**U.S. PATENT DOCUMENTS**

2,698,196 A \* 12/1954 Mangus ..... E05D 15/06  
292/300  
D424,406 S \* 5/2000 Frey ..... D8/331

D439,822 S \* 4/2001 Webber ..... D8/331  
D549,079 S \* 8/2007 Killins ..... D8/346  
D609,551 S \* 2/2010 Gibbs ..... D8/331  
D686,624 S \* 7/2013 Kuehn ..... D14/432  
D751,368 S \* 3/2016 Alley ..... D8/331  
D804,280 S \* 12/2017 Atkinson, Jr. .... D8/331  
D820,066 S \* 6/2018 Chen ..... D8/334  
D826,027 S \* 8/2018 Carey ..... D8/331  
D826,691 S \* 8/2018 Peterse ..... D8/343

\* cited by examiner

*Primary Examiner* — Manpreet S Matharu

*Assistant Examiner* — Yolanda Robinson

(74) *Attorney, Agent, or Firm* — McDonnell Boehnen  
Hulbert & Berghoff LLP

(57) **CLAIM**

The ornamental design for a latch handle, as shown and described.

**DESCRIPTION**

FIG. 1 is a front perspective view of a latch handle showing my new design;

FIG. 2 is a front view thereof;

FIG. 3 is a rear view thereof;

FIG. 4 is a right side view thereof;

FIG. 5 is a left side view thereof;

FIG. 6 is a top plan view thereof; and,

FIG. 7 is a bottom plan view thereof.

**1 Claim, 7 Drawing Sheets**

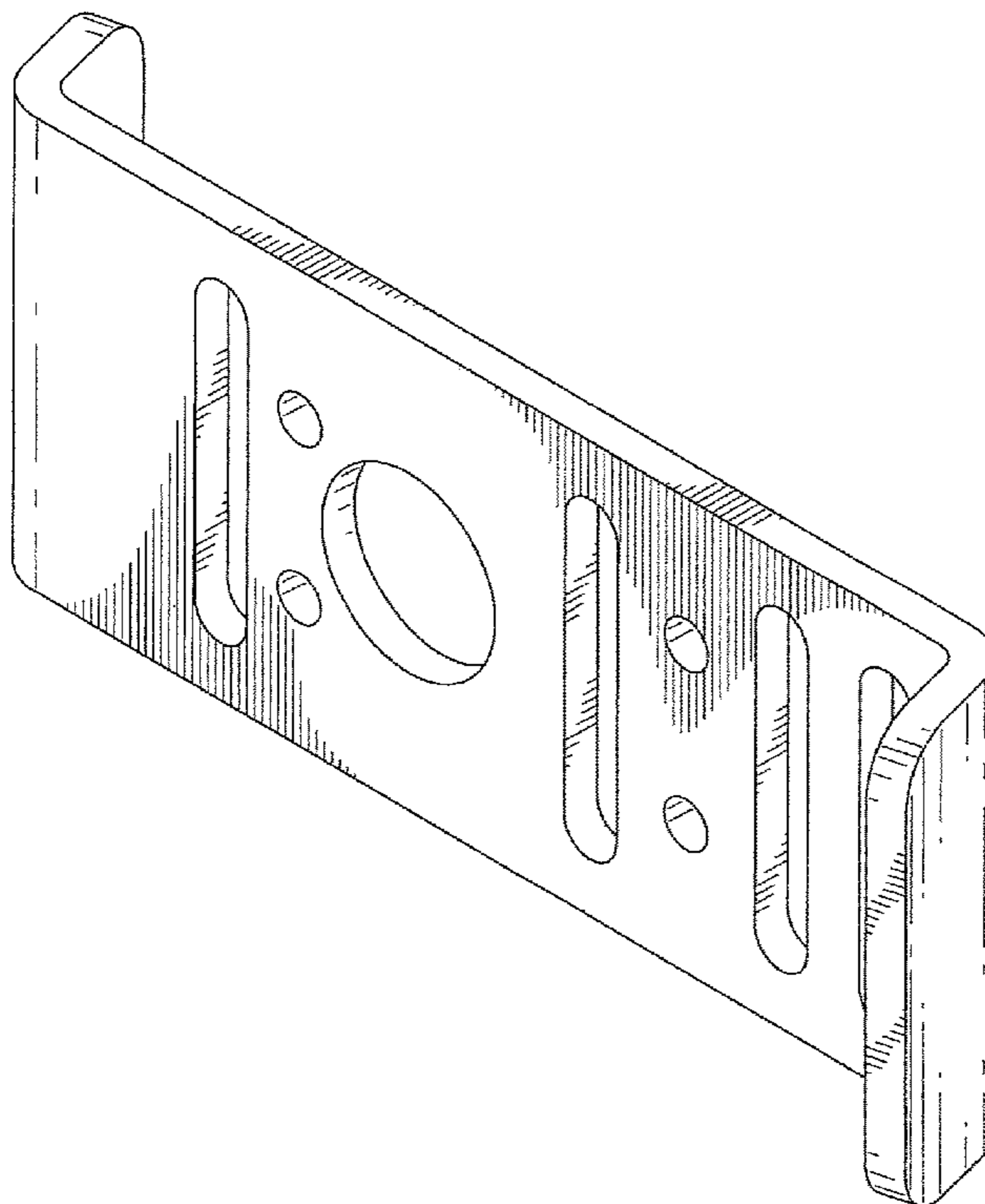

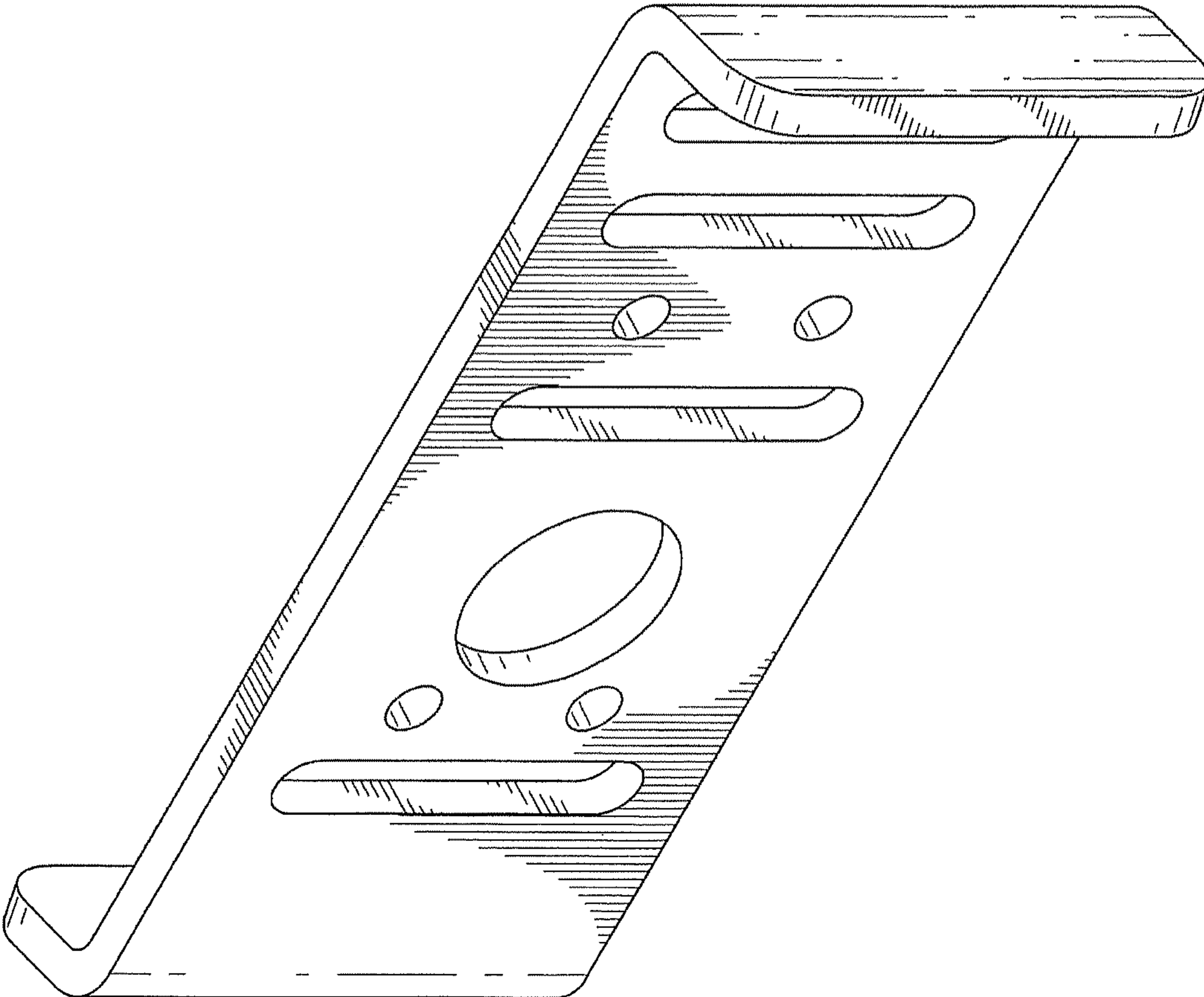

FIG.1

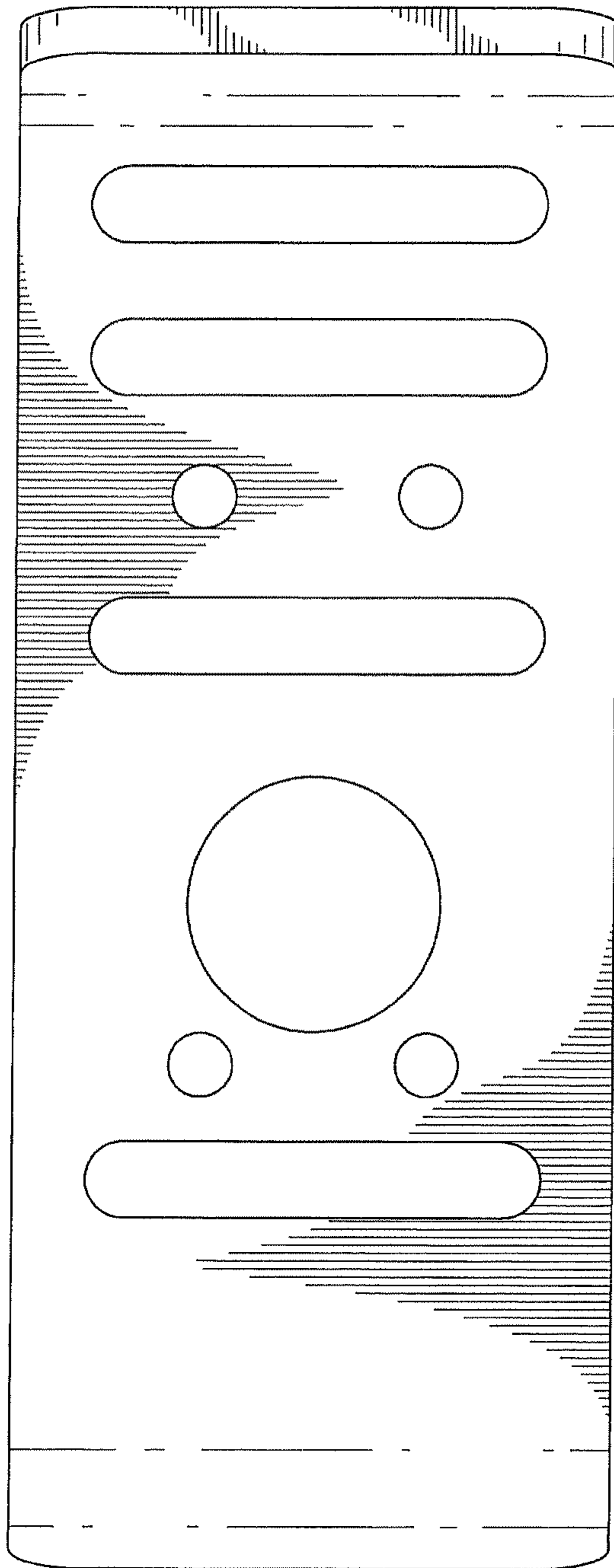

FIG.2

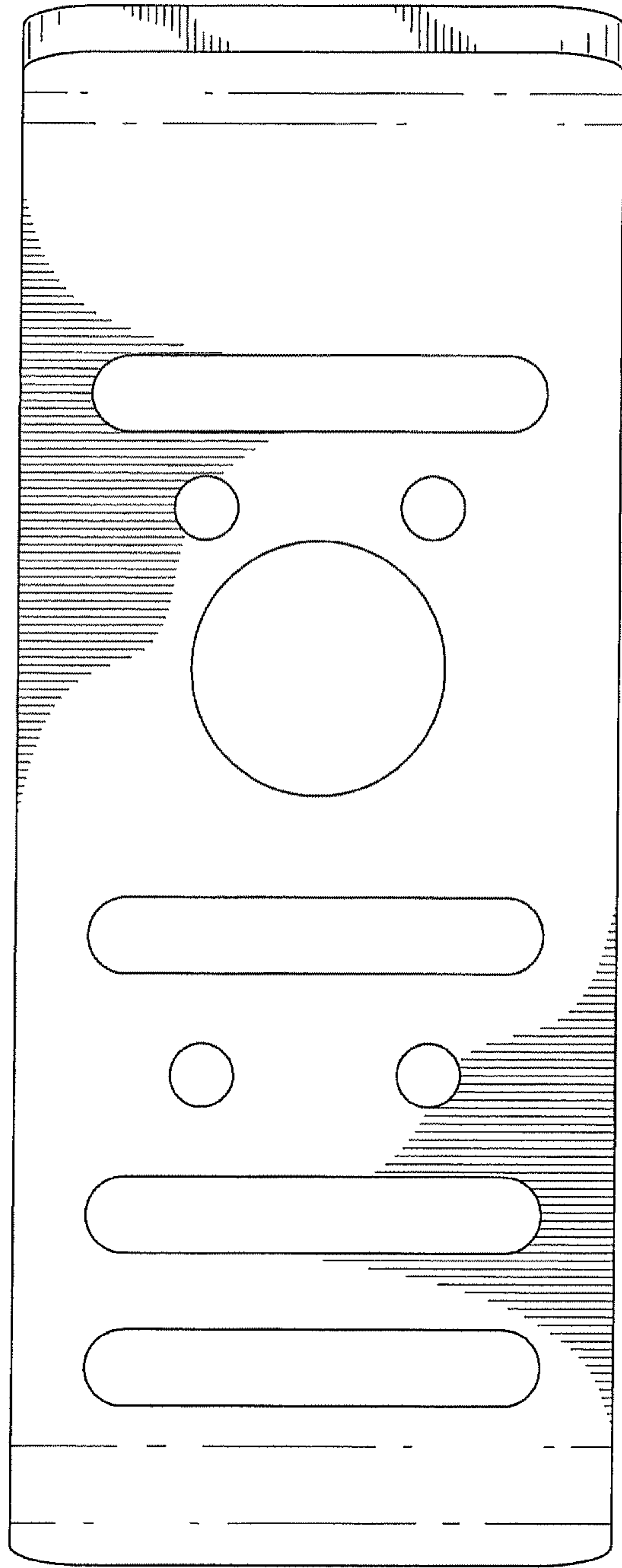

FIG. 3

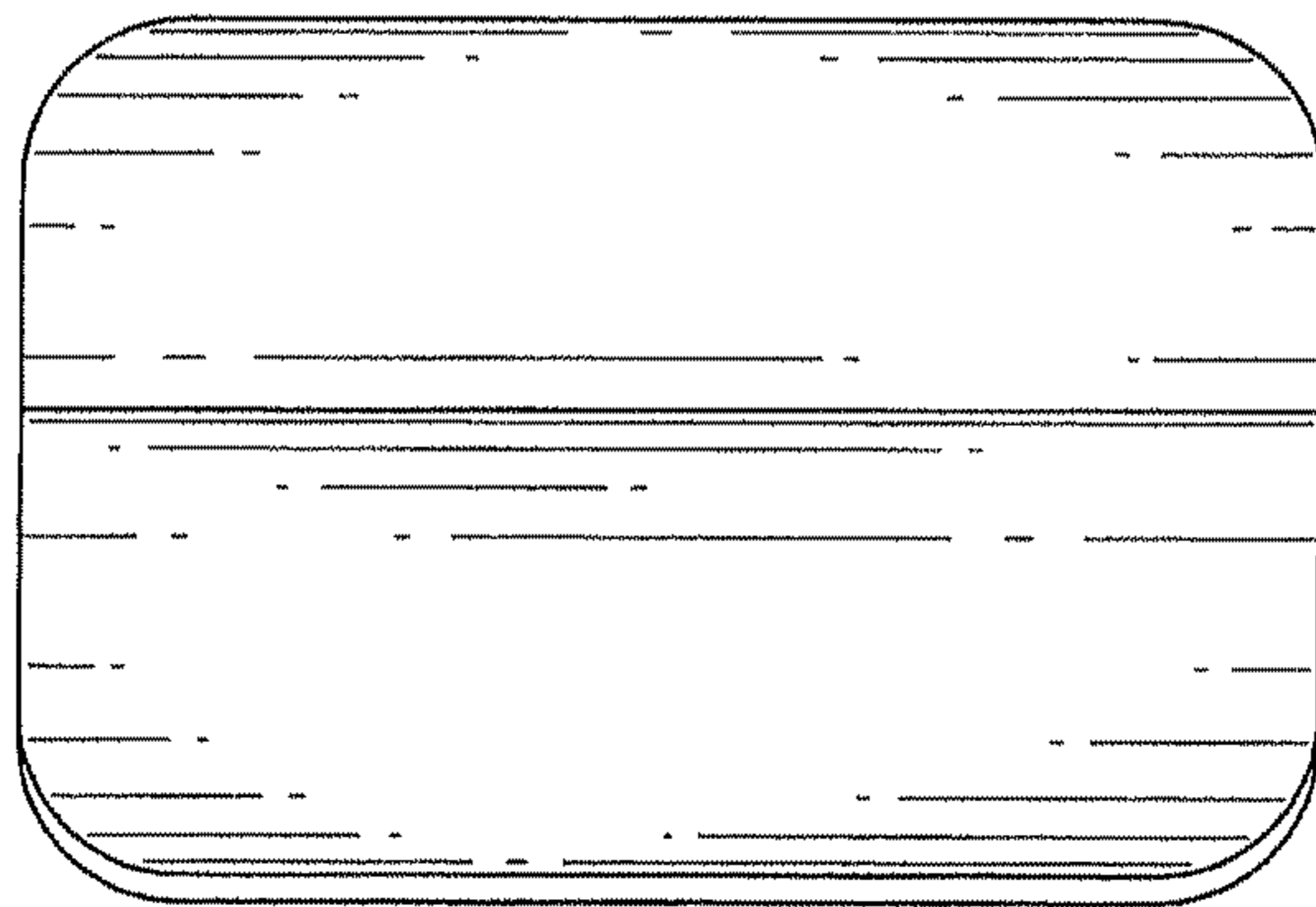

FIG.4

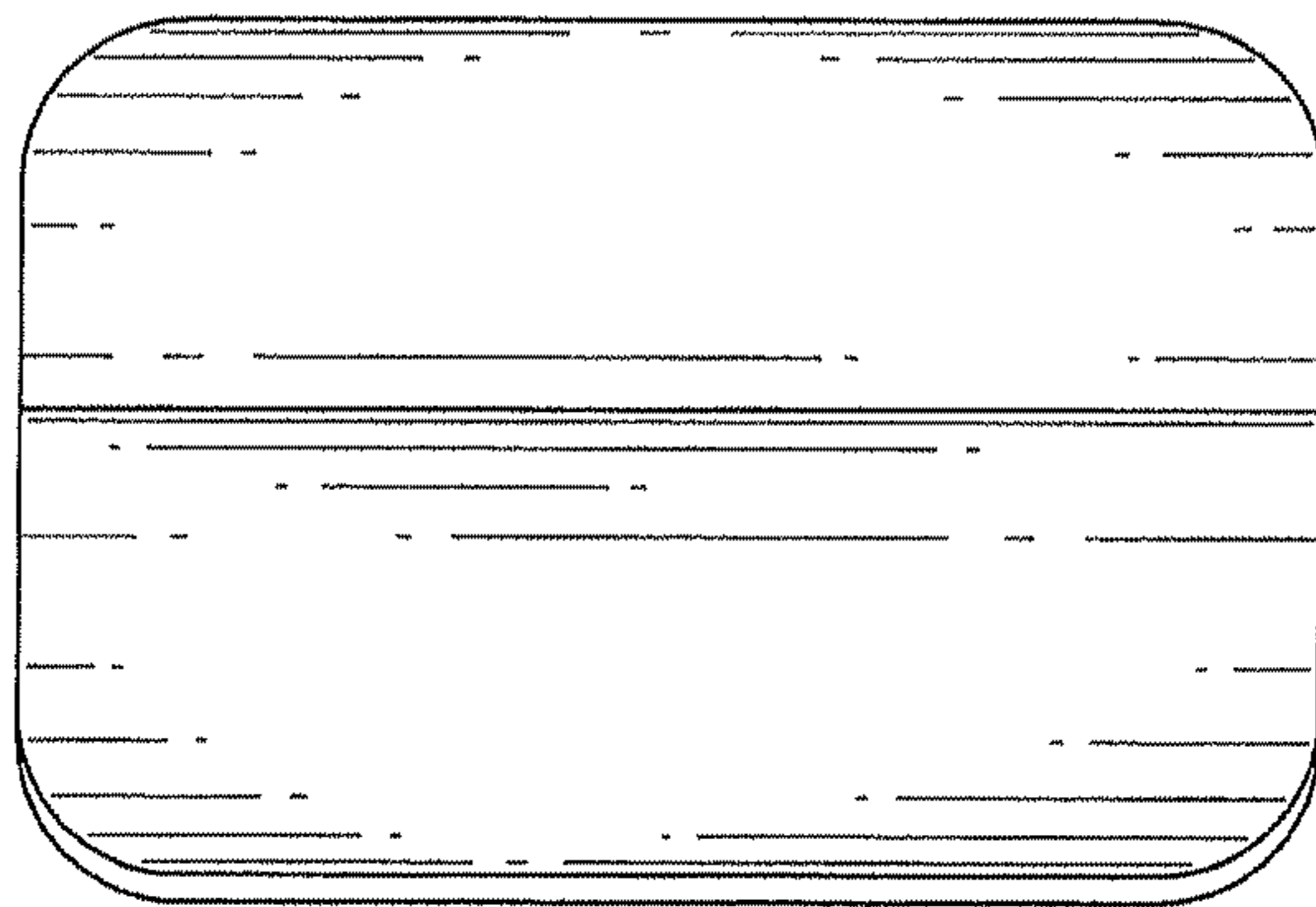

FIG. 5

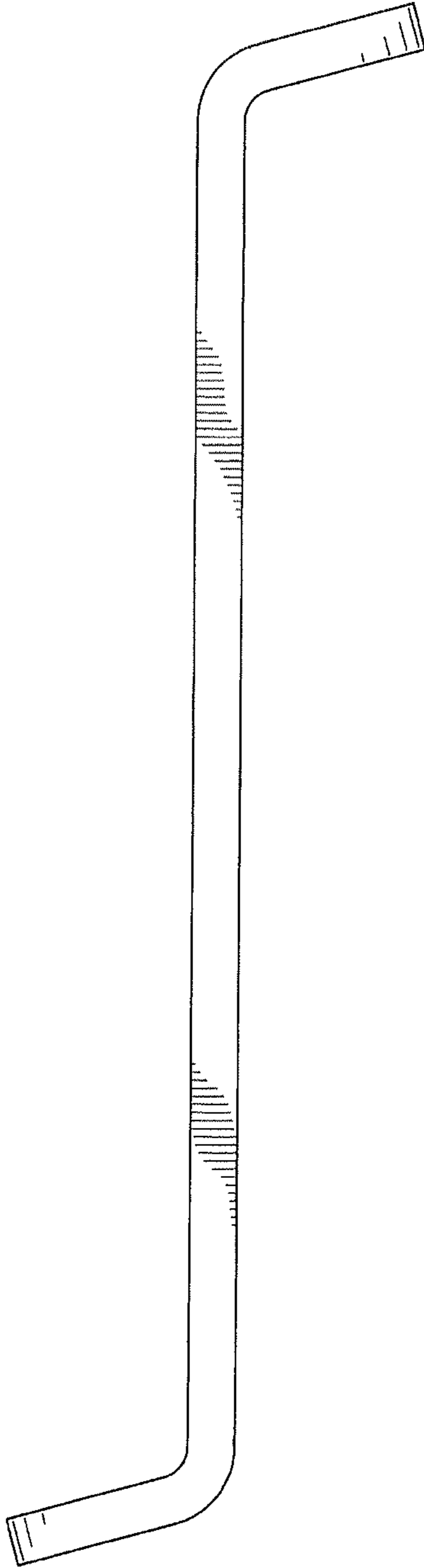

FIG. 6

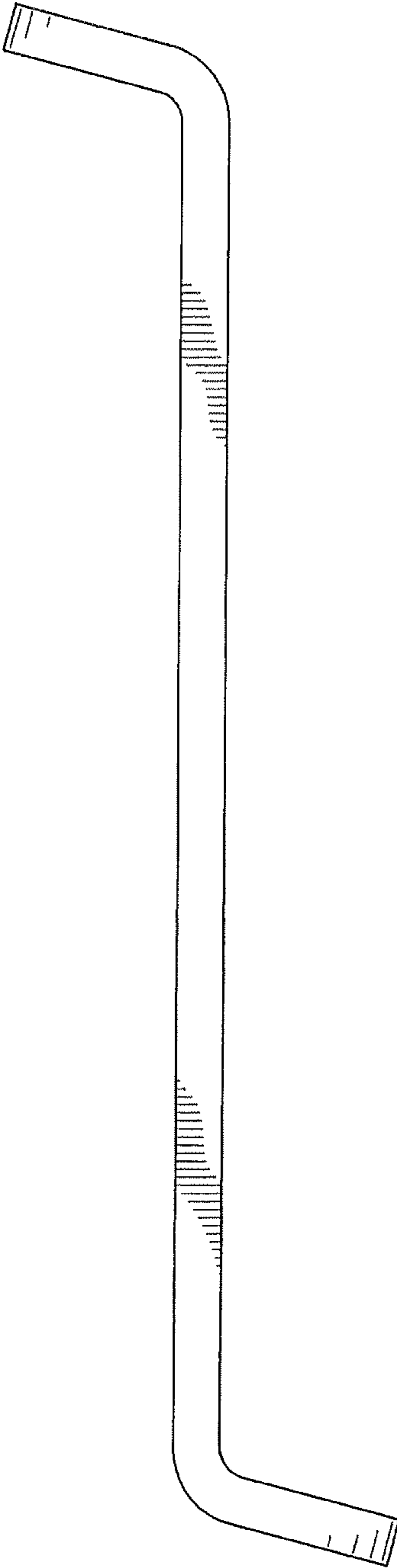

FIG. 7