



US00D880969S

(12) **United States Design Patent**  
**Lenart**

(10) **Patent No.:** **US D880,969 S**  
(45) **Date of Patent:** **\*\* Apr. 14, 2020**

- (54) **CONSTRUCTION WRECKING TOOL**
- (71) Applicant: **Edward Lenart**, Farmington Hills, MI (US)
- (72) Inventor: **Edward Lenart**, Farmington Hills, MI (US)
- (\*\*) Term: **15 Years**
- (21) Appl. No.: **29/662,409**
- (22) Filed: **Sep. 5, 2018**
- (51) **LOC (12) Cl.** ..... **08-05**
- (52) **U.S. Cl.**  
USPC ..... **D8/89**
- (58) **Field of Classification Search**  
USPC ..... D8/14, 16, 88, 89, 81, 105; D32/46  
CPC ..... B25C 11/00; B66F 15/00; E04D 15/00;  
E04G 23/086  
See application file for complete search history.

6,715,734	B1 *	4/2004	Wise	.....	B25C 11/00	254/25
8,365,378	B1 *	2/2013	Lenart	.....	B25B 33/00	29/253
8,567,760	B2 *	10/2013	Sindt	.....	B25C 11/00	254/25
8,955,827	B2 *	2/2015	Brown	.....	B25F 1/006	254/21
D790,944	S *	7/2017	Wise	.....	D8/89	
D831,450	S *	10/2018	Arvinte	.....	D8/14	
2005/0062026	A1 *	3/2005	Holcomb	.....	B25C 11/00	254/25

\* cited by examiner

*Primary Examiner* — Philip S Hyder

(57) **CLAIM**

The ornamental design for a construction wrecking tool, as shown and described.

**DESCRIPTION**

FIG. 1 is a front view of a construction wrecking tool showing my new design;  
 FIG. 2 is a rear view of the construction wrecking tool;  
 FIG. 3 is a left side view of the construction wrecking tool;  
 FIG. 4 is a right side view of the construction wrecking tool;  
 FIG. 5 is a top view of the construction wrecking tool;  
 FIG. 6 is a bottom view of the construction wrecking tool;  
 FIG. 7 is a top front side perspective view of the construction wrecking tool; and,  
 FIG. 8 is a bottom rear side perspective view of the construction wrecking tool.

**1 Claim, 6 Drawing Sheets**

(56) **References Cited**  
 U.S. PATENT DOCUMENTS

2,593,304	A *	4/1952	Howard	.....	A01K 55/00	449/61
4,176,417	A *	12/1979	Ruff	.....	A47L 13/08	7/161
D386,057	S *	11/1997	Hreha	.....	D8/89	
5,695,171	A *	12/1997	Shine	.....	B25C 11/00	254/25
D444,690	S *	7/2001	Bond	.....	B66F 15/00	D8/16

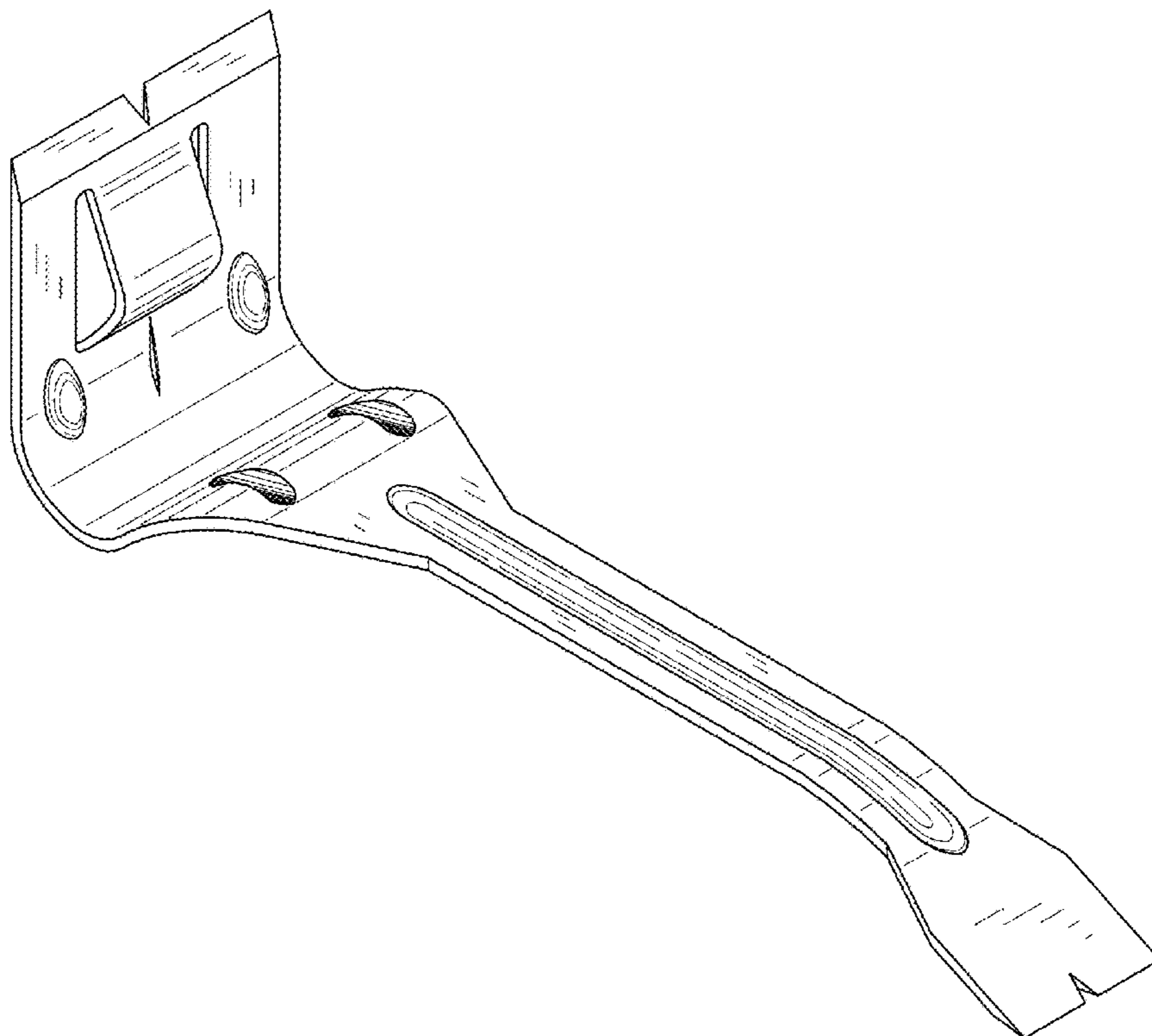

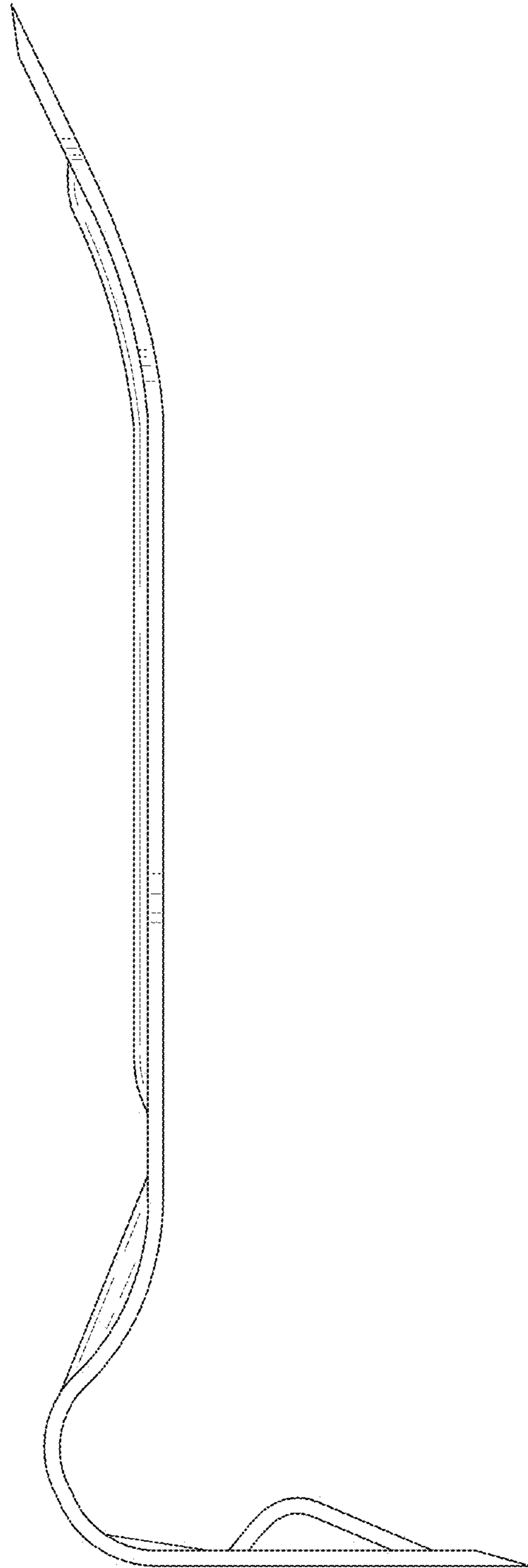

FIG. 1

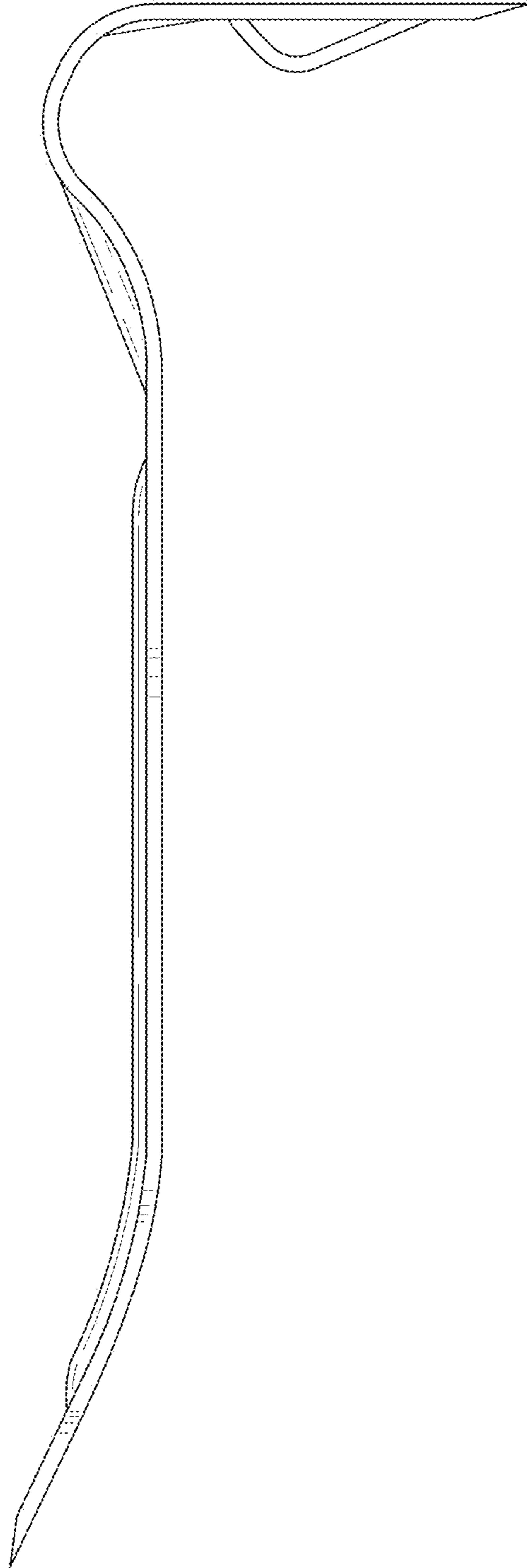

FIG. 2

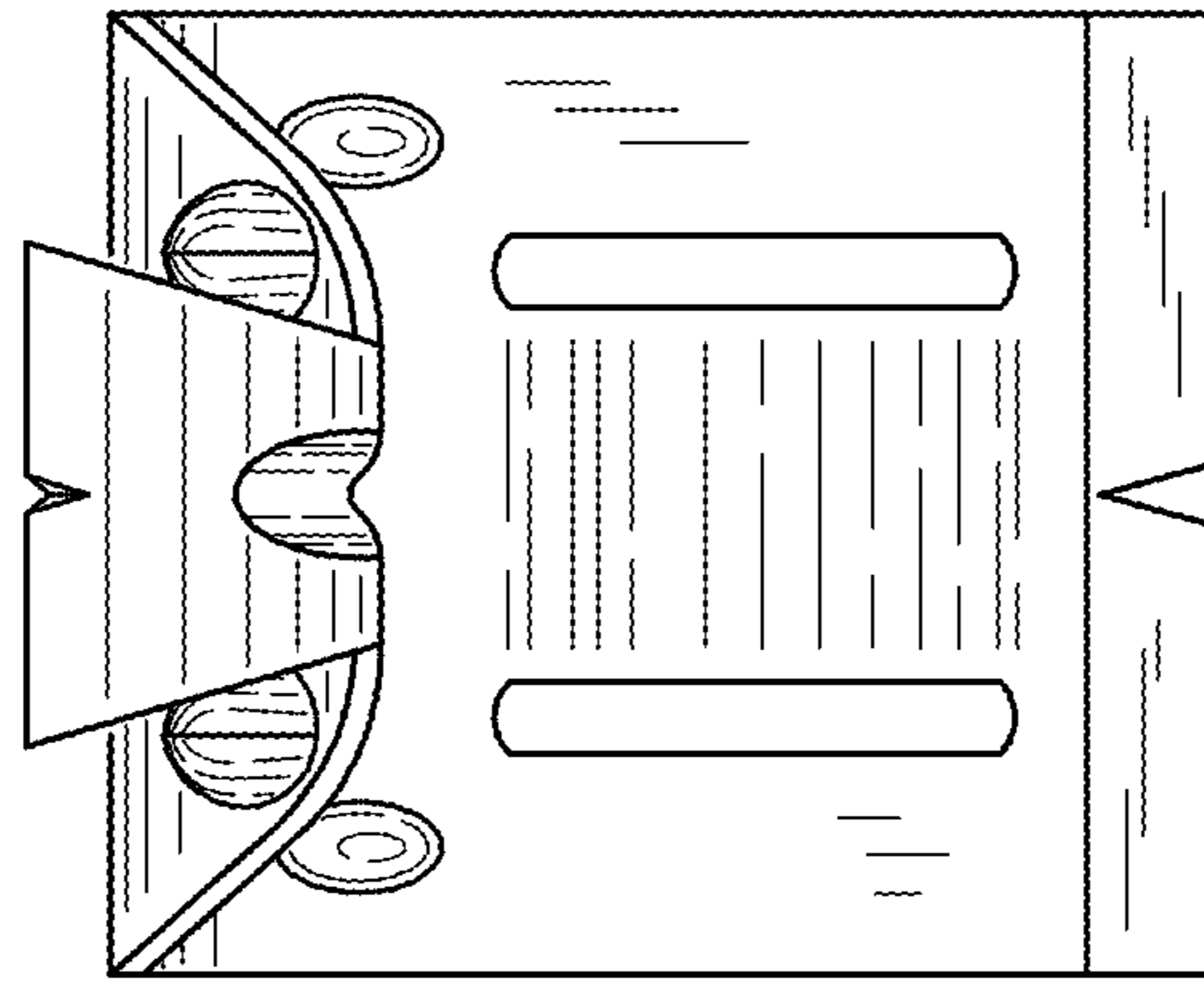

FIG. 4

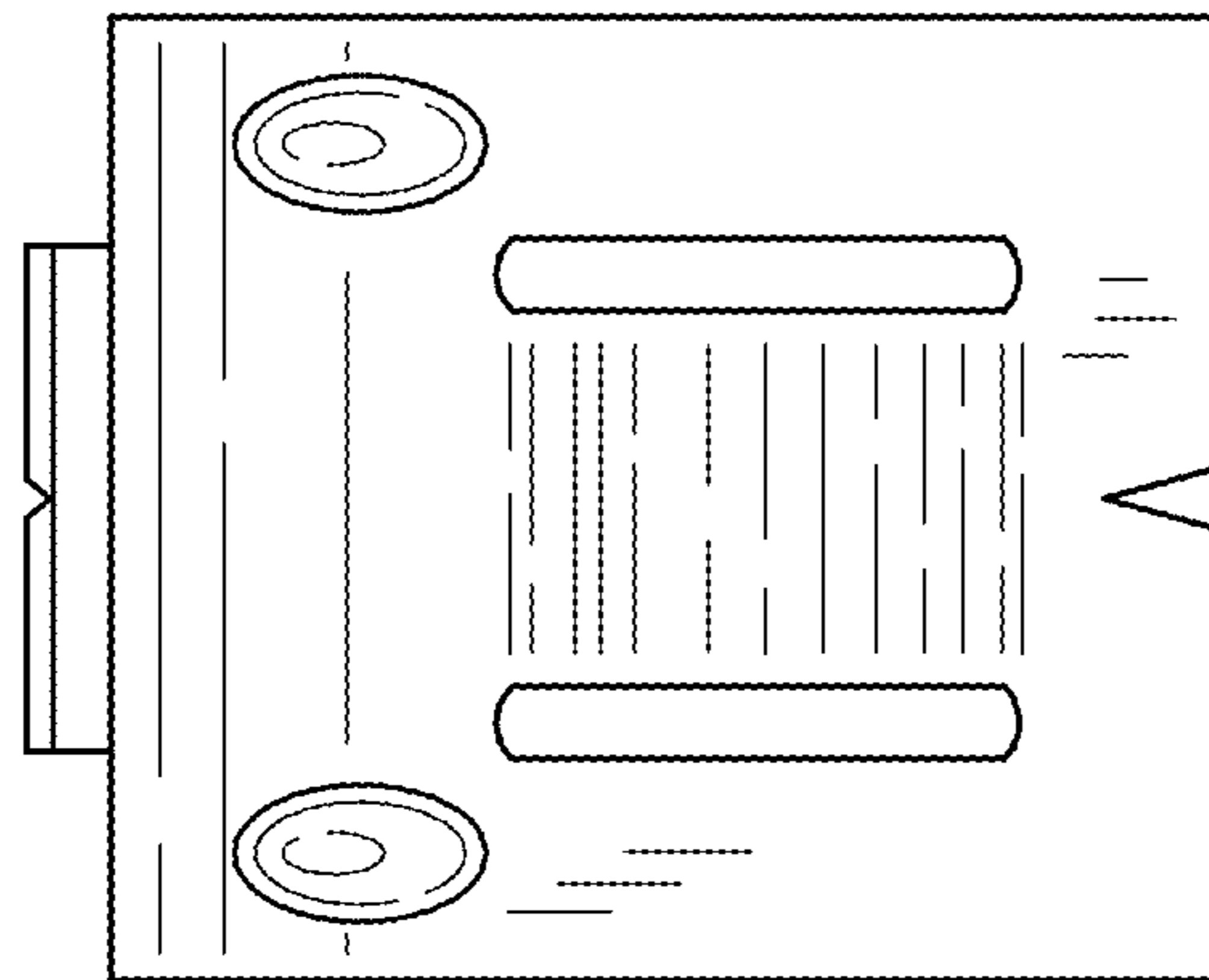

FIG. 3

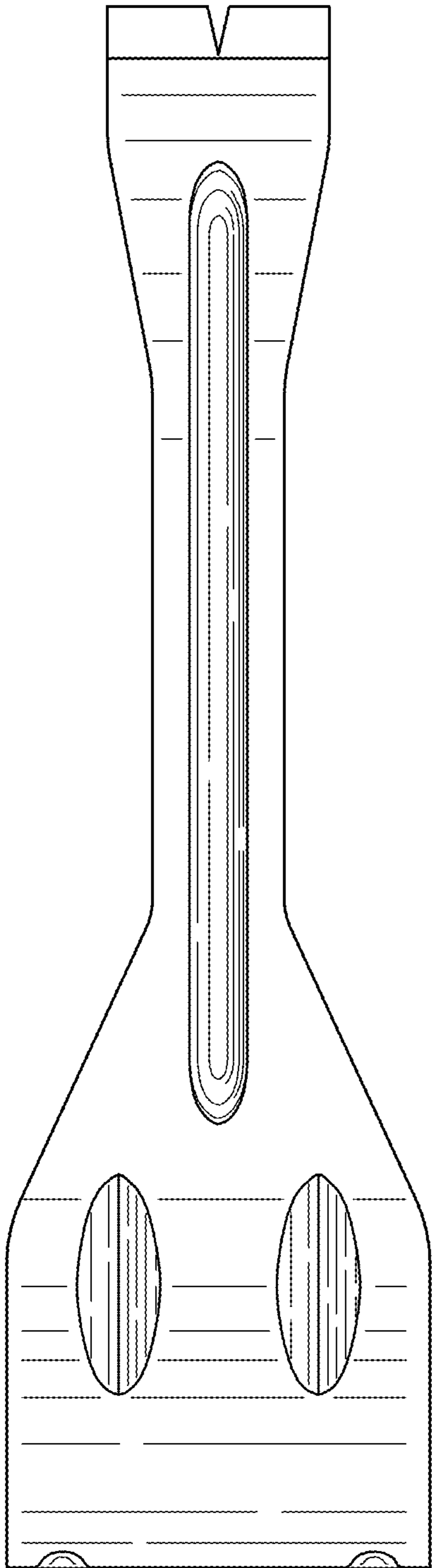

FIG. 5

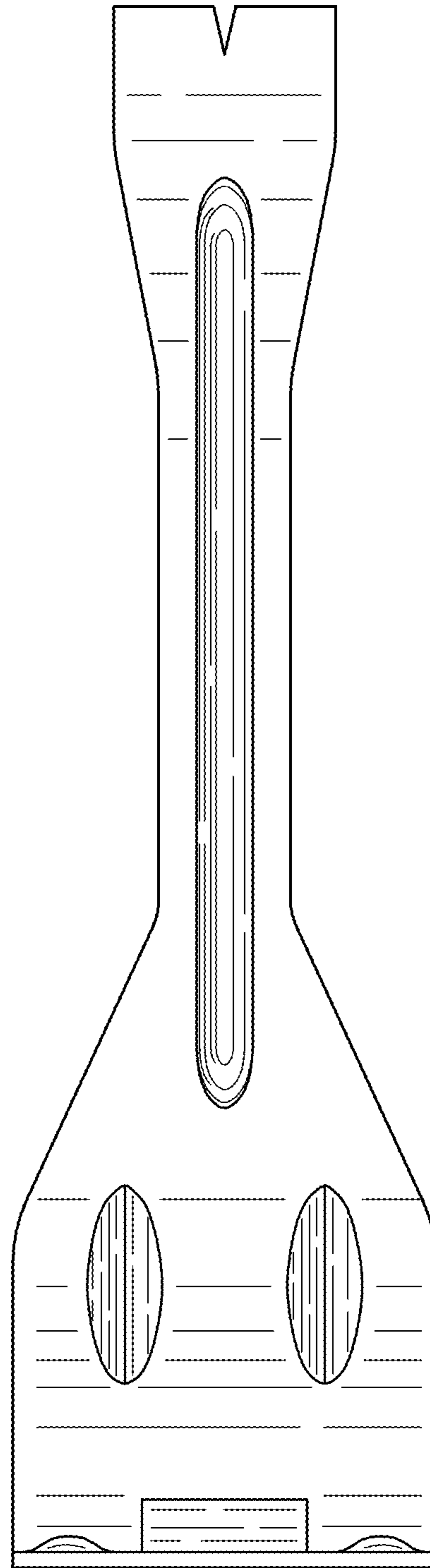

FIG. 6

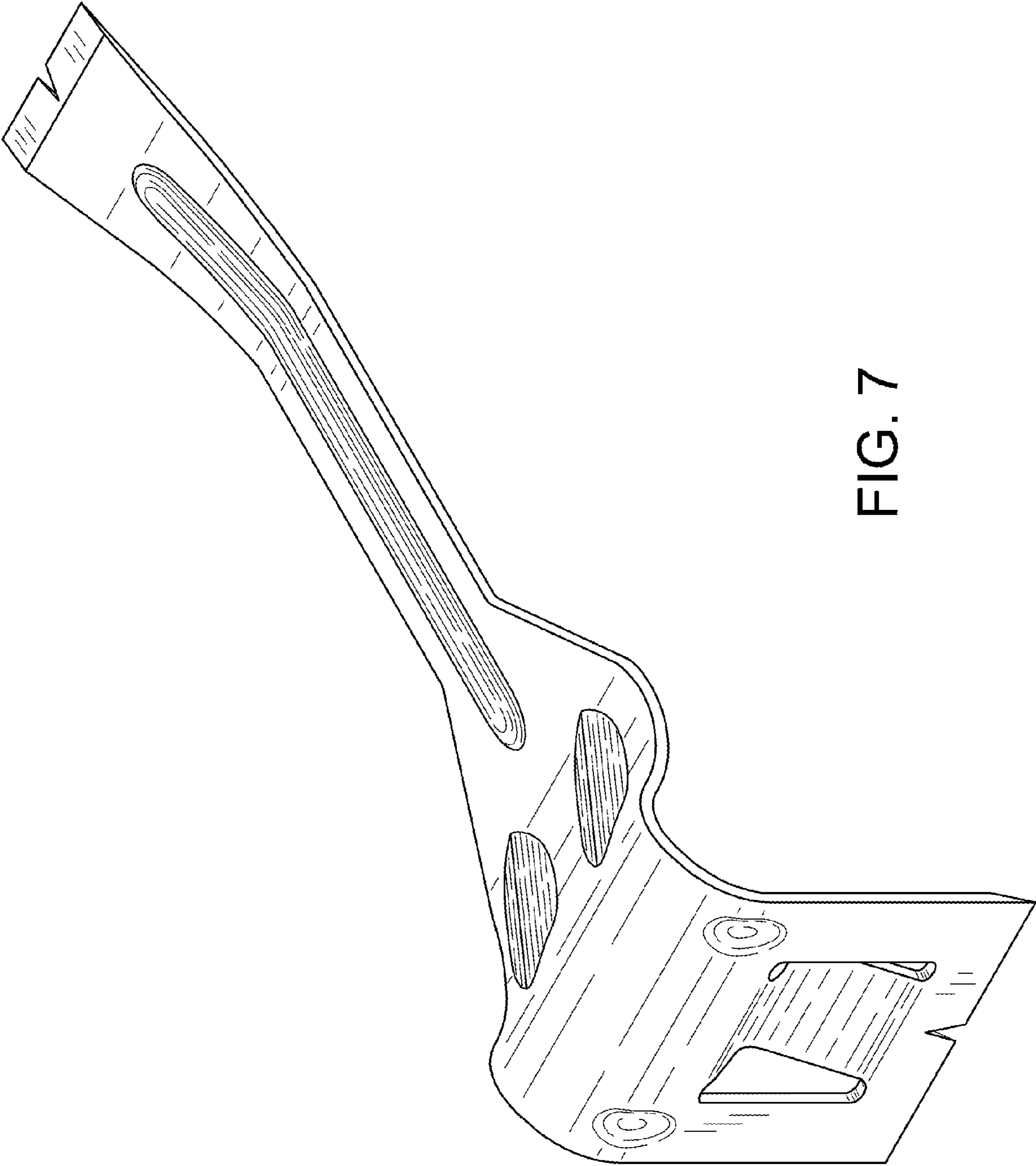

FIG. 7

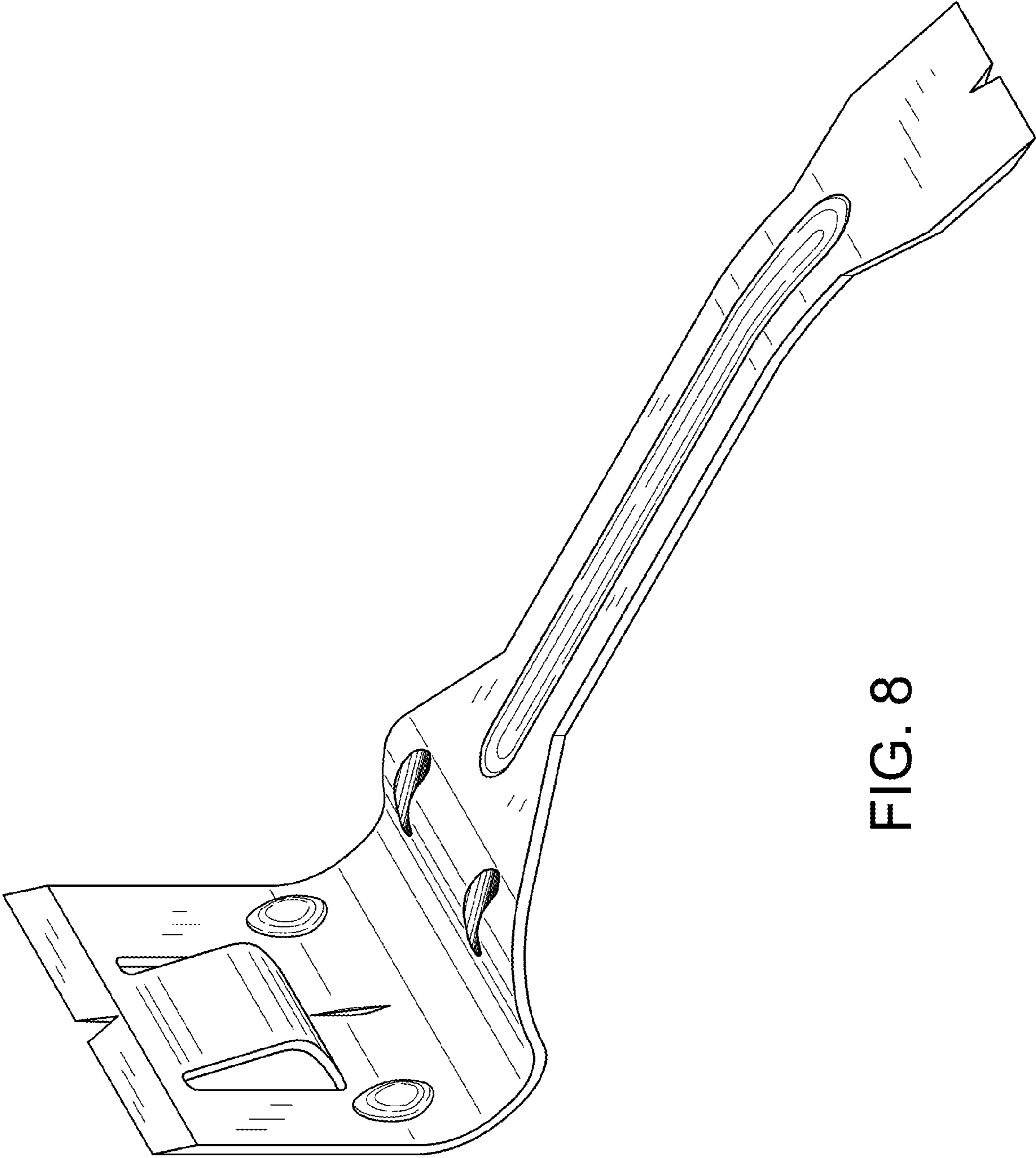

FIG. 8