



US00D880854S

(12) **United States Design Patent**
Jusic

(10) **Patent No.:** **US D880,854 S**

(45) **Date of Patent:** **** Apr. 14, 2020**

(54) **CROSSBODY BAG**

(71) Applicant: **Skunk, Inc.**, Carson, CA (US)

(72) Inventor: **Alis Jusic**, Carson, CA (US)

(73) Assignee: **Skunk, Inc.**, Carson, CA (US)

(**) Term: **15 Years**

(21) Appl. No.: **29/679,051**

(22) Filed: **Feb. 1, 2019**

(51) **LOC (12) Cl.** **03-01**

(52) **U.S. Cl.**
USPC **D3/245**

(58) **Field of Classification Search**
USPC D3/232–233, 240–243, 245–246
CPC A45C 1/024; A45C 3/06
See application file for complete search history.

(56) **References Cited**

U.S. PATENT DOCUMENTS

D419,763 S *	2/2000	Wiebe	D3/232
D447,342 S *	9/2001	Guy	D3/301
D707,963 S *	7/2014	Szewczyk	D3/232
D854,827 S *	7/2019	Yuan	D3/289
D870,456 S *	12/2019	Xia	D3/301

OTHER PUBLICATIONS

amazon.com, Inc., Skunk Kross Smell Proof Fanny Pack Hipster Bag w/Combo Lock, <https://www.amazon.com/Skunk-Kross-Smell-Proof-Hipster/dp/B07F1NMG7Z>, prior to date of filing, 1 page.

Skunk, Inc, Kross—Black, <https://skunkbags.com/shop/all-bags/kross/>, prior to date of filing, 1 page.

* cited by examiner

Primary Examiner — Holly H Baynham

(74) *Attorney, Agent, or Firm* — Traverse Legal, PLC

(57) **CLAIM**

I claim the ornamental design for a crossbody bag, as shown and described.

DESCRIPTION

FIG. 1 is a perspective view of a crossbody bag;
FIG. 2 is a front elevation view of the crossbody bag of FIG. 1;
FIG. 3 is a rear elevation view of the crossbody bag of FIG. 1;
FIG. 4 is right side elevation view of the crossbody bag of FIG. 1;
FIG. 5 is a left side elevation view of the crossbody bag of FIG. 1;
FIG. 6 is a top plan view of the crossbody bag of FIG. 1; and,
FIG. 7 is a bottom plan view of the crossbody bag of FIG. 1.

The broken lines shown in the drawings are included for purposes of illustrating environment and form no part of the claimed design. The surface shading lines show contour and/or distinguish between open and solid areas. The surface shading lines are not surface ornamentation.

1 Claim, 7 Drawing Sheets

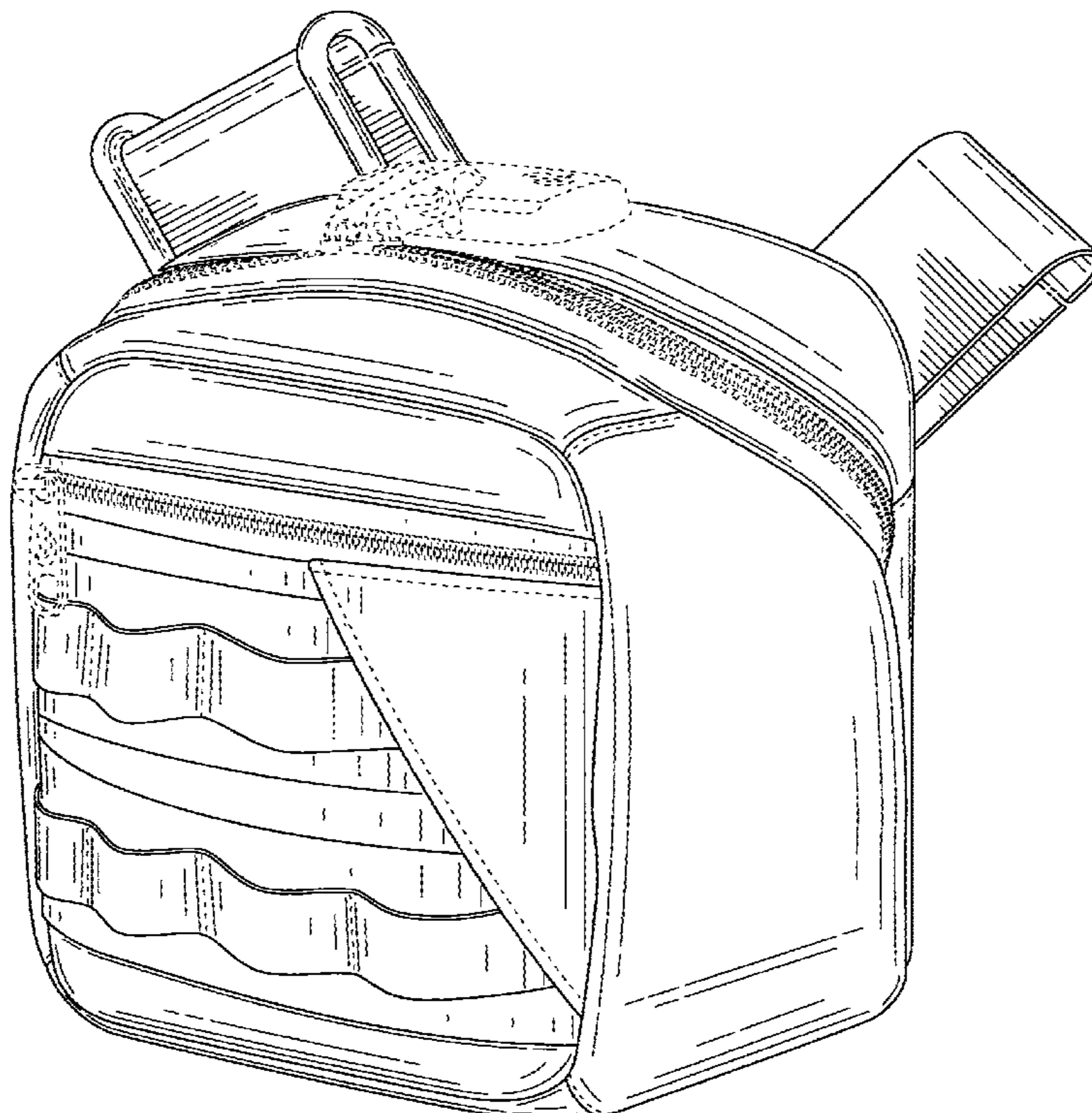

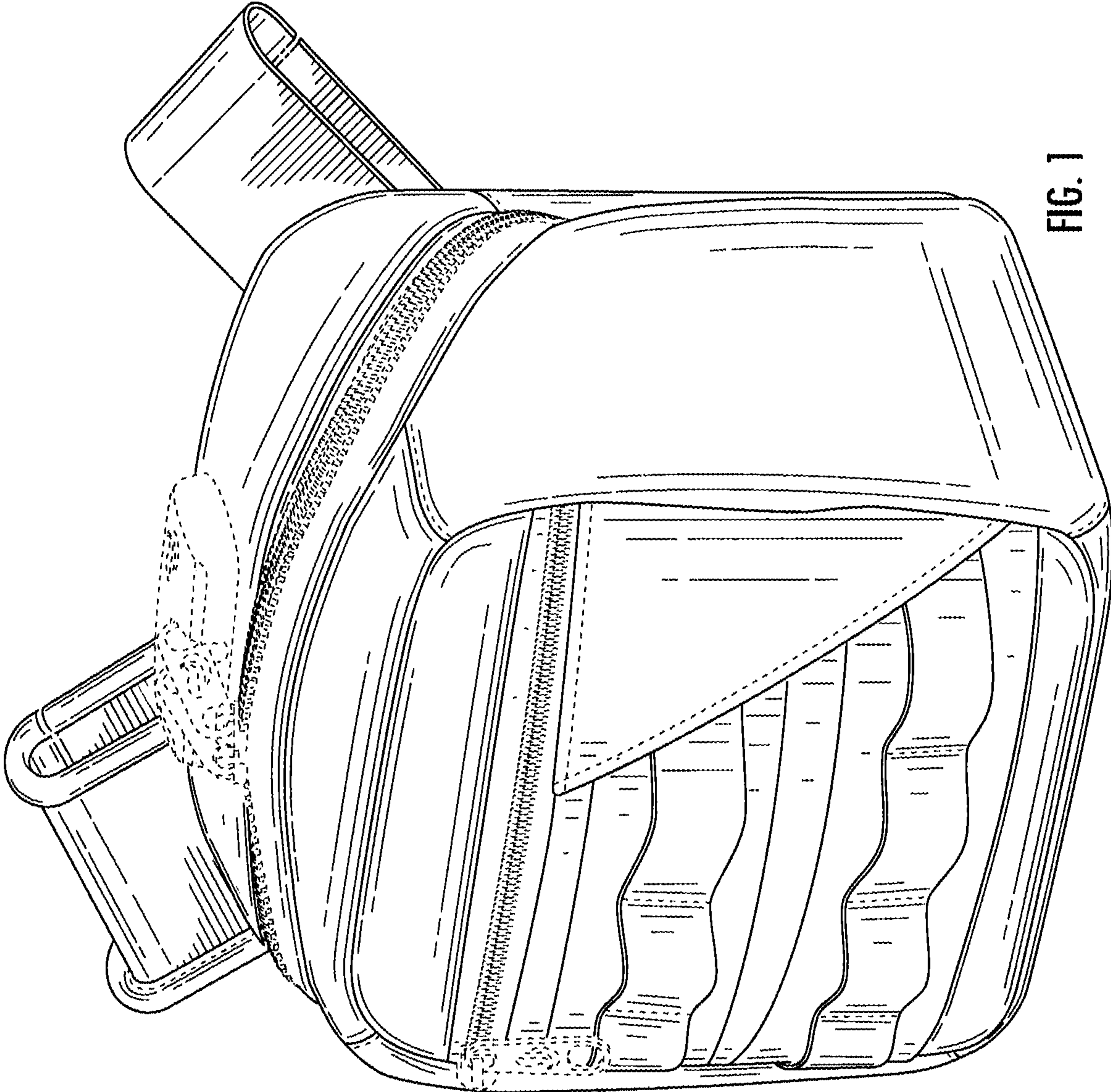

FIG. 1

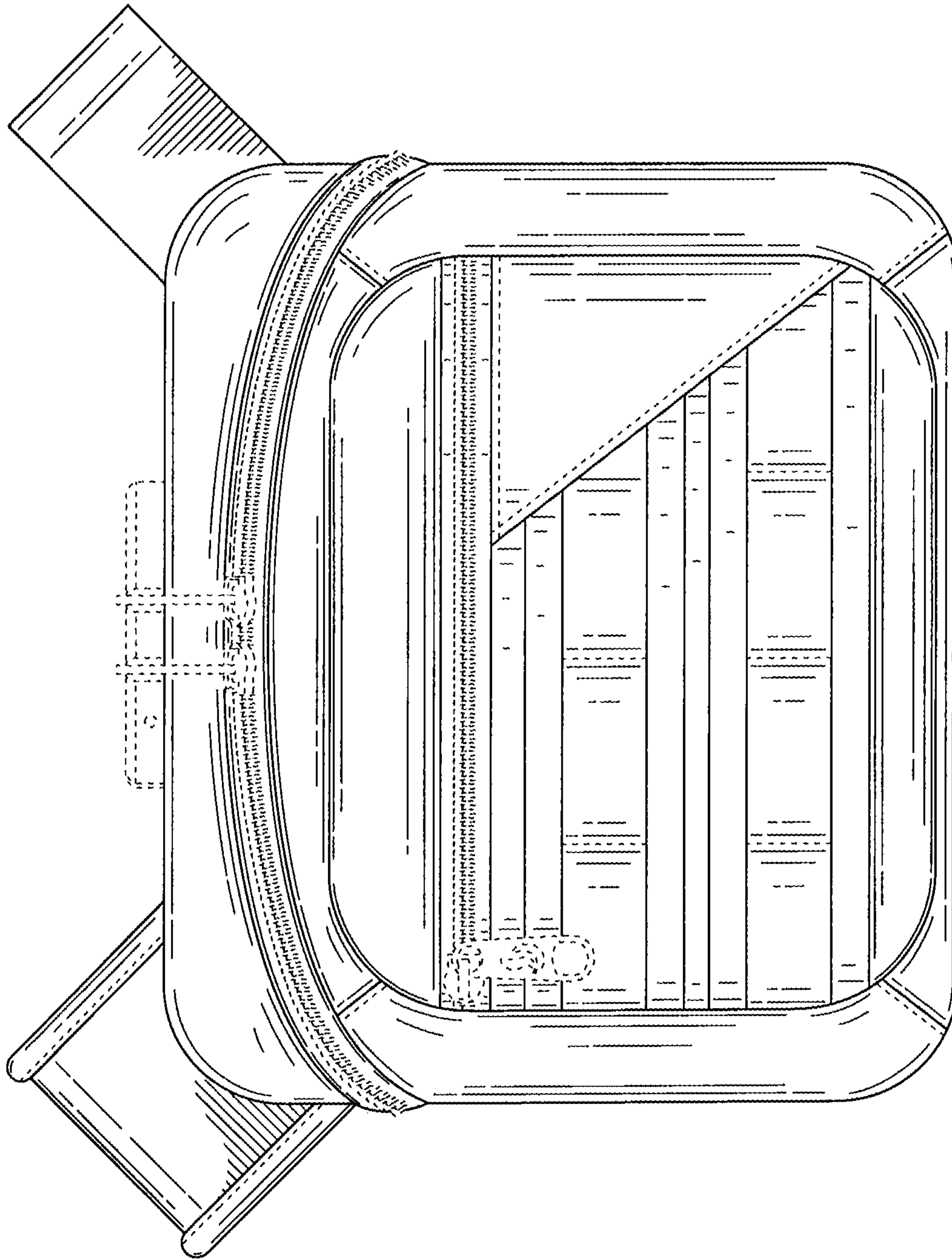

FIG. 2

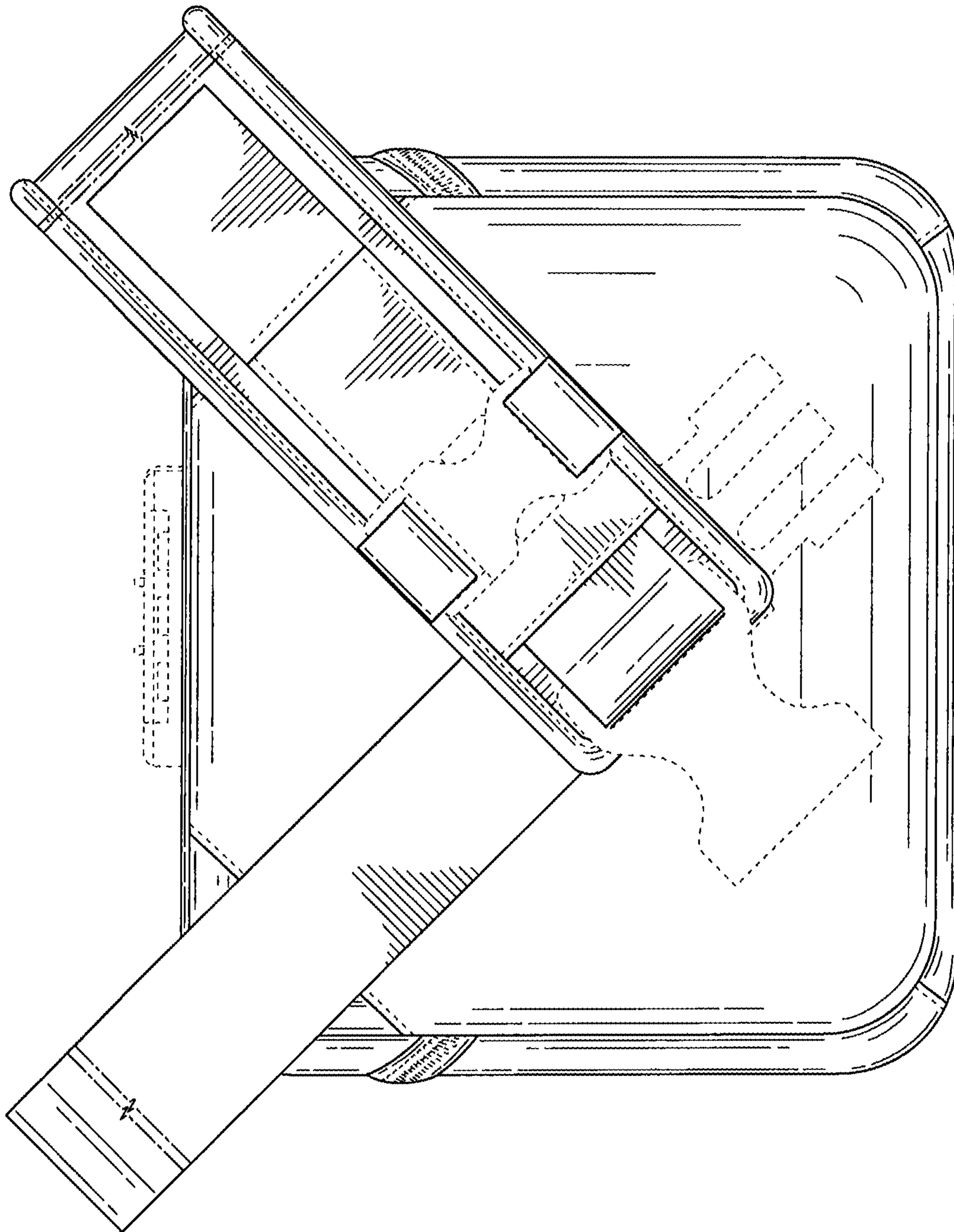

FIG. 3

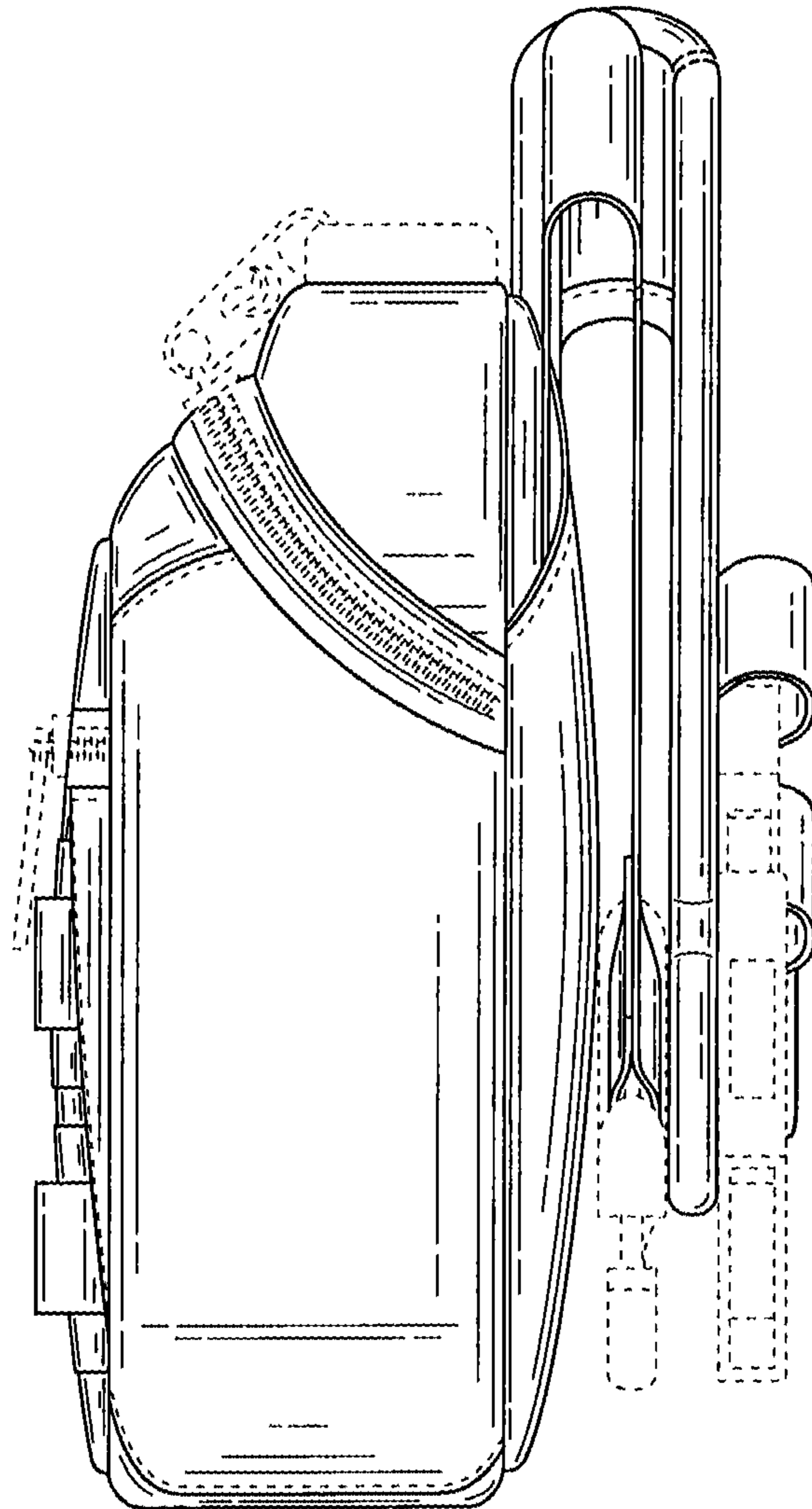

FIG. 4

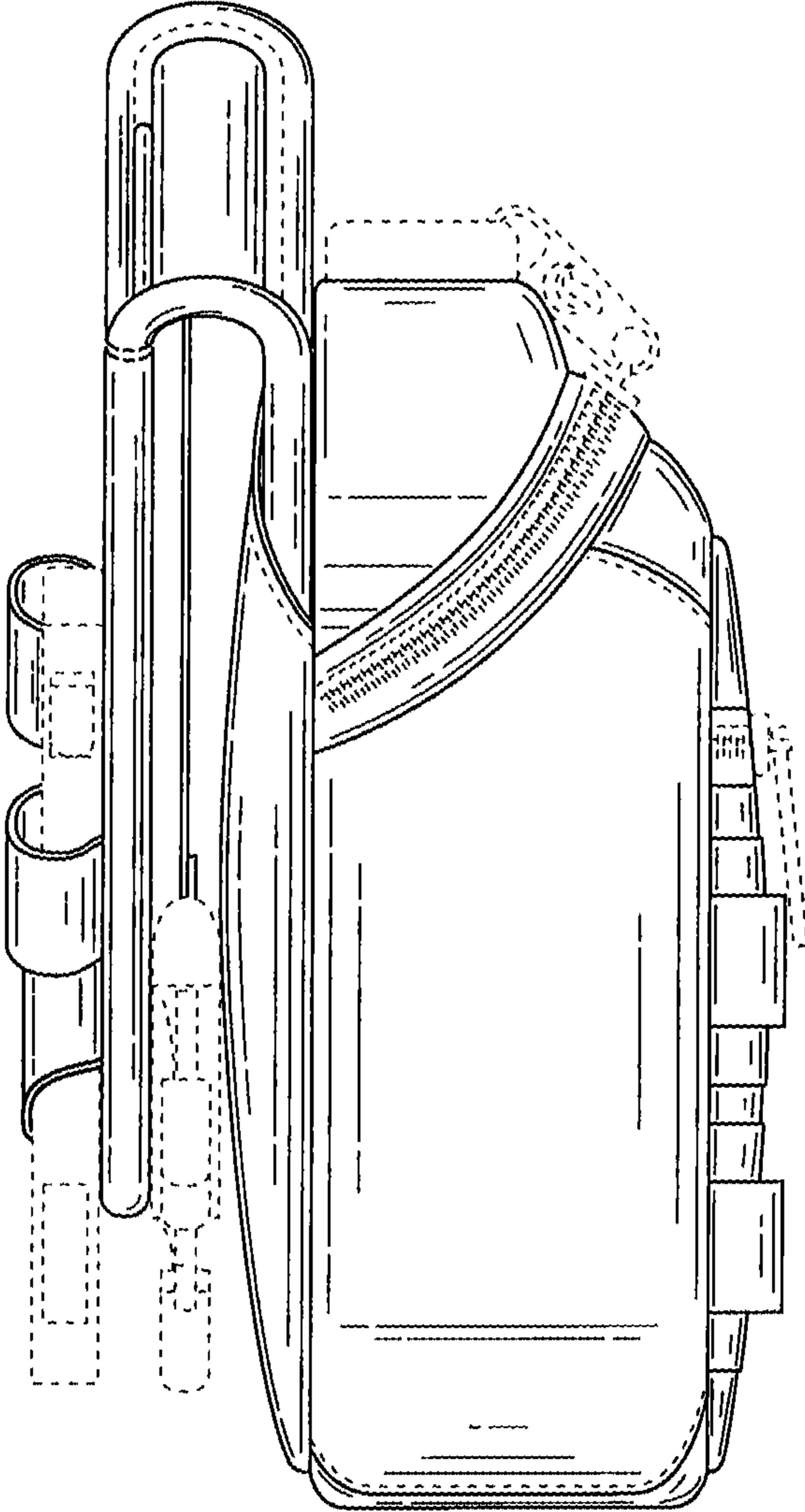

FIG. 5

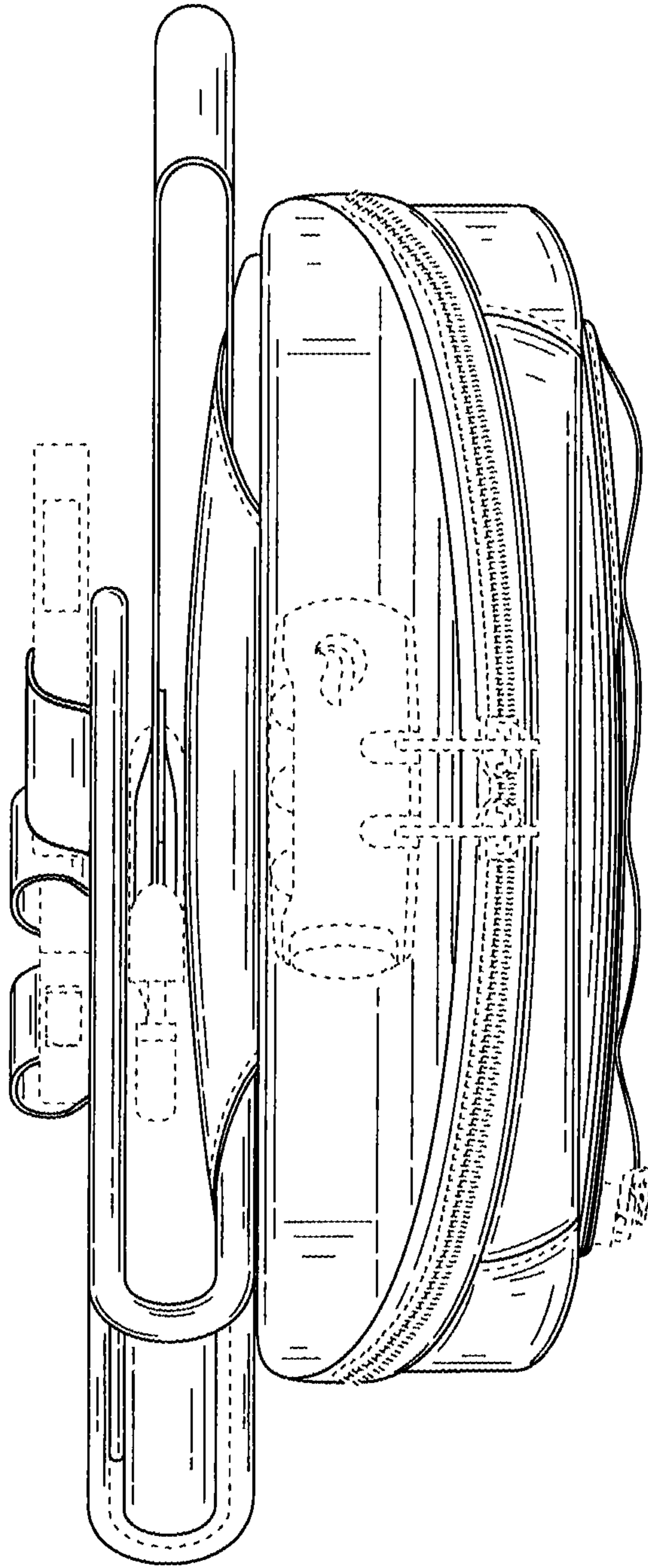

FIG. 6

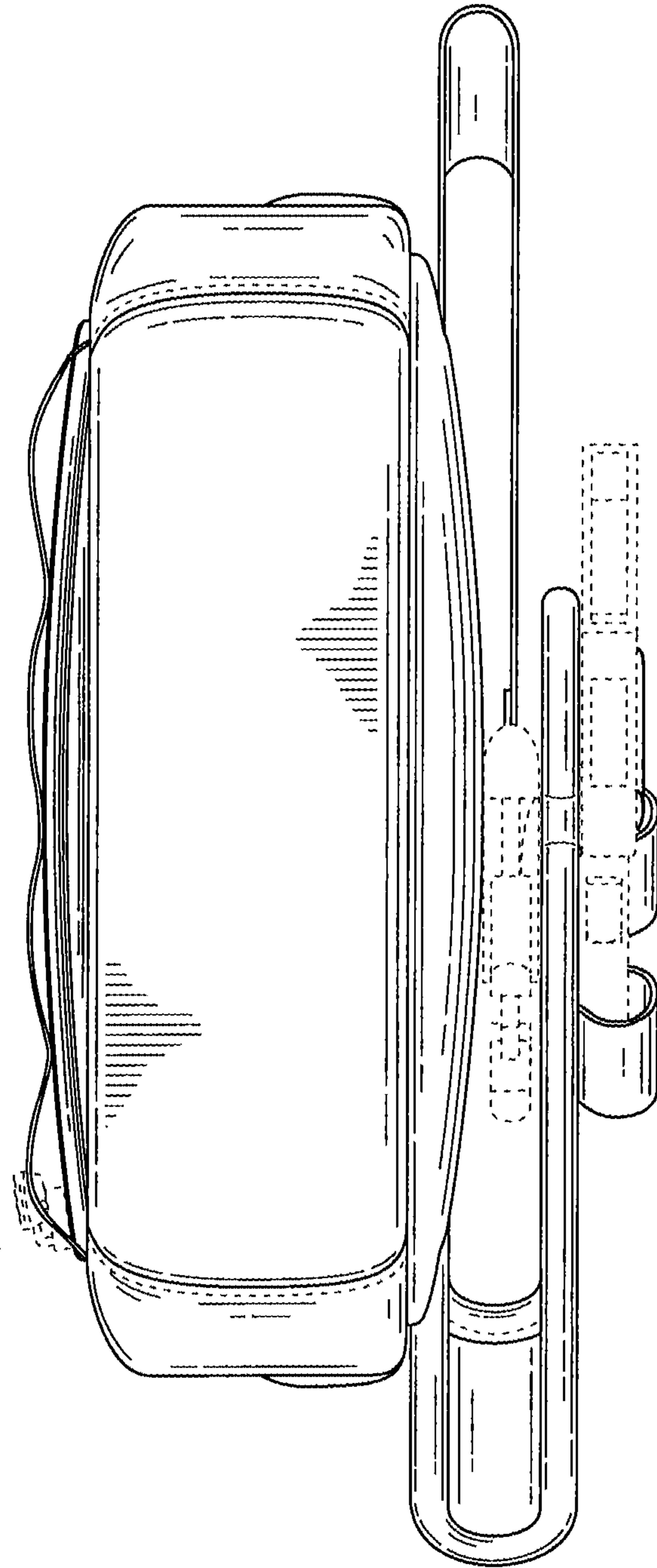

FIG. 7