



US00D880818S

(12) **United States Design Patent**
Eugene

(10) **Patent No.:** **US D880,818 S**
(45) **Date of Patent:** **** Apr. 14, 2020**

- (54) **SHOE**
- (71) Applicant: **Puma SE**, Herzogenaurach (DE)
- (72) Inventor: **Guercy Eugene**, Boston, MA (US)
- (73) Assignee: **PUMA SE**, Herzogenaurach (DE)
- (**) Term: **15 Years**
- (21) Appl. No.: **29/696,859**
- (22) Filed: **Jul. 2, 2019**

Related U.S. Application Data

- (62) Division of application No. 29/634,040, filed on Jan. 18, 2018.
- (51) **LOC (12) Cl.** **02-04**
- (52) **U.S. Cl.**
USPC **D2/902**; D2/943
- (58) **Field of Classification Search**
USPC D2/902, 906, 907, 908, 909, 916, 922,
D2/947, 951, 952, 953, 957, 961, 962;
36/24.5, 25 R, 28, 32 R, 34 R, 67 A, 103
CPC A43B 13/00; A43B 13/02; A43B 13/023;
A43B 13/026; A43B 13/08; A43B 13/10;
A43B 13/04; A43B 13/12
See application file for complete search history.

(56) **References Cited**

U.S. PATENT DOCUMENTS

4,896,441 A *	1/1990	Galasso	A43B 7/1415	36/140
D549,932 S *	9/2007	Rohwer-Kahlmann	D2/902	
D682,530 S *	5/2013	Wilken	D2/972	
D690,490 S *	10/2013	Riddell	D2/951	
D716,025 S *	10/2014	Seo	D2/951	
D730,035 S *	5/2015	Henderson	D2/947	
D731,769 S *	6/2015	Raysse	D2/951	
D738,078 S *	9/2015	Raysse	D2/951	

D740,007 S	10/2015	Lan	
D769,600 S	10/2016	Avar	
D774,288 S *	12/2016	Pina D2/908
D811,701 S	3/2018	Tæstensen	
D815,826 S	4/2018	Kuerbis	
D825,908 S	8/2018	Mancini	
D826,534 S	8/2018	Ammon	
D826,540 S *	8/2018	Petrie D2/973
D827,258 S *	9/2018	Pina D2/916
D838,449 S	1/2019	Michetti	

(Continued)

OTHER PUBLICATIONS

Fenty by Rihanna posted by PUMA posted date unknown, © Shoe Bacca, [online], [site visited Aug. 1, 2019]. Available from Internet, <https://www.shoebacca.com/puma-x-fenty-trainer-mid-190938-01.html> (Year: 2019).*

(Continued)

Primary Examiner — Cynthia Ramirez
Assistant Examiner — Laura H Yu
(74) *Attorney, Agent, or Firm* — Leydig, Voit & Mayer, Ltd.

(57) **CLAIM**

The ornamental design for a shoe, as shown and described.

DESCRIPTION

FIG. 1 is a top left front perspective view of the shoe showing my new design;
FIG. 2 is a front view thereof;
FIG. 3 is a rear view thereof;
FIG. 4 is a right side view thereof;
FIG. 5 is a left side view thereof;
FIG. 6 is a top view thereof; and,
FIG. 7 is a bottom view thereof.
The broken lines in the drawings illustrate portions of the shoe which form no part of the claimed design.

1 Claim, 5 Drawing Sheets

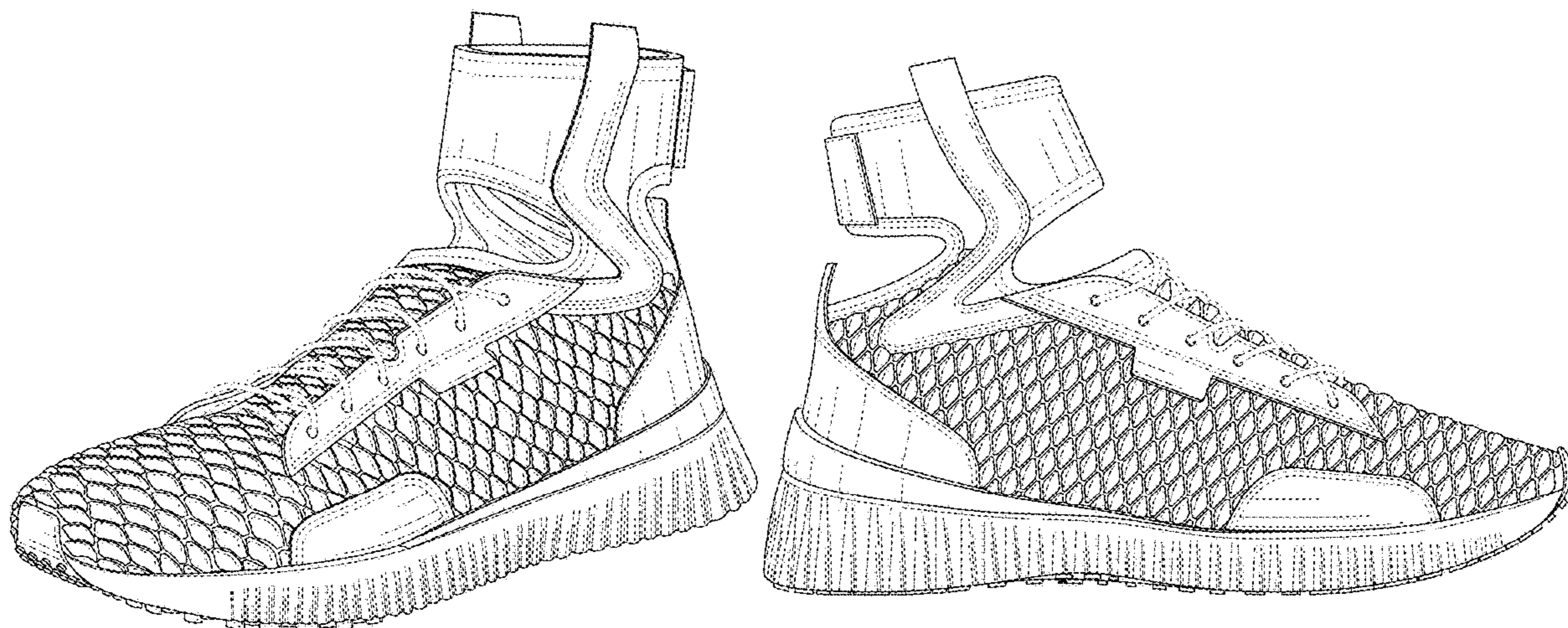

(56)

References Cited

U.S. PATENT DOCUMENTS

D840,649 S 2/2019 De Biase
D844,952 S * 4/2019 Taylor D2/947
D846,851 S * 4/2019 Della Valle D2/947
D858,071 S * 9/2019 Petrie D2/972

OTHER PUBLICATIONS

Mid Geo Fenty by Rihanna posted by PUMA posted review date Aug. 3, 2018, © eBAY, [online], [site visited Aug. 1, 2019]. Available from Internet, <https://www.google.com/shopping/product/15225448142350433452?q=puma+sneakers+with+ankle+strap> (Year: 2018).*

Mid Geo Fenty by Rihanna posted by Shop Zappos posted review date Jan. 25, 2018, © Youtube, [online], [site visited Aug. 1, 2019]. Available from Internet, <https://www.youtube.com/watch?v=69q5mwMt31l> (Year: 2018).*

* cited by examiner

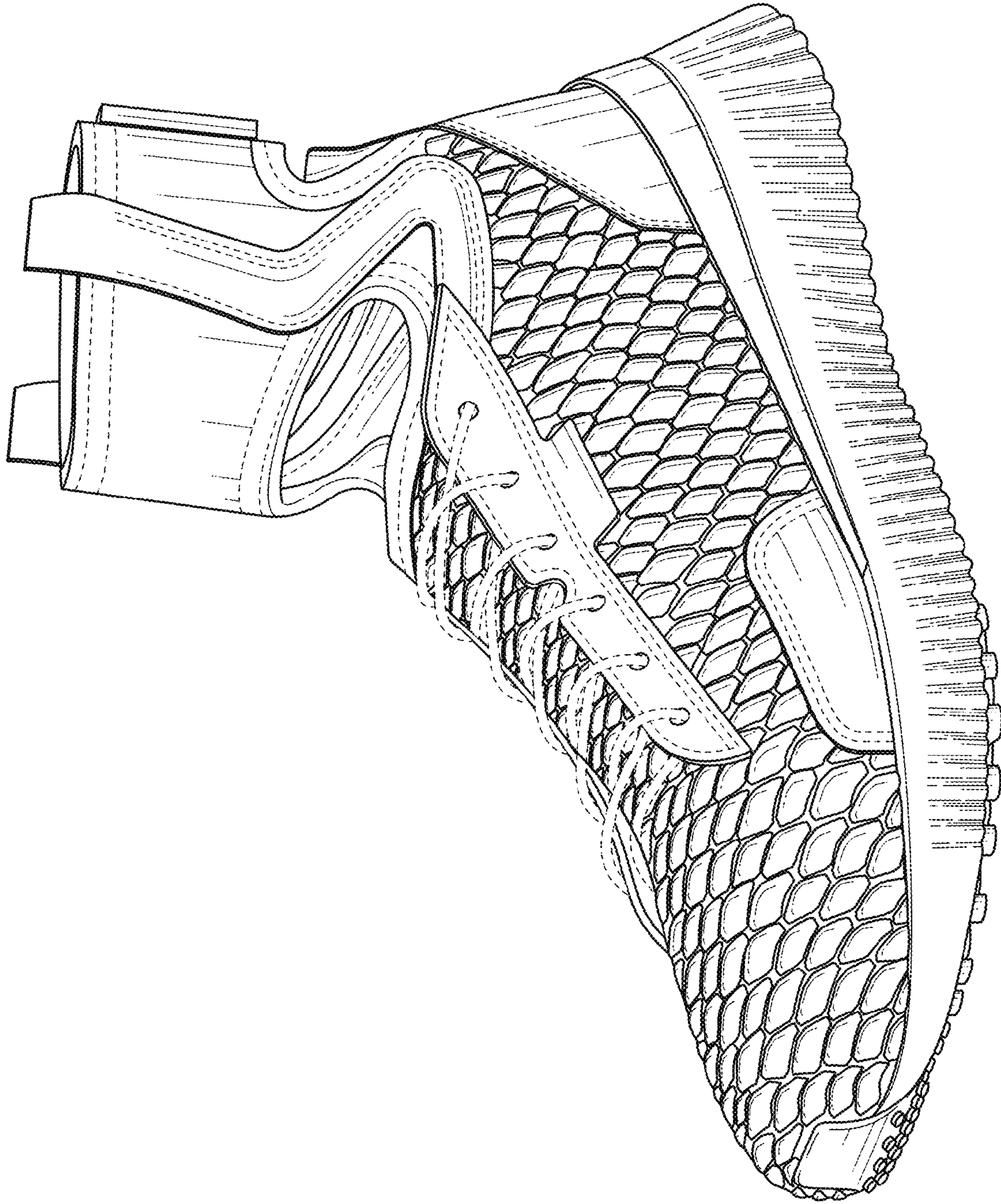

FIG. 1

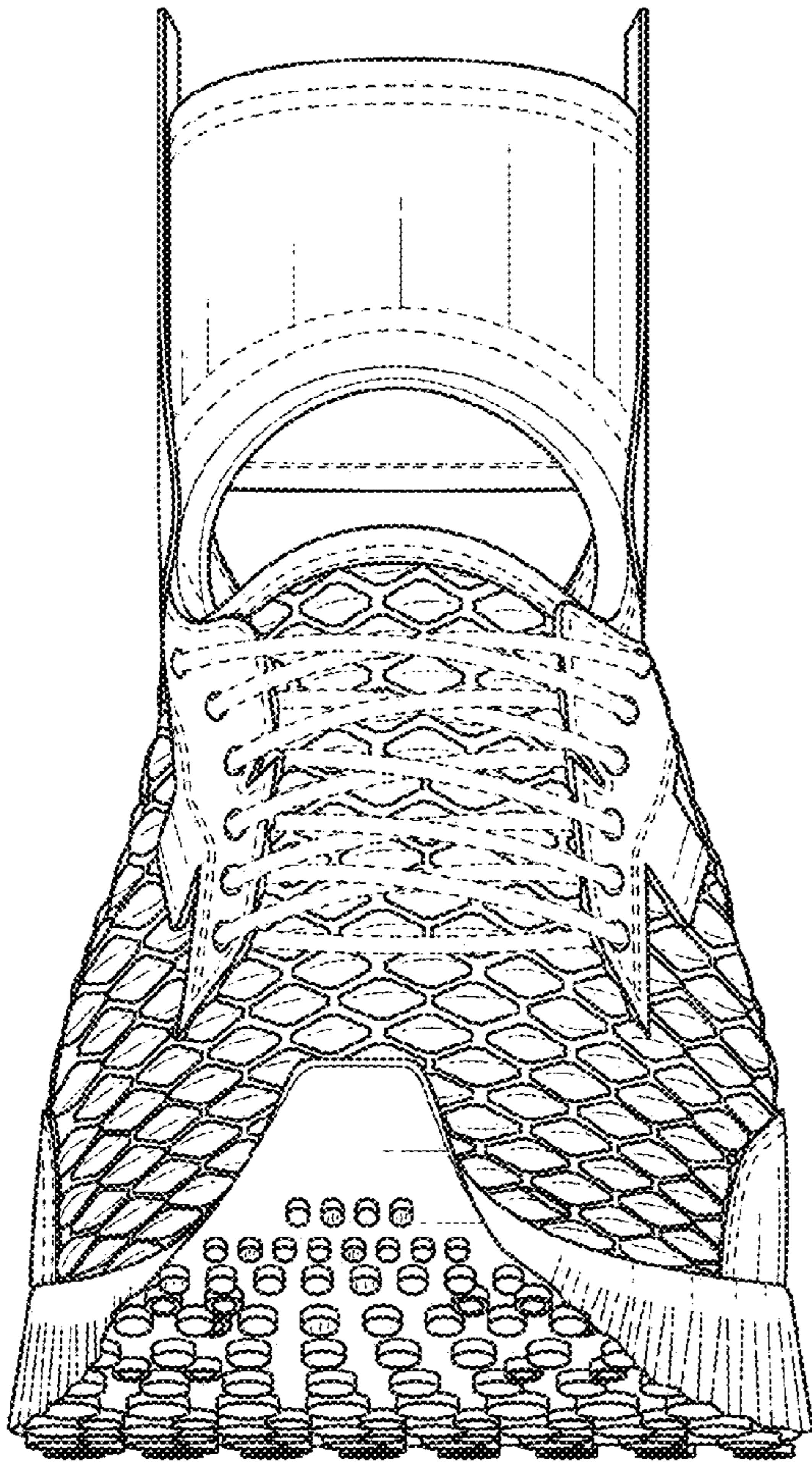

FIG. 2

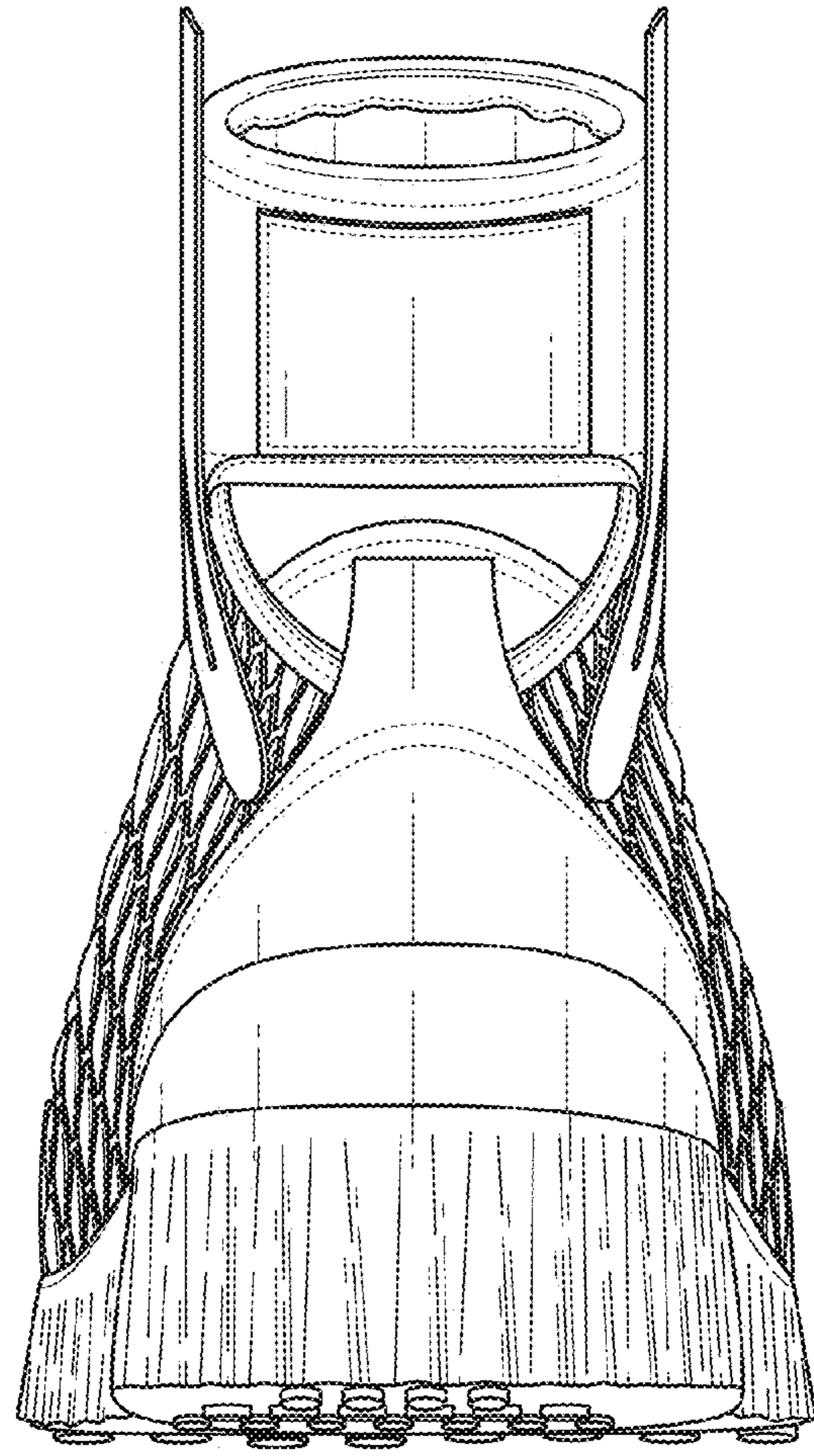

FIG. 3

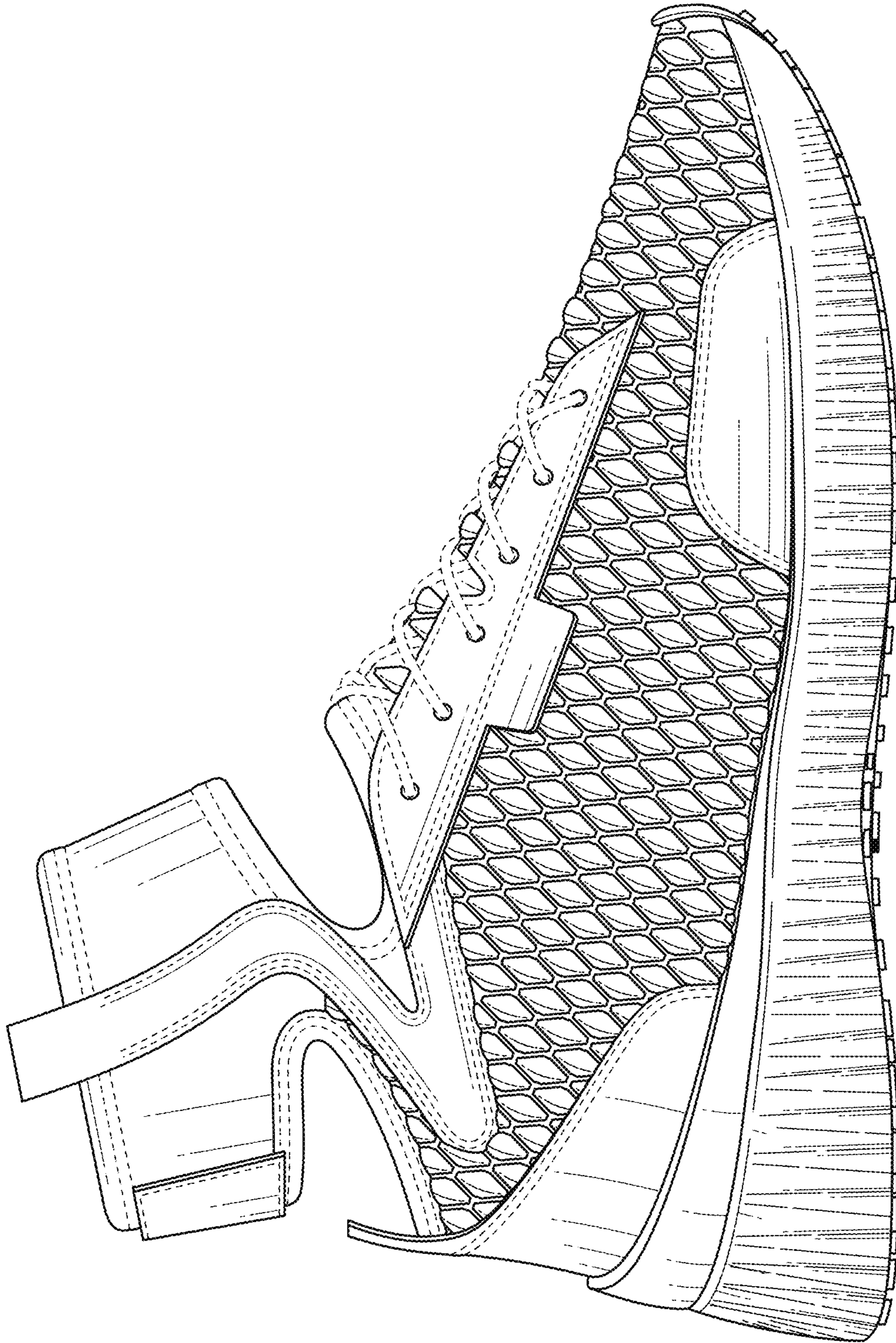

FIG. 4

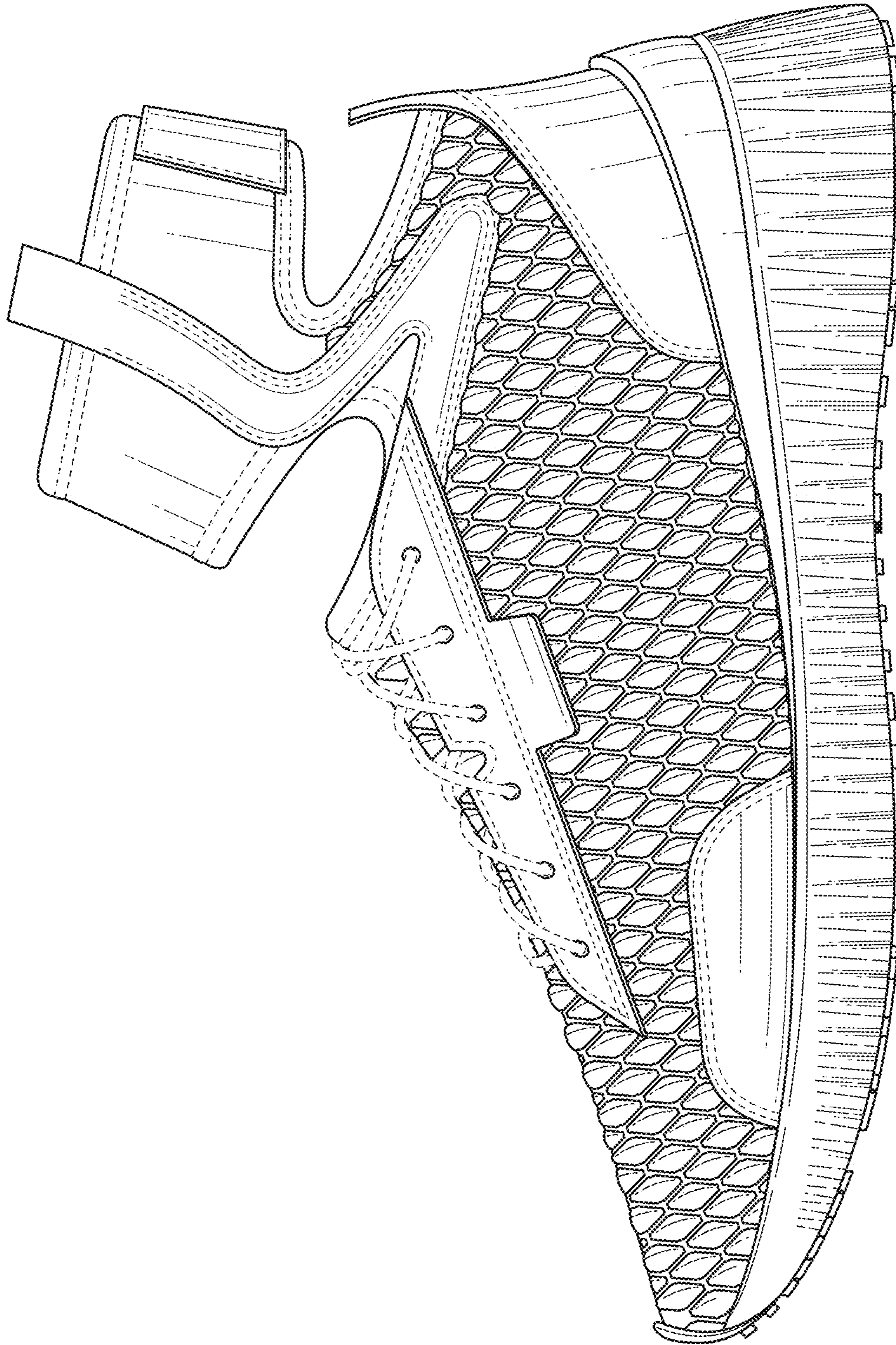

FIG. 5

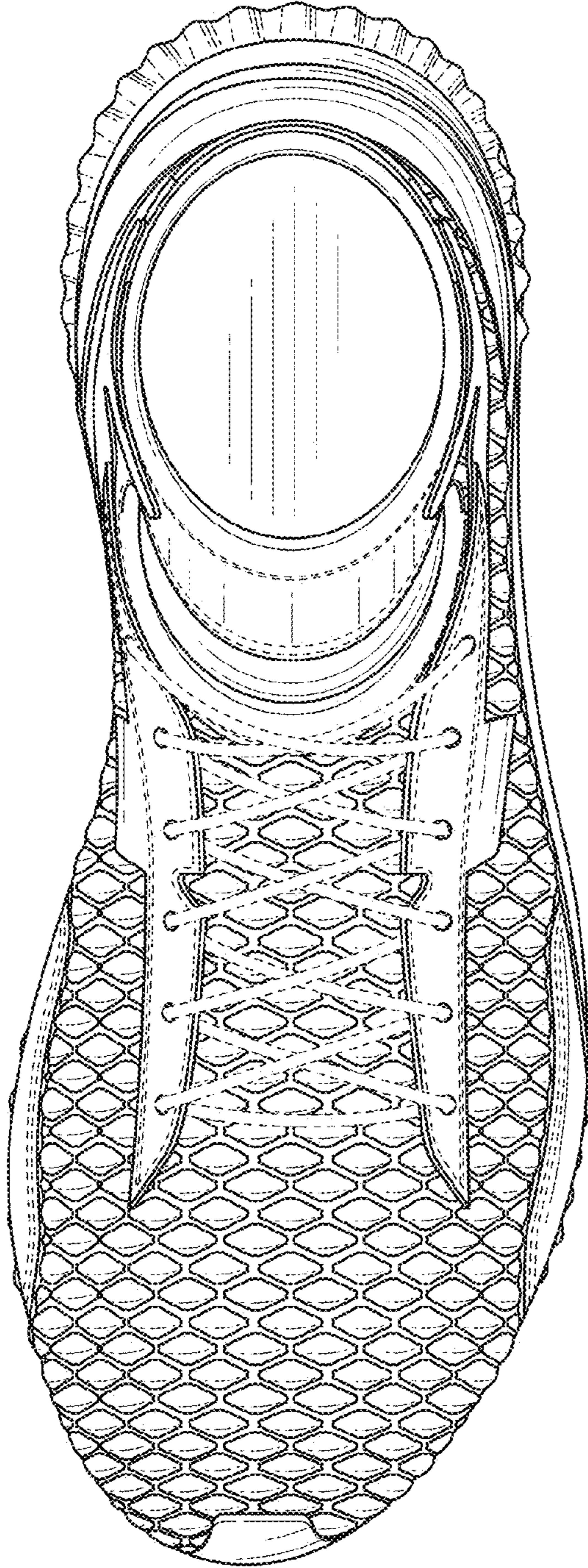

FIG. 6

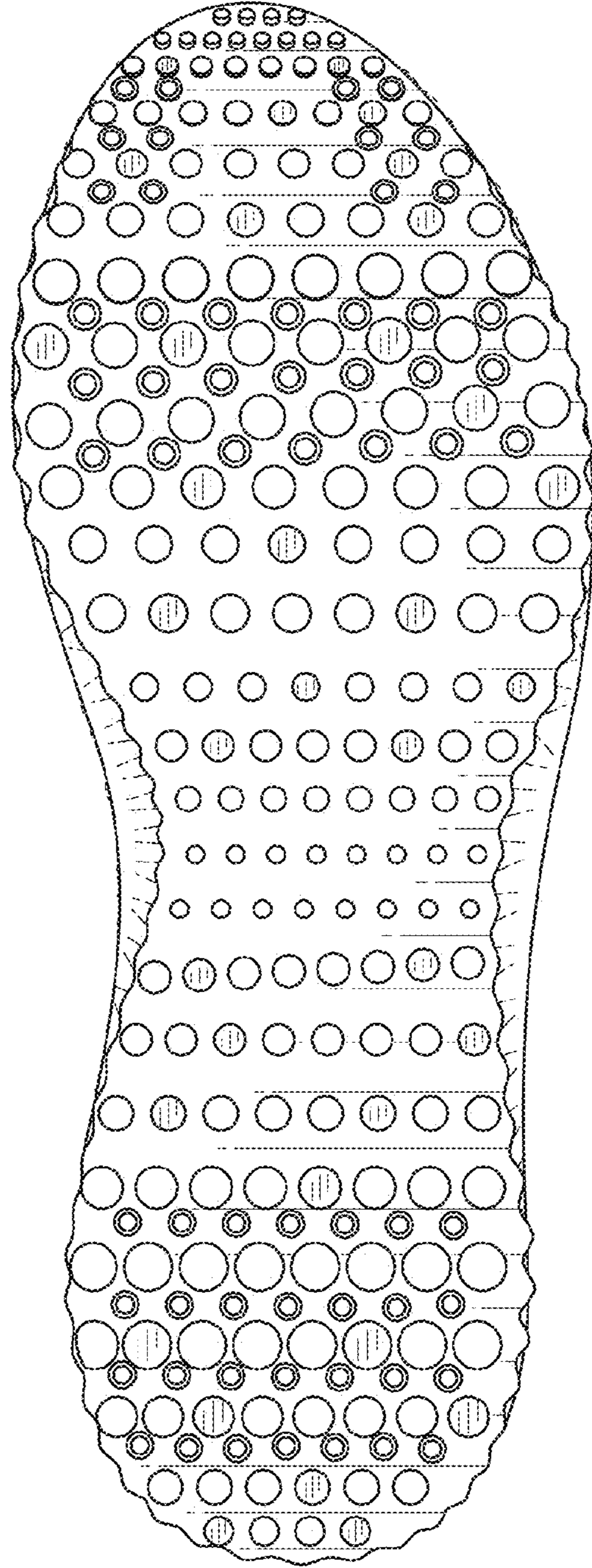

FIG. 7