



US00D880811S

(12) **United States Design Patent** (10) **Patent No.:** **US D880,811 S**
Butts et al. (45) **Date of Patent:** **** Apr. 14, 2020**

(54) **GLOVE WITH PALM STITCHING**

(71) Applicant: **Big Time Products, LLC**, Rome, GA (US)
(72) Inventors: **Mark Lee Butts**, Atlanta, GA (US); **Jing Li**, Shanghai (CN); **Christopher Matthew Weed**, Marietta, GA (US); **James Blake Fievet**, Decatur, GA (US); **Jarrold Thomas Streng**, Atlanta, GA (US)
(73) Assignee: **BIG TIME PRODUCTS, LLC**, Rome, GA (US)

(**) Term: **15 Years**

(21) Appl. No.: **29/660,116**

(22) Filed: **Aug. 17, 2018**

(51) **LOC (12) Cl.** **02-06**

(52) **U.S. Cl.**
USPC **D2/617**

(58) **Field of Classification Search**
USPC D2/617, 621, 619; D29/117.1, 113, D29/117.2
CPC A41D 19/00
See application file for complete search history.

(56) **References Cited**

U.S. PATENT DOCUMENTS

D589,679 S *	4/2009	Rolfe	D2/617
D779,781 S *	2/2017	Votel	D2/617
D824,638 S *	8/2018	Jie	D2/617
D824,639 S *	8/2018	Jie	D2/617
D840,604 S *	2/2019	Iacono	D29/117.1
D844,903 S *	4/2019	Iacono	D29/113
2013/0152272 A1 *	6/2013	Schultz	G06F 3/014 2/161.6

OTHER PUBLICATIONS

Aubuchon Hardware Store Youngstown Glove, posted at hardwarestore.com, posting date not given, [online], [site visited Nov. 22, 2019]. Available from Internet, URL: <https://www.hardwarestore.com/youngstown-glove-co-pro-xt-gloves-medium.html> (Year: 2019).*

(Continued)

Primary Examiner — George D. Kirschbaum

Assistant Examiner — Maria J Edwards

(74) *Attorney, Agent, or Firm* — Thompson Hine L.L.P.

(57) **CLAIM**

The ornamental design for a glove with palm stitching, as shown and described.

DESCRIPTION

FIG. 1 is a back perspective view of a glove with palm stitching, showing our new design; FIG. 2 is a front perspective view thereof; FIG. 3 is a back elevation view thereof; FIG. 4 is a front elevation view thereof; FIG. 5 is a right side elevation view thereof; FIG. 6 is a left side elevation view thereof; FIG. 7 is a top plan view thereof; and, FIG. 8 is a bottom view thereof.

While a right-handed glove is shown and claimed, the right-handed glove is typically sold with a left-handed glove having a design that is a mirror image of the right-handed glove.

The dash-dot-dash lines shown in the figures illustrate portions of the glove with palm stitching that form no part of the claimed design.

The broken lines shown in the figures represent stitching and form part of the claimed design.

1 Claim, 7 Drawing Sheets

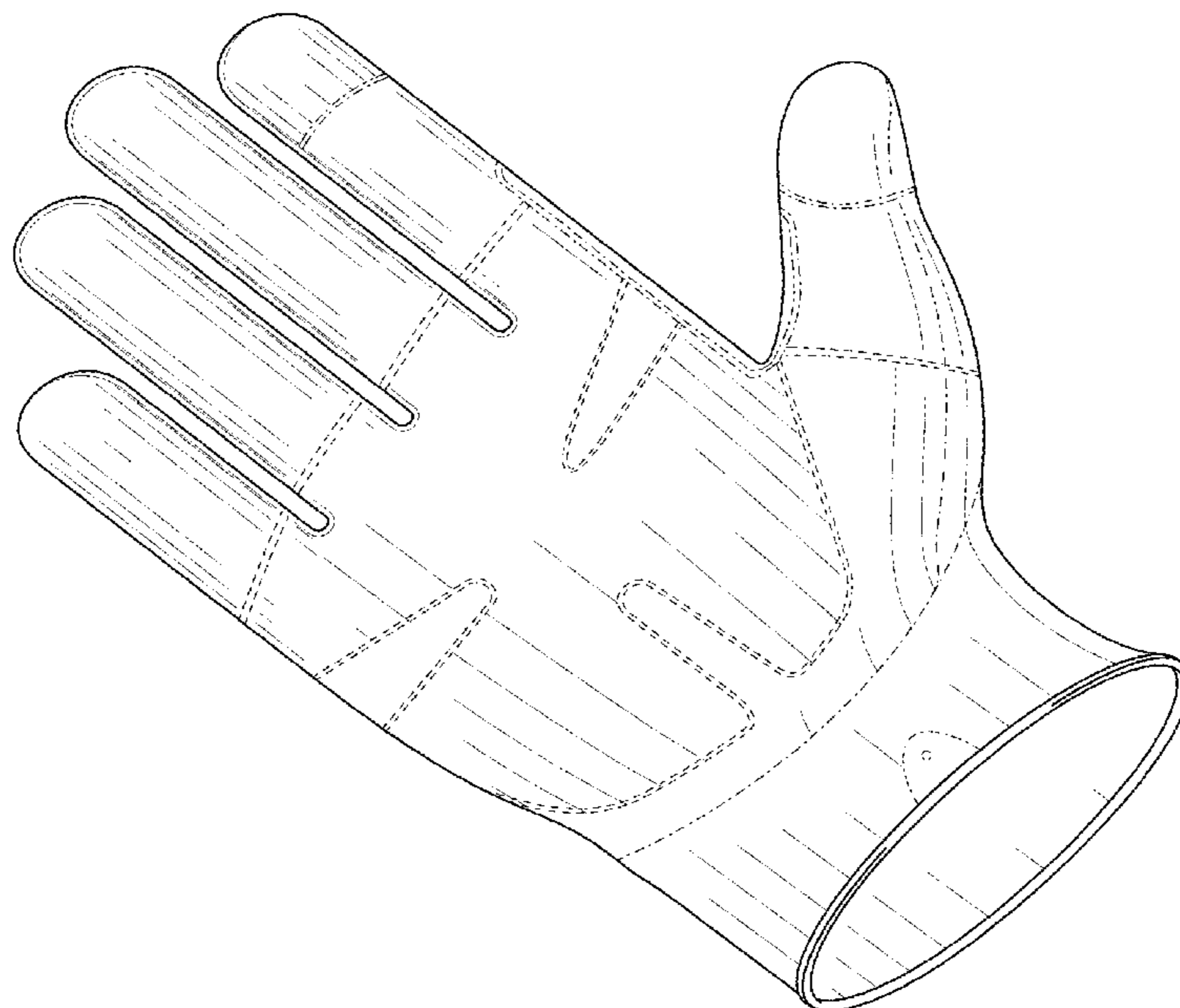

(56)

References Cited

OTHER PUBLICATIONS

Big Time Products Pigskin Gloves, posted at amazon.com, posting date not given, [online], [site visited Nov. 22, 2019]. Available from Internet, URL: <https://www.amazon.com/big-time-products-llc-99518-23/dp/B07JZ4Q4WN> (Year: 2019).*

DeWalt All Purpose Work Gloves, posted at ebay.com, posting date not given, [online], [site visited Nov. 22, 2019]. Available from Internet, URL: <https://www.ebay.com/itm/DeWalt-All-Purpose-Synthetic-Leather-Palm-Work-Gloves-/383056738777> (Year: 2019).*

Thumb Saddle, <https://www.homedepot.com/p/Firm-Grip-Utility-Large-Multi-Color-Synthetic-Leather-Glove-3-Pack-33102-96/306085589>, Aug. 22, 2018.

Thumb Saddle, <https://www.homedepot.com/p/Husky-Large-Hi-Dex-Leather-Glove-HK86007-L/300984902>, May 17, 2017.

Chamfered Strap, <https://www.homedepot.com/p/Husky-Medium-Heavy-Duty-Glove-67811-06/302677959>, May 1, 2018.

Chamfered Strap, <https://www.homedepot.com/p/Husky-Large-Light-Duty-Glove-67807-06/302751269>, Jul. 4, 2018.

Chamfered Strap, <https://www.amazon.com/Vgo-Dexterity-Anti-vibration-Anti-abrasion-Touchscreen/dp/B0725QH9P1>, Sep. 24, 2017.

Chanfered Strap, https://www.amazon.com/125L-Resistant-Dexterity-Stretchable-Excellent/dp/B0002YPZLI/ref=sr_1_4?le=UTF8&gid=1532313123&sr=8-4&keywords=work+gloves+men, Apr. 16, 2013.

Gel Prod With Index Finger Seam on Back Side, <https://www.homedepot.com/p/Firm-Grip-Large-Gel-Pro-Carpenter-Work-Gloves-55232-06/300908999>, May 19, 2017.

* cited by examiner

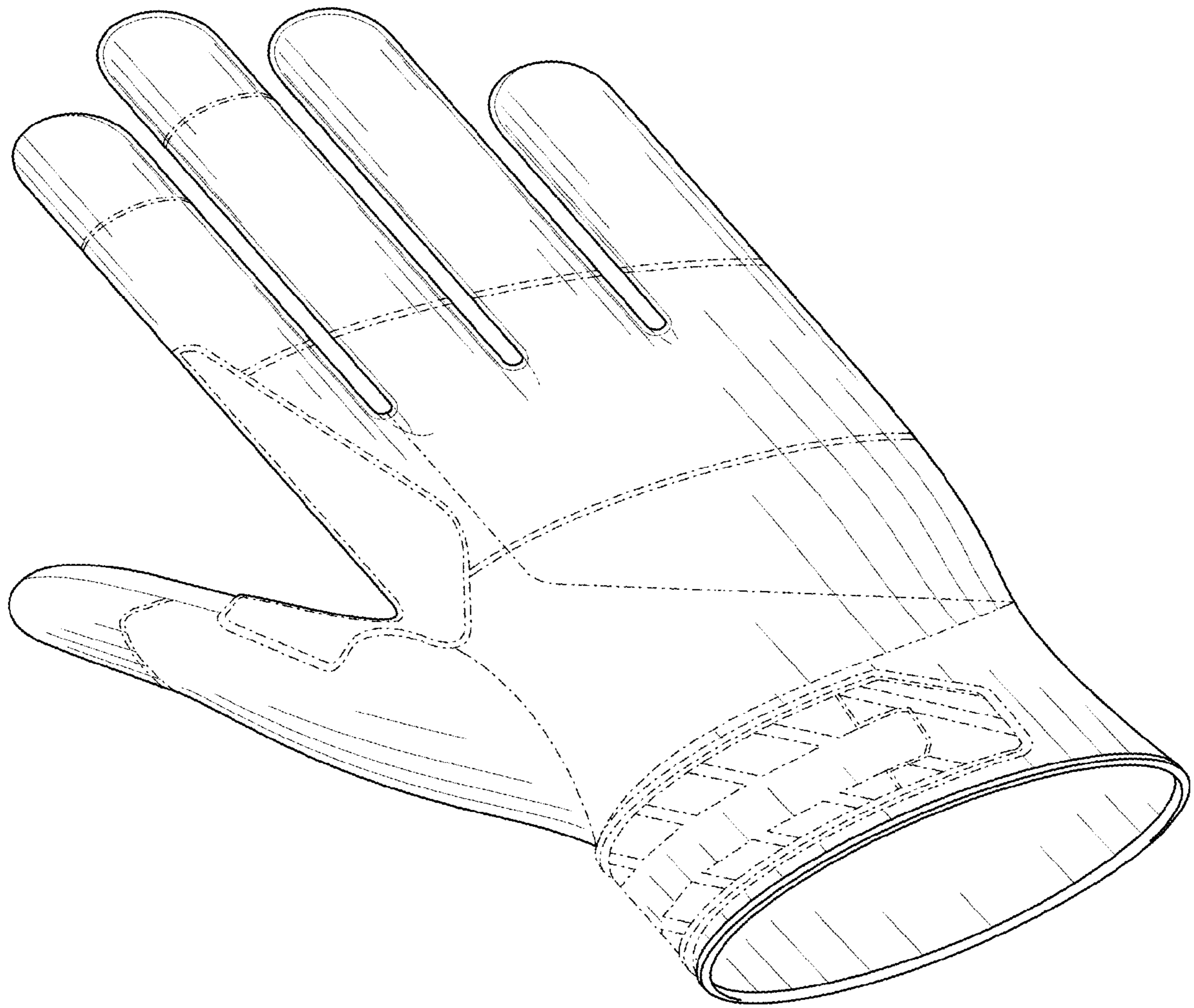

FIG. 1

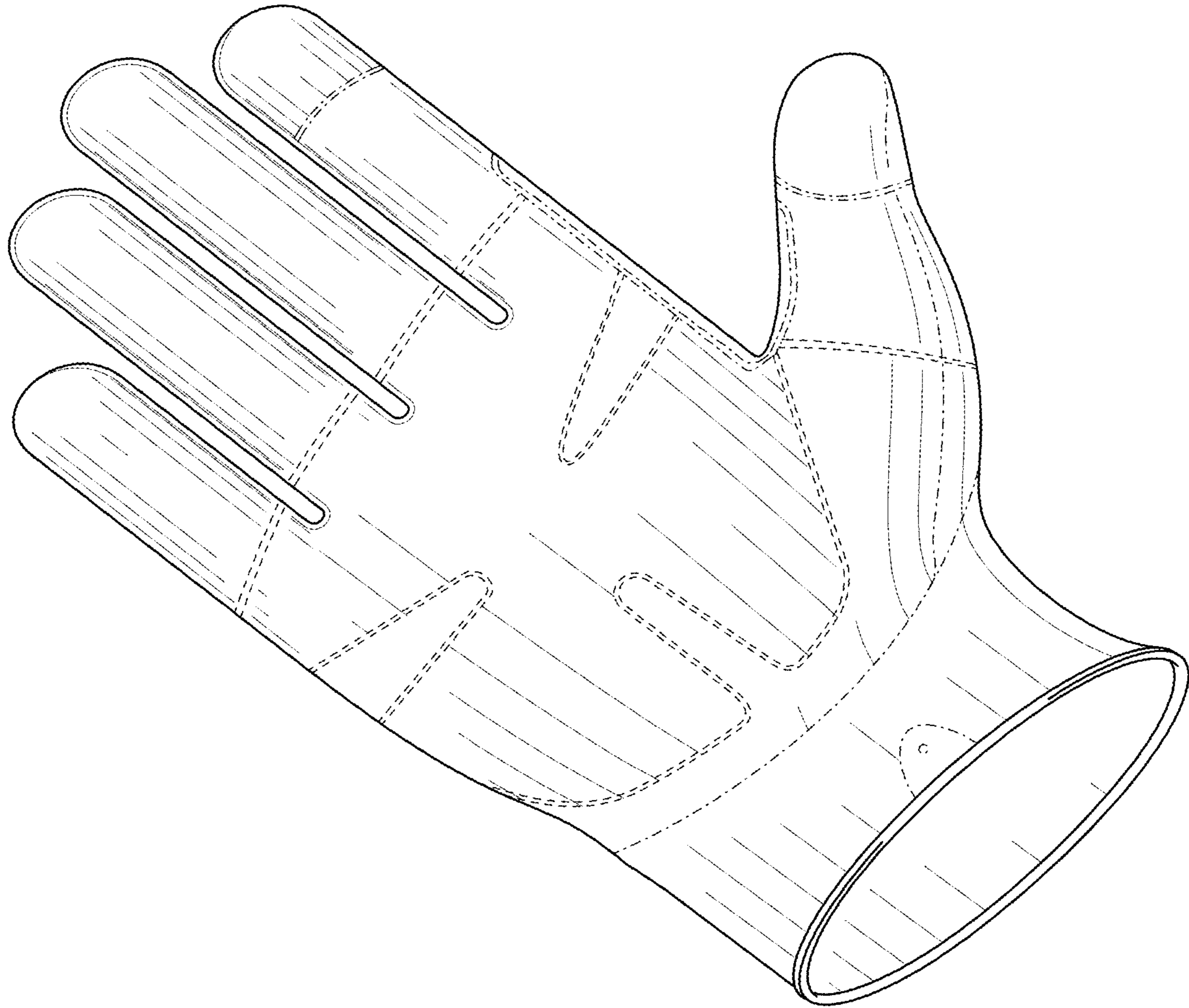

FIG. 2

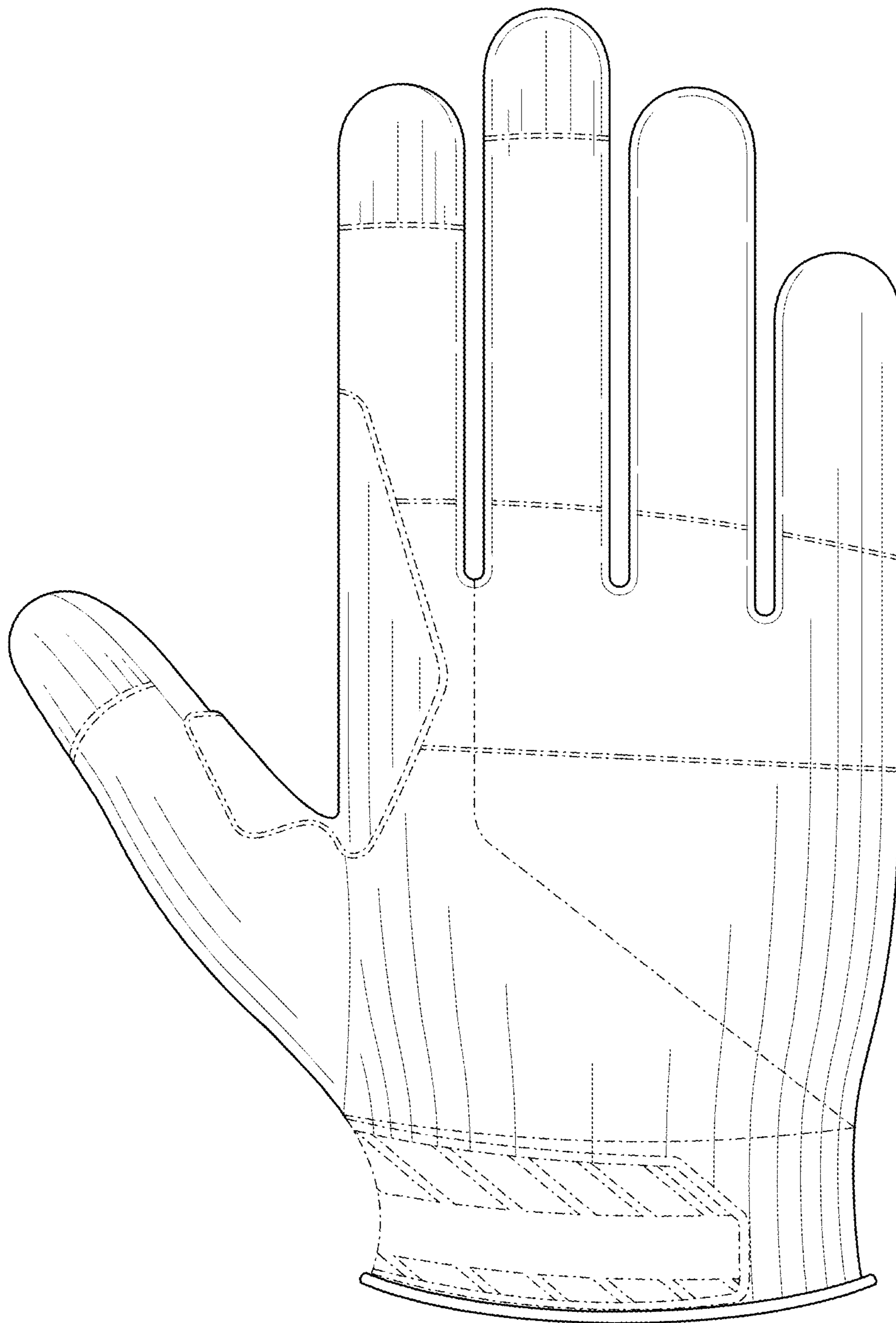

FIG. 3

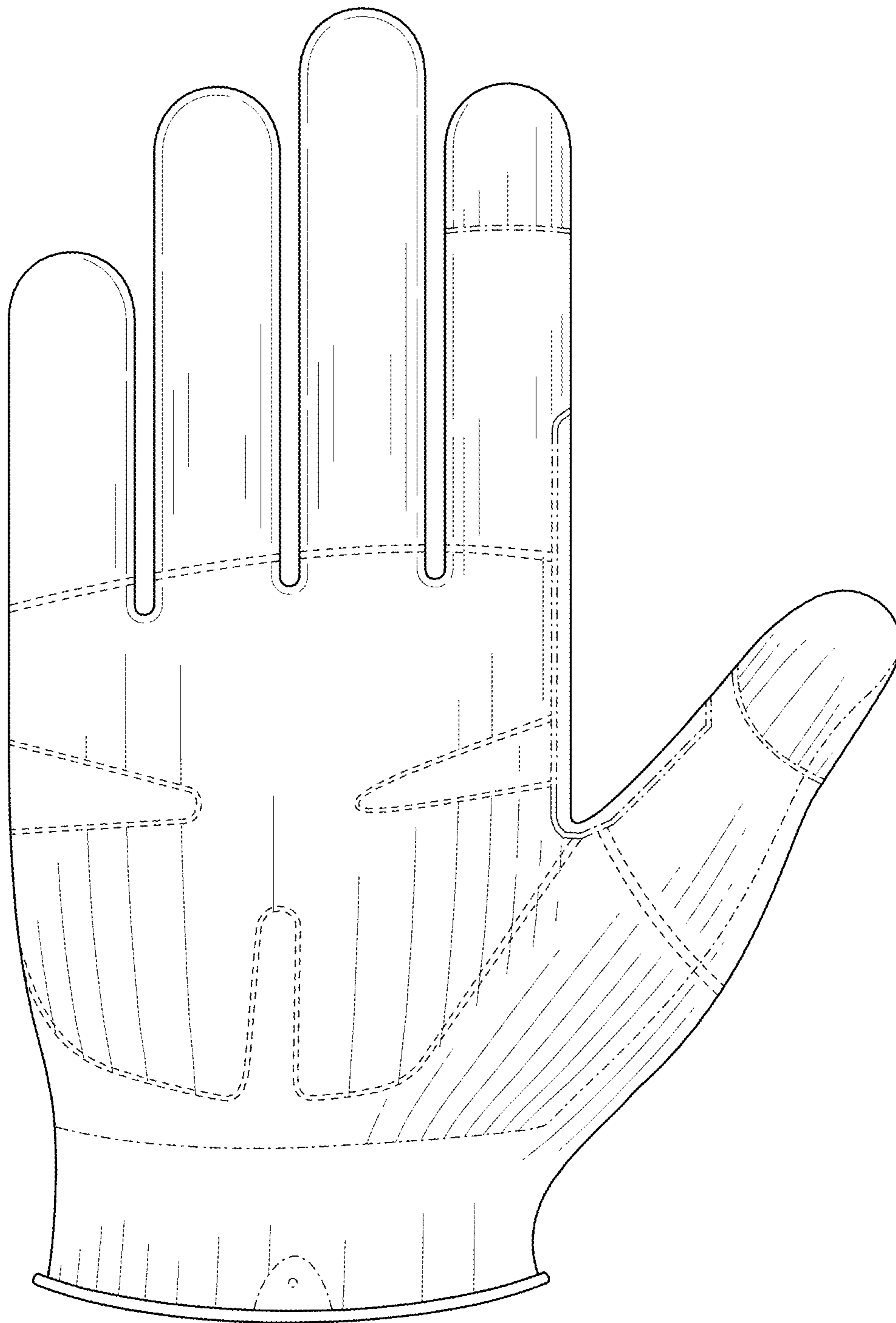

FIG. 4

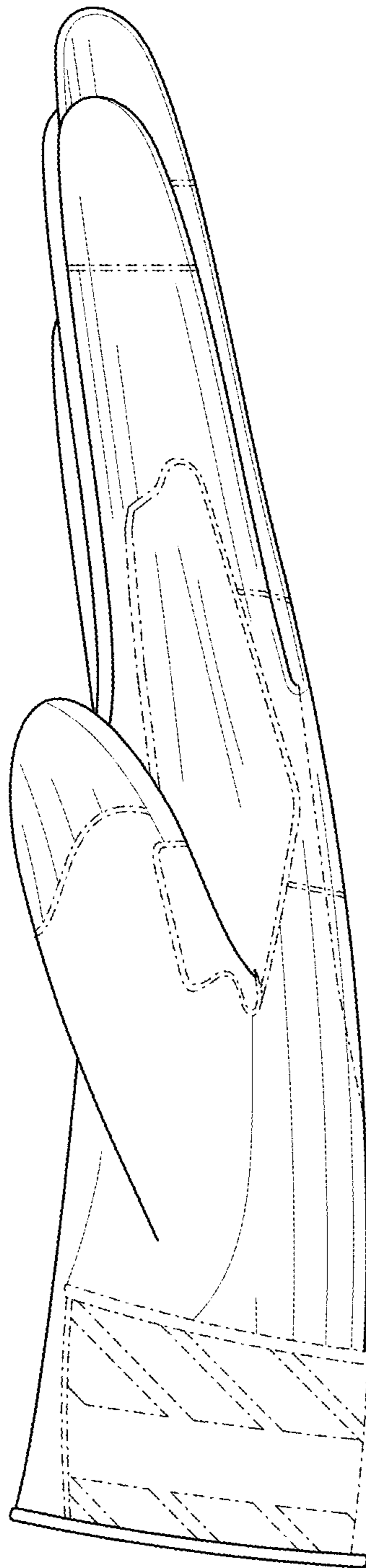

FIG. 5

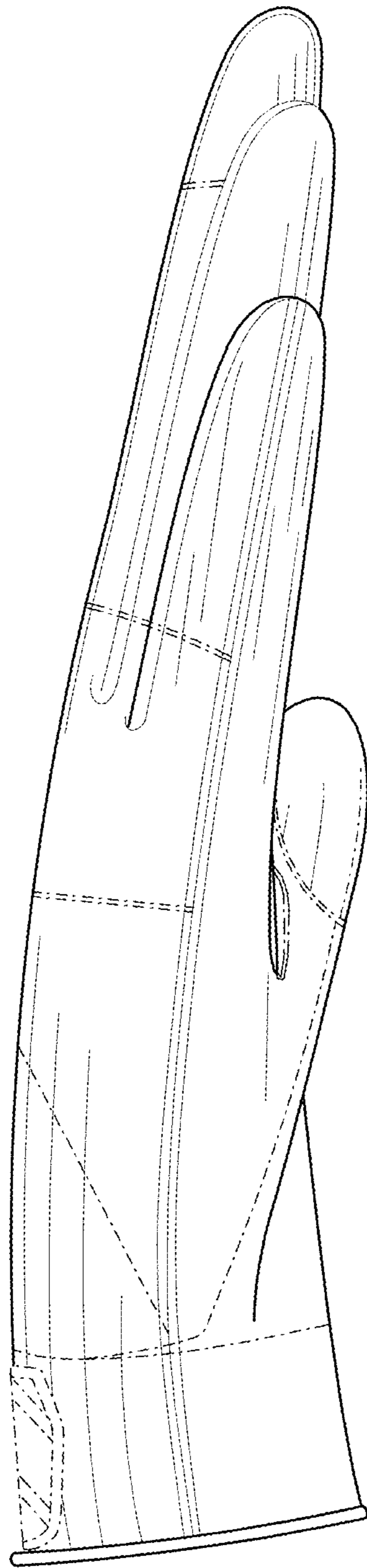

FIG. 6

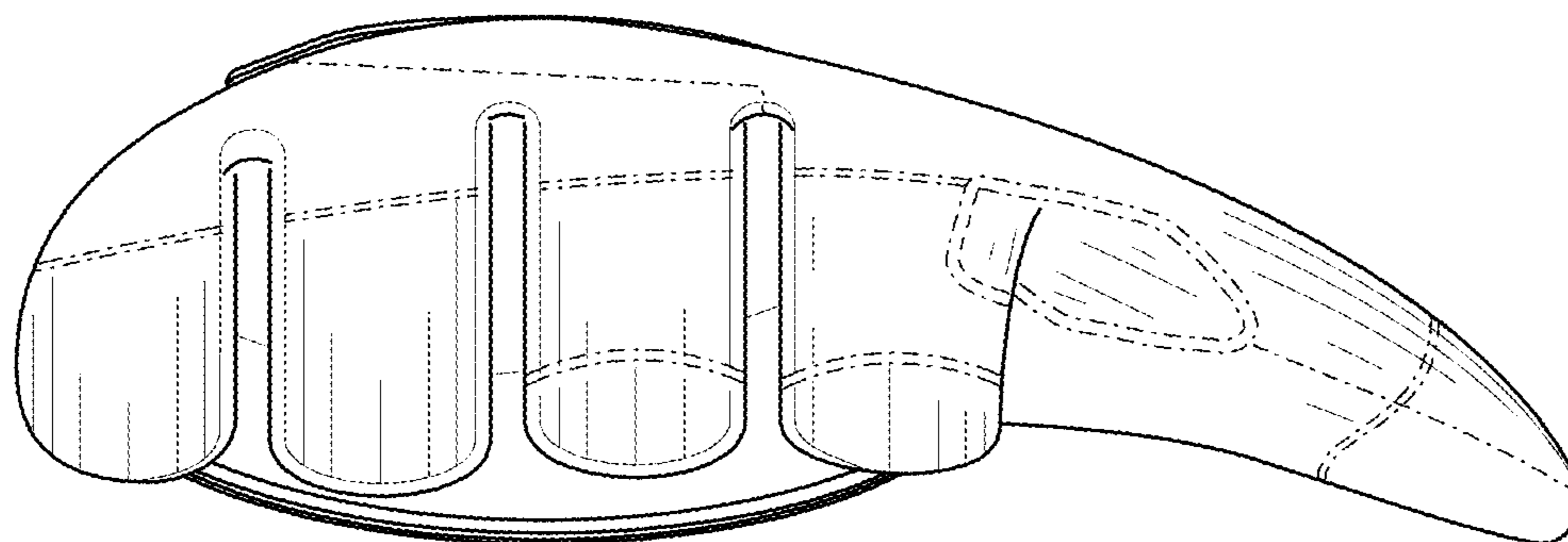

FIG. 7

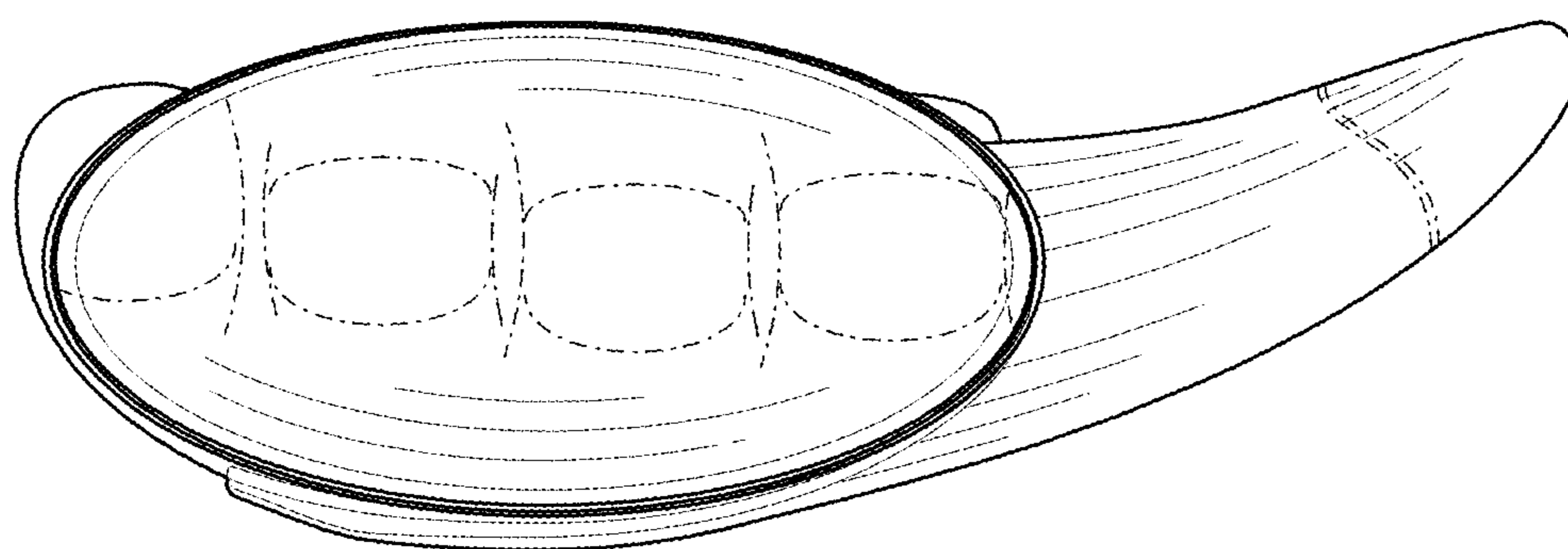

FIG. 8