



US00D880778S

(12) **United States Design Patent** (10) **Patent No.:** **US D880,778 S**  
**Martinez** (45) **Date of Patent:** **\*\* \*Apr. 7, 2020**

- (54) **SHEET OF MATERIAL FOR A WEARABLE ITEM SUCH AS A GARMENT, VEST OR SHIRT**
- (71) Applicant: **Safariland, LLC**, Jacksonville, FL (US)
- (72) Inventor: **Ulysses Martinez**, Lakewood, CA (US)
- (73) Assignee: **Safariland, LLC**, Jacksonville, FL (US)
- (\* ) Notice: This patent is subject to a terminal disclaimer.
- (\*\*) Term: **15 Years**
- (21) Appl. No.: **29/654,720**
- (22) Filed: **Jun. 27, 2018**

**Related U.S. Application Data**

- (62) Division of application No. 29/543,925, filed on Oct. 29, 2015, now Pat. No. Des. 822,285.
- (51) **LOC (12) Cl.** ..... **29-02**
- (52) **U.S. Cl.**  
USPC ..... **D29/101.4; D2/750**
- (58) **Field of Classification Search**  
USPC ..... D29/100, 101, 101.2, 101.3, 101.4, 122, D29/124; D2/626, 829, 830, 860, 750;  
(Continued)

(56) **References Cited**

**U.S. PATENT DOCUMENTS**

- 3,917,135 A 11/1975 Christensen
  - 5,031,244 A 7/1991 Inagaki
- (Continued)

**OTHER PUBLICATIONS**

“Perforated Metal” p. 26 (JPO ID No. HC05005929) collected by the JPO on Mar. 19, 1993.

(Continued)

*Primary Examiner* — Randall H Gholson  
(74) *Attorney, Agent, or Firm* — Kane Kessler, P.C.; Paul E. Szabo

(57) **CLAIM**

The ornamental design for a sheet of material for a wearable item such as a garment, vest or shirt, as shown.

**DESCRIPTION**

FIG. 1 is a perspective view of a sheet of material for a wearable item such as a garment, vest or shirt that is a first embodiment of the invention, with molle slits on the front area of the wearable item;

FIG. 2 is a front elevational view of the wearable item of FIG. 1;

FIG. 3 is a back elevational view of the wearable item of FIG. 1;

FIG. 4 is a left side elevational view of the wearable item of Figure 1;

FIG. 5 is a right side elevational view of the wearable item of FIG. 1;

FIG. 6 is a top plan view of the wearable item of FIG. 1;

FIG. 7 is a bottom plan view of the wearable item of FIG. 1;

FIG. 8 is a perspective view of a sheet of material for a wearable item such as a garment, vest or shirt that is a second embodiment of the invention, with molle slits on the back area of the wearable item;

FIG. 9 is a front elevational view of the wearable item of FIG. 8;

FIG. 10 is a back elevational view of the wearable item of FIG. 8;

FIG. 11 is a left side elevational view of the wearable item of FIG. 8;

FIG. 12 is a right side elevational view of the wearable item of FIG. 8;

FIG. 13 is a top plan view of the wearable item of FIG. 8; and,

FIG. 14 is a bottom plan view of the wearable item of FIG. 8.

The material shown in broken lines is environment and forms no part of the claimed design.

**1 Claim, 12 Drawing Sheets**

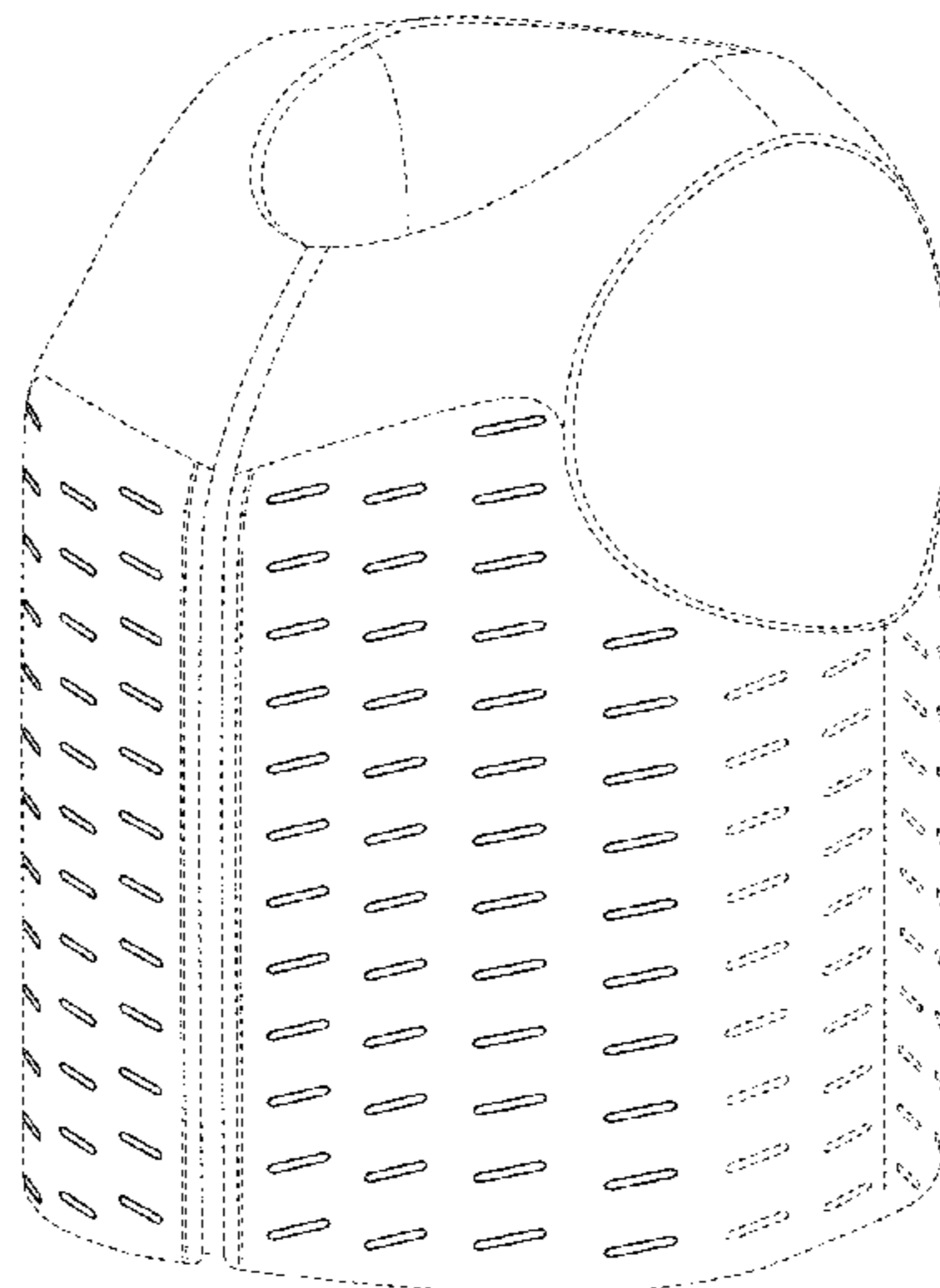

# US D880,778 S

Page 2

(58) **Field of Classification Search**

USPC ..... 362/108; D21/805; 441/88, 106, 108,  
441/111, 117; 182/3; 2/48, 51, 92, 102,  
2/103, 105, 913, 914, 915; D5/57  
CPC ..... A41D 1/00; A45F 3/00  
See application file for complete search history.

8,370,962 B2 2/2013 McBride et al.  
D689,262 S 9/2013 Passman  
D696,029 S 12/2013 Seyler  
8,608,041 B1 12/2013 Adkisson  
D701,020 S \* 3/2014 Passman ..... D2/829  
D732,838 S 6/2015 Seitzinger  
9,365,323 B1 6/2016 Cobler  
D760,996 S 7/2016 Yoo  
D762,346 S 8/2016 Lomax  
9,521,897 B2 12/2016 Thompson  
2007/0079416 A1 4/2007 Carlson  
2012/0180184 A1 7/2012 Crye  
2015/0189977 A1 7/2015 Thompson

(56) **References Cited**

U.S. PATENT DOCUMENTS

D430,734 S 9/2000 Bredendick  
D453,055 S 1/2002 Ode  
D466,702 S \* 12/2002 Carlson ..... D5/1  
6,874,163 B2 4/2005 Marshall  
7,200,871 B1 4/2007 Carlson  
7,448,115 B2 11/2008 Howell et al.  
7,644,449 B2 1/2010 Hellweg  
D653,430 S 2/2012 Pouches  
D662,325 S 6/2012 Wong

OTHER PUBLICATIONS

Japanese Appln. No. 2016-022244 Office Action dated Jan. 30,  
2017.

\* cited by examiner

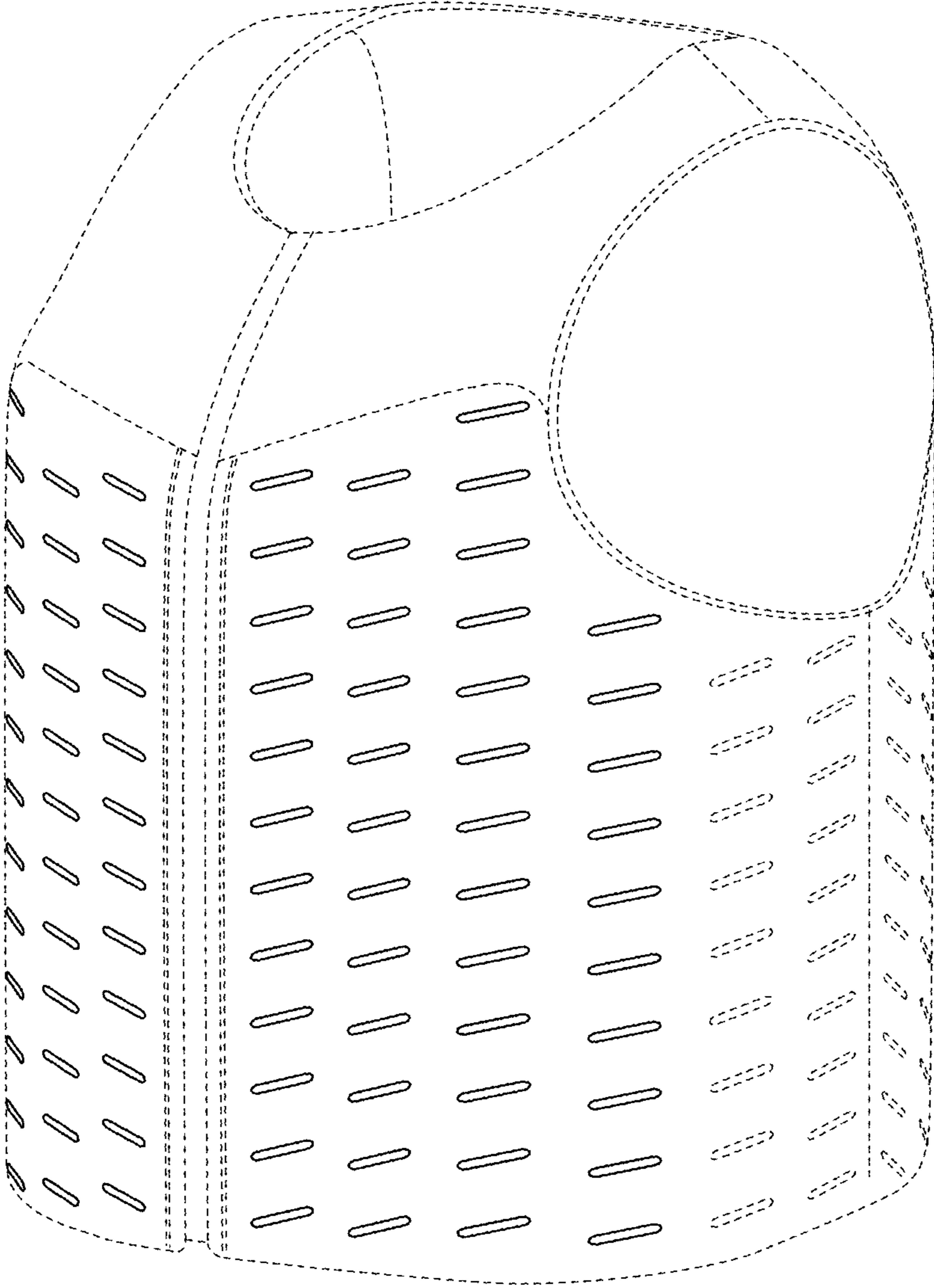

**FIG. 1**

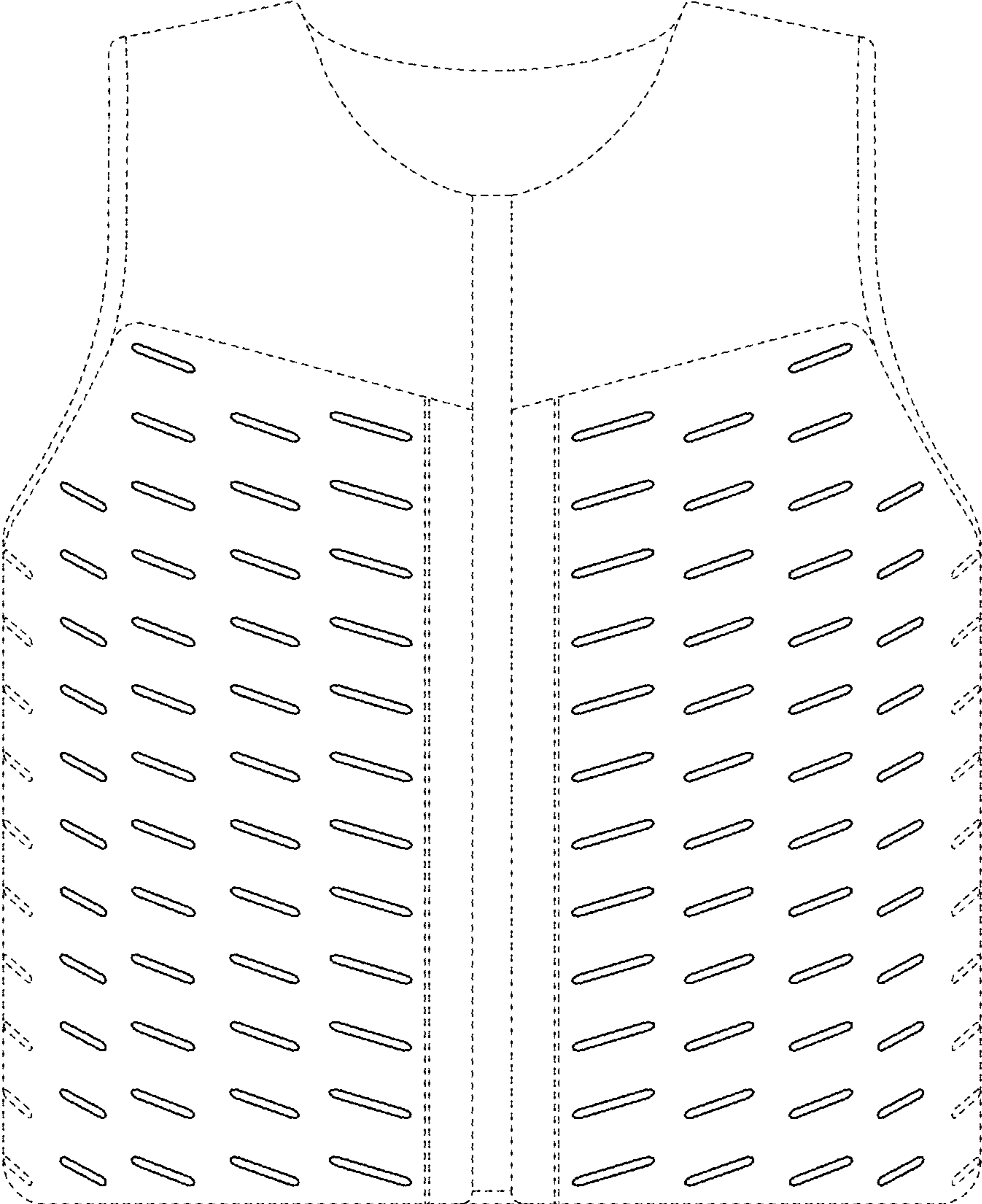
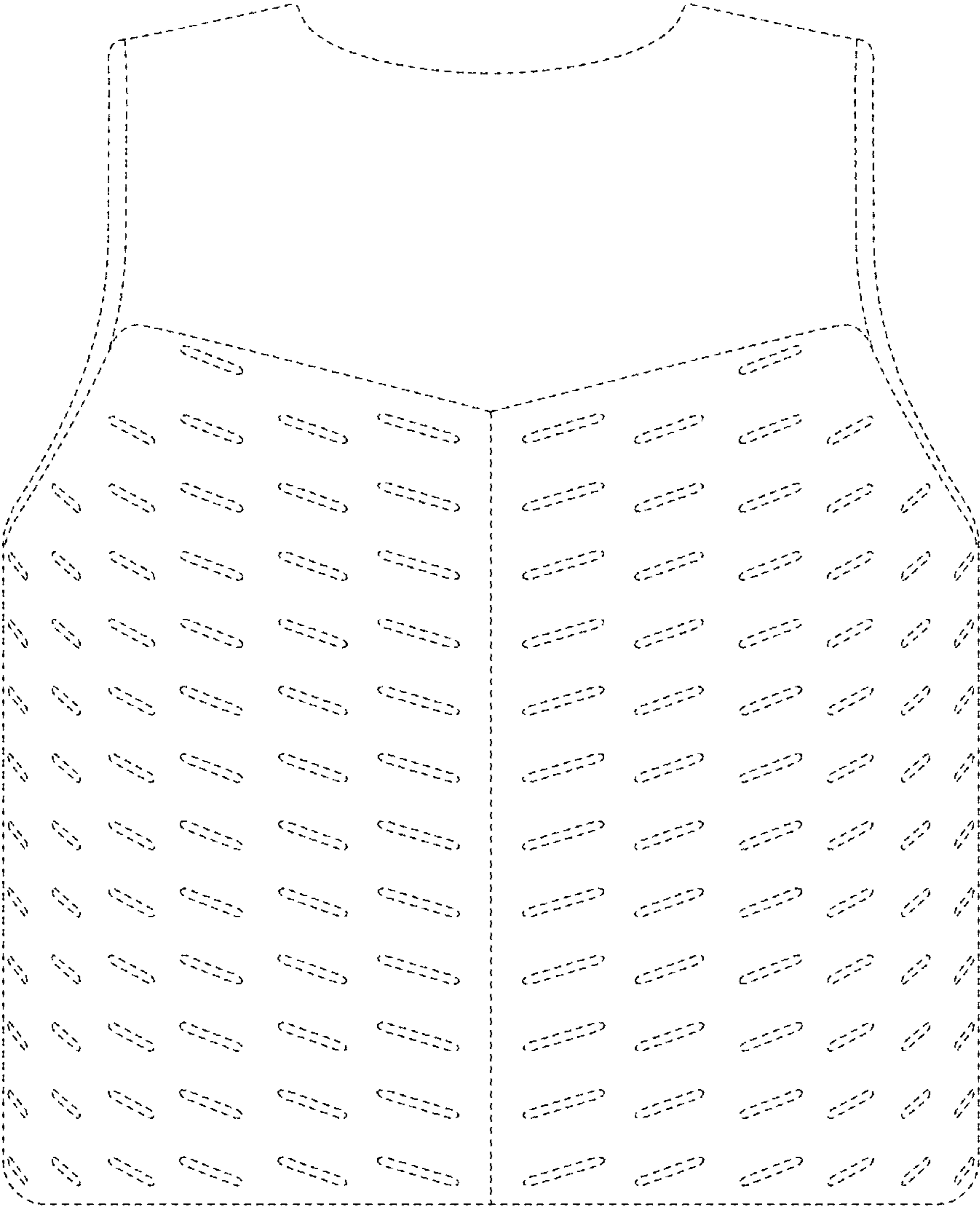

FIG. 2





**FIG. 3**

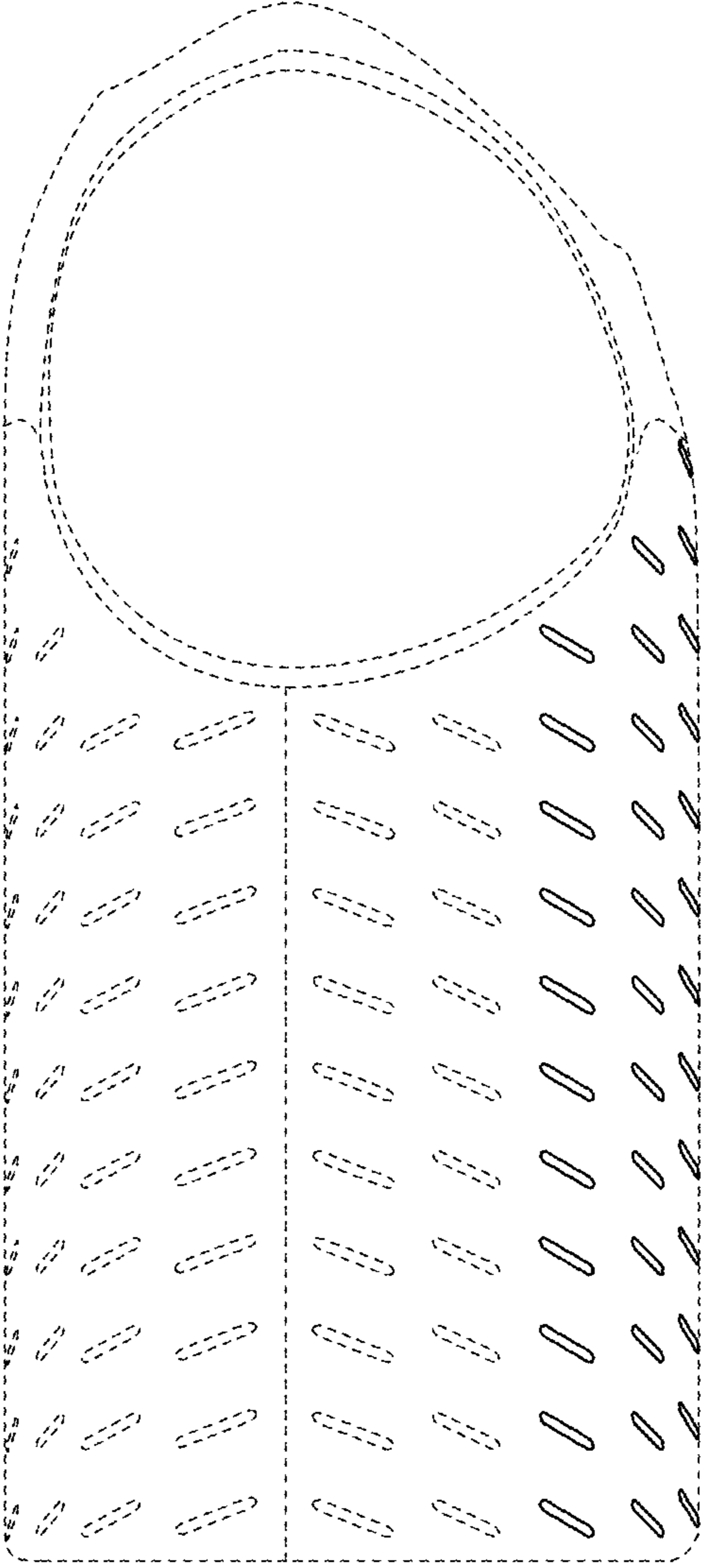

FIG. 4

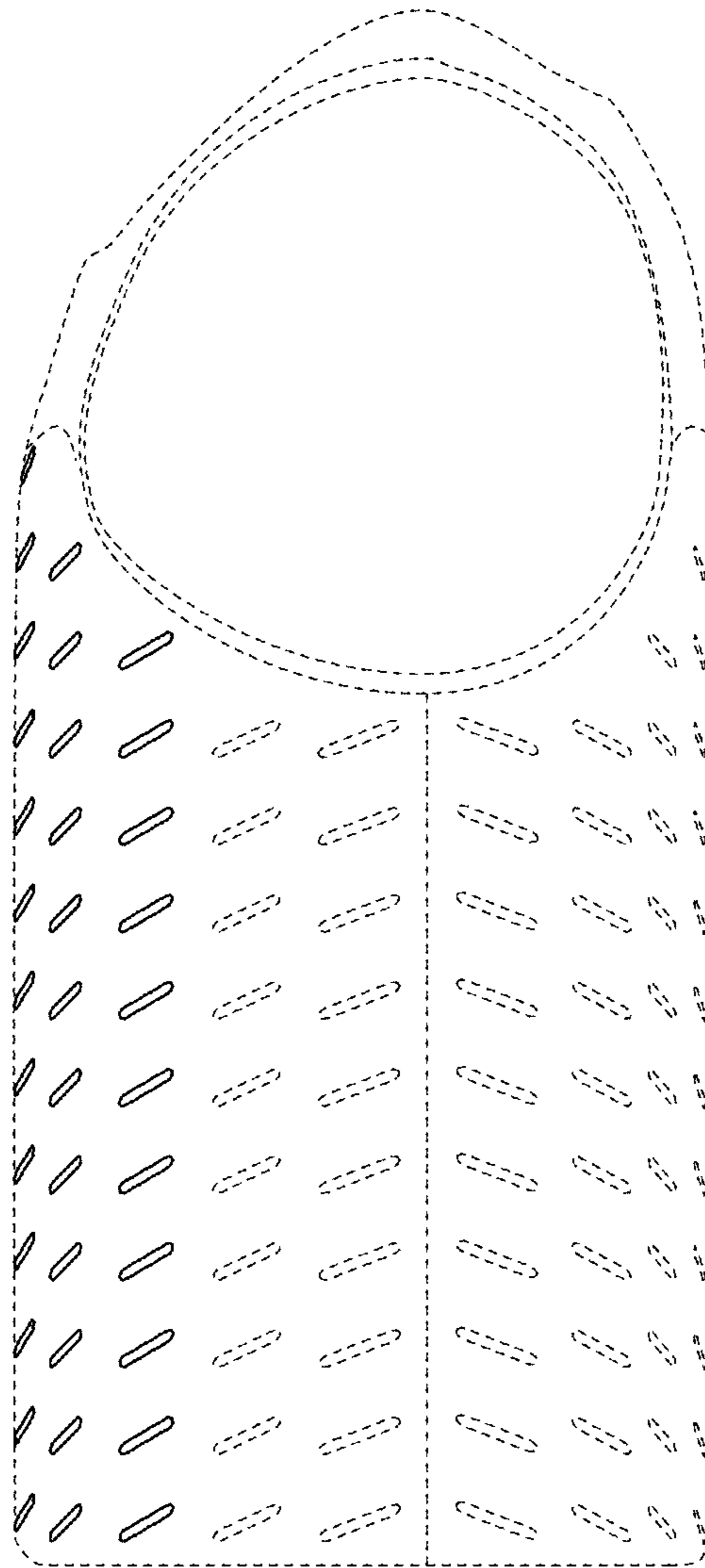
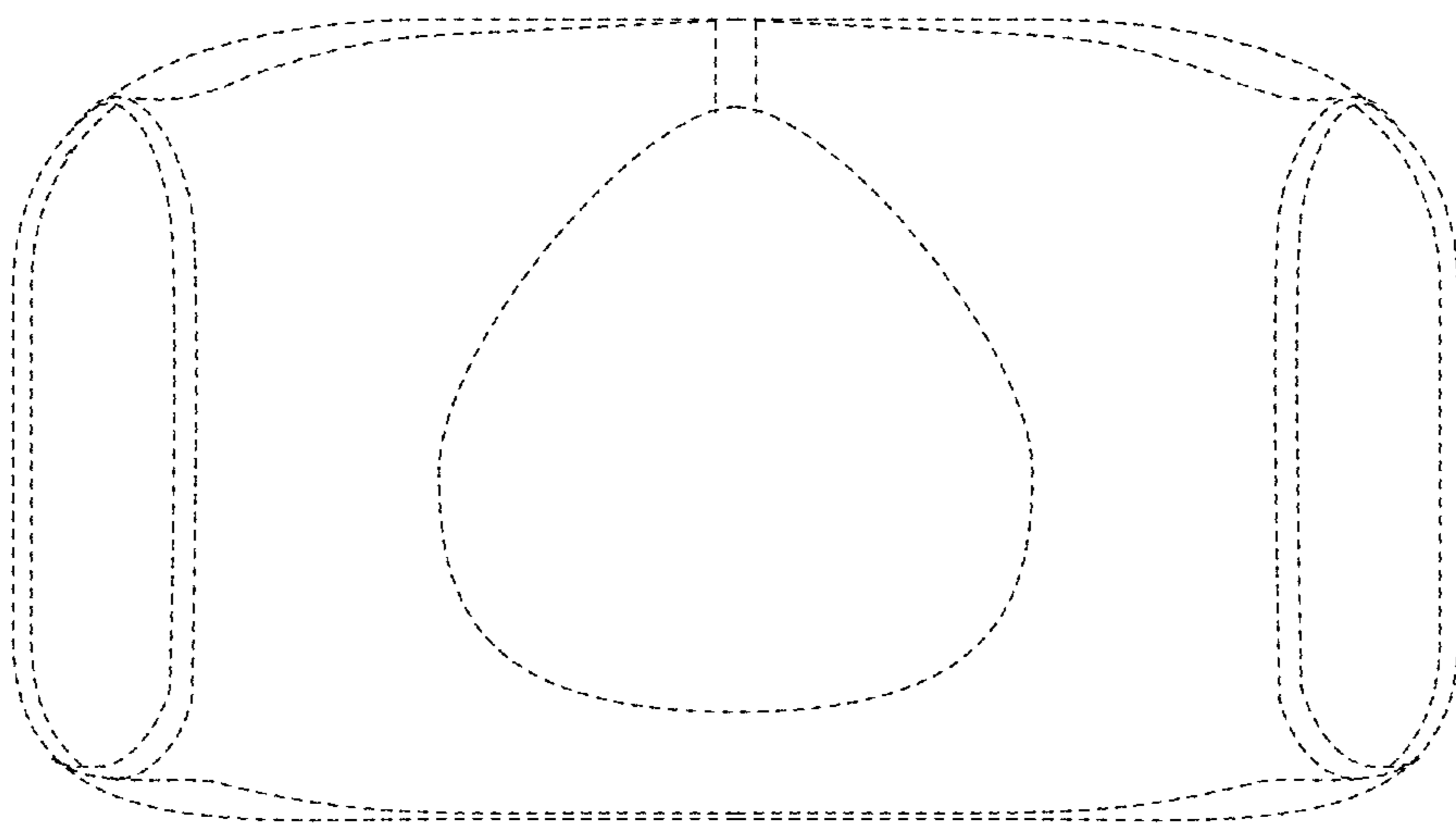
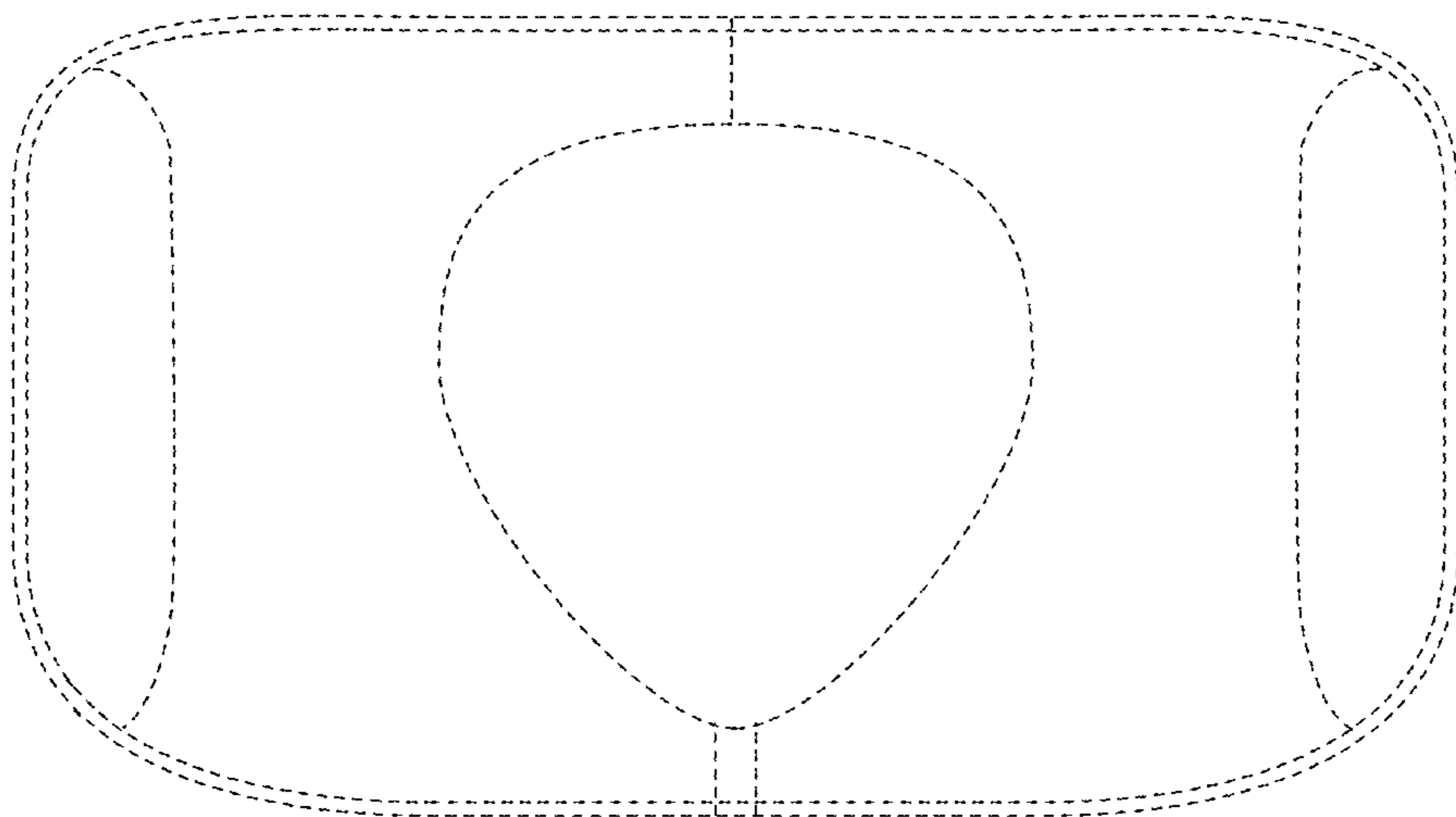

FIG. 5



**FIG. 6**



**FIG. 7**



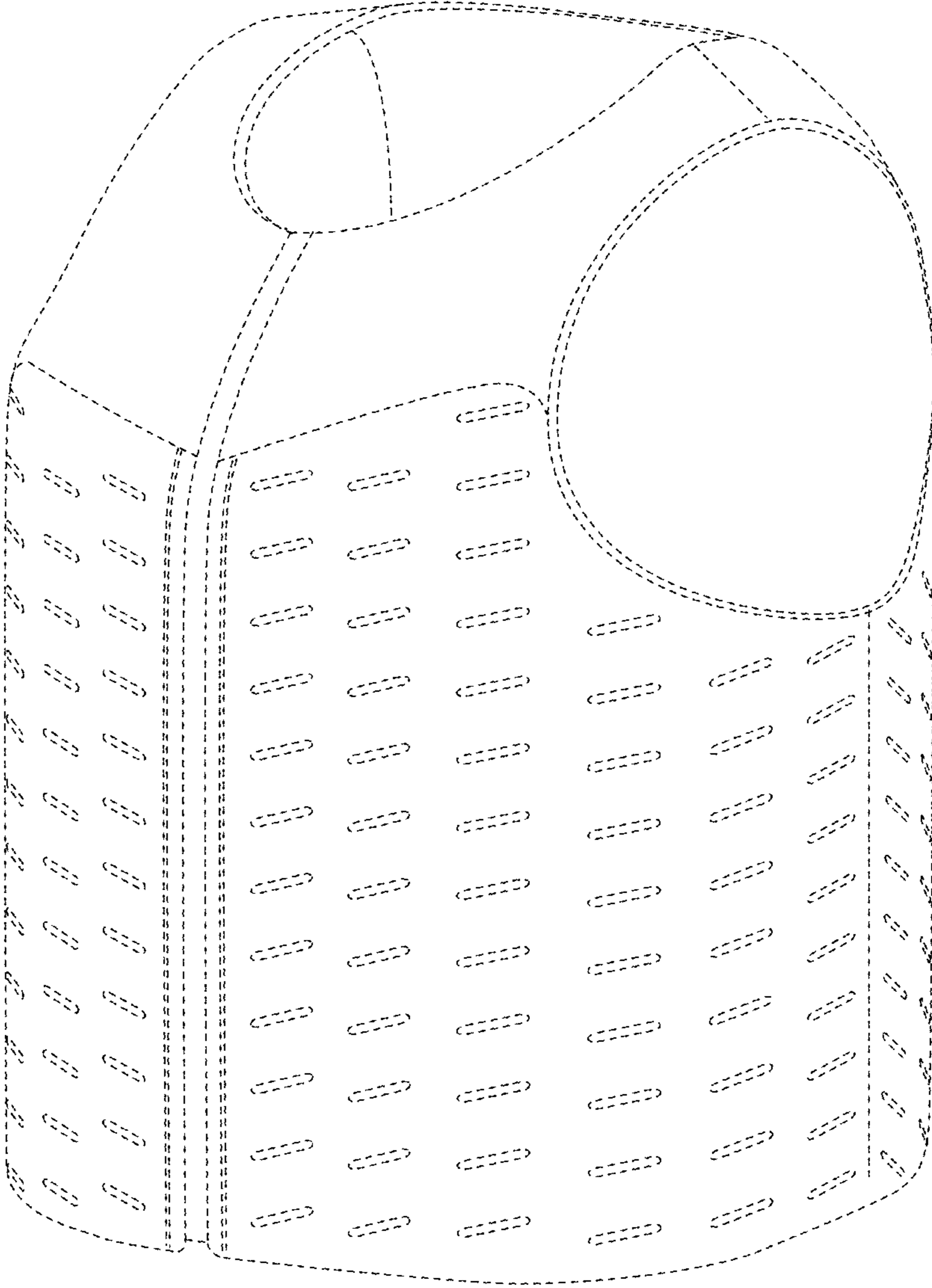
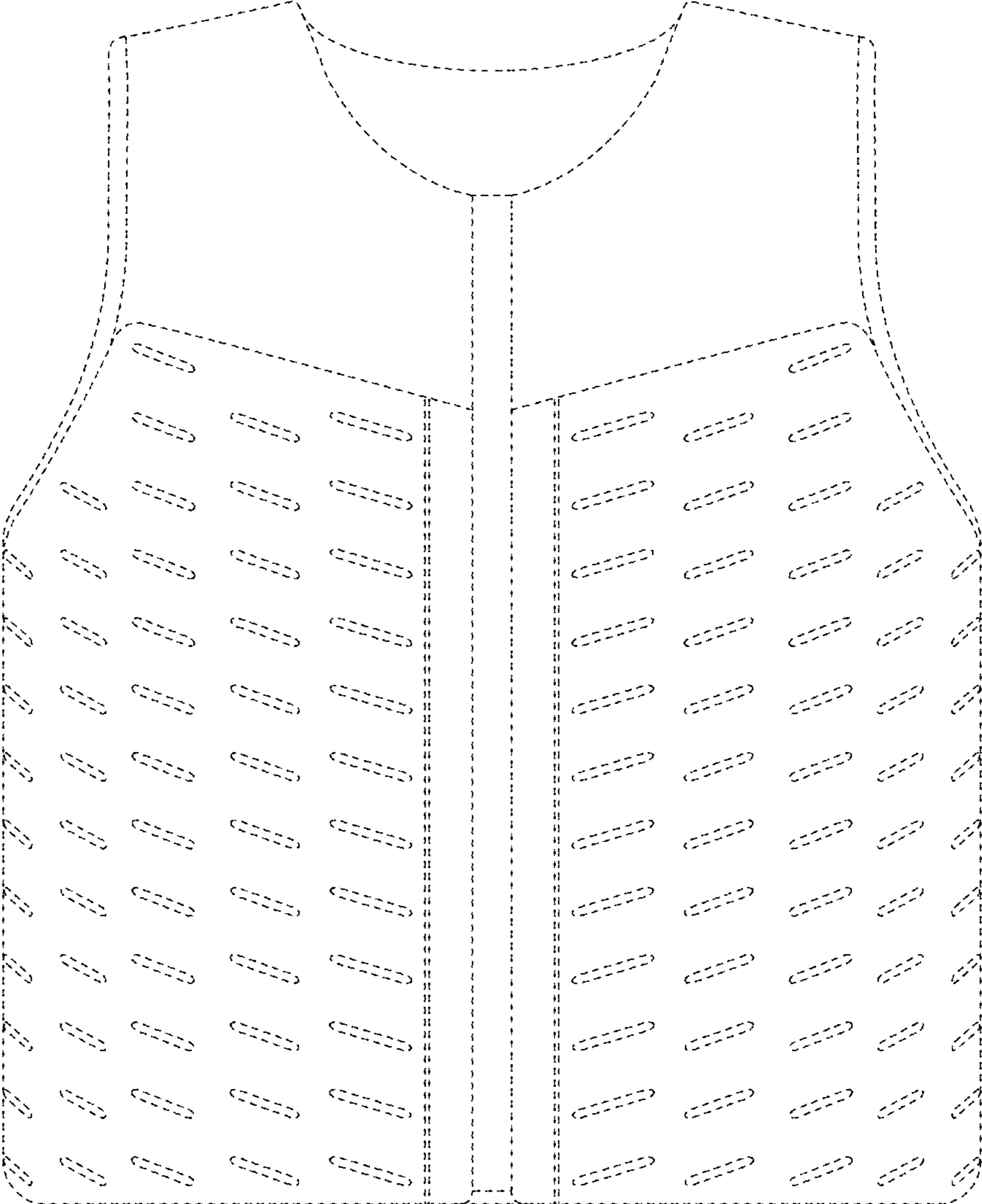

FIG. 8



**FIG. 9**

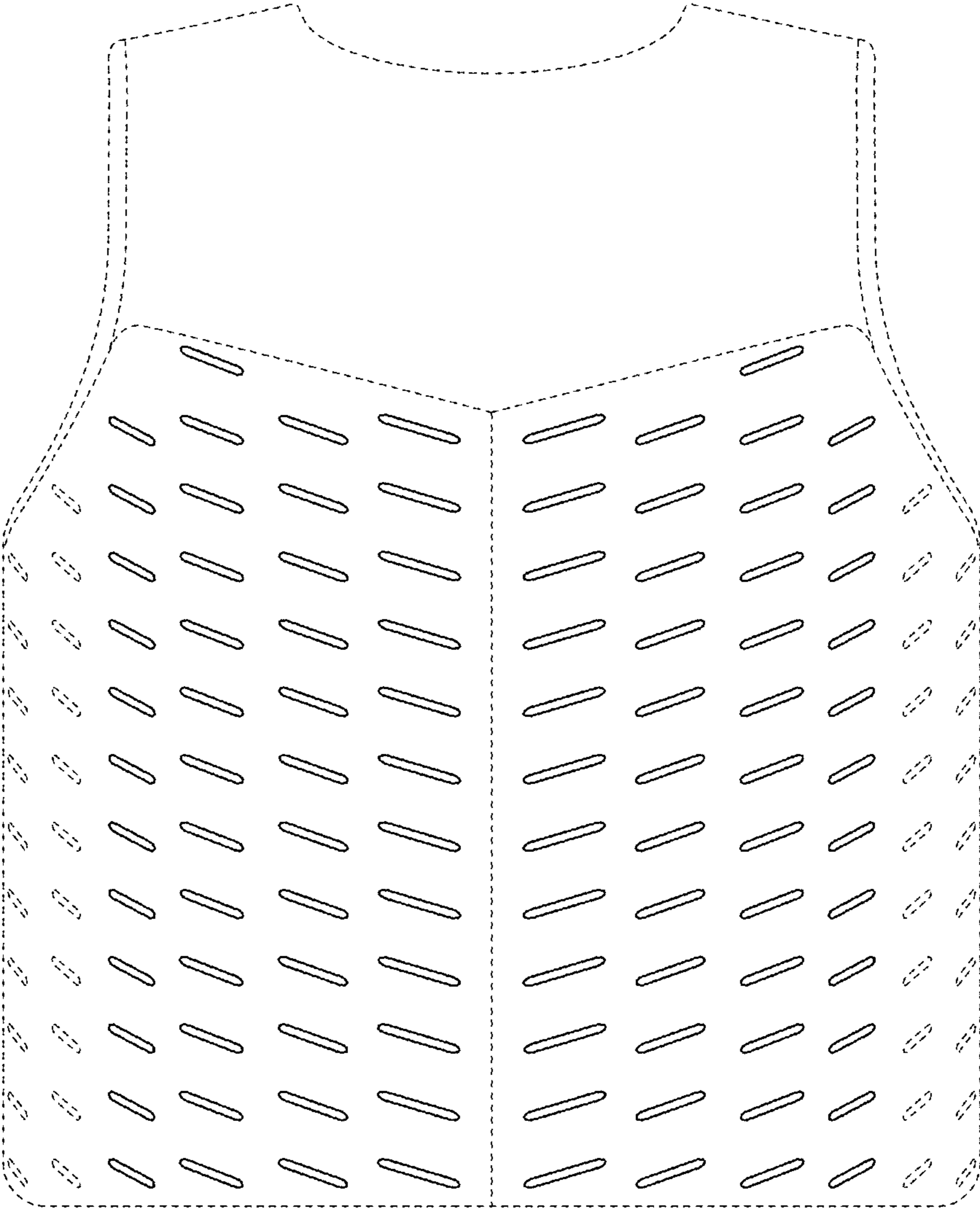

FIG. 10

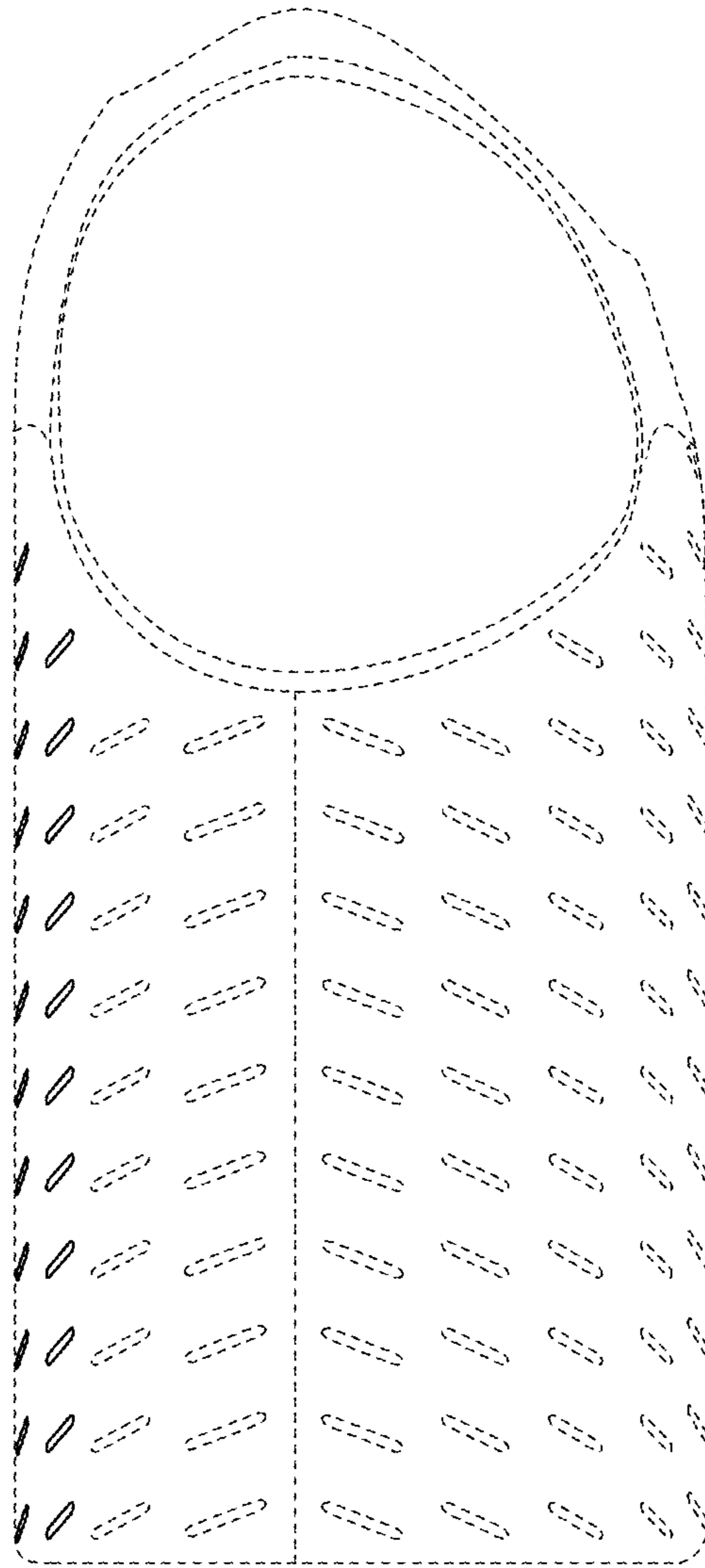

FIG. 11

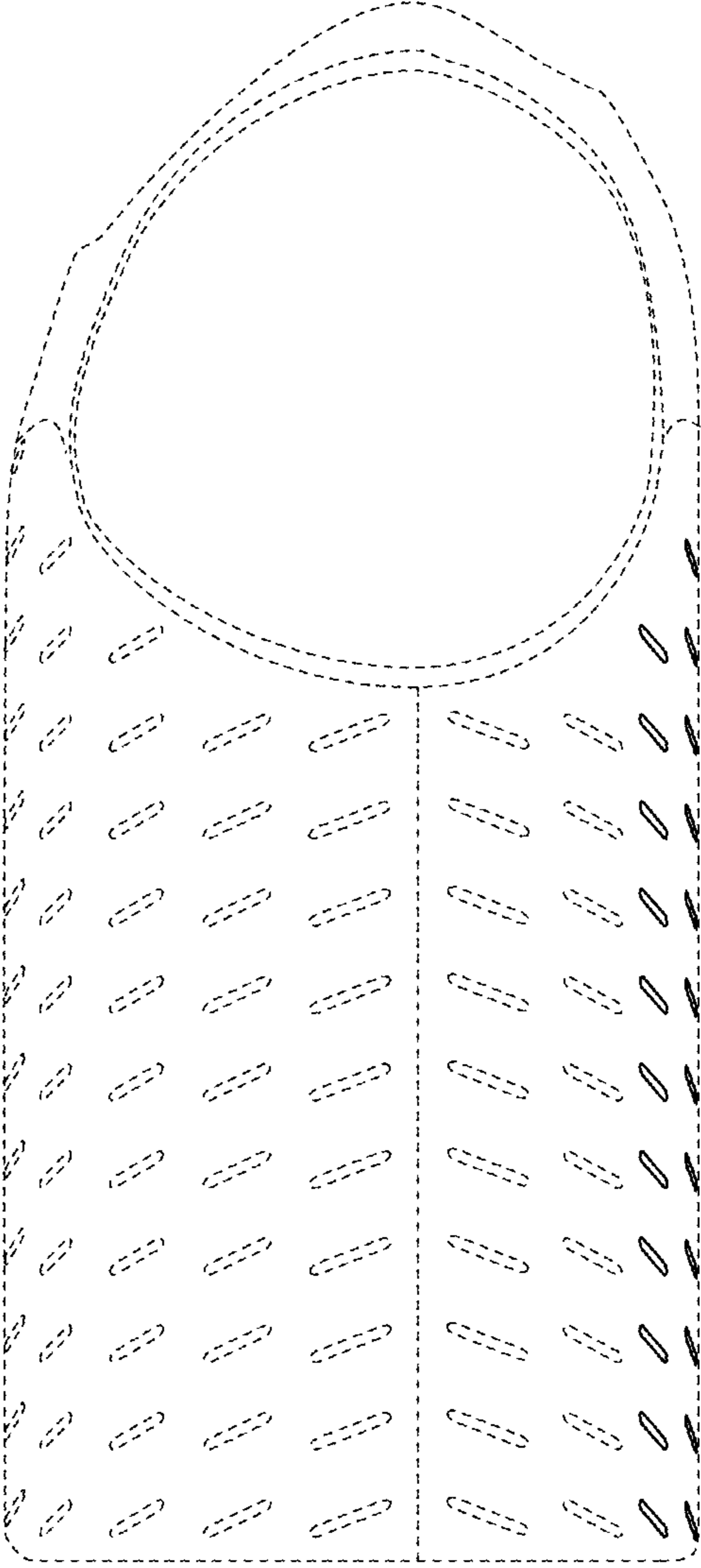
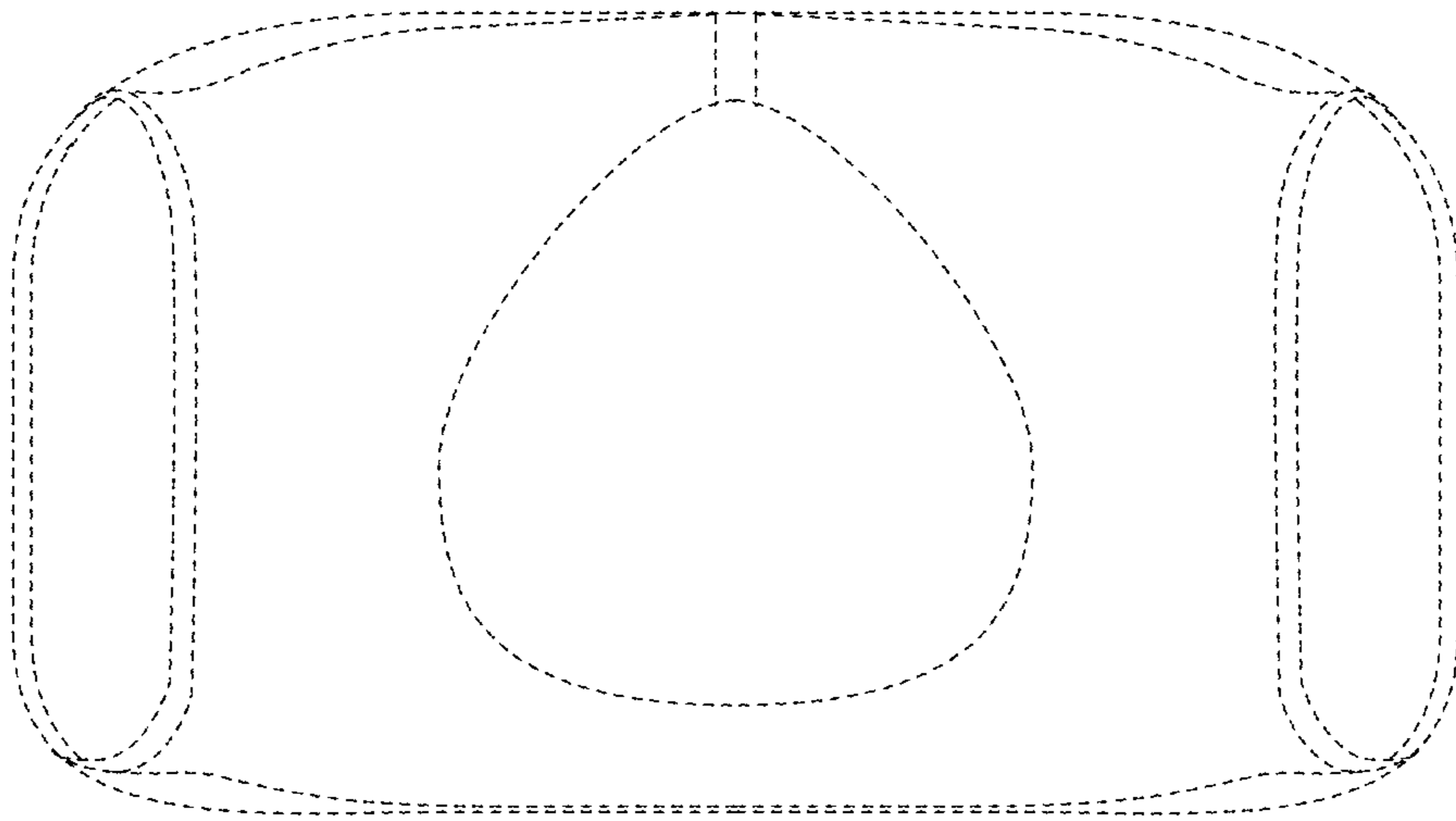
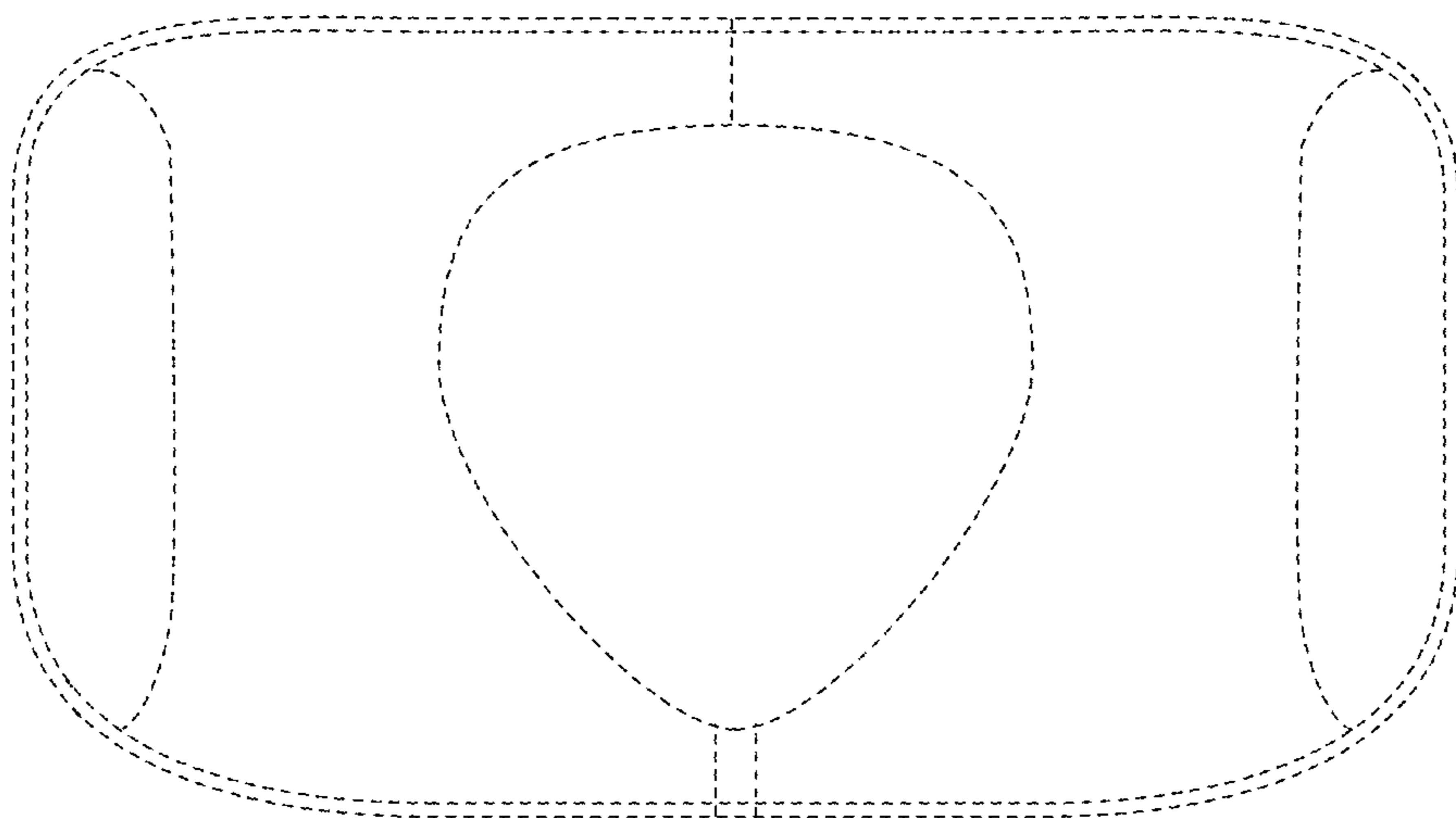

FIG. 12





**FIG. 13**



**FIG. 14**