



US00D880634S

(12) **United States Design Patent**  
**Peterson**

(10) **Patent No.:** **US D880,634 S**

(45) **Date of Patent:** **\*\* Apr. 7, 2020**

(54) **INFLATABLE TOWABLE VEHICLE**

(71) Applicant: **SDS Asia Limited, BVI #1748971,**  
Hong Kong (CN)

(72) Inventor: **Leroy L. Peterson, Omaha, NE (US)**

(73) Assignee: **SDS Asia Limited, BVI #1748971,**  
Central Hong Kong (HK)

(\*\*) Term: **15 Years**

(21) Appl. No.: **29/662,537**

(22) Filed: **Sep. 6, 2018**

(51) **LOC (12) Cl.** ..... **21-02**

(52) **U.S. Cl.**  
USPC ..... **D21/803**

(58) **Field of Classification Search**  
USPC ..... D21/769-770, 801, 803, 809; D12/5, 6,  
D12/316; D6/392, 595, 596, 601, 604,  
D6/605; D29/100, 101.1  
CPC ..... B63B 35/00; B63B 35/001; B63B 35/58;  
B63B 35/73; B63B 35/78  
See application file for complete search history.

(56) **References Cited**

**U.S. PATENT DOCUMENTS**

D427,656 S \* 7/2000 Peterson ..... D21/801  
D428,955 S \* 8/2000 Peterson ..... D21/801

D429,787 S \* 8/2000 Peterson ..... D21/803  
D476,712 S \* 7/2003 Peterson ..... D21/803  
D632,354 S \* 2/2011 Perry ..... D21/803  
D832,963 S \* 11/2018 Su ..... D21/801

\* cited by examiner

*Primary Examiner* — Zenia I Bennett

(74) *Attorney, Agent, or Firm* — Suiter Swantz pc llo

(57) **CLAIM**

The ornamental design for an inflatable towable vehicle, as shown and described.

**DESCRIPTION**

FIG. 1 is a perspective view showing our new design;  
FIG. 2 is a top plan view thereof;  
FIG. 3 is a bottom plan view thereof;  
FIG. 4 is a front elevation view thereof;  
FIG. 5 is a rear elevation view thereof;  
FIG. 6 is a right side elevation view thereof; and,  
FIG. 7 is a left side elevation view thereof;  
The broken lines showing stitching, a bottom portion,  
valves, straps, and handles of FIGS. 1-7 form no part of the  
claimed design.

**1 Claim, 7 Drawing Sheets**

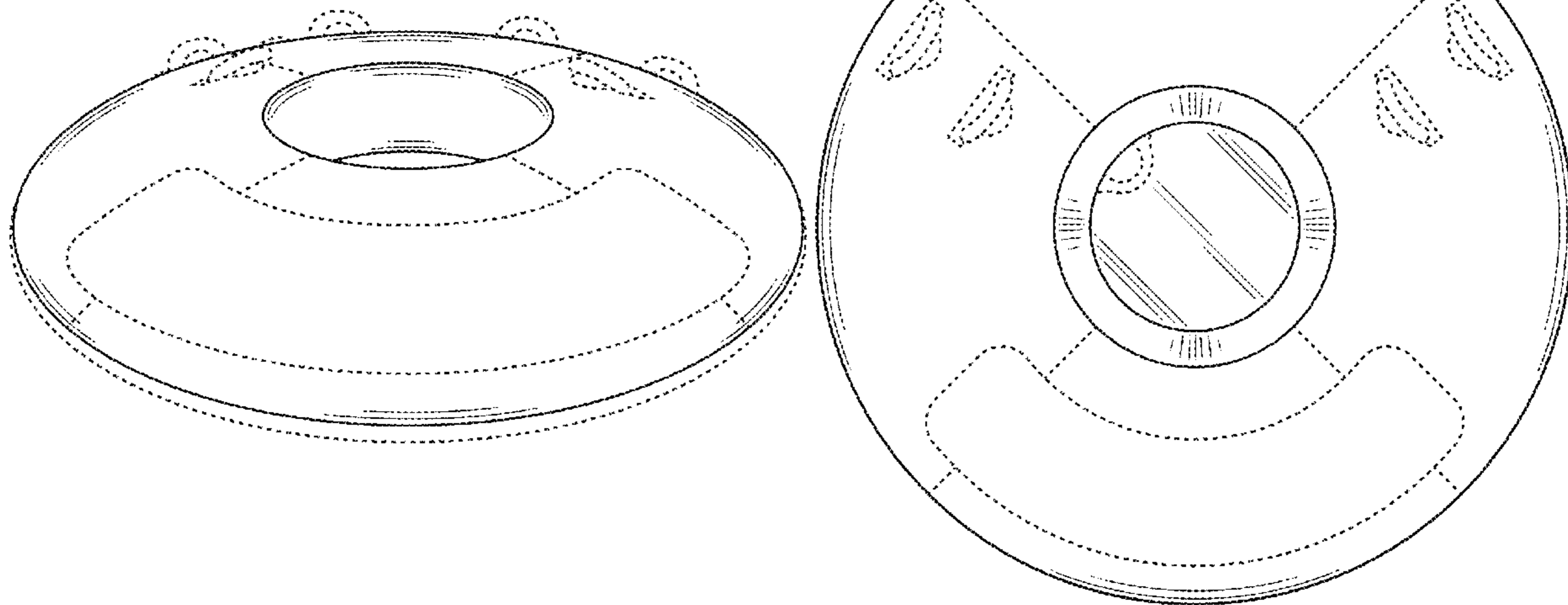

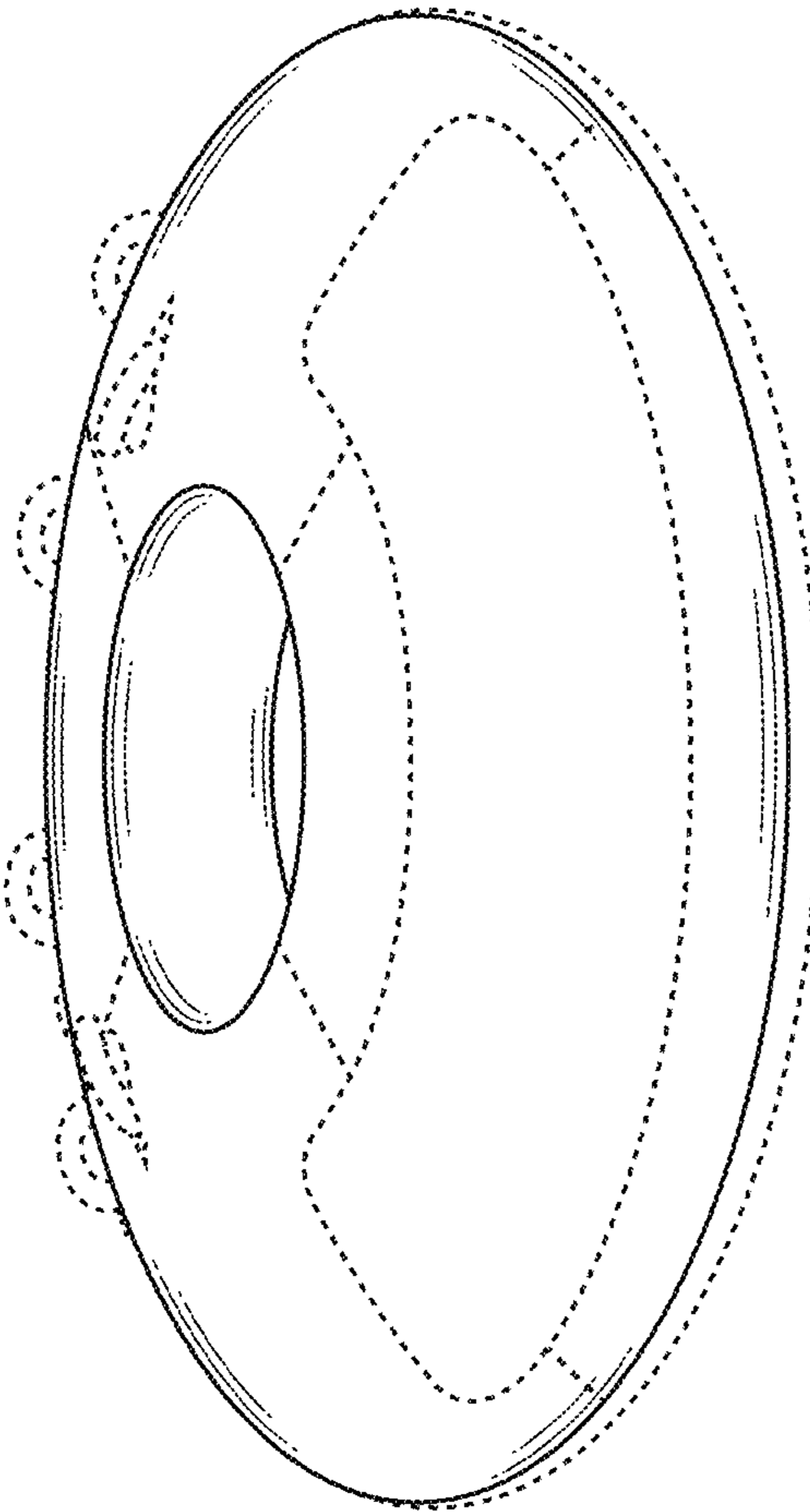

FIG.1

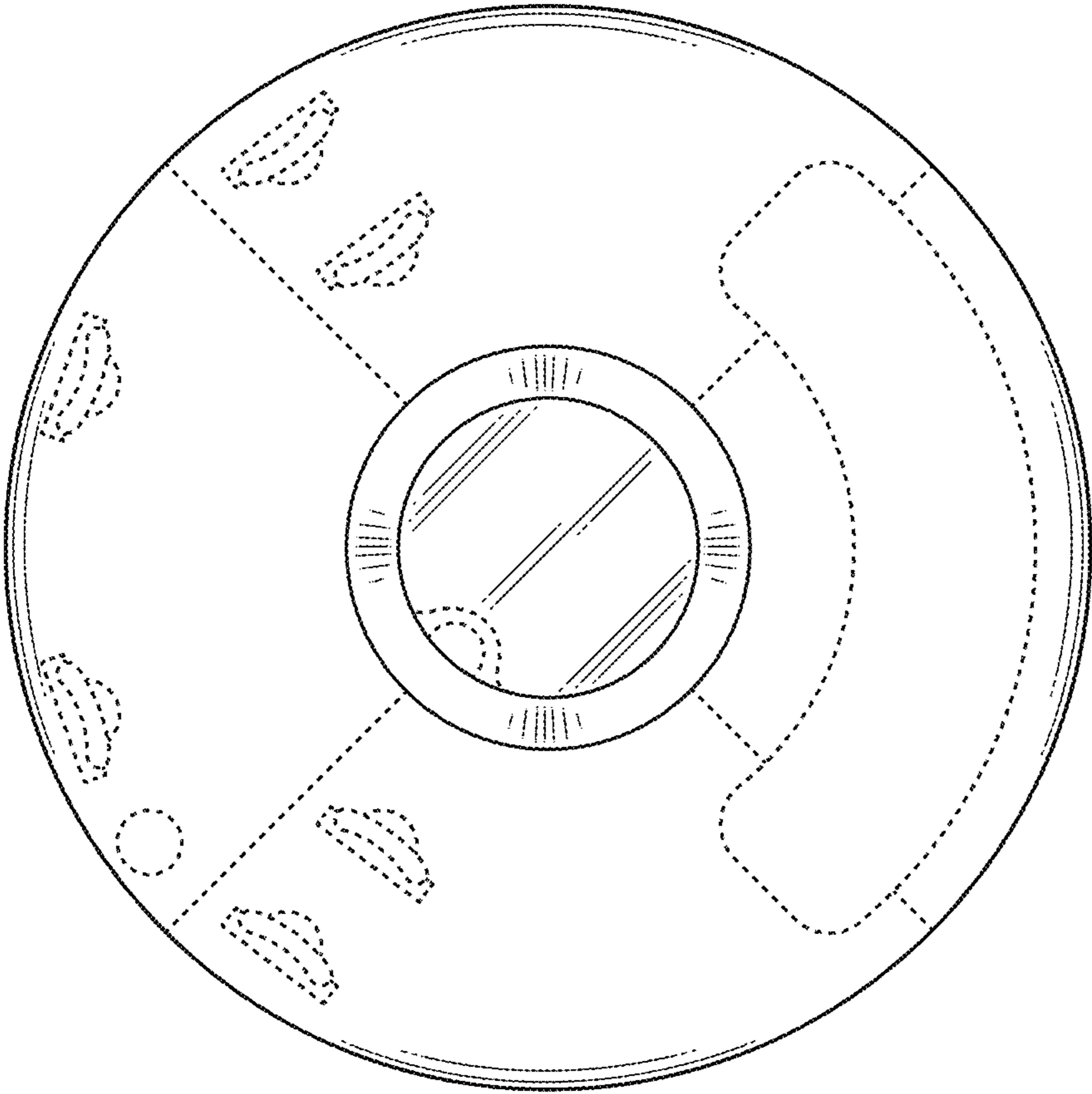

FIG.2

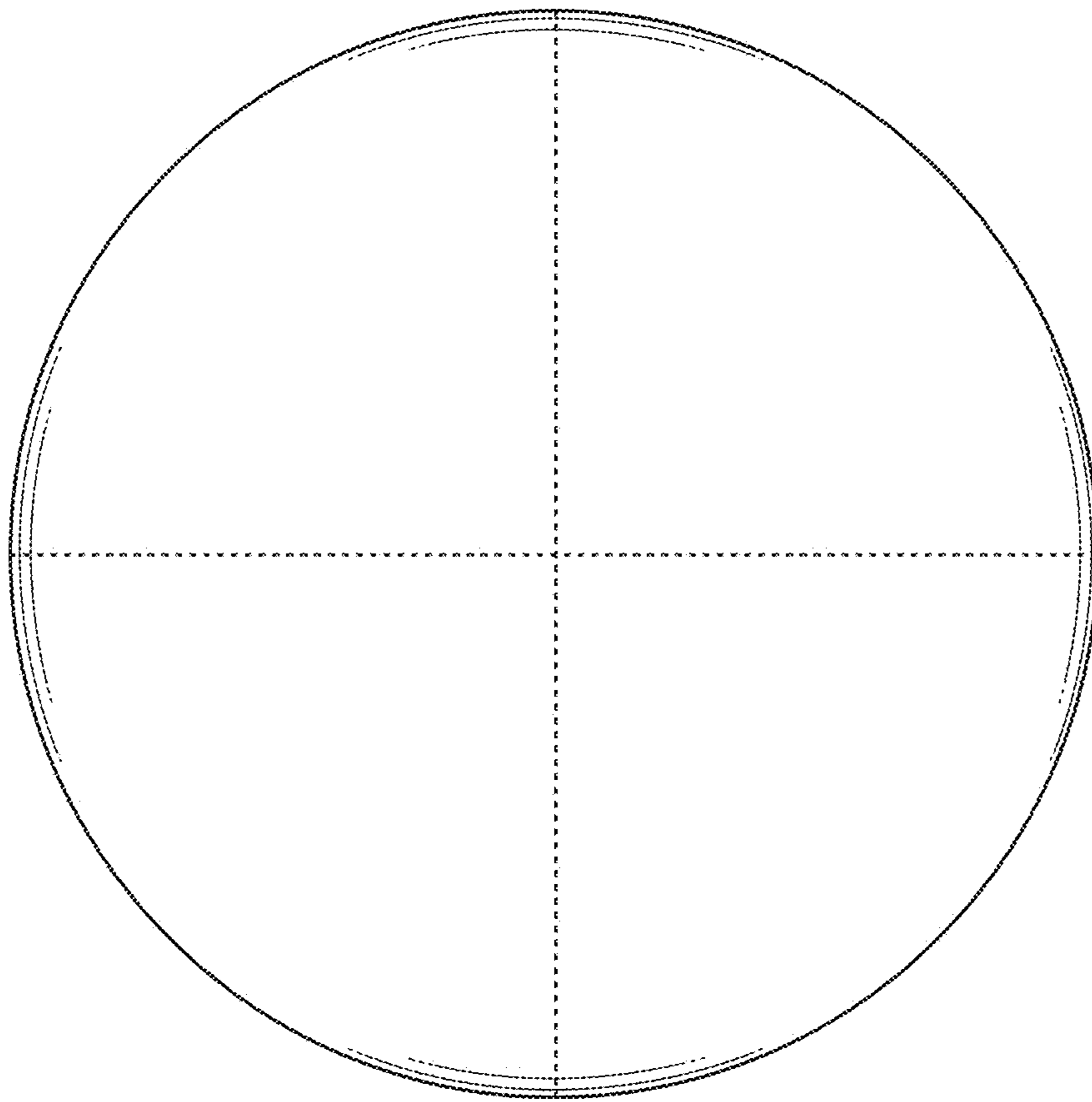

FIG. 3

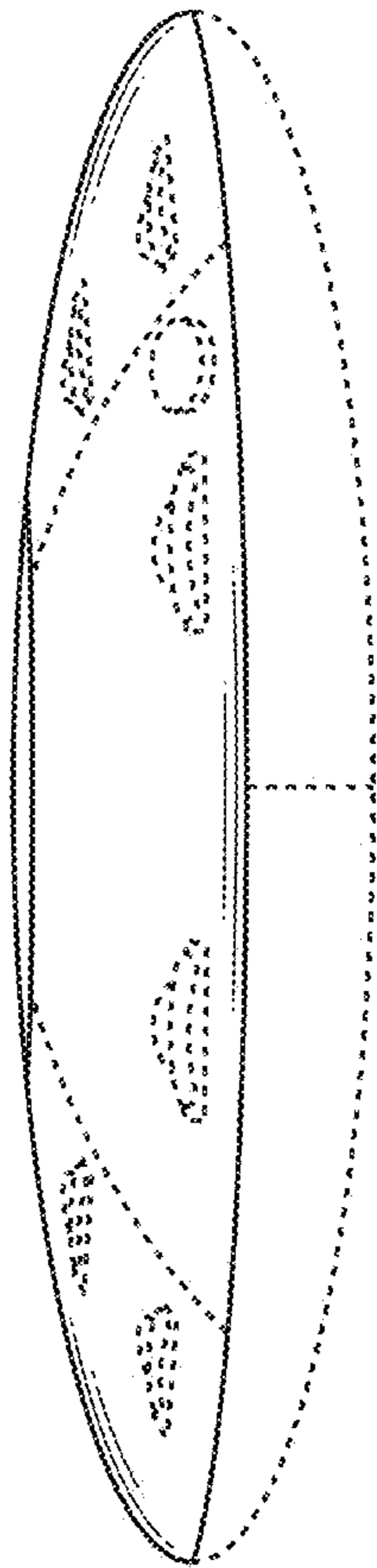

FIG. 4

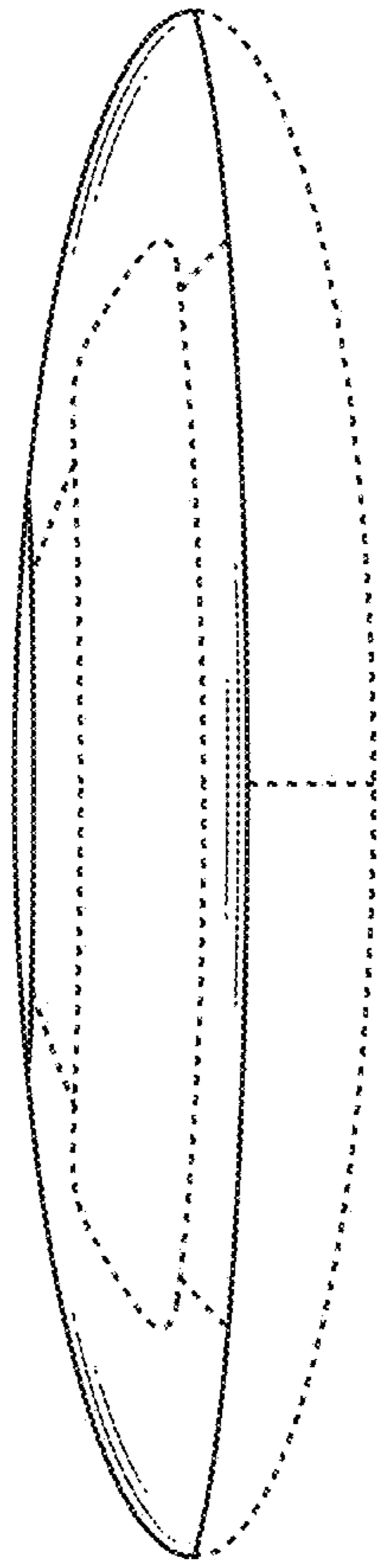

FIG. 5

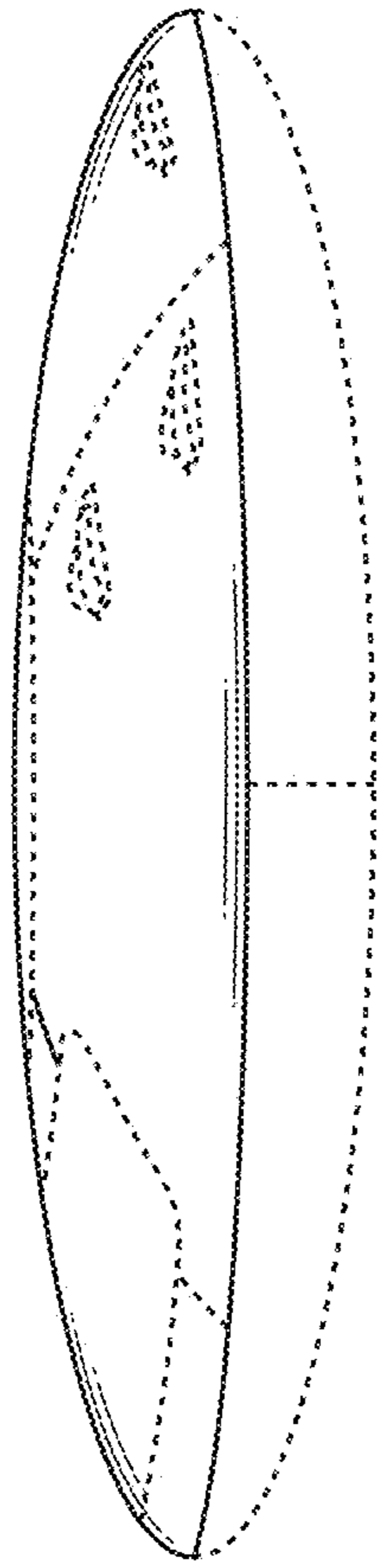

FIG. 6

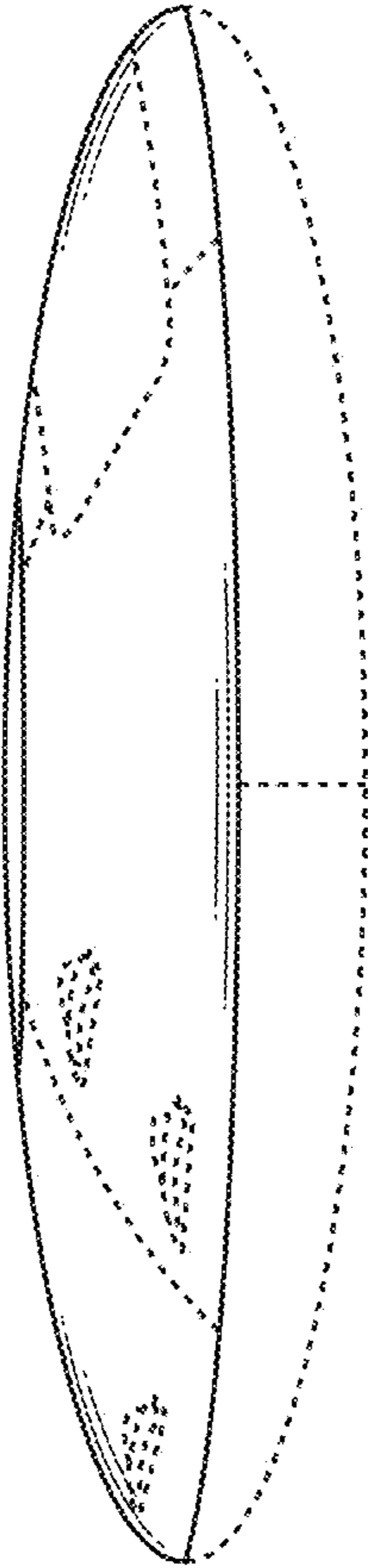

FIG.7