



US00D880631S

(12) **United States Design Patent**
DeMille et al.

(10) **Patent No.:** **US D880,631 S**

(45) **Date of Patent:** **** Apr. 7, 2020**

(54) **PUTTER HEAD**

(71) Applicant: **Callaway Golf Company**, Carlsbad, CA (US)

(72) Inventors: **Brandon D. DeMille**, Carlsbad, CA (US); **William C. Watson**, Temecula, CA (US); **Patrick Dawson**, San Diego, CA (US); **Bradley C. Rice**, Carlsbad, CA (US)

(73) Assignee: **Callaway Golf Company**, Carlsbad, CA (US)

(**) Term: **15 Years**

(21) Appl. No.: **29/673,358**

(22) Filed: **Dec. 13, 2018**

(51) **LOC (12) Cl.** **21-02**

(52) **U.S. Cl.**
USPC **D21/736**

(58) **Field of Classification Search**
USPC D21/736–746, 759
CPC A63B 53/00; A63B 53/04; A63B 53/007;
A63B 53/065; A63B 53/0487; A63B
60/00; A63B 60/46

See application file for complete search history.

(56) **References Cited**

U.S. PATENT DOCUMENTS

D470,904 S * 2/2003 Tang D21/742
D479,291 S * 9/2003 Murray D21/742

D572,780 S * 7/2008 Rollinson D21/744
D592,717 S * 5/2009 Rollinson D21/742
D688,340 S * 8/2013 Tang D21/742
D730,462 S * 5/2015 Becktor D21/742
D777,267 S * 1/2017 Dolezel D21/742
D846,672 S * 4/2019 Rollinson D21/744

* cited by examiner

Primary Examiner — Mitchell I. Siegel
(74) *Attorney, Agent, or Firm* — Rebecca Hanovice;
Michael Catania; Sonia Lari

(57) **CLAIM**

The ornamental design for a putter head, as shown and described.

DESCRIPTION

FIG. 1 is a rear perspective view of the putter head claimed herein;
FIG. 2 is a rear elevational view thereof;
FIG. 3 is a front elevational view thereof;
FIG. 4 is a right side elevational view thereof;
FIG. 5 is a left side elevational view thereof;
FIG. 6 is a top plan view thereof; and,
FIG. 7 is a bottom plan view thereof.
The broken lines shown are included for the purpose of illustrating unclaimed subject matter and forms no part of the claimed design.

1 Claim, 5 Drawing Sheets

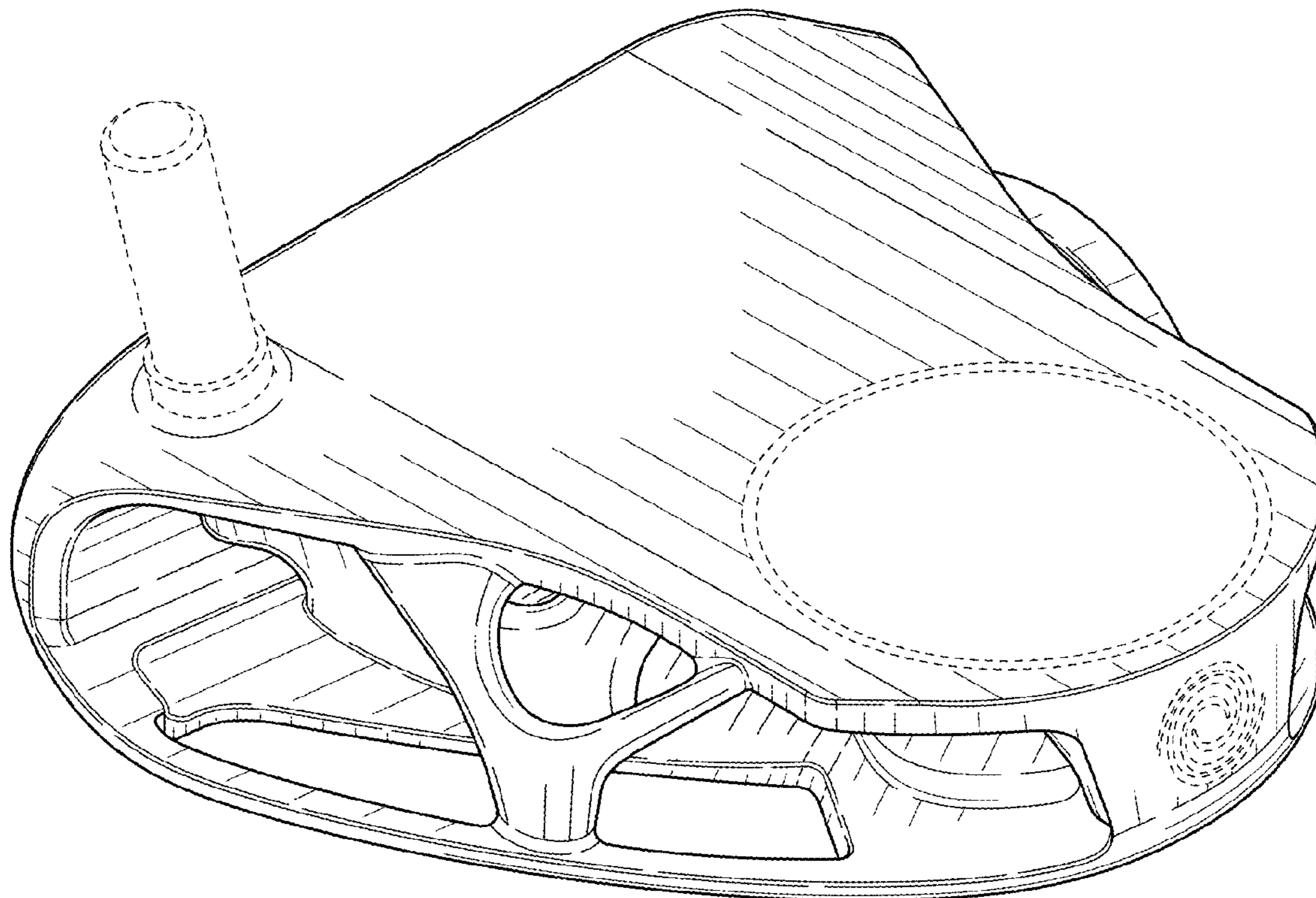

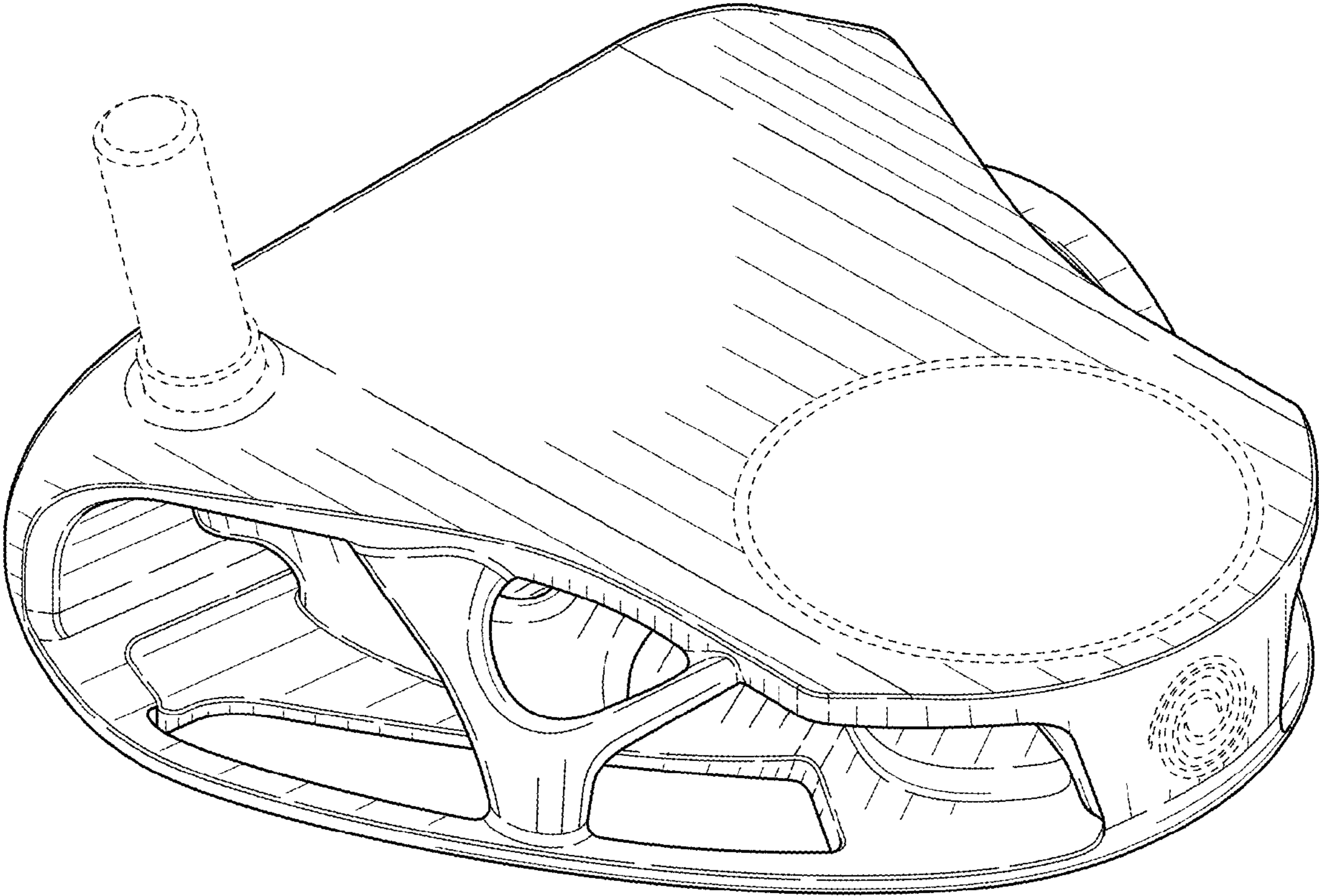

FIG. 1

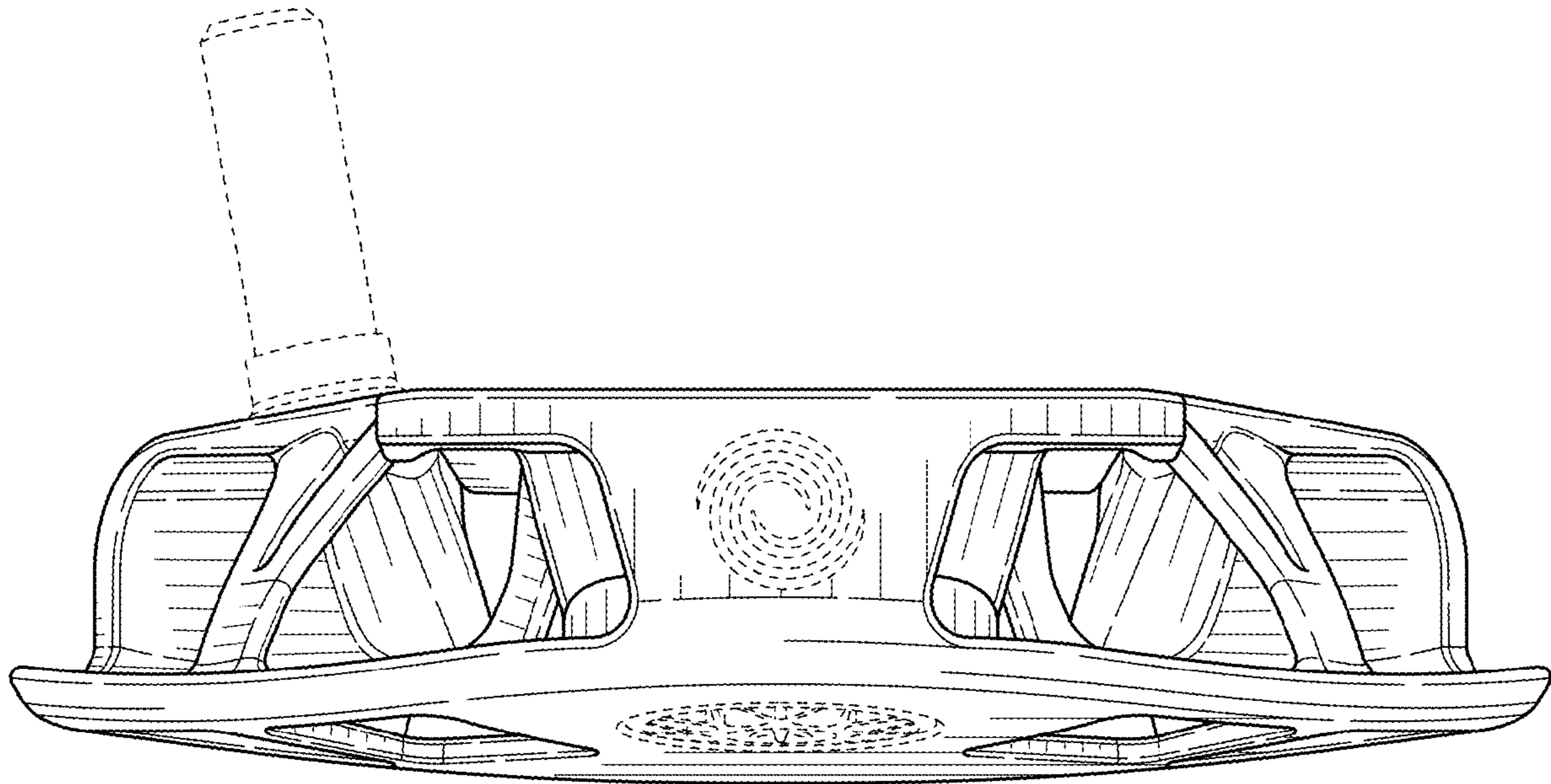

FIG. 2

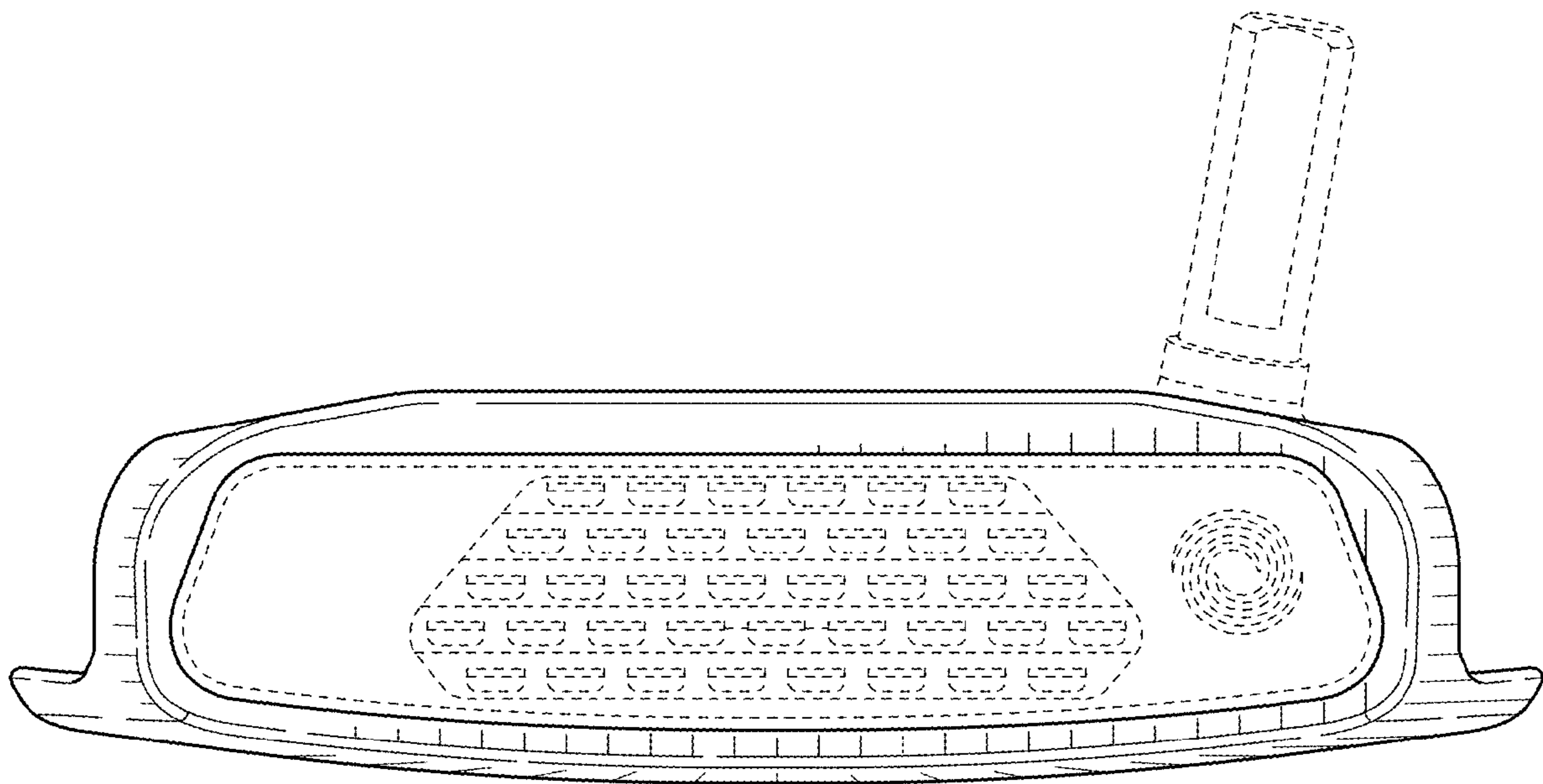

FIG. 3

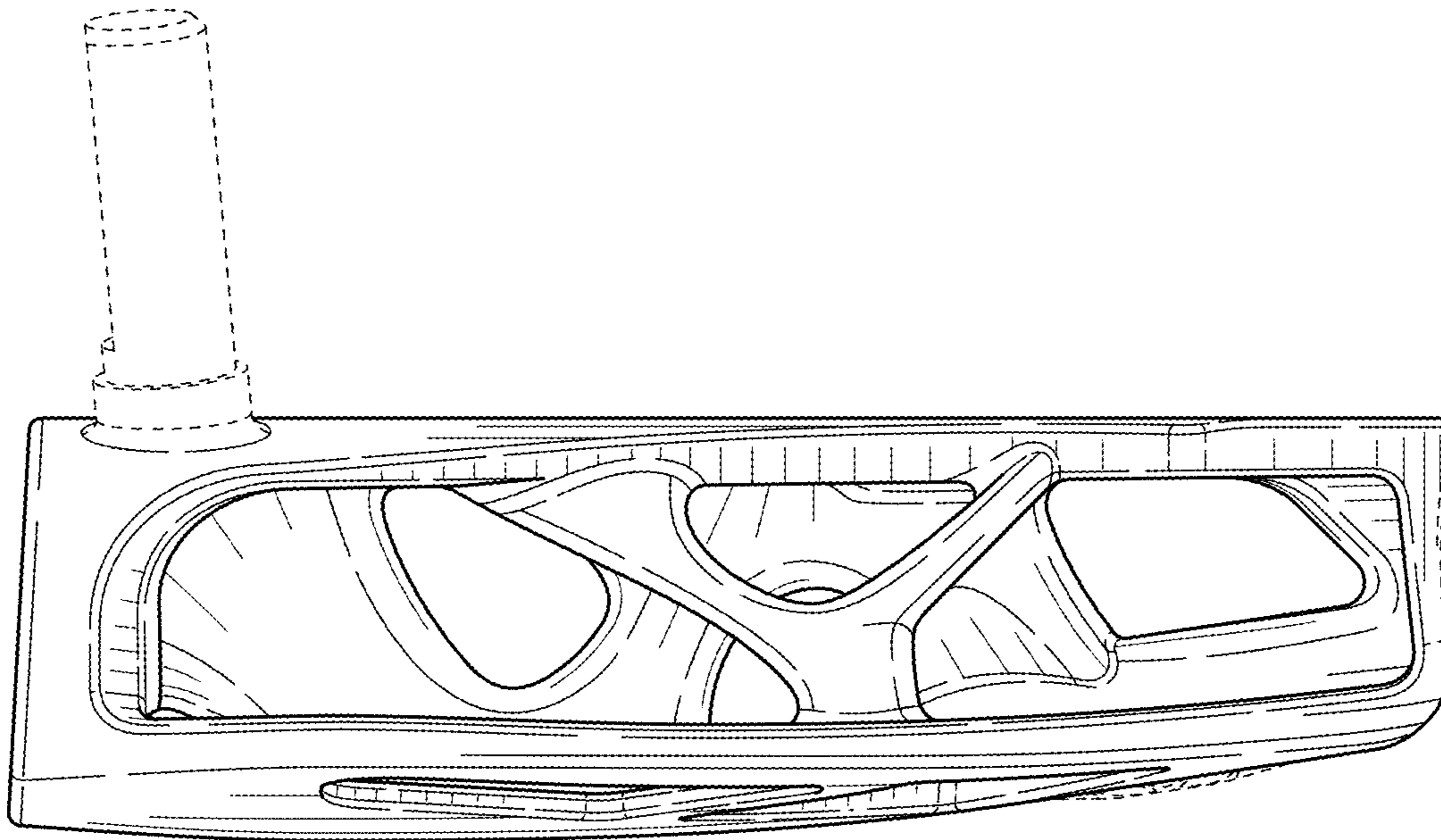

FIG. 4

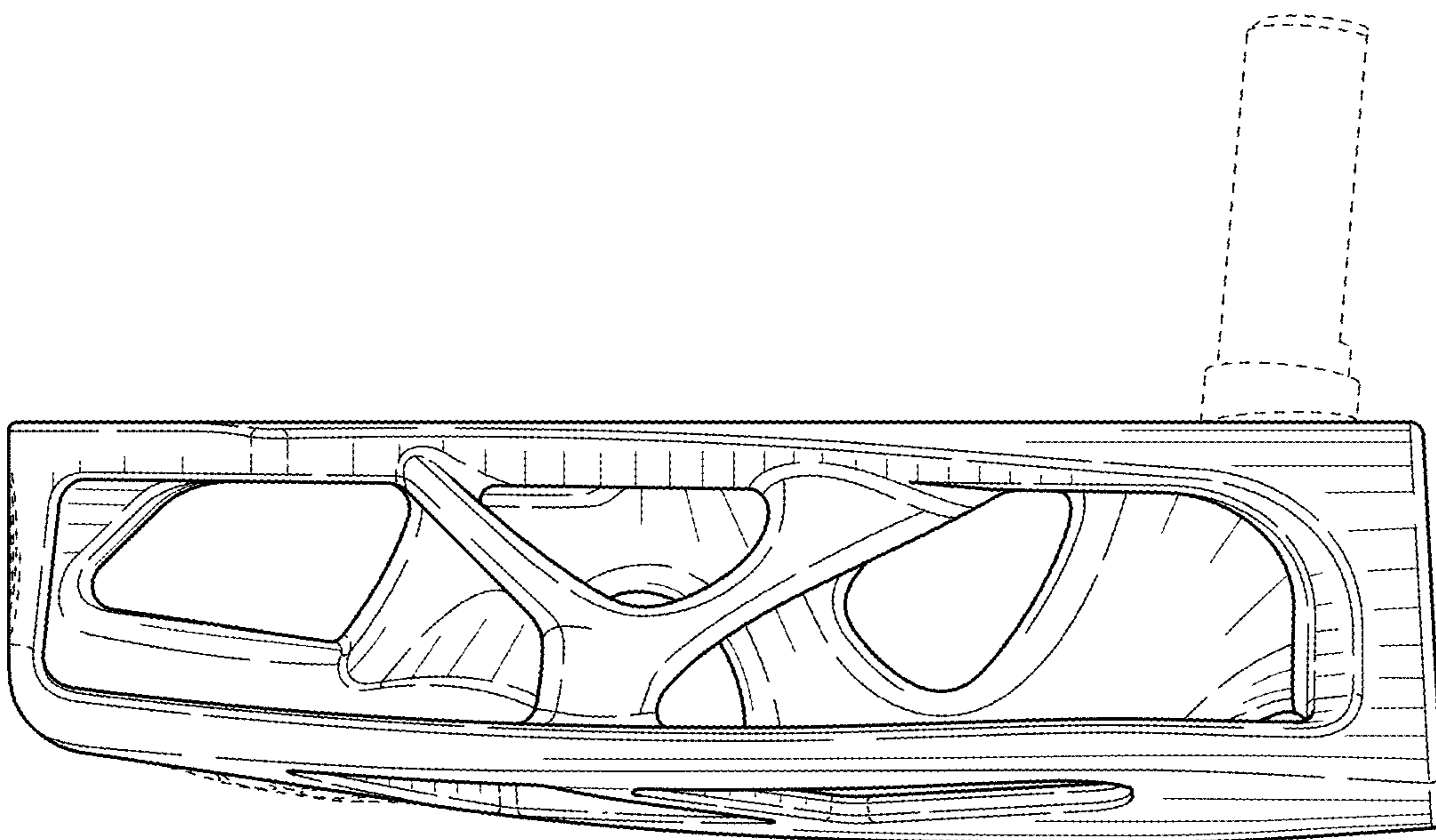

FIG. 5

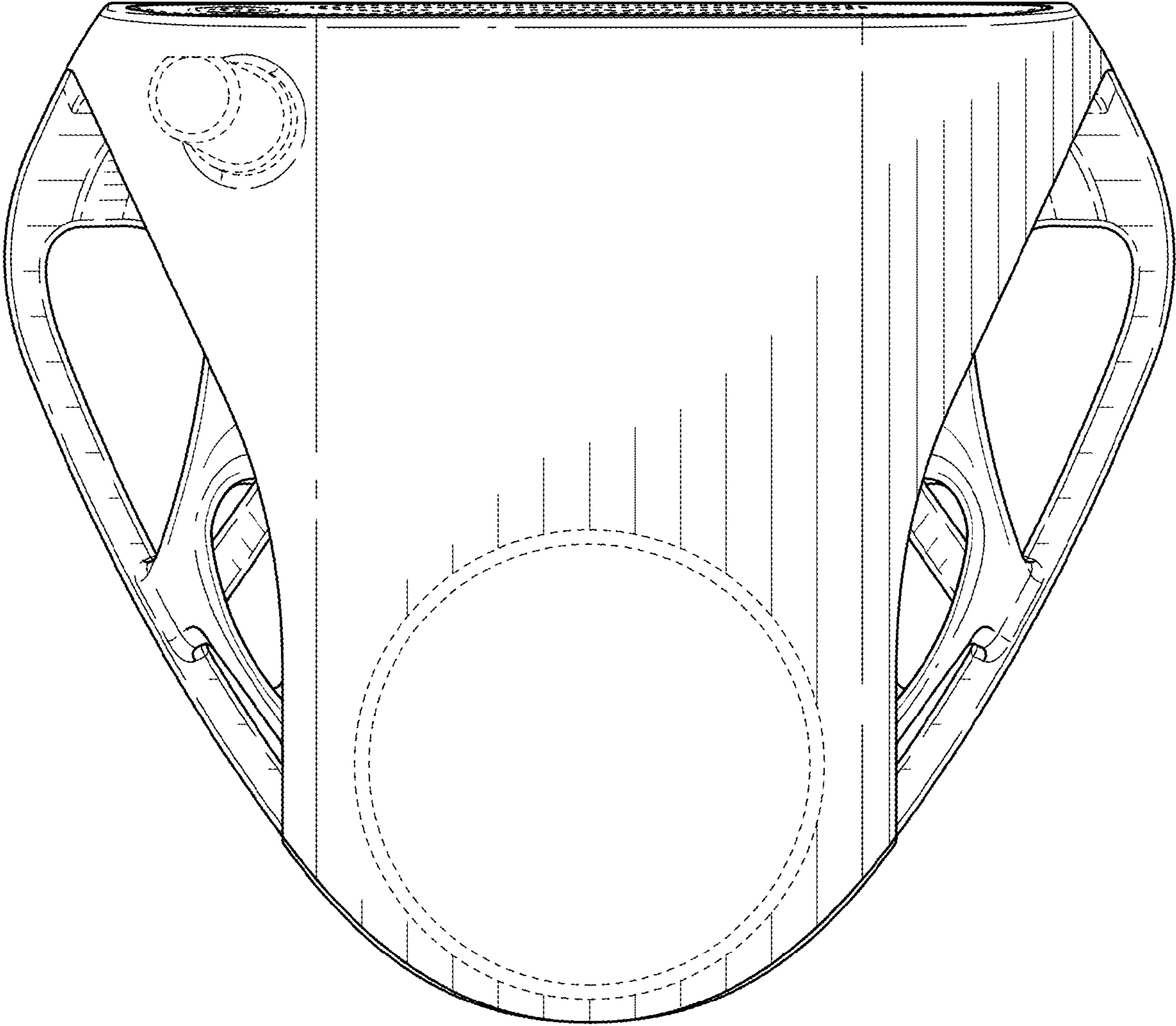

FIG. 6

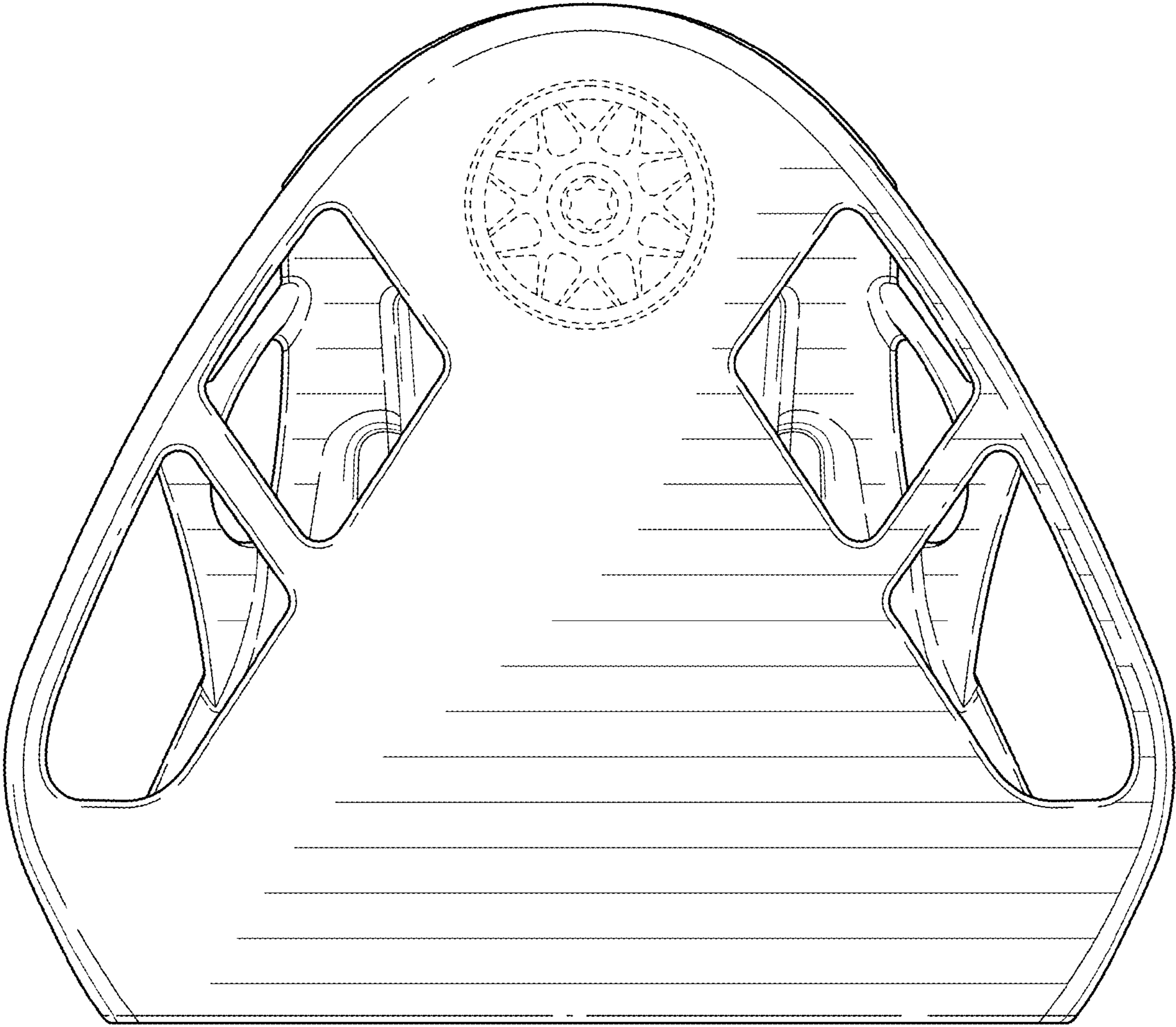

FIG. 7