



US00D880623S

(12) **United States Design Patent**
Narita et al.

(10) **Patent No.:** **US D880,623 S**
(45) **Date of Patent:** **** Apr. 7, 2020**

(54) **ACCESSORY FOR SPINNING TOP TOY**

DESCRIPTION

(71) Applicant: **TOMY COMPANY, LTD.**, Tokyo (JP)

(72) Inventors: **Kouji Narita**, Tokyo (JP); **Masamichi Okutsu**, Tokyo (JP)

(73) Assignee: **TOMY COMPANY, LTD.**, Tokyo (JP)

(**) Term: **15 Years**

(21) Appl. No.: **29/611,957**

(22) Filed: **Jul. 27, 2017**

(30) **Foreign Application Priority Data**

Mar. 1, 2017 (JP) 2017-004141

(51) **LOC (12) Cl.** **21-01**

(52) **U.S. Cl.**
USPC **D21/460**

(58) **Field of Classification Search**
USPC D21/455-464; 446/236-266
(Continued)

(56) **References Cited**

U.S. PATENT DOCUMENTS

D629,469 S * 12/2010 Nishimoto D21/460
D660,918 S * 5/2012 Ujita D21/460
(Continued)

FOREIGN PATENT DOCUMENTS

CN 301715351 * 11/2011
CN 301872977 * 3/2012
(Continued)

Primary Examiner — Catherine A Tuttle

(74) *Attorney, Agent, or Firm* — Staas & Halsey LLP

(57) **CLAIM**

The ornamental design for an accessory for spinning top toy, as shown.

FIG. 1 is a front view of the accessory for spinning top toy showing our design;
FIG. 2 is a left side view thereof;
FIG. 3 is a rear view thereof;
FIG. 4 is right side view thereof;
FIG. 5 is a top view thereof;
FIG. 6 is a bottom view thereof;
FIG. 7 is a perspective view thereof;
FIG. 8 is a front view similar to FIG. 1 but showing the peripheral transparent portion rotated 90° counterclockwise relative to the central transparent portion and opaque portion;
FIG. 9 is a left side view of FIG. 8;
FIG. 10 is a rear view of FIG. 8;
FIG. 11 is a right side view of FIG. 8;
FIG. 12 is a top view of FIG. 8;
FIG. 13 is a bottom view of FIG. 8;
FIG. 14 is a top view of the peripheral transparent portion, shown separately for clarity of disclosure; and
FIG. 15 is a top view of the central transparent portion, shown separately for clarity of disclosure.
FIG. 16 is a front view corresponding to FIG. 1 wherein oblique line hatching has been omitted for clarity of disclosure;
FIG. 17 is a left side view corresponding to FIG. 2 wherein oblique line hatching has been omitted for clarity of disclosure;
FIG. 18 is a rear view corresponding to FIG. 3 wherein oblique line hatching has been omitted for clarity of disclosure;
FIG. 19 is right side view corresponding to FIG. 4 wherein oblique line hatching has been omitted for clarity of disclosure;
FIG. 20 is a top view corresponding to FIG. 5 wherein oblique line hatching has been omitted for clarity of disclosure;
FIG. 21 is a bottom view corresponding to FIG. 6 wherein oblique line hatching has been omitted for clarity of disclosure;

(Continued)

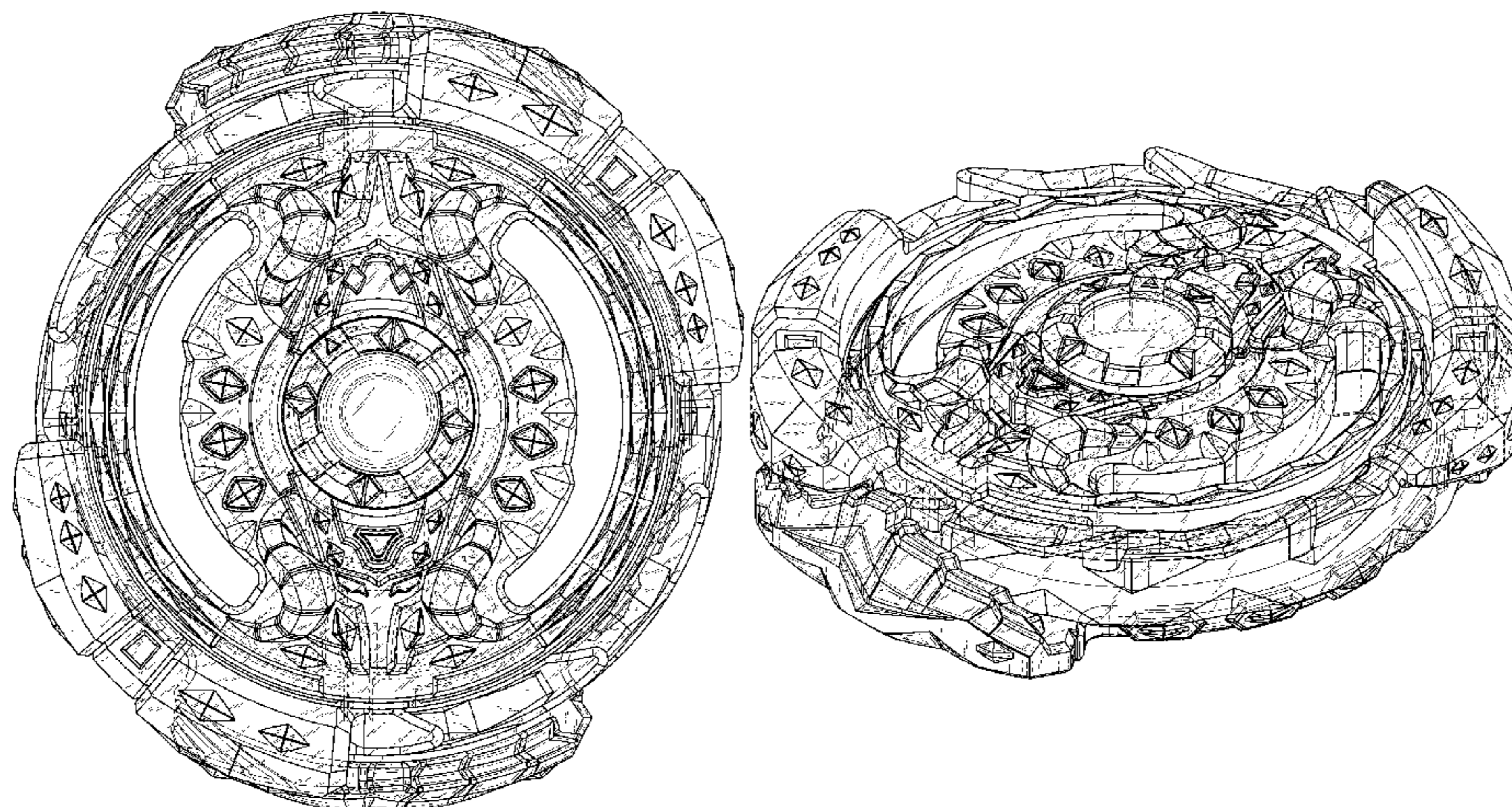

FIG. 22 is a perspective view corresponding to FIG. 7 wherein oblique line hatching has been omitted for clarity of disclosure;

FIG. 23 is a front view corresponding to FIG. 8 wherein oblique line hatching has been omitted for clarity of disclosure;

FIG. 24 is a left side view corresponding to FIG. 9 wherein oblique line hatching has been omitted for clarity of disclosure;

FIG. 25 is a rear view corresponding to FIG. 10 wherein oblique line hatching has been omitted for clarity of disclosure;

FIG. 26 is a right side view corresponding to FIG. 11 wherein oblique line hatching has been omitted for clarity of disclosure;

FIG. 27 is a top view corresponding to FIG. 12 wherein oblique line hatching has been omitted for clarity of disclosure;

FIG. 28 is a bottom view corresponding to FIG. 13 wherein oblique line hatching has been omitted for clarity of disclosure;

FIG. 29 is a top view of the peripheral transparent portion, shown separately and without oblique line hatching for clarity of disclosure; and

FIG. 30 is a top view of the central transparent portion, shown separately and without oblique line hatching for clarity of disclosure.

FIG. 31 is a front view corresponding to FIG. 1 but showing contour shading to the exterior parts, and with the interiors parts omitted for clarity of disclosure;

FIG. 32 is a left side view corresponding to FIG. 2 but showing contour shading to the exterior parts, and with the interiors parts omitted for clarity of disclosure;

FIG. 33 is a rear view corresponding to FIG. 3 but showing contour shading to the exterior parts, and with the interiors parts omitted for clarity of disclosure;

FIG. 34 is right side view corresponding to FIG. 4 but showing contour shading to the exterior parts, and with the interiors parts omitted for clarity of disclosure;

FIG. 35 is a top view corresponding to FIG. 5 but showing contour shading to the exterior parts, and with the interiors parts omitted for clarity of disclosure;

FIG. 36 is a bottom corresponding to FIG. 6 but showing contour shading to the exterior parts, and with the interiors parts omitted for clarity of disclosure;

FIG. 37 is a perspective view corresponding to FIG. 7 but showing contour shading to the exterior parts, and with the interiors parts omitted for clarity of disclosure;

FIG. 38 is a front view corresponding to FIG. 8 but showing contour shading to the exterior parts, and with the interiors parts omitted for clarity of disclosure;

FIG. 39 is a left side view, corresponding to FIG. 9 but showing contour shading to the exterior parts, and with the interiors parts omitted for clarity of disclosure;

FIG. 40 is a rear view corresponding to FIG. 10 but showing contour shading to the exterior parts, and with the interiors parts omitted for clarity of disclosure;

FIG. 41 is a right side view corresponding to FIG. 11 but showing contour shading to the exterior parts, and with the interiors parts omitted for clarity of disclosure; and,

FIG. 42 is a top view corresponding to FIG. 12 but showing contour shading to the exterior parts, and with the interiors parts omitted for clarity of disclosure.

The portions of the accessory for spinning top toy shown in broken lines form no part of the claimed design.

1 Claim, 42 Drawing Sheets

(58) **Field of Classification Search**

CPC A63H 1/00-32
See application file for complete search history.

(56) **References Cited**

U.S. PATENT DOCUMENTS

D662,556	S *	6/2012	Horikoshi	D21/460
D665,859	S *	8/2012	Horikoshi	D21/460
D666,252	S *	8/2012	Ujita	D21/460
D666,253	S *	8/2012	Ujita	D21/460
D667,894	S *	9/2012	Horikoshi	D21/460
D820,919	S *	6/2018	Horikoshi	D21/460
D827,044	S *	8/2018	Horikoshi	D21/460
D827,045	S *	8/2018	Horikoshi	D21/460
D827,046	S *	8/2018	Horikoshi	D21/460
D841,099	S *	2/2019	Matsukawa	D21/460

FOREIGN PATENT DOCUMENTS

CN	303863705	*	6/2016
CN	303863727	*	9/2016
CN	303970411	*	12/2016
WO	D096791-004	*	1/2018

* cited by examiner

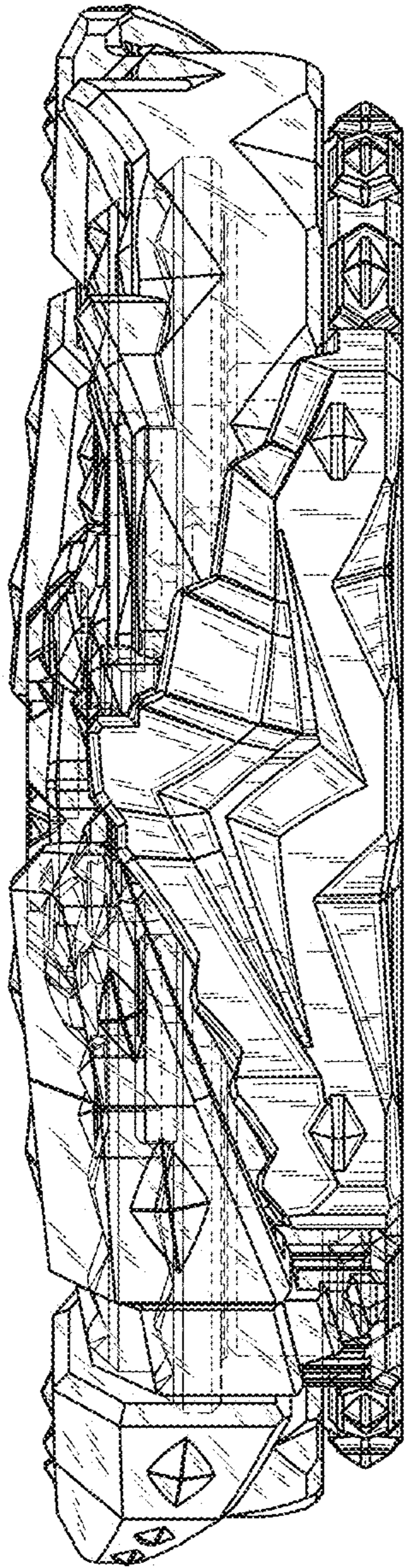

FIG. 1

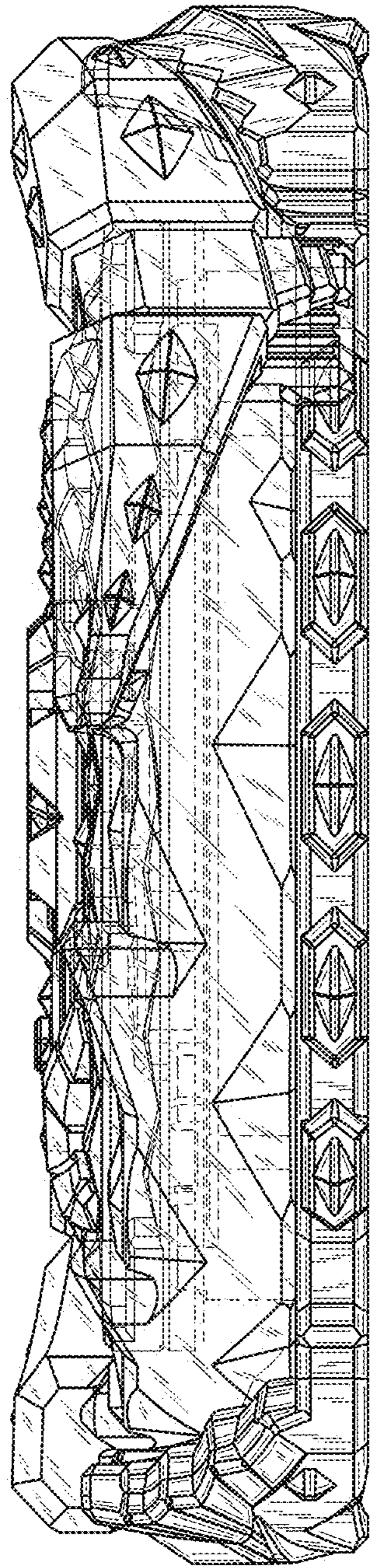

FIG. 2

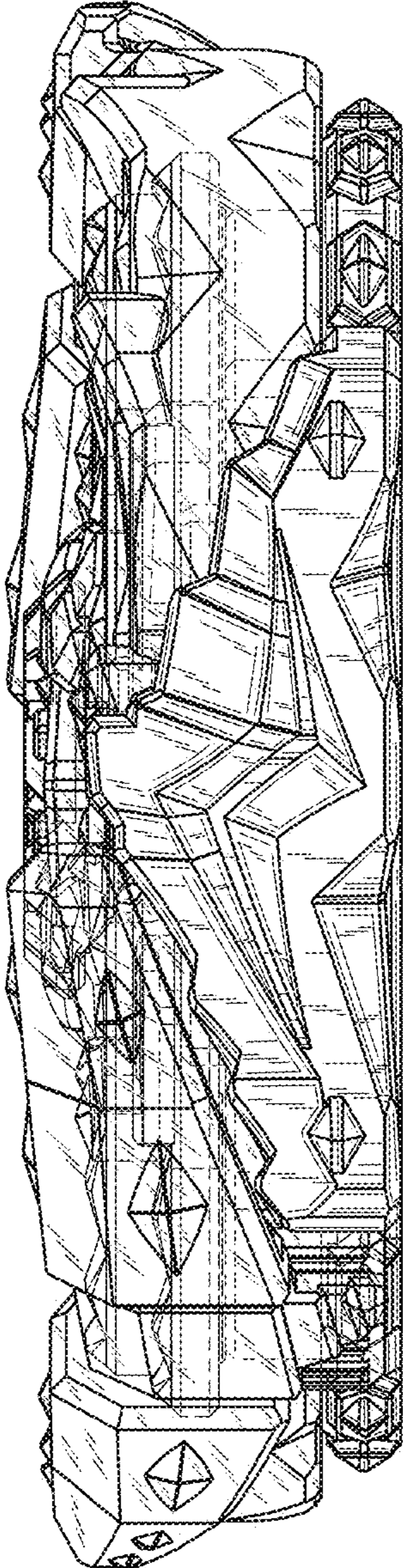

FIG. 3

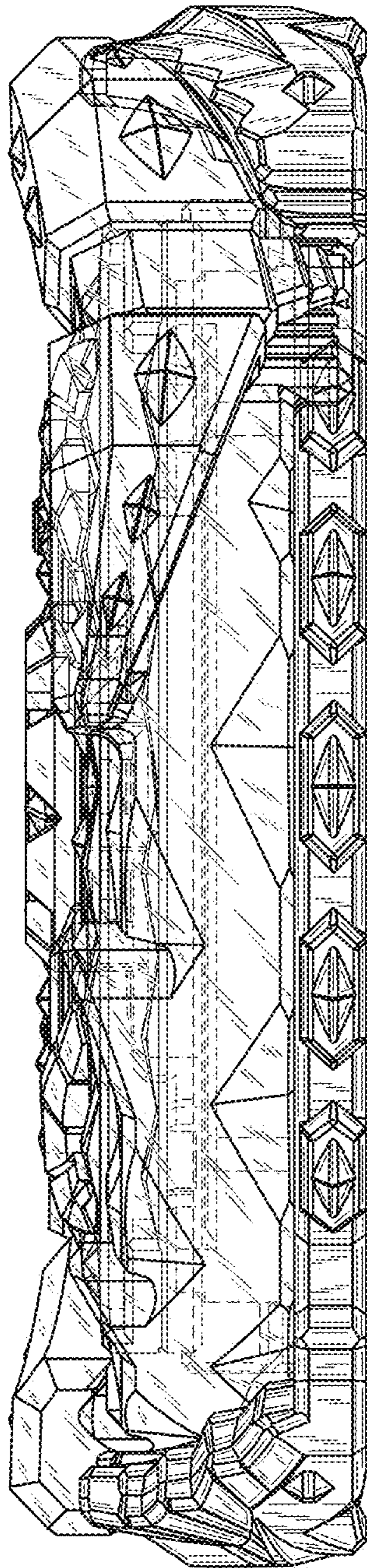

FIG. 4

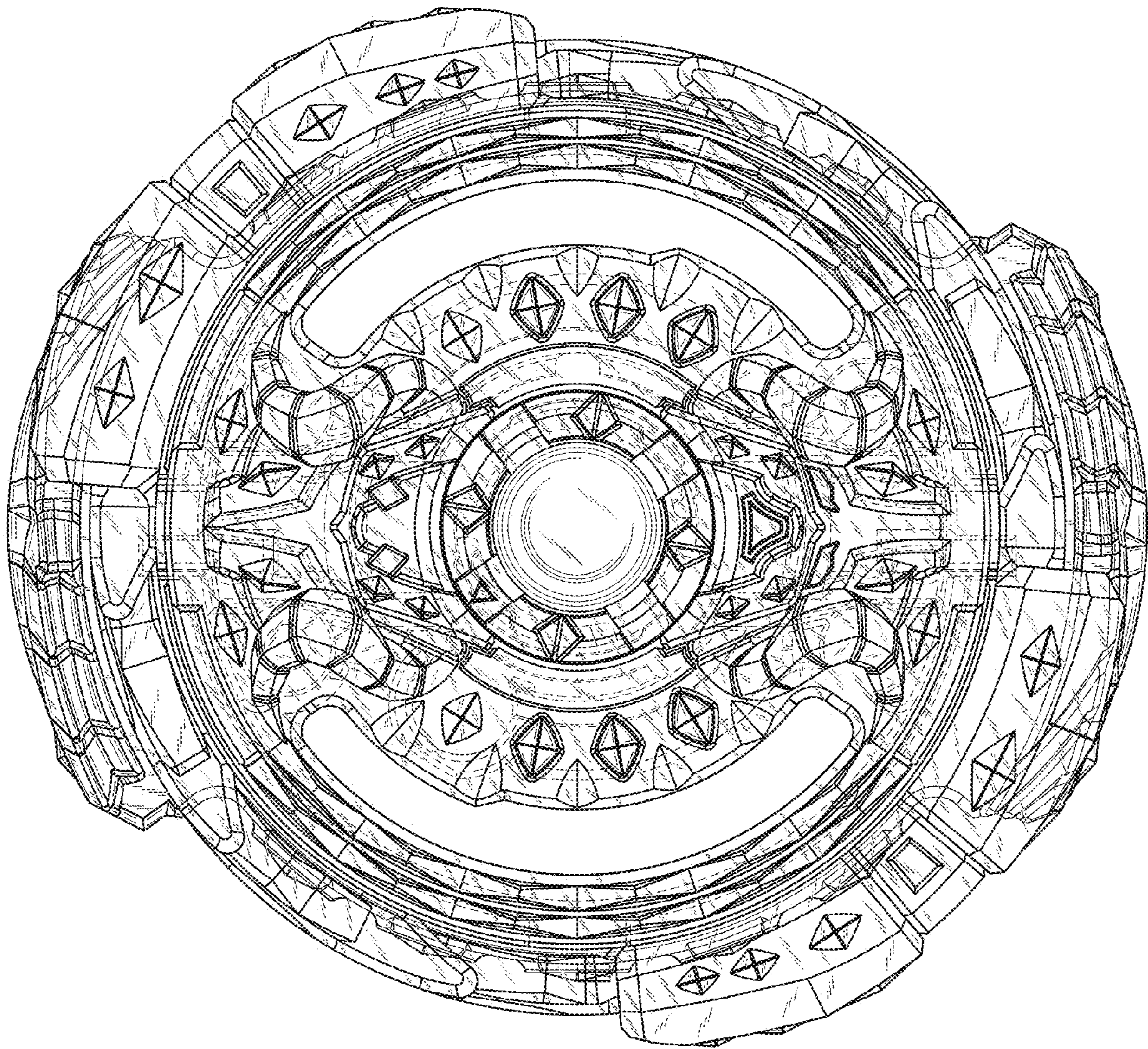

FIG. 5

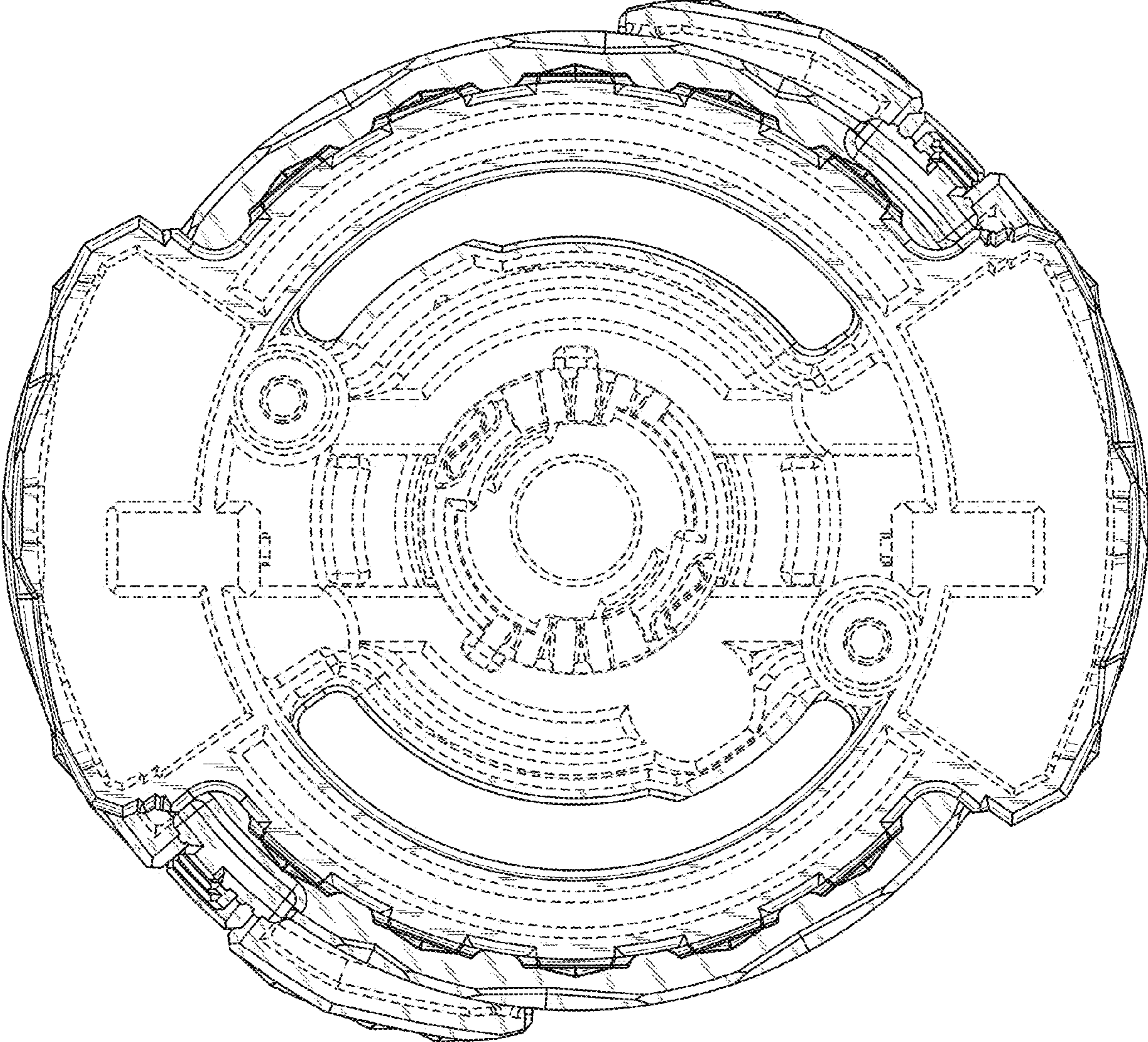

FIG. 6

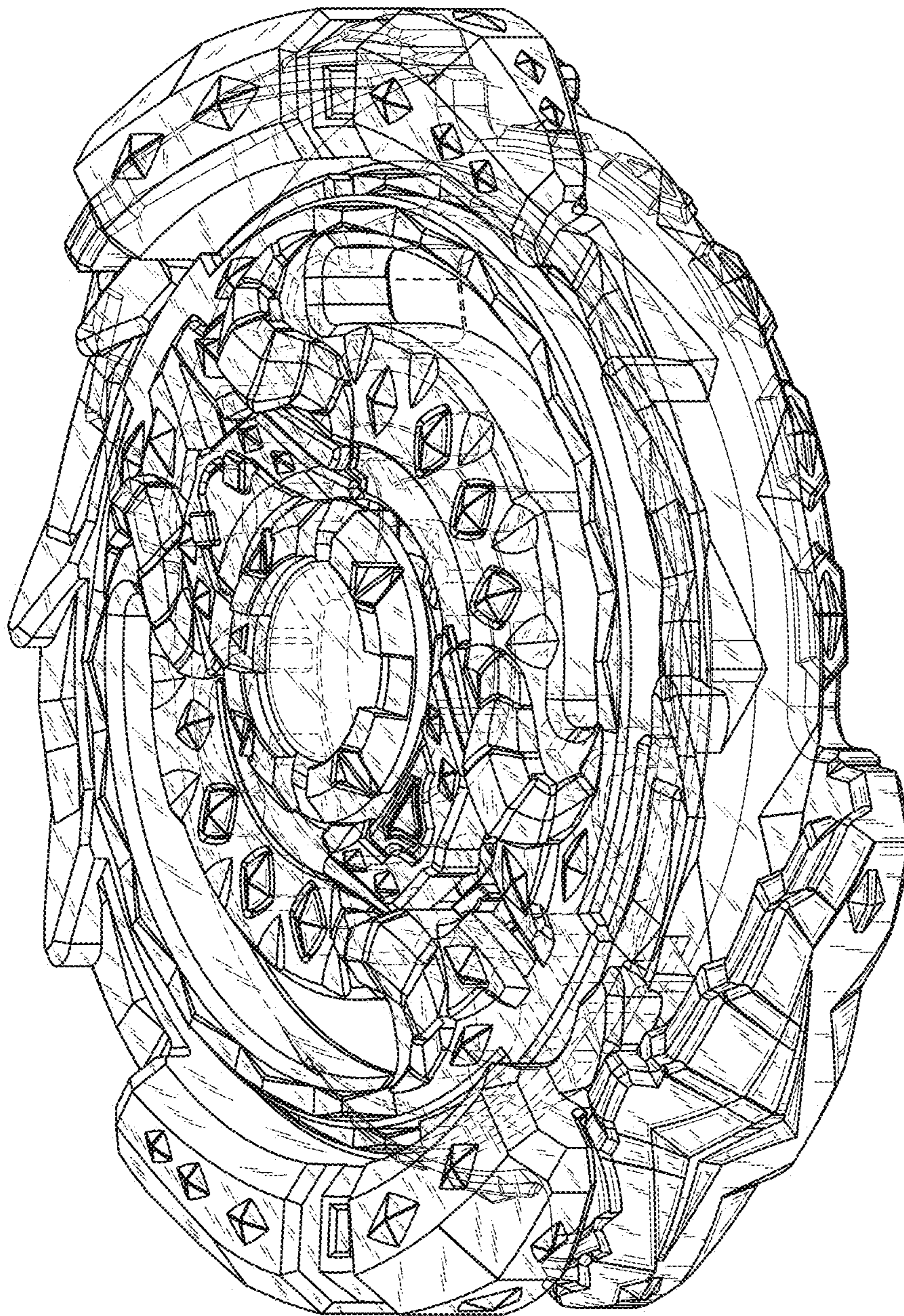

FIG. 7

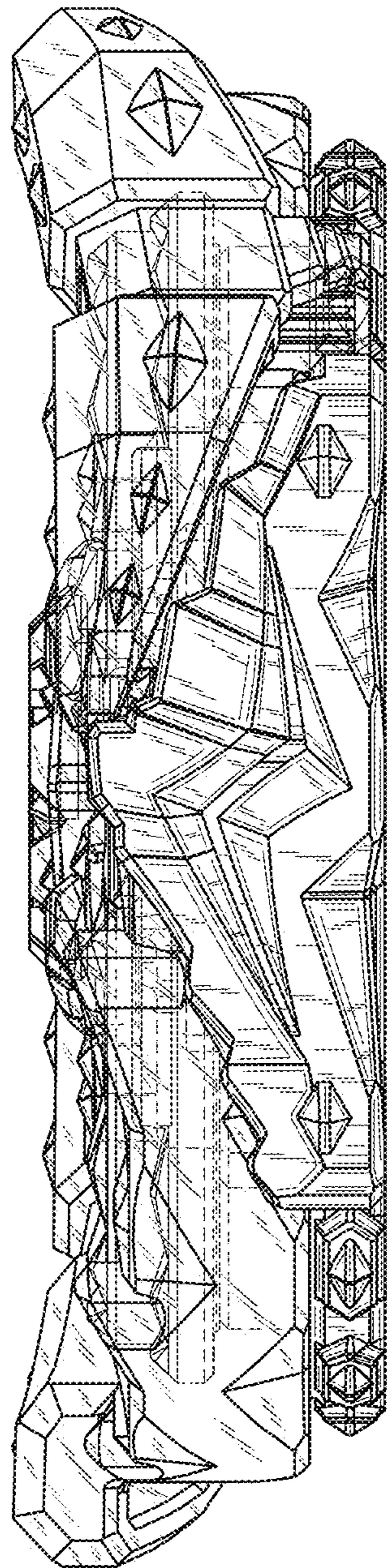

FIG. 8

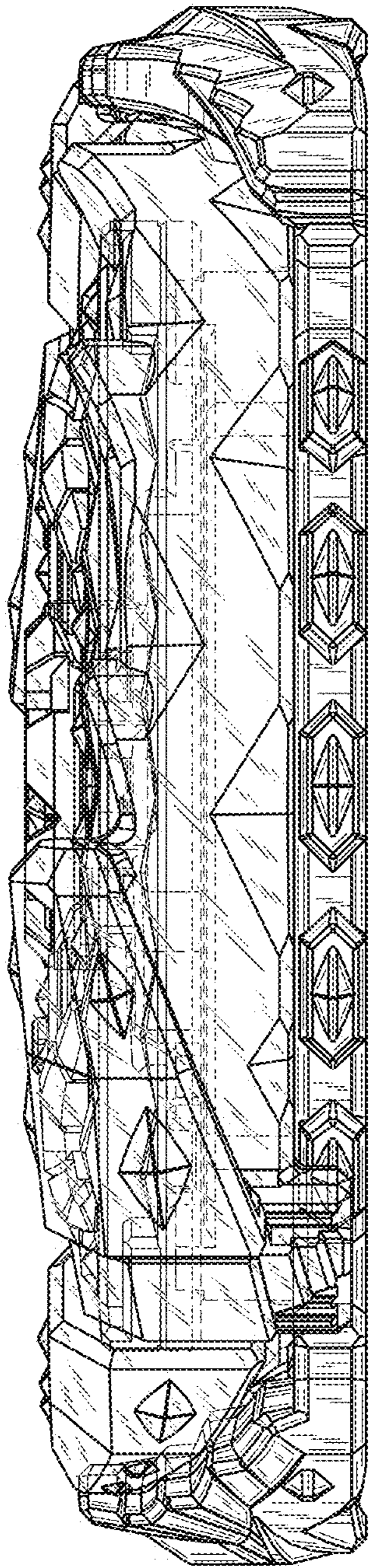

FIG. 9

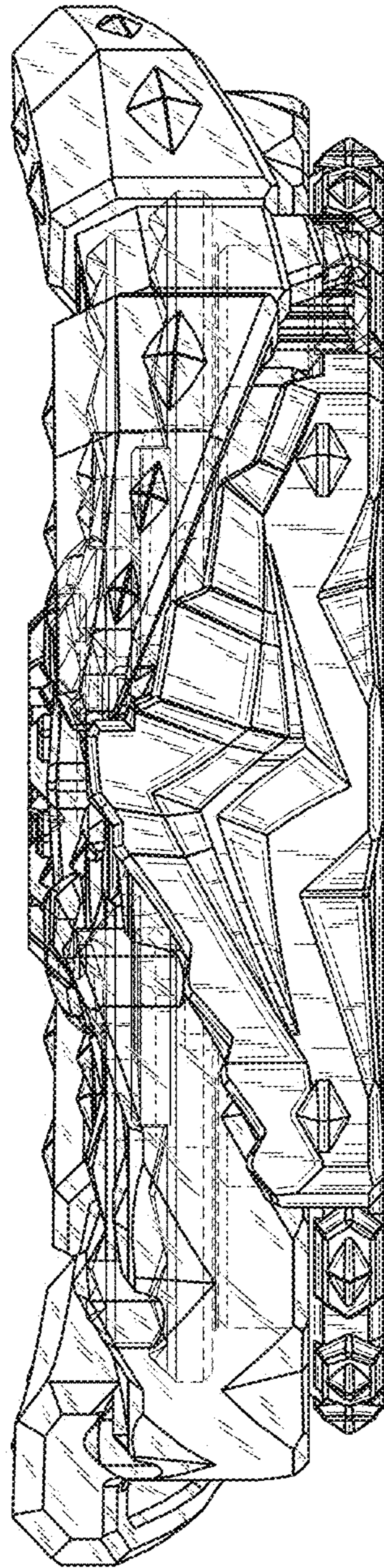

FIG. 10

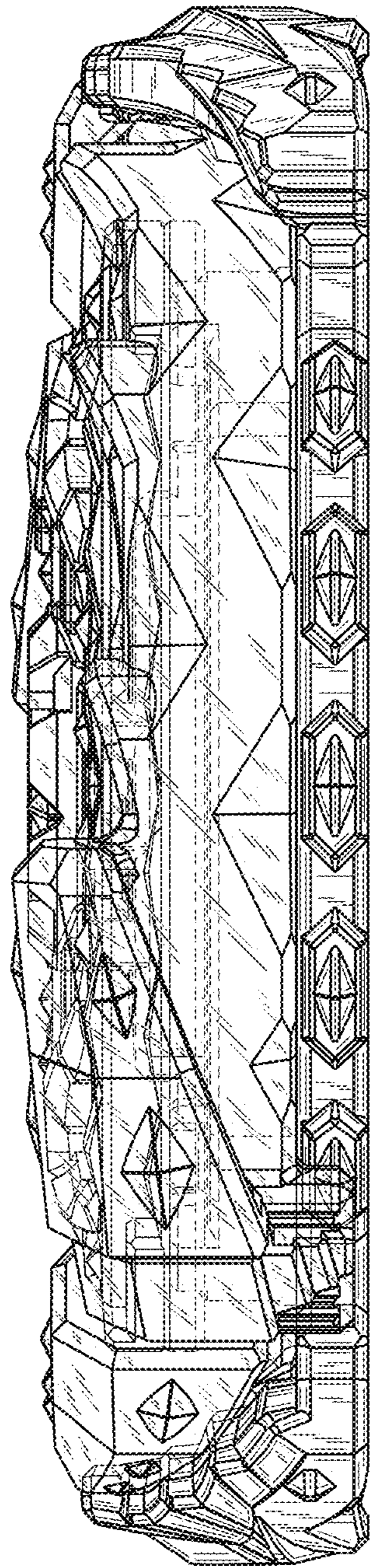

FIG. 11

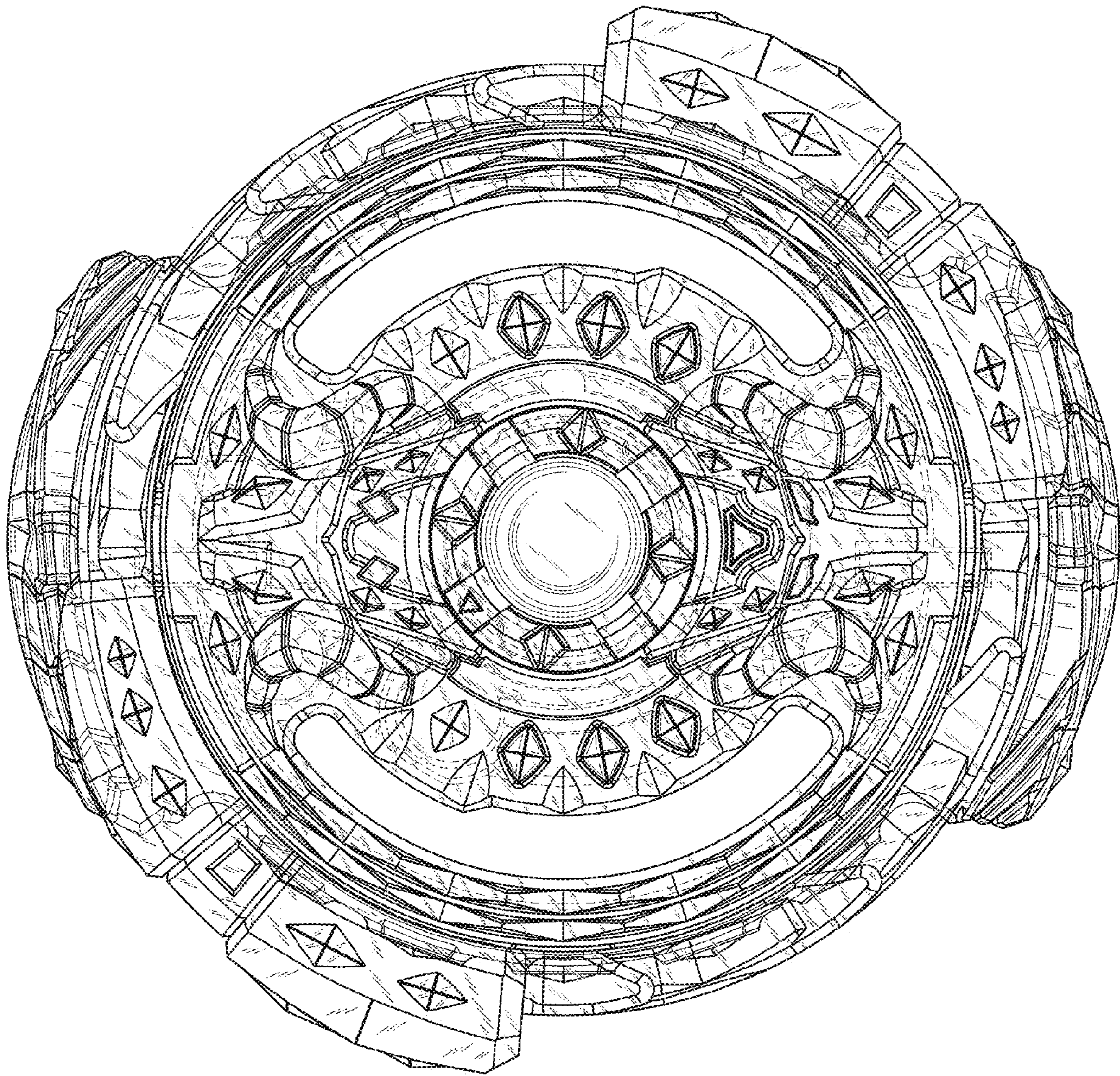

FIG. 12

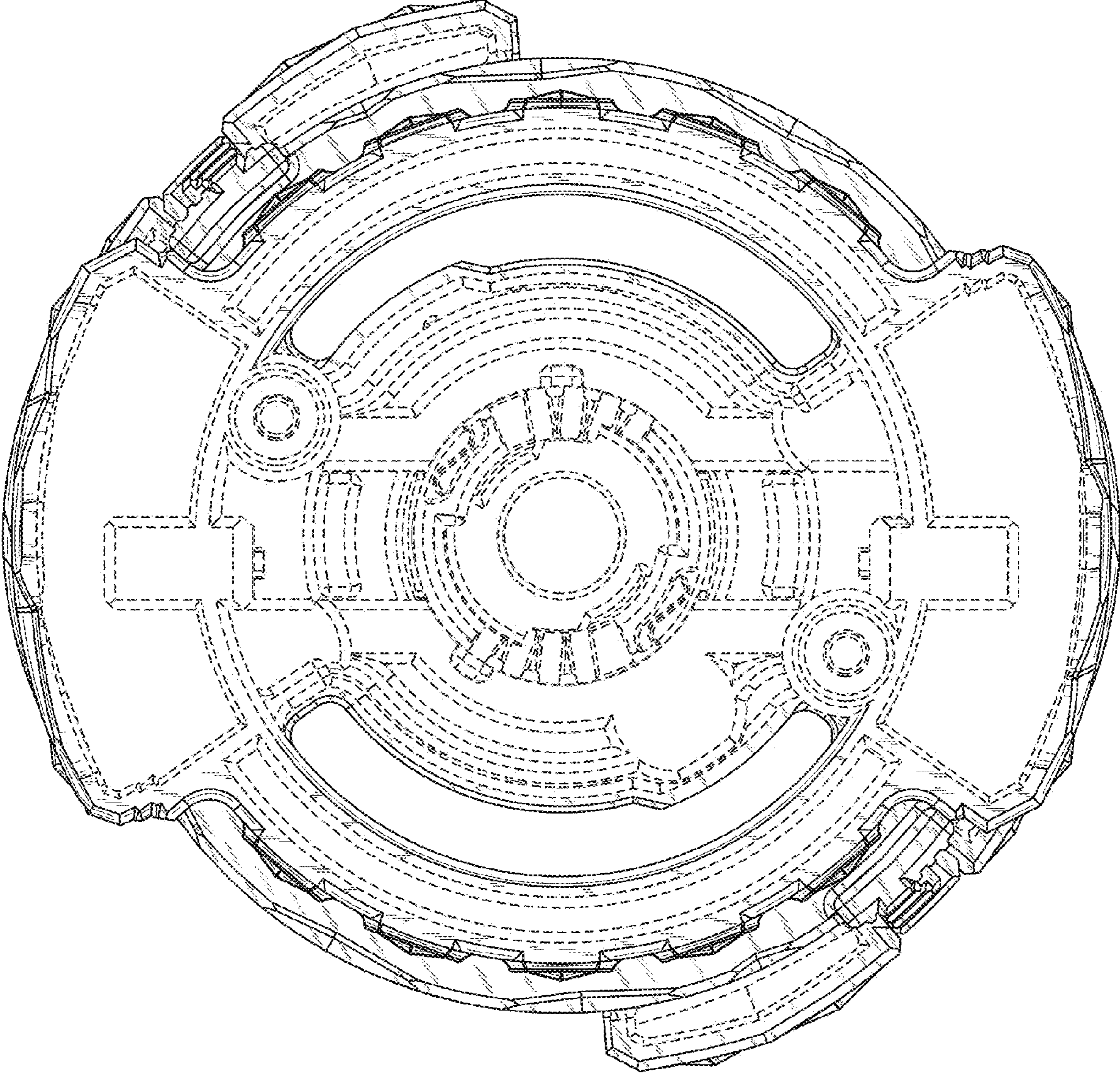

FIG. 13

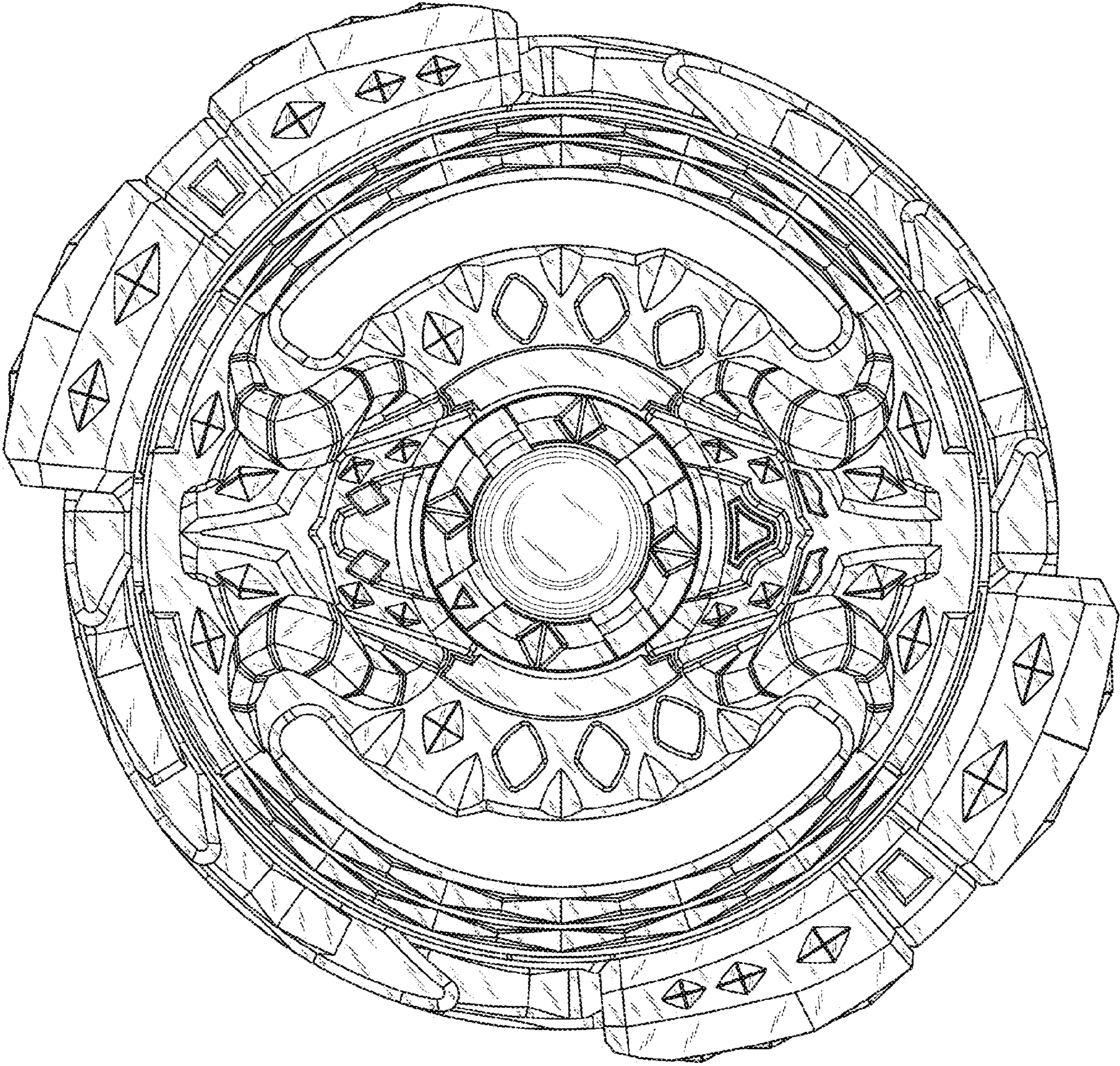

FIG. 14

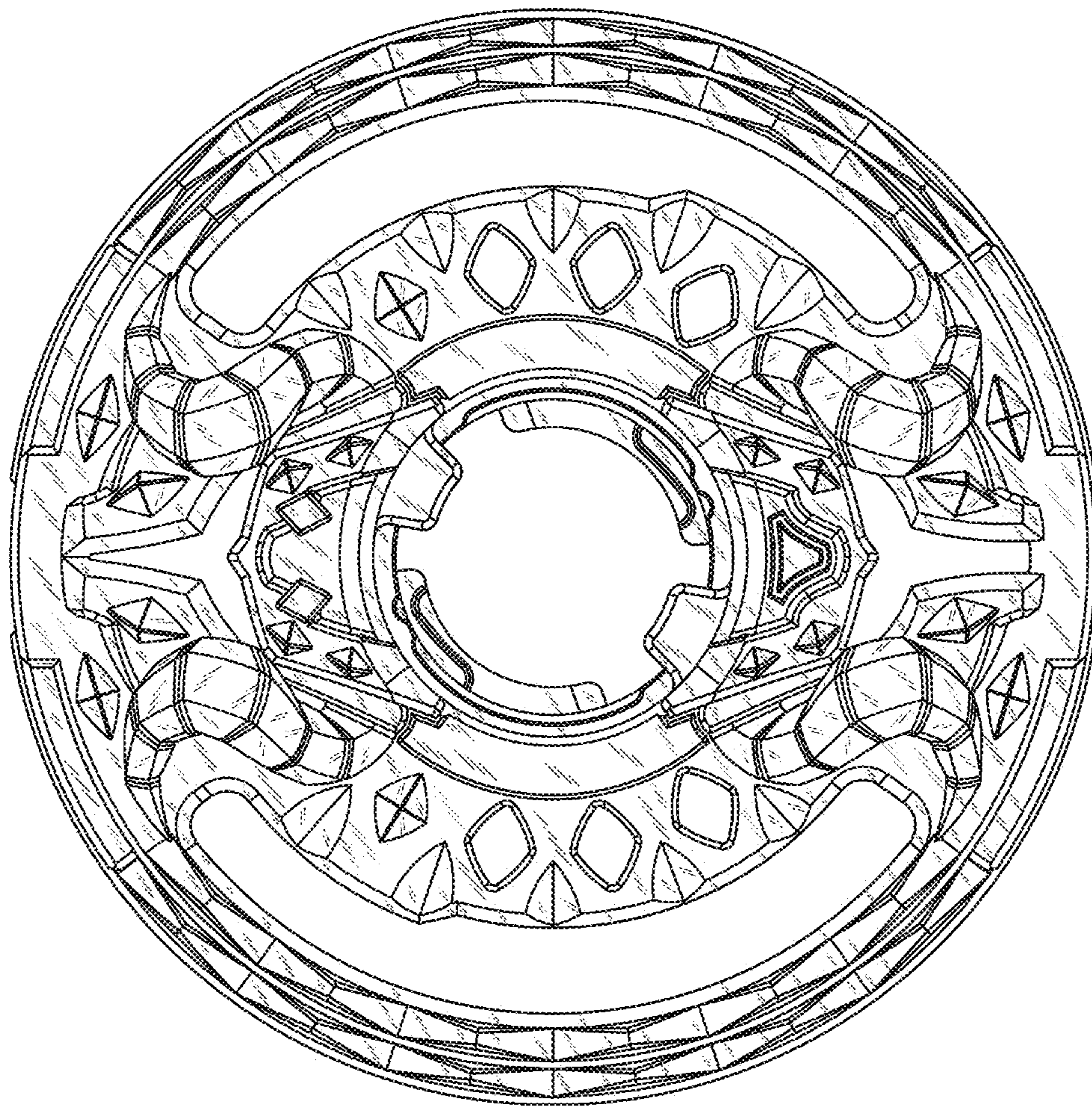

FIG. 15

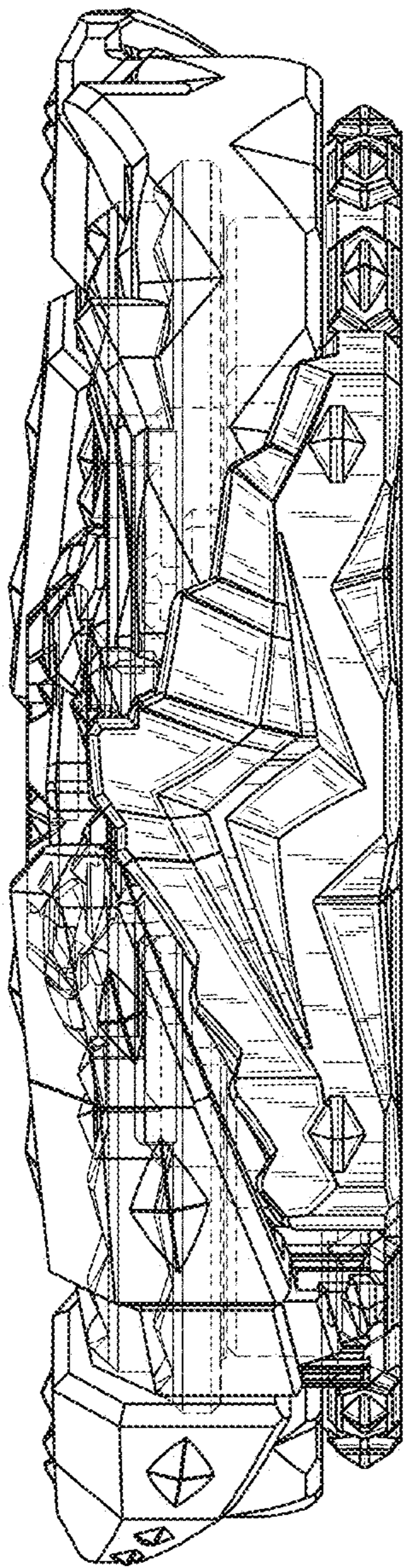

FIG. 16

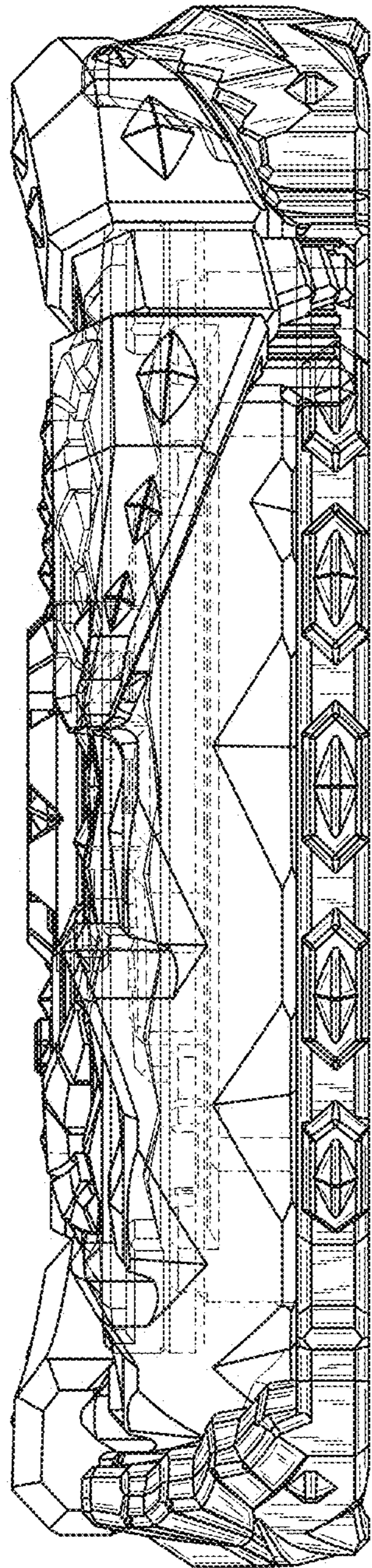

FIG. 17

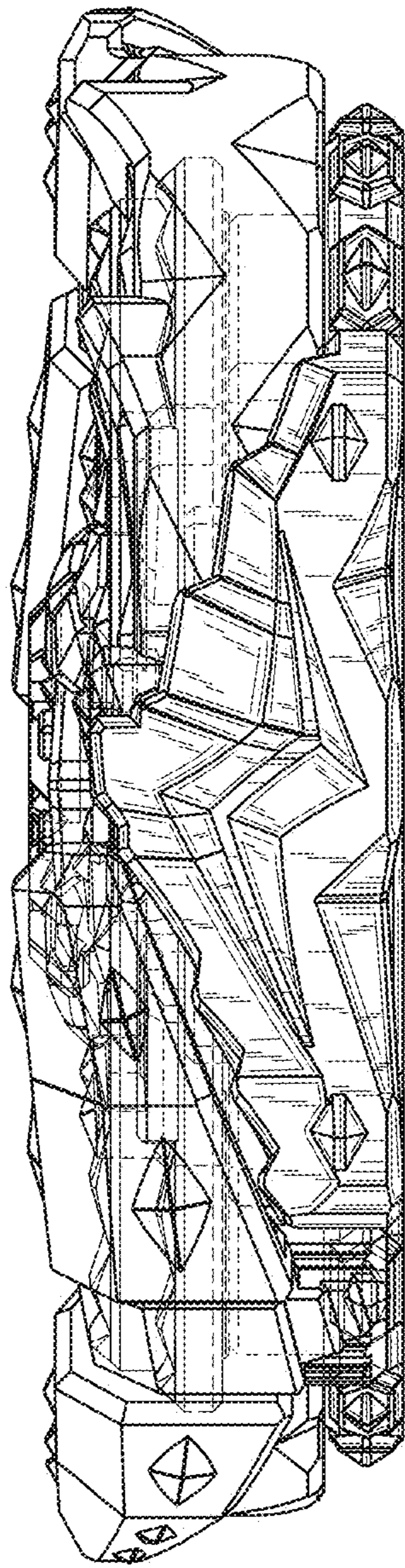

FIG. 18

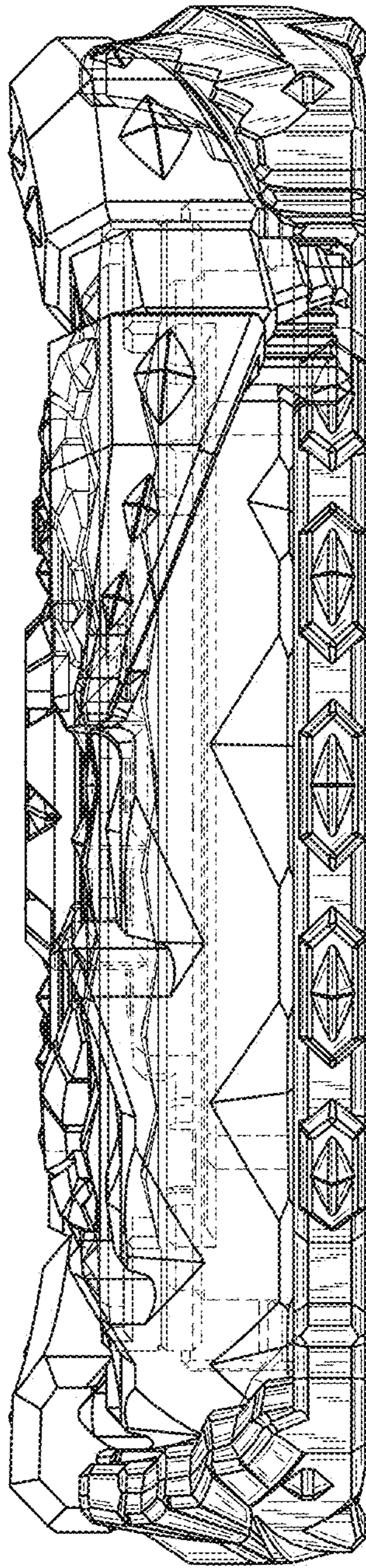

FIG. 19

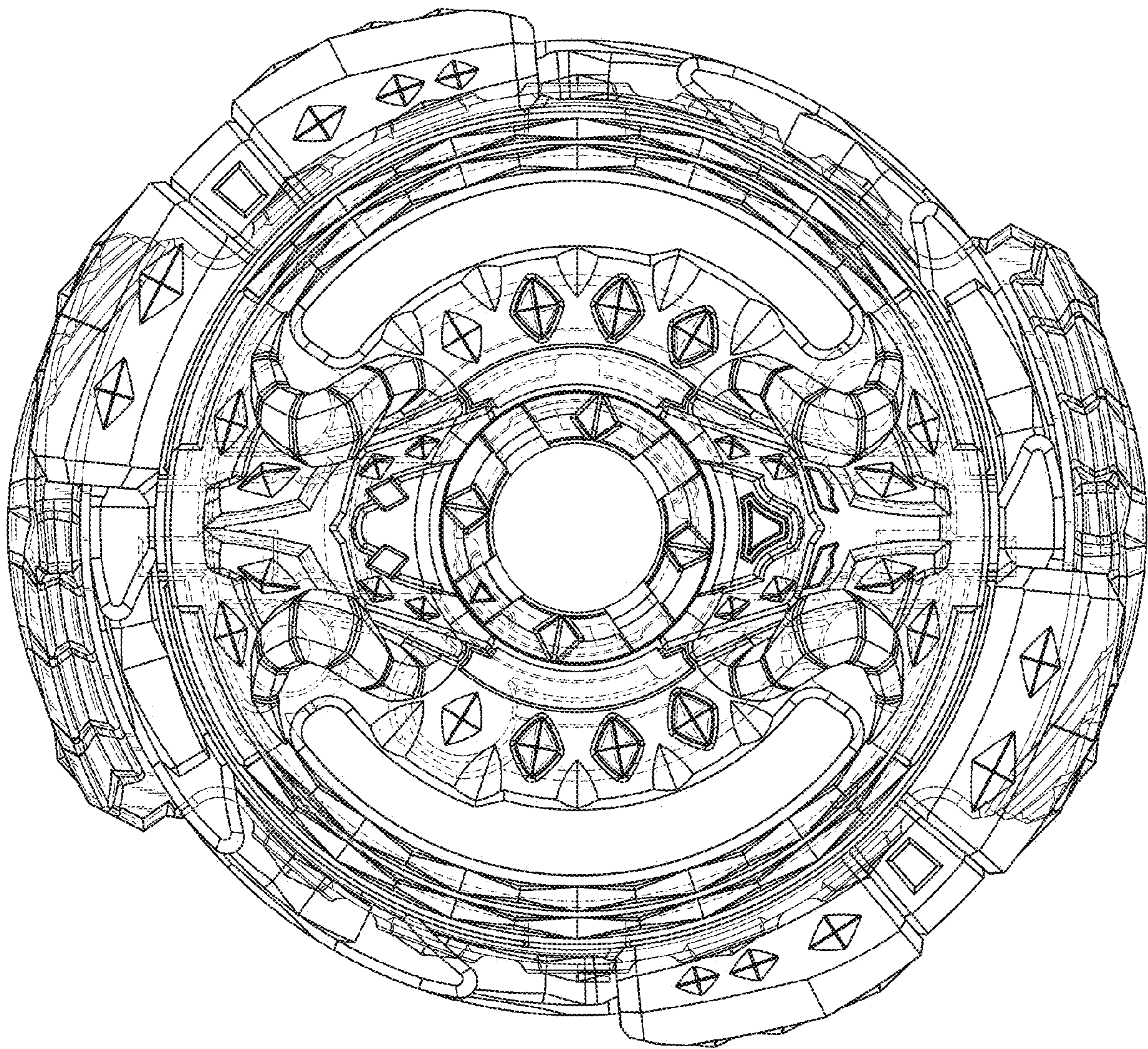

FIG. 20

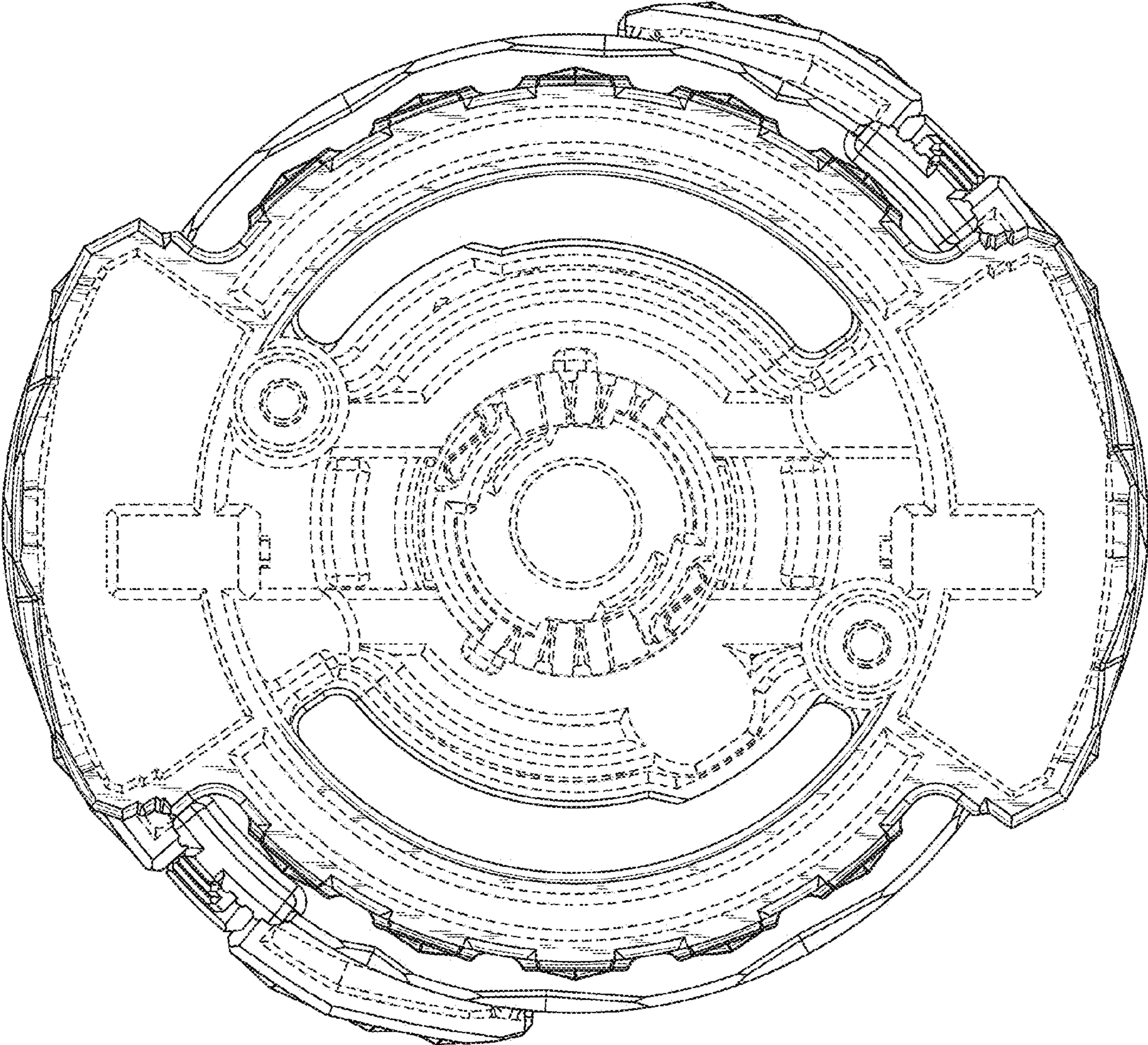
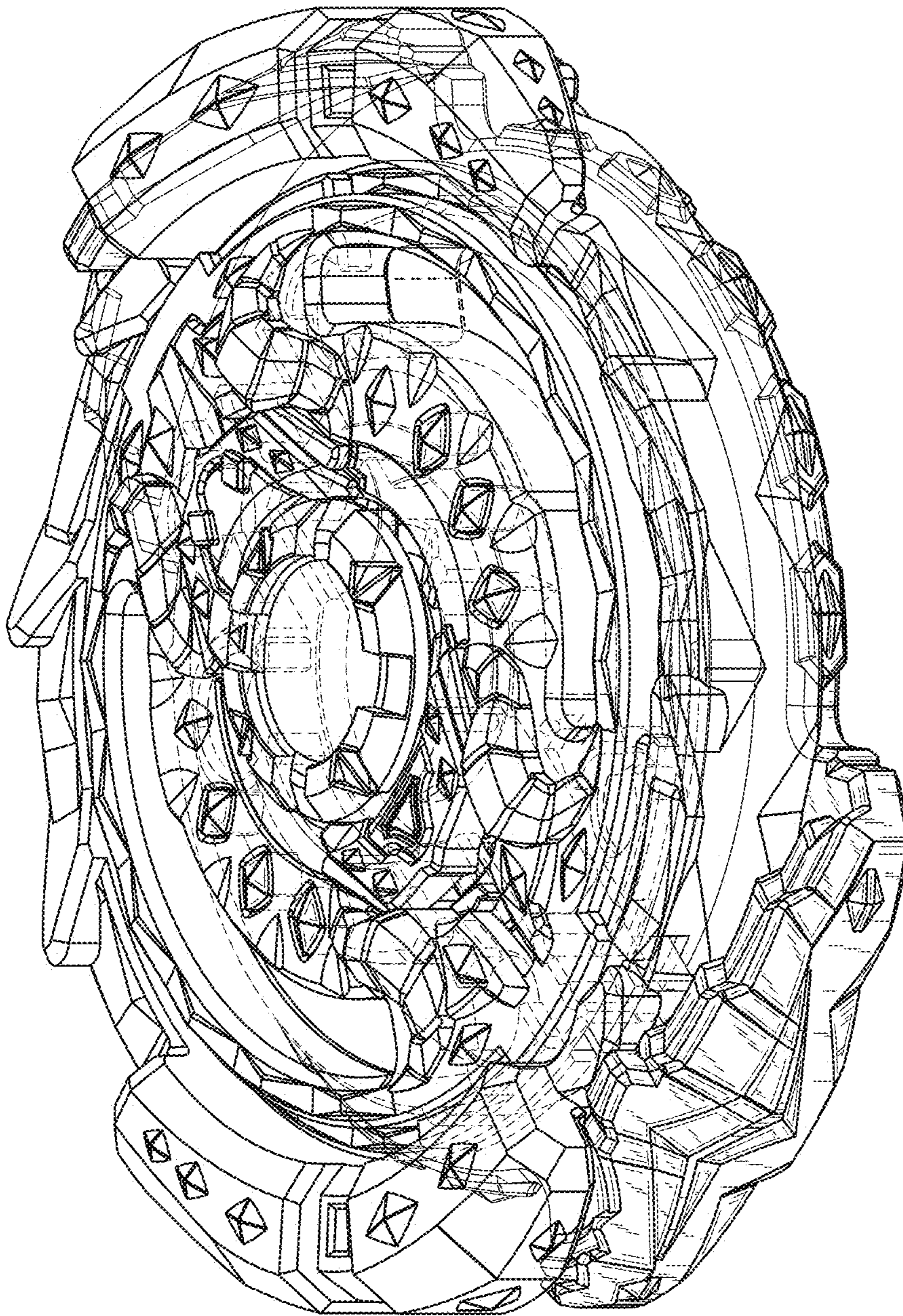

FIG. 21

FIG. 22



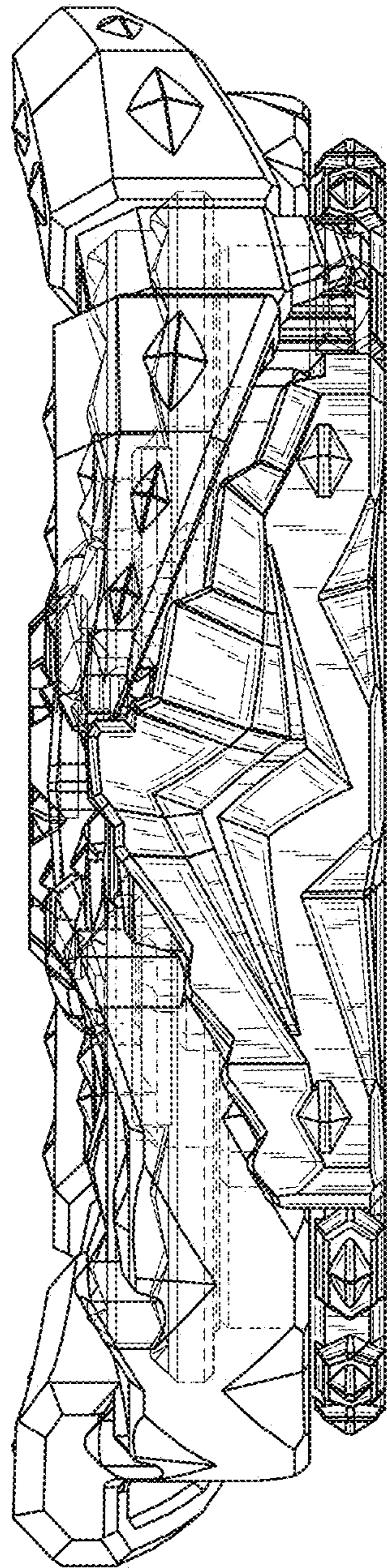

FIG. 23

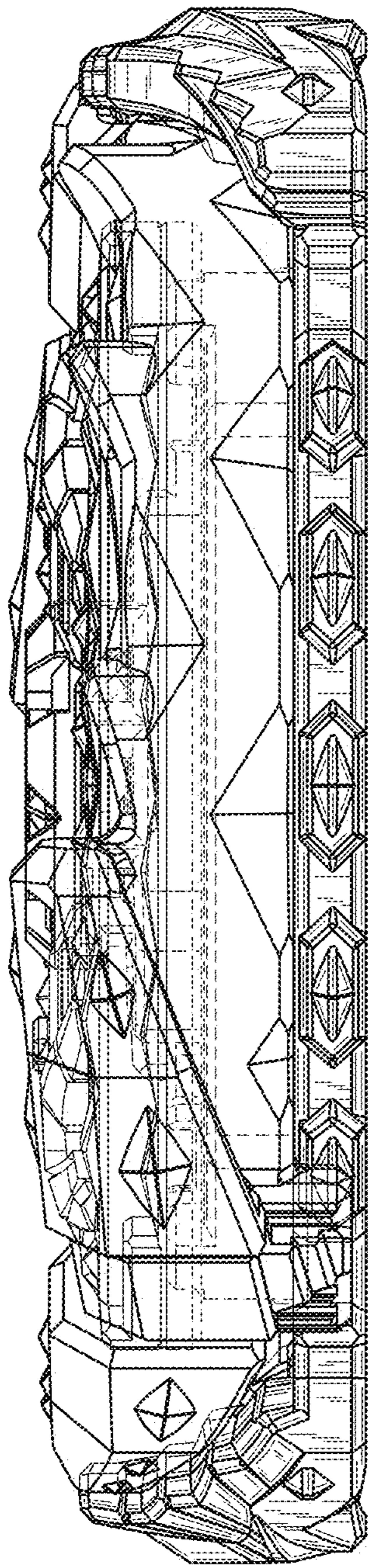

FIG. 24

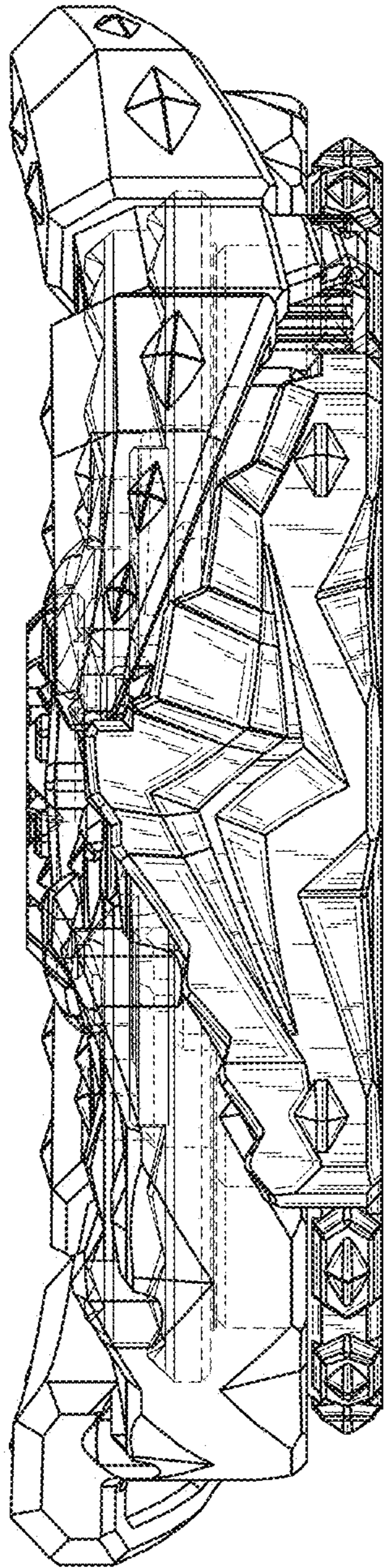

FIG. 25

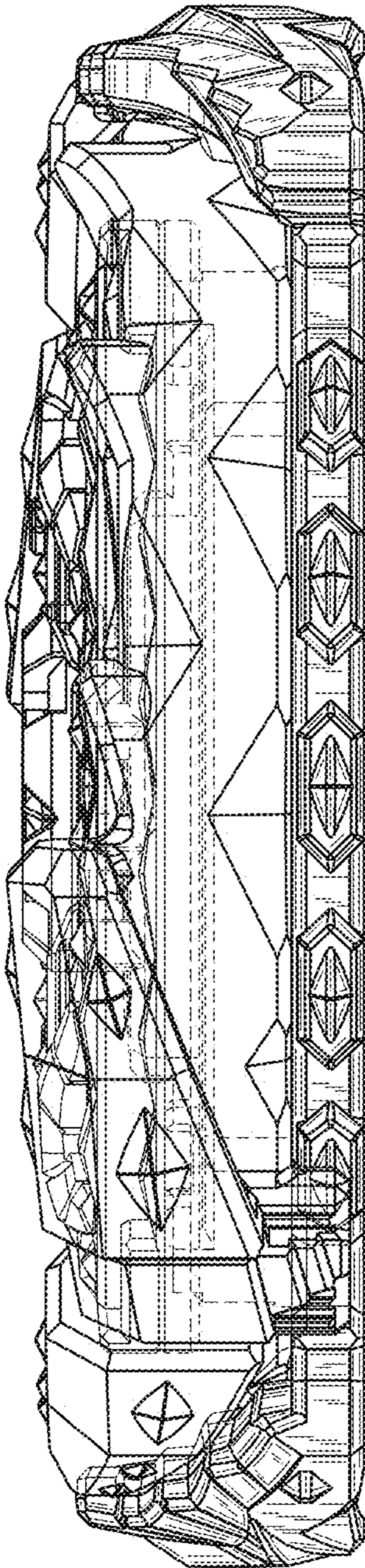

FIG. 26

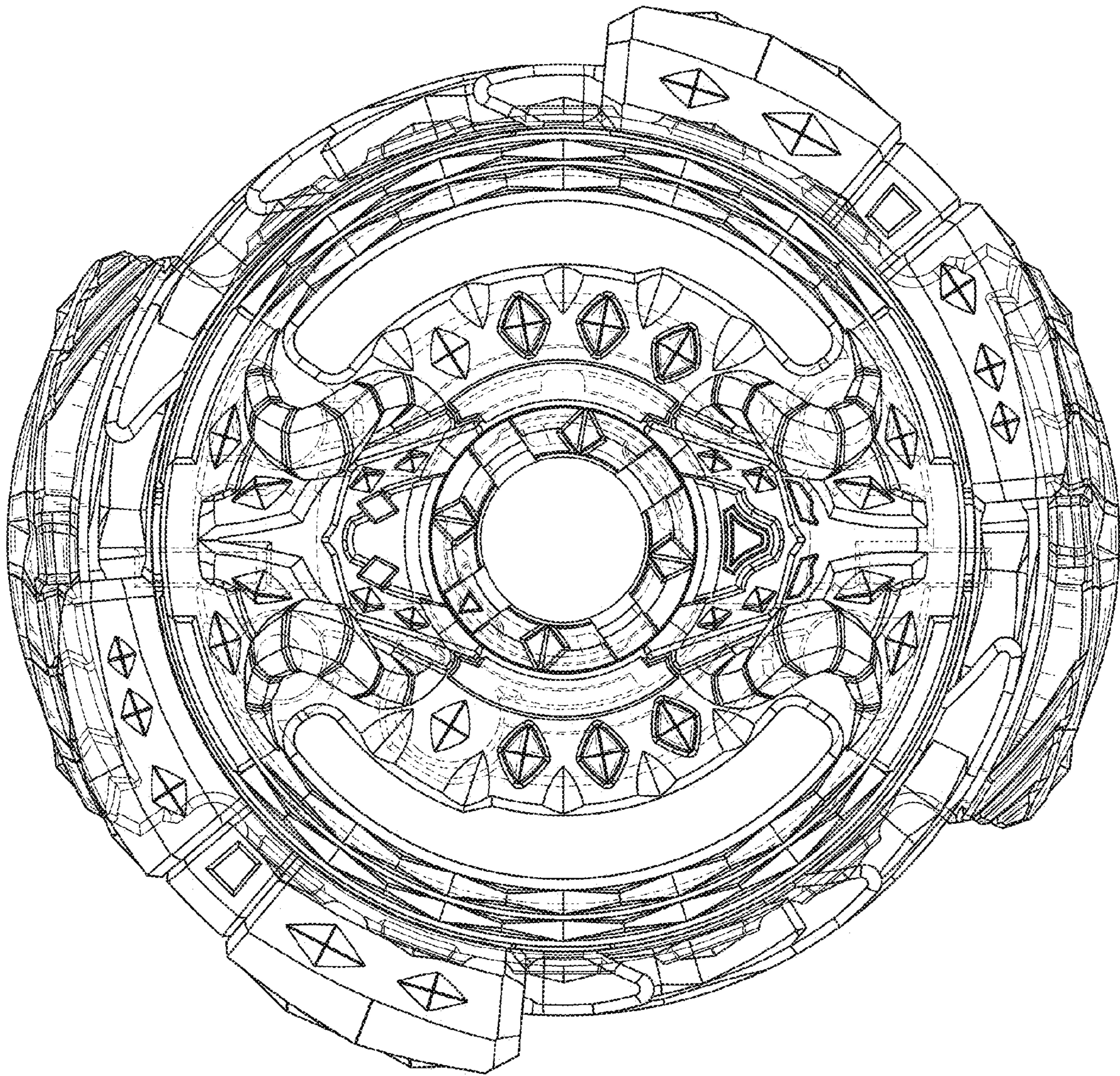

FIG. 27

FIG. 28

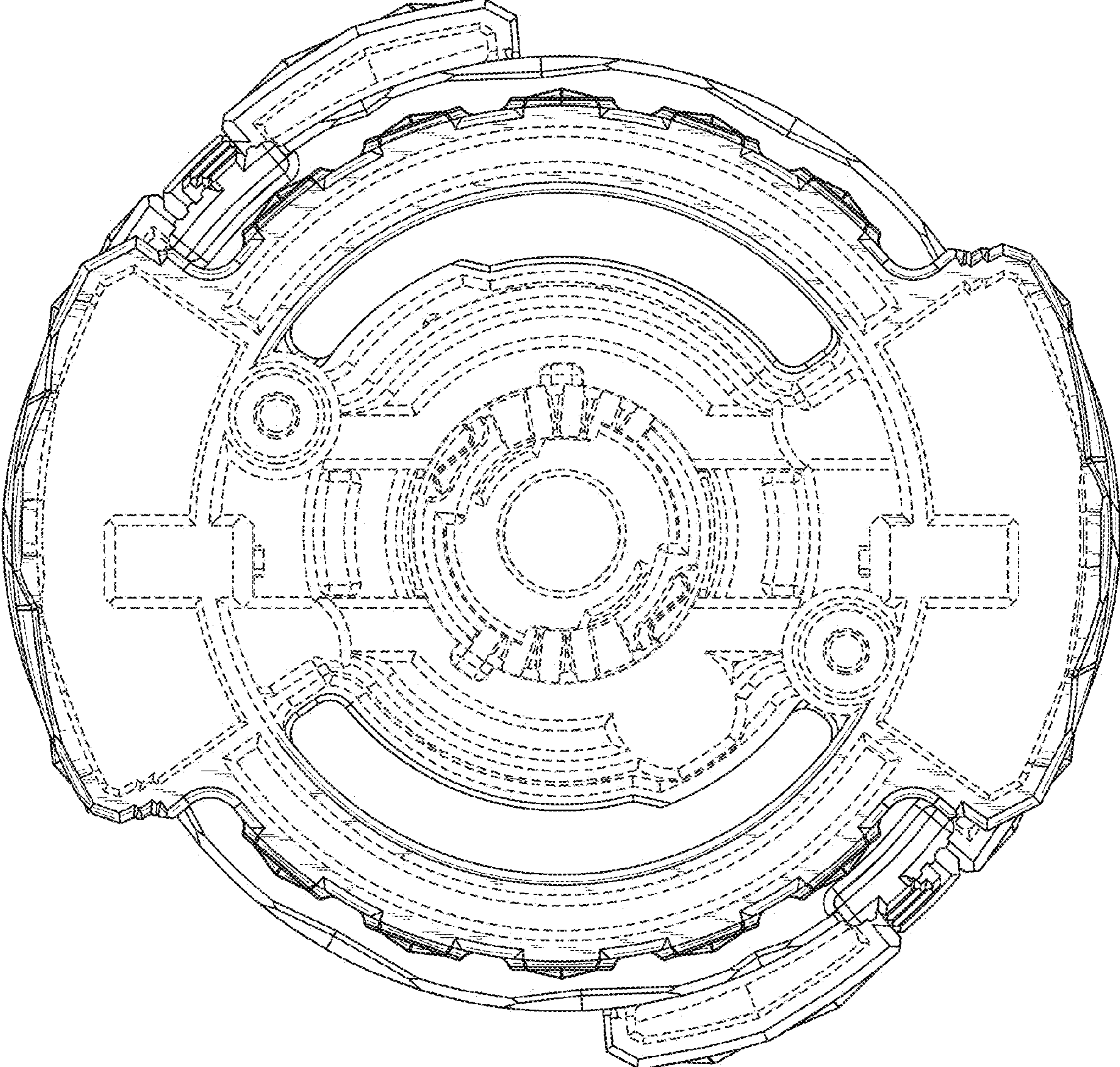
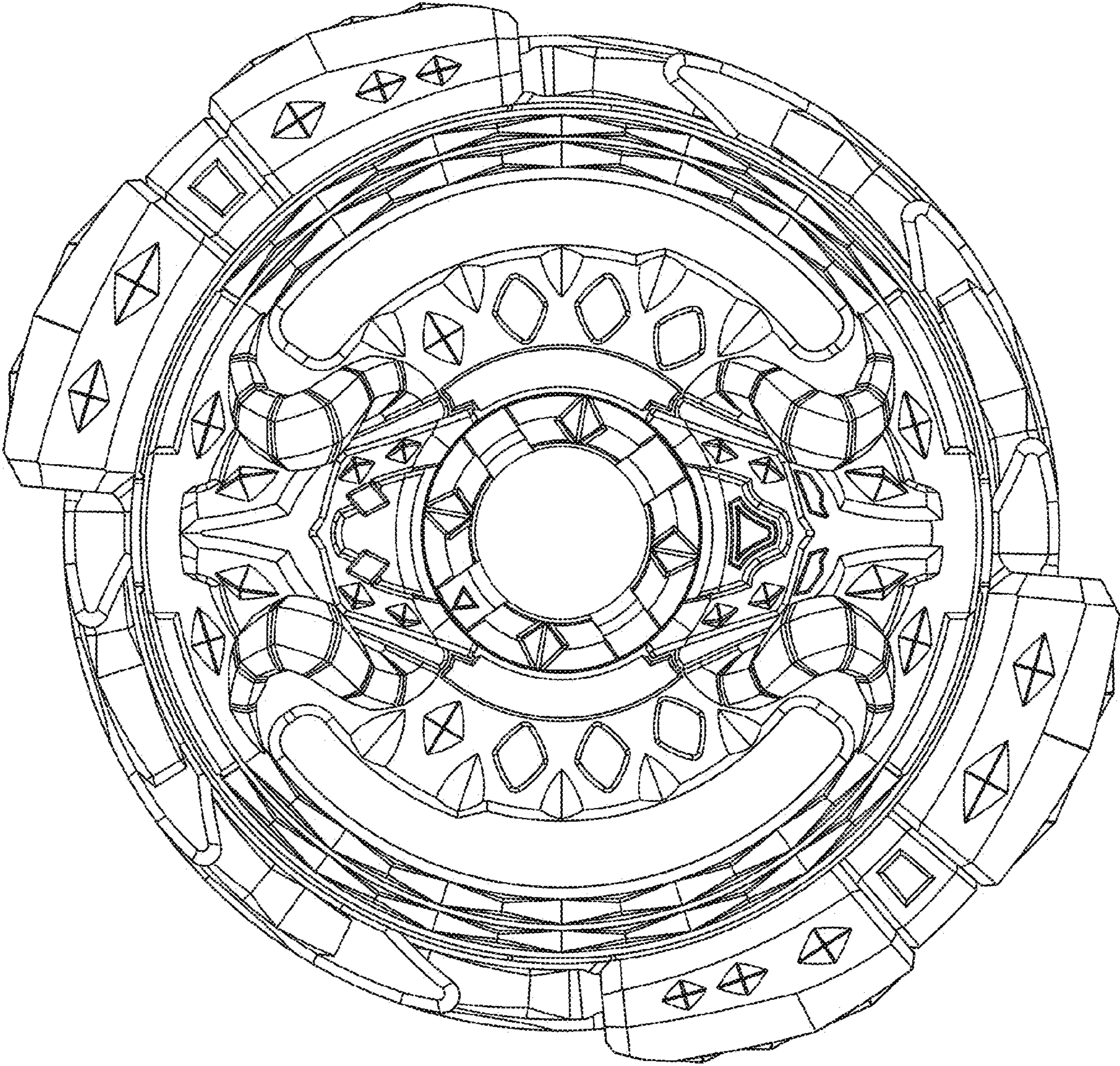

FIG. 29



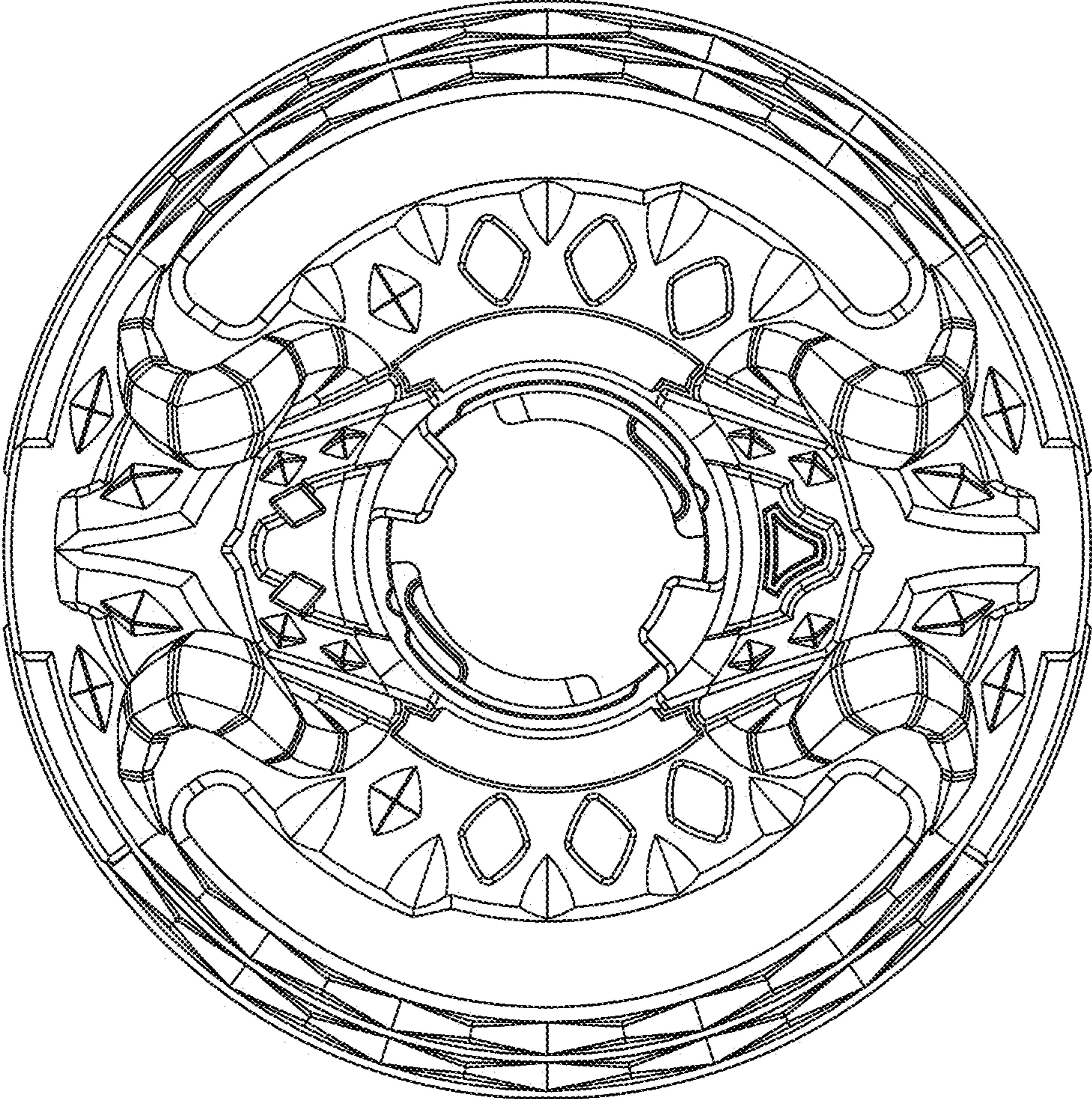

FIG. 30

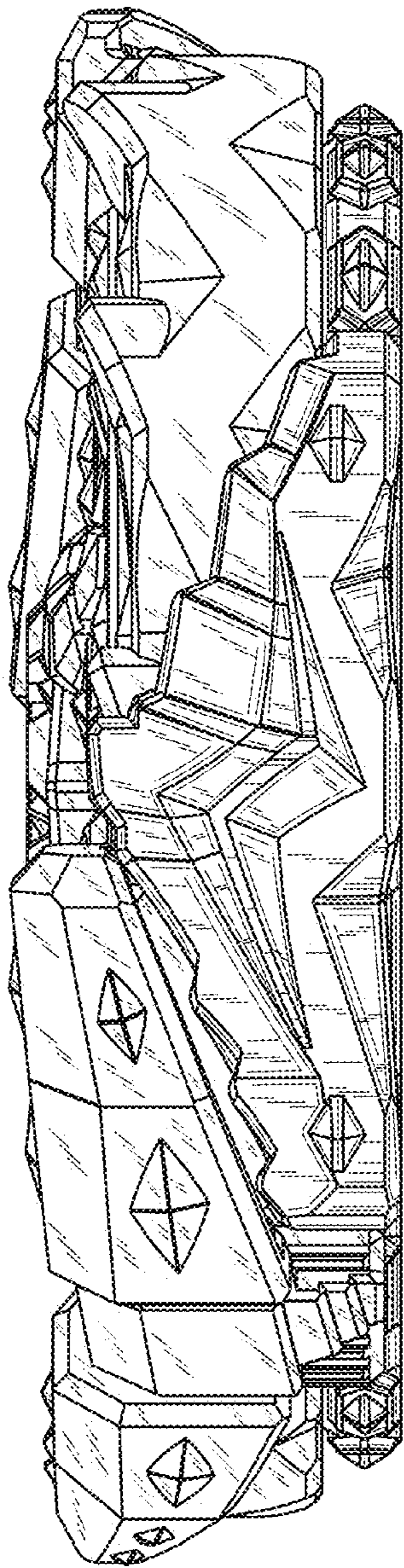

FIG. 31

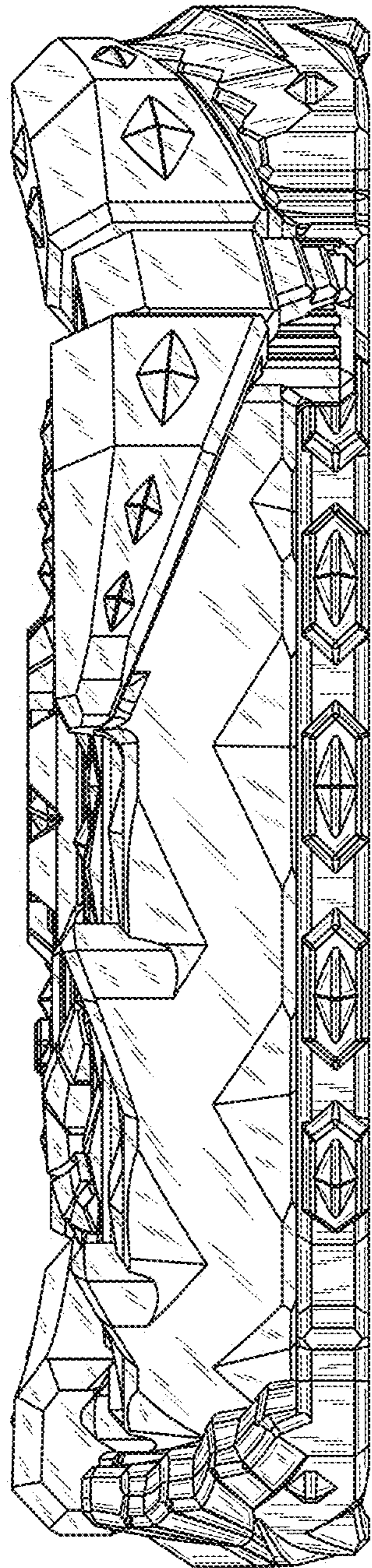

FIG. 32

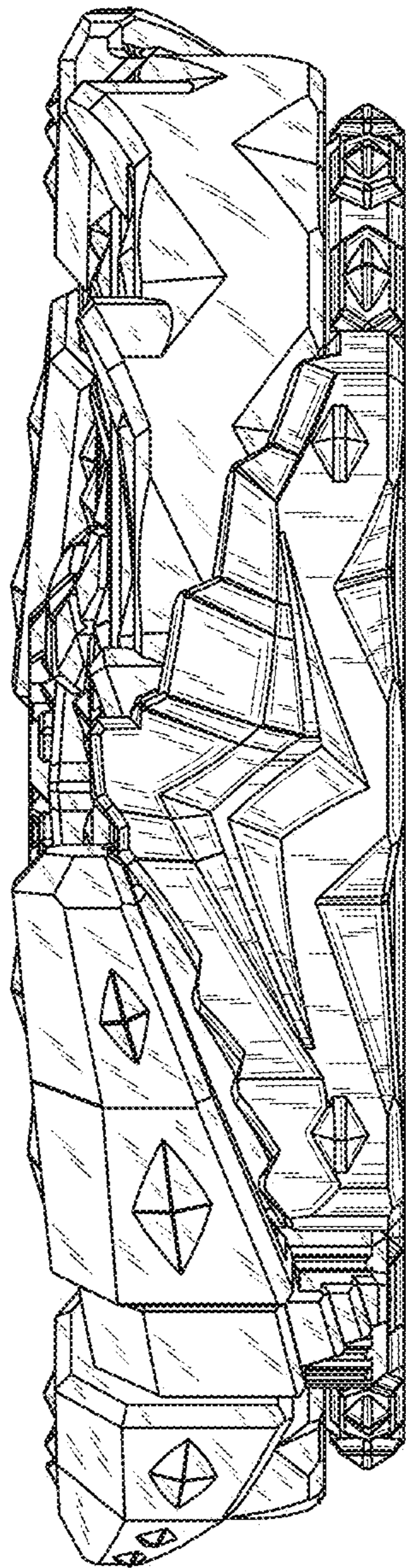

FIG. 33

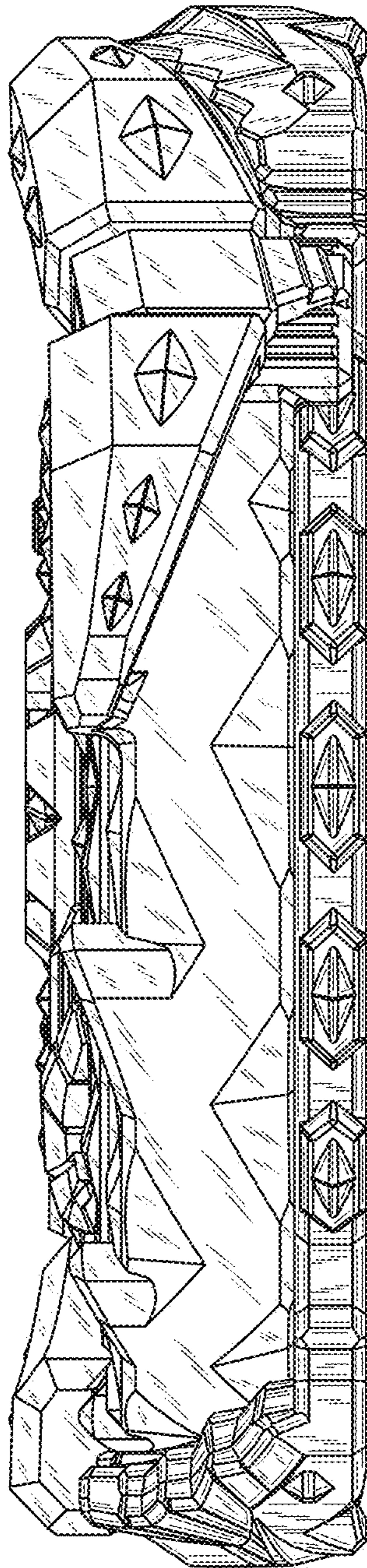

FIG. 34

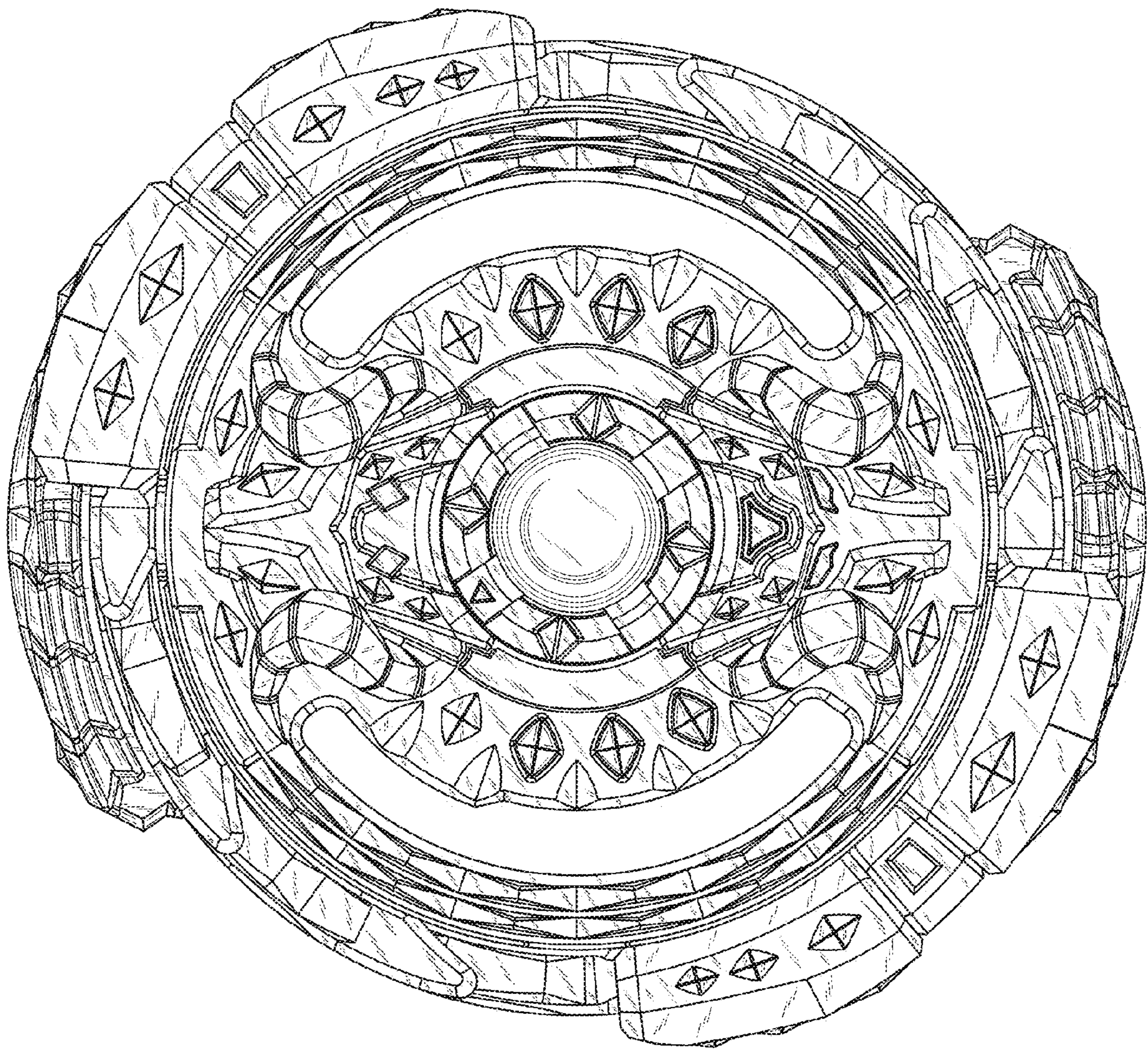

FIG. 35

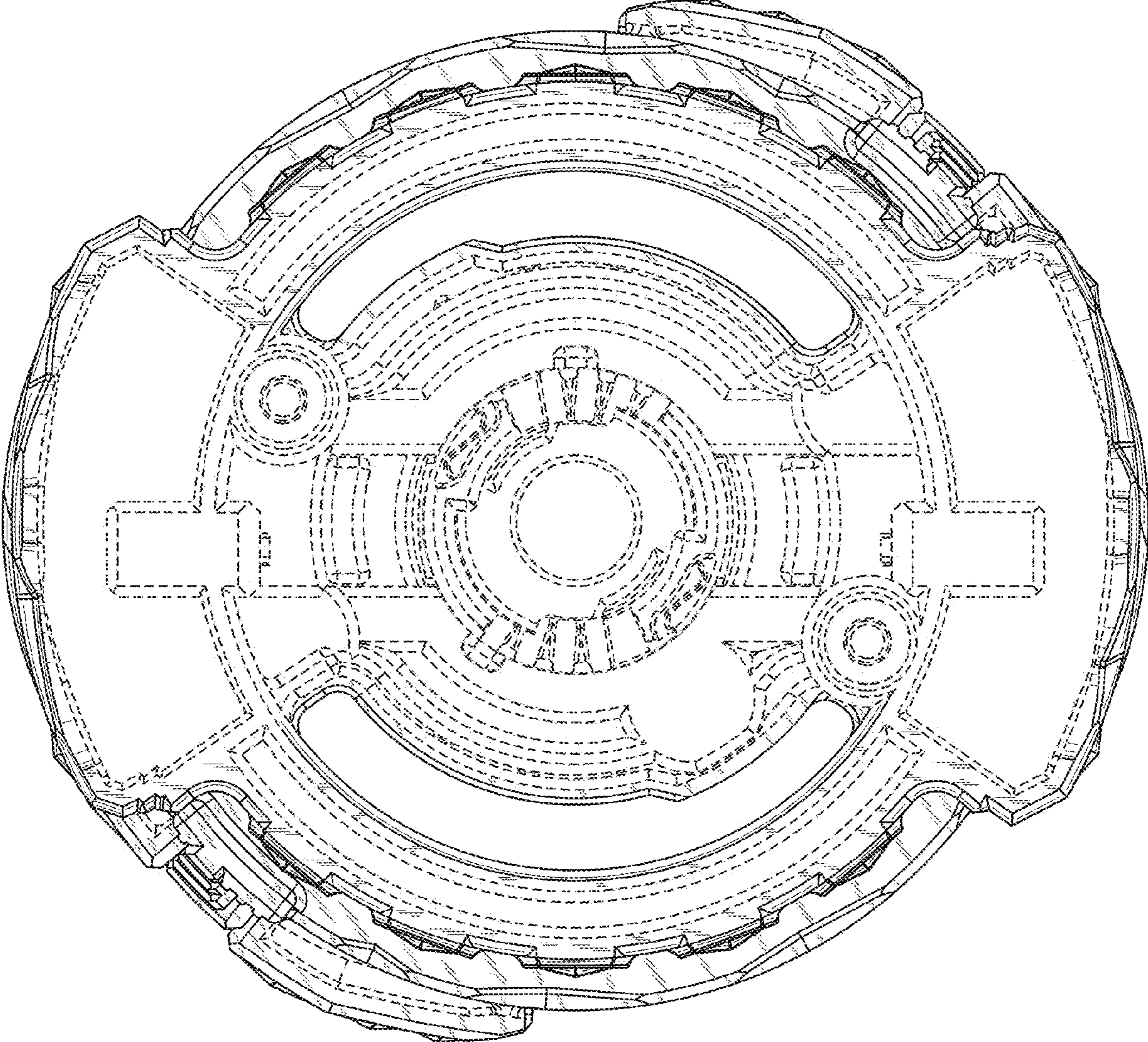
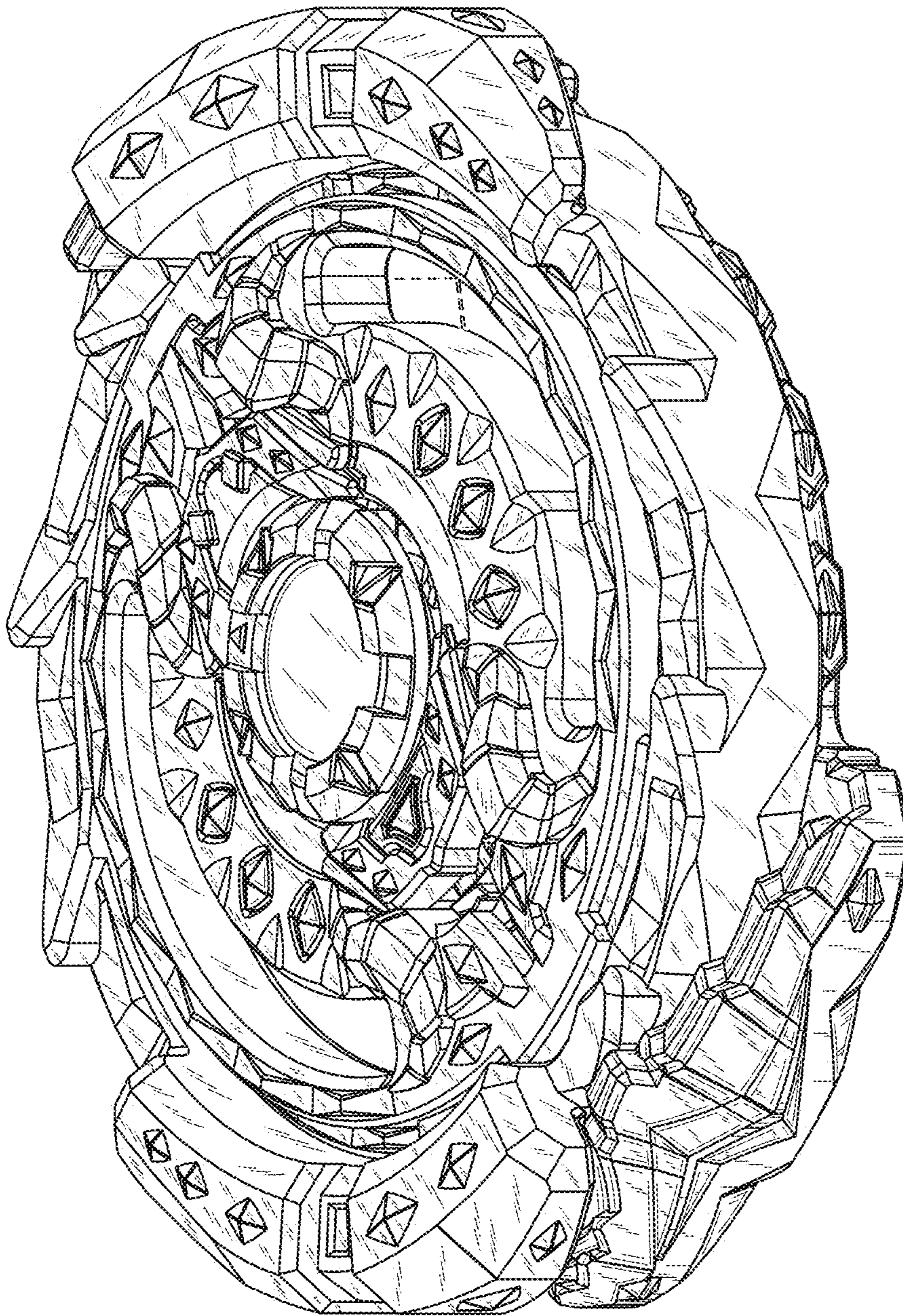

FIG. 36

FIG. 37



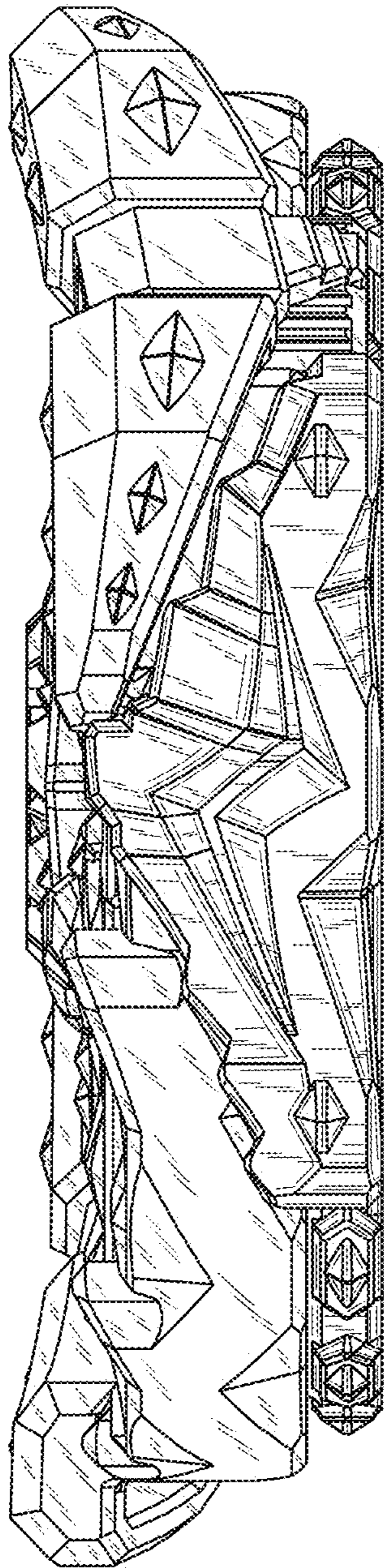

FIG. 38

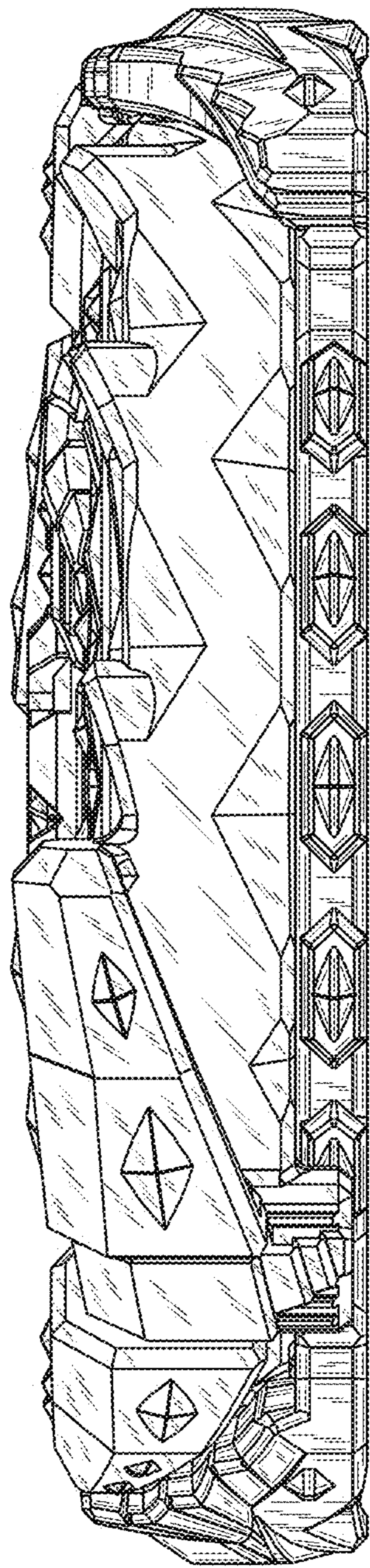

FIG. 39

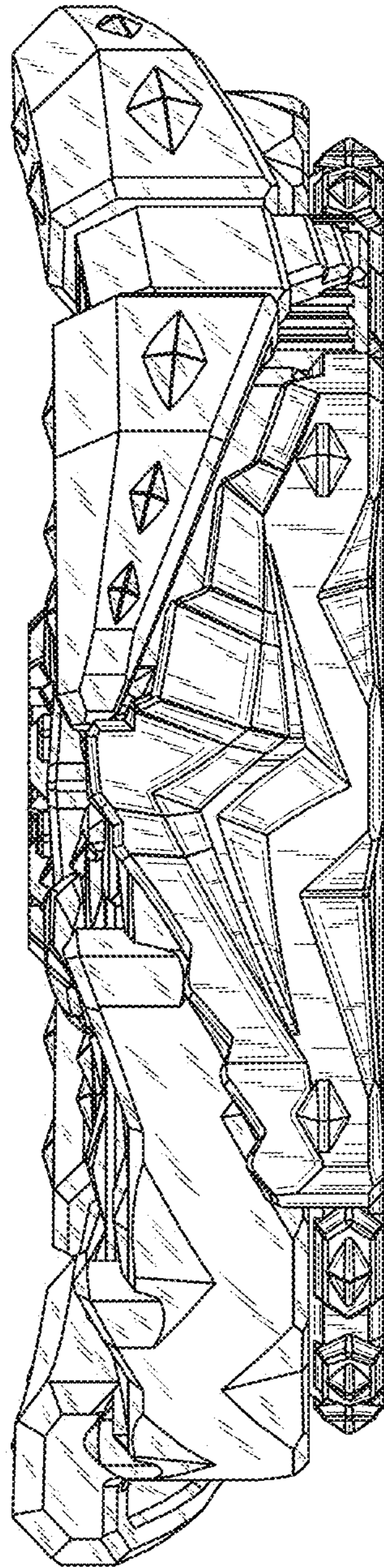

FIG. 40

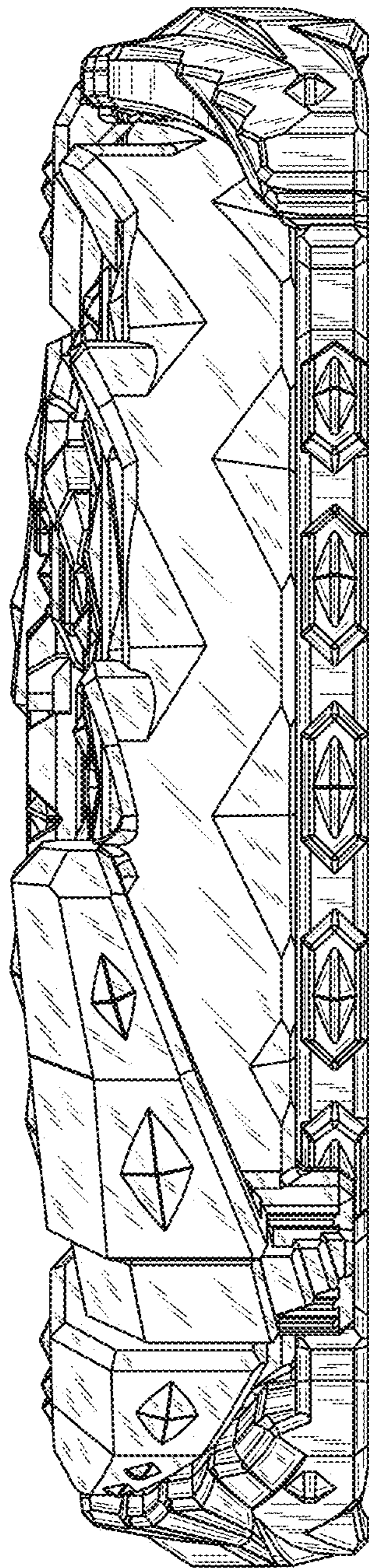

FIG. 41

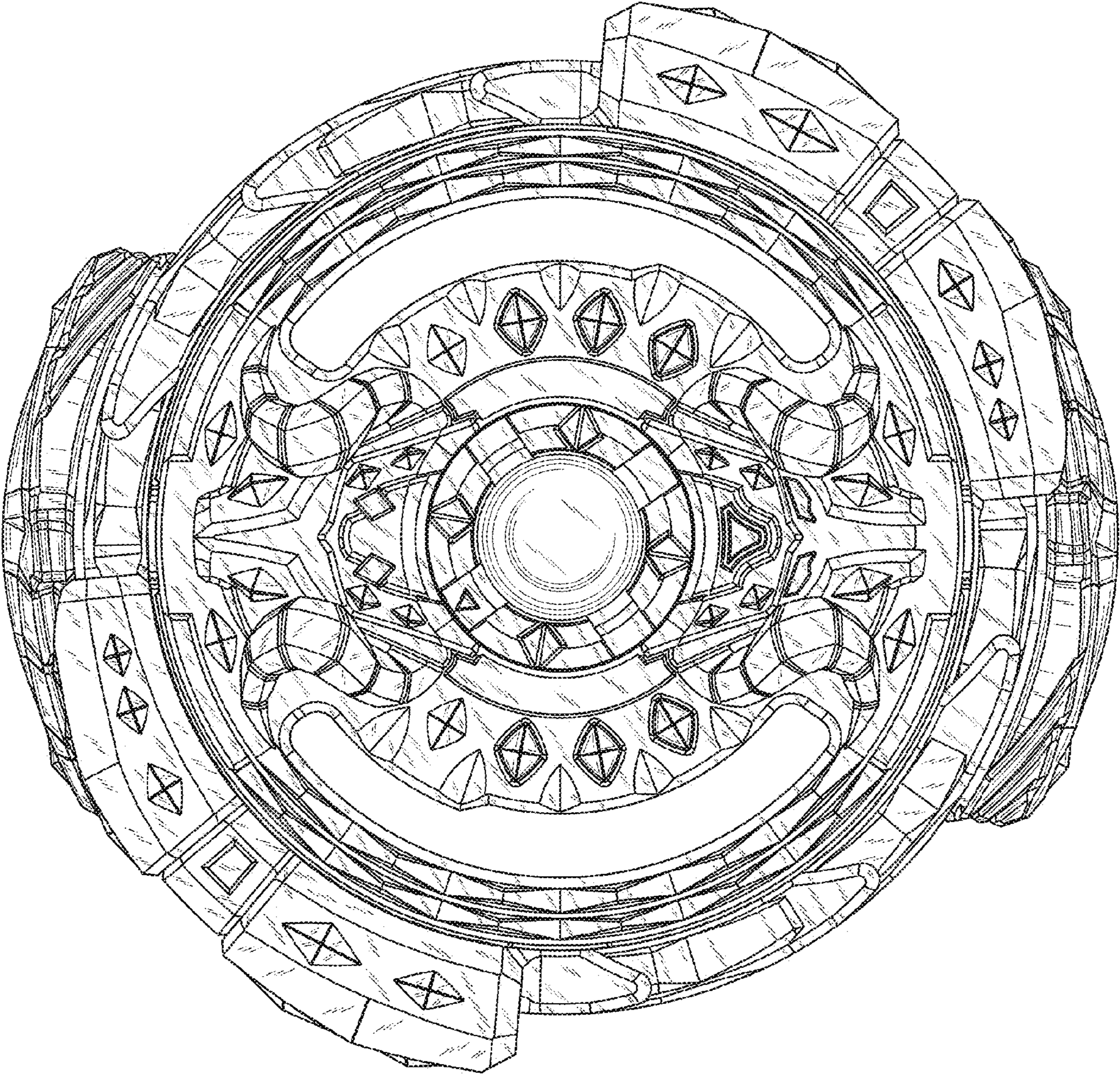

FIG. 42