



US00D880598S

(12) **United States Design Patent** Engler (10) **Patent No.:** **US D880,598 S**
(45) **Date of Patent:** **** Apr. 7, 2020**

(54) **TABLE GAME**
(71) Applicant: **P&P Imports LLC**, Santa Ana, CA (US)
(72) Inventor: **Peter Engler**, Santa Ana, CA (US)
(73) Assignee: **P & P Imports LLC**, Irvine, CA (US)
(**) Term: **15 Years**
(21) Appl. No.: **29/679,930**
(22) Filed: **Feb. 12, 2019**
(51) **LOC (12) Cl.** **21-01**
(52) **U.S. Cl.**
USPC **D21/318**
(58) **Field of Classification Search**
USPC D21/300–307, 315, 318, 319, 331, 334,
D21/335, 342, 349, 386, 350, 355, 390,
D21/397, 655, 699, 705, 731, 771, 780,
D21/789, 790, 791, 804, 805; D6/668.1;
D7/550.1, 551.1, 553.2, 554.3; 473/164,
473/172, 197, 436, 569, 578
CPC A63F 7/0668; A63F 7/0005; A63F 7/3603
See application file for complete search history.

(56) **References Cited**
U.S. PATENT DOCUMENTS
1,634,016 A * 6/1927 Brown A63F 7/0668
273/108.5
4,076,242 A * 2/1978 Joseph A63F 7/0684
273/108.51
4,300,766 A * 11/1981 Haynes A63F 7/3603
273/108.1
5,029,861 A * 7/1991 Driska A63F 7/3065
273/108.53
5,074,556 A * 12/1991 Loeppky A63F 7/0668
273/108.5
D347,026 S * 5/1994 Young D21/318
D400,951 S * 11/1998 Nally D21/397
D423,839 S * 5/2000 Reinmuth D6/707.13
D425,136 S * 5/2000 Martin, Sr. D21/318

D446,250 S * 8/2001 Quiroga D21/318
6,345,820 B1 * 2/2002 Zucchi A63F 7/3603
273/108.5
D500,530 S * 1/2005 Zucchi D21/318
6,840,516 B1 * 1/2005 Tien A63F 7/0005
273/126 A

(Continued)

OTHER PUBLICATIONS

“Gosports Hockey Ice Pucky”, posted Jan. 7, 2019[online], [retrieved Aug. 29, 2019]. Retrieved from internet, https://www.amazon.com/GoSports-Hockey-Pucky-Wooden-Adults/product-reviews/B07H5ZX6Y7/ref=cm_cr_ar_p_d_viewopt_srt?ie=UTF8&reviewerType=all_reviews&sortBy=recent&pageNumber=1.*

(Continued)

Primary Examiner — Kevin K Rudzinski
Assistant Examiner — Mehri F Bajoul
(74) *Attorney, Agent, or Firm* — Casey Kempner

(57) **CLAIM**

The ornamental design for a table game, as shown and described.

DESCRIPTION

FIG. 1 is a perspective view of a table game showing the claimed design.
FIG. 2 is a top view of the table game shown in FIG. 1.
FIG. 3 is a bottom view of the table game shown in FIG. 1.
FIG. 4 is a left-side view of the table game shown in FIG. 1.
FIG. 5 is a right-side view of the table game shown in FIG. 1.
FIG. 6 is a bottom-side view of the table game shown in FIG. 1; and,
FIG. 7 is a top-side view of the table game shown in FIG. 1.
The dashed lines in the figures show portions of the table game that form no part of the claimed design.

1 Claim, 7 Drawing Sheets

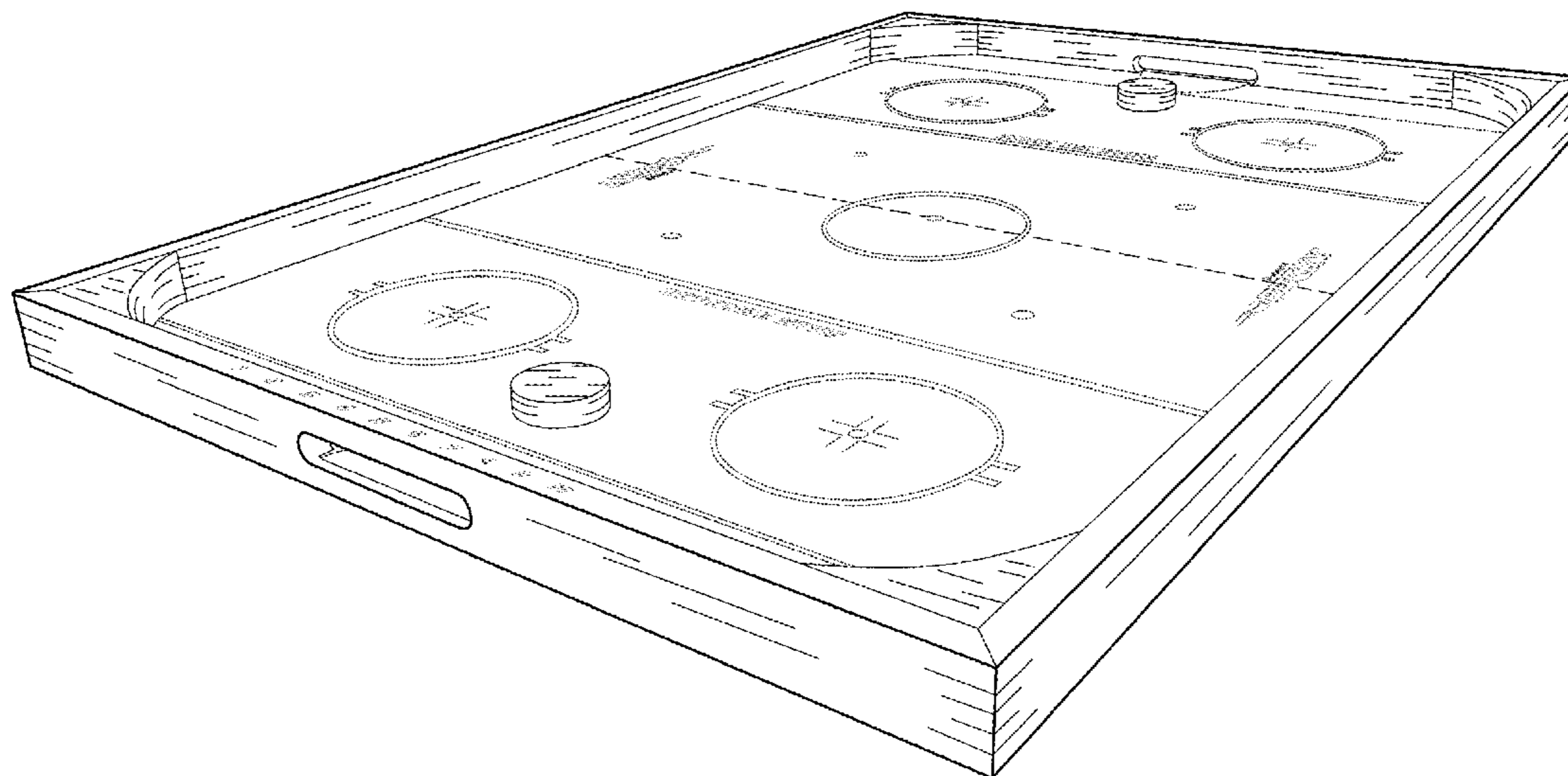

(56)

References Cited

U.S. PATENT DOCUMENTS

7,108,262	B2 *	9/2006	Giegerich	A63B 67/04 273/108
7,178,803	B2 *	2/2007	Nally	A63B 67/14 273/108
7,204,487	B1 *	4/2007	Pohl	A63F 7/06 273/108.1
D556,834	S *	12/2007	Coleman	D21/318
7,357,392	B1 *	4/2008	Wu	A63F 7/3603 273/126 A
7,900,921	B1 *	3/2011	Palmer	A63F 7/0664 273/108
D767,026	S *	9/2016	Foxcroft	D19/113
2002/0096826	A1 *	7/2002	Bisbee	A63F 7/06 273/108.56
2003/0168801	A1 *	9/2003	Zucchi	A63F 7/06 273/126 R
2004/0164488	A1 *	8/2004	Fitzgerald	A63F 7/06 273/108.1
2005/0133993	A1 *	6/2005	Keith	A63F 7/3603 273/108.1
2005/0167908	A1 *	8/2005	Nally	A63F 7/06 273/108.1

OTHER PUBLICATIONS

“Gosports Hockey Ice Pucky”, posted date unavailable[online], [retrieved Aug. 29, 2019]. Retrieved from internet, <https://www.wayfair.com/furniture/pdp/gosports-ice-pucky-wooden-tabletop-hockey-hbww1045.html>.*

Buffalo Games—Pucket—The Frantic, Fast-Paced, Flying Puck Game, https://www.amazon.com/Pucket-Frantic-Fast-Paced-Flying-Puck/dp/B0732WTLNK/ref=cm_cr_arp_d_product_top?ie=UTF8, Published at least as early as Apr. 25, 2019.

Stiga—Stiga 37 in. NHL Stanley Cup Rod Hockey Table Top Game, <https://www.amazon.com/Stiga-Stanley-Hockey-Table-Game/dp/B07C466B1W>, Published at least as early as Apr. 25, 2019.

* cited by examiner

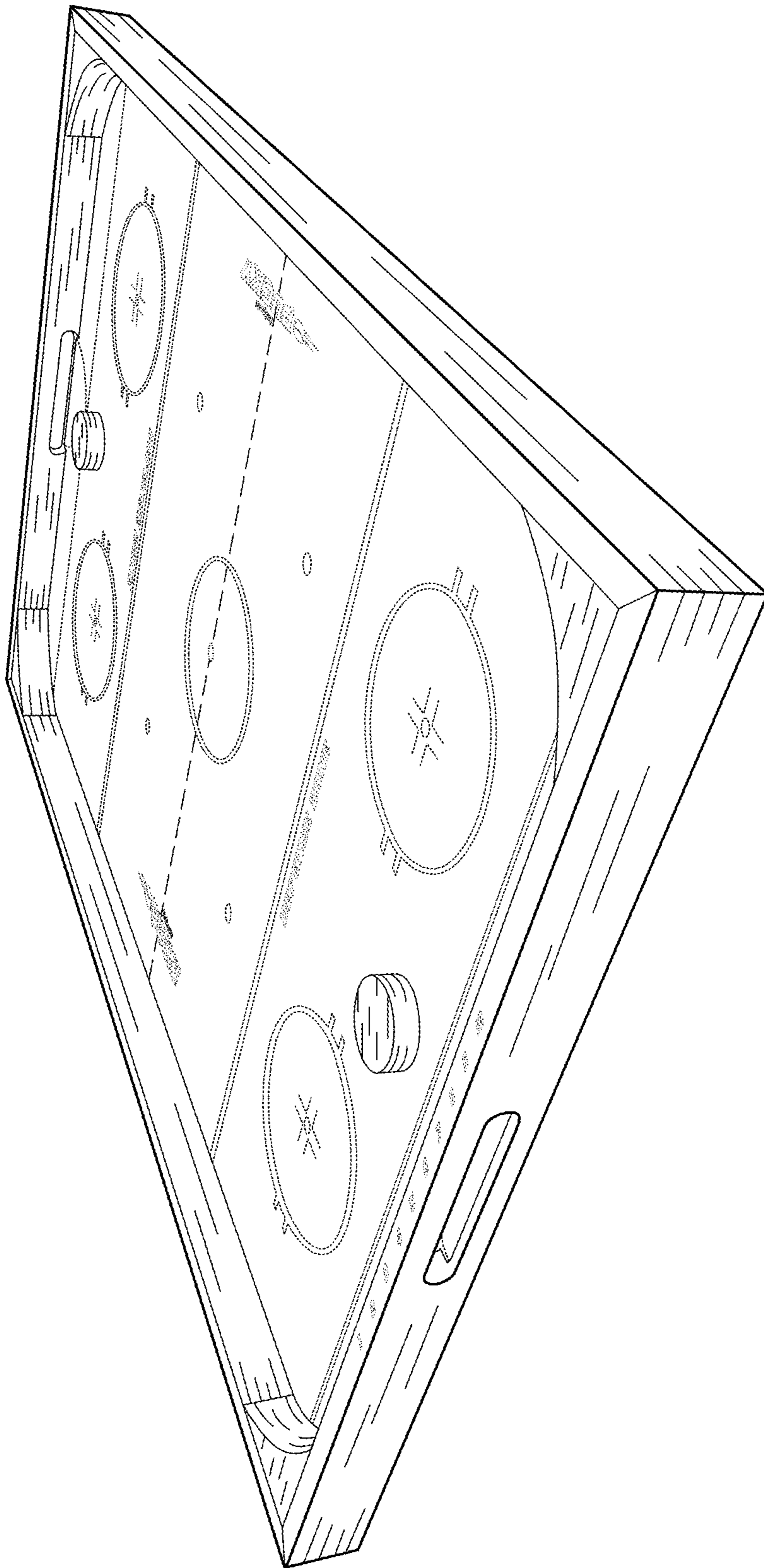

FIG. 1

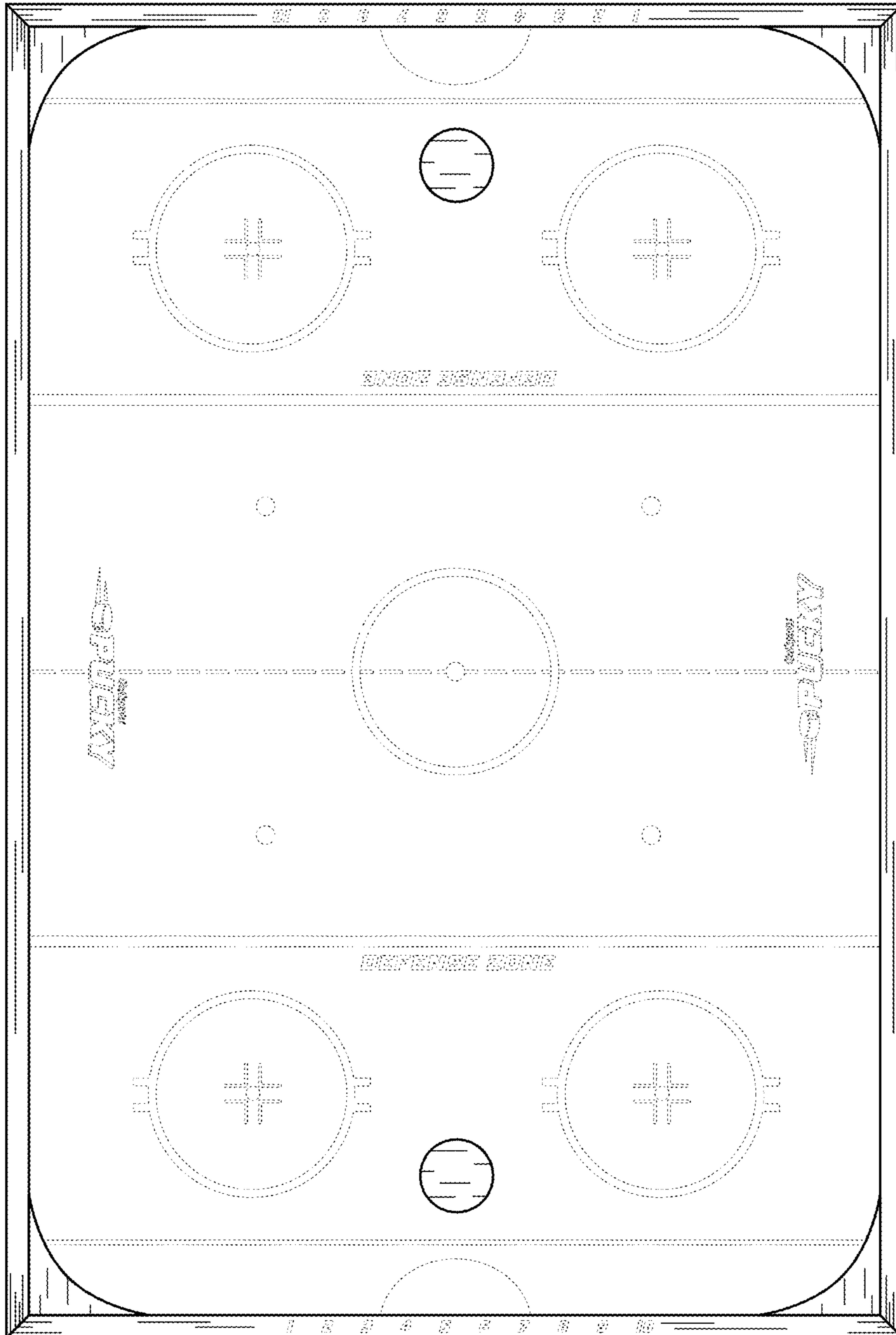

FIG. 2

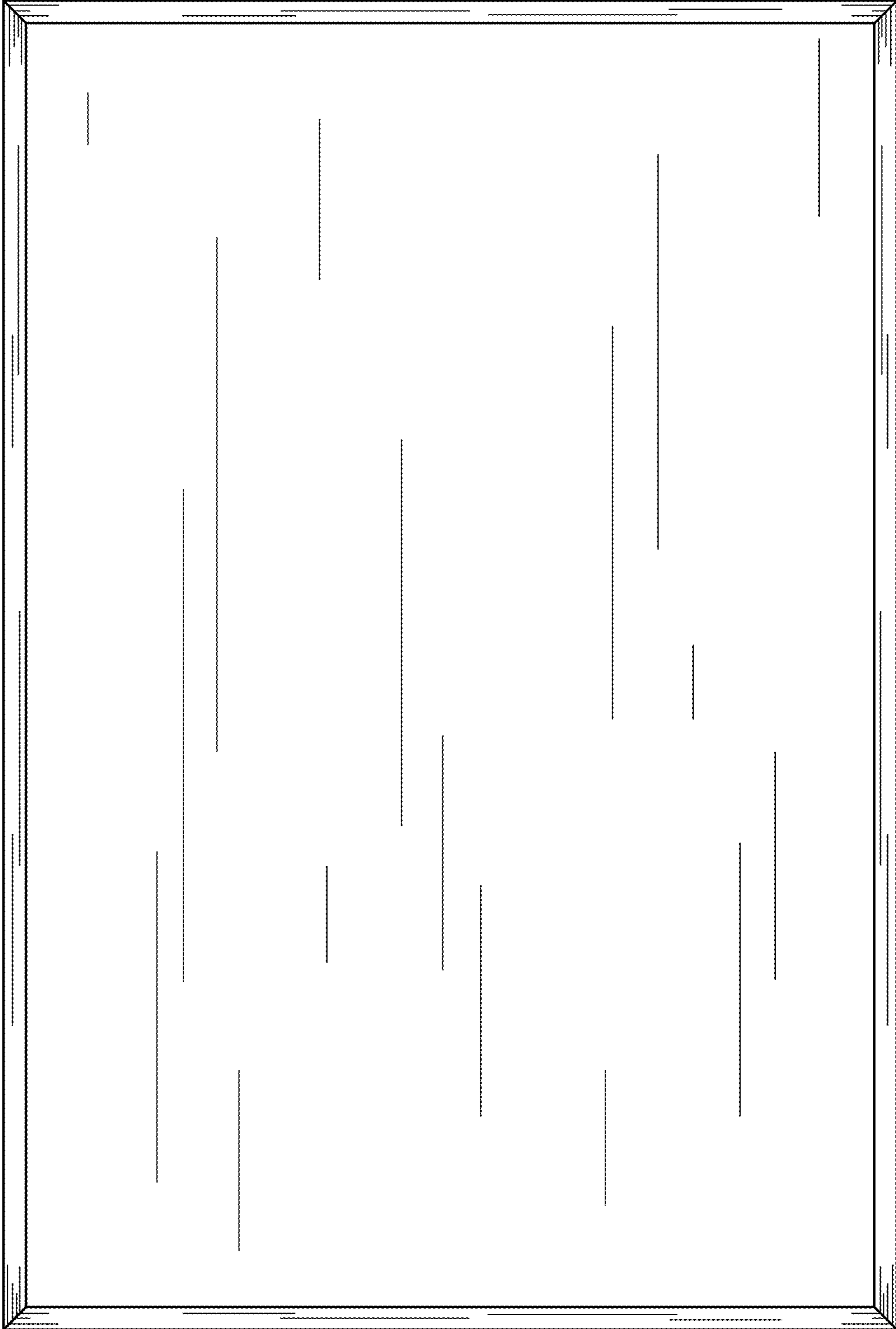

FIG. 3

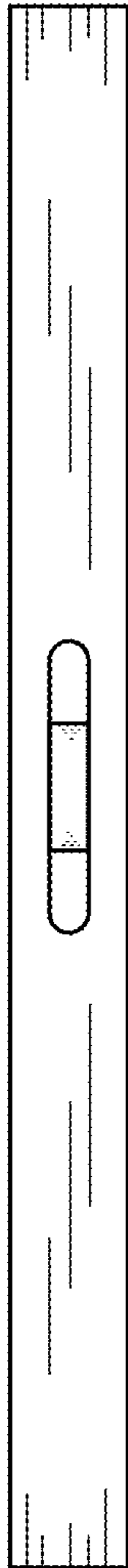

FIG. 4

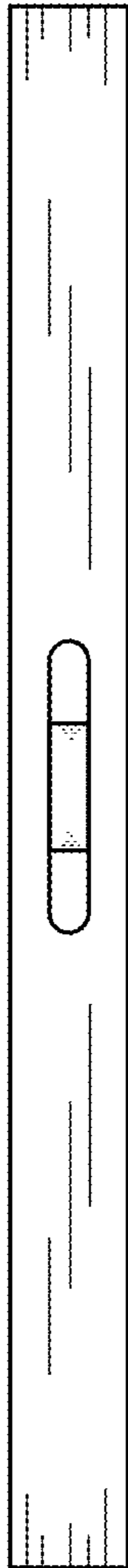

FIG. 5

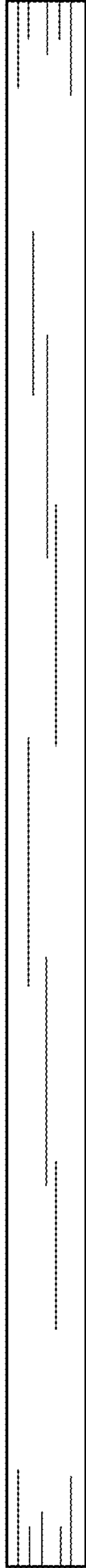

FIG. 6

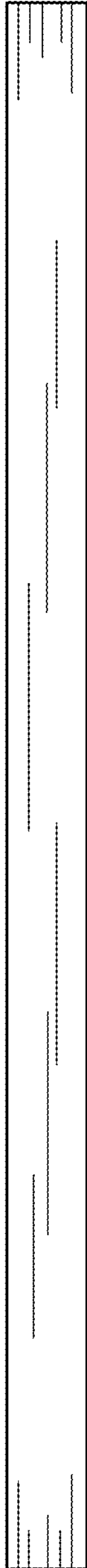

FIG. 7