



US00D880568S

(12) **United States Design Patent** (10) **Patent No.:** **US D880,568 S**  
**Gorsuch et al.** (45) **Date of Patent:** **\*\* Apr. 7, 2020**

(54) **CAMERA MOUNT**

(71) Applicant: **Wisconsin Archery Products LLC**, Mukwonago, WI (US)  
(72) Inventors: **Timothy M. Gorsuch**, Mukwonago, WI (US); **Steven K. Hansen**, Port Washington, WI (US)  
(73) Assignee: **WISCONSIN ARCHERY PRODUCTS LLC**, Mukwonago, WI (US)  
(\*\*) Term: **15 Years**

(21) Appl. No.: **29/585,319**  
(22) Filed: **Nov. 22, 2016**  
(51) **LOC (12) Cl.** ..... **16-05**  
(52) **U.S. Cl.**  
USPC ..... **D16/242**; D25/126; D26/93; D11/130.1; D8/382  
(58) **Field of Classification Search**  
USPC ..... D8/354, 355, 363, 373, 382-383, D8/394-396; D14/224, 229, 238, 251, D14/447, 451, 457; D16/237-250; D11/130.1; D24/128; D26/93  
CPC ..... E04H 12/2215  
See application file for complete search history.

(56) **References Cited**

**U.S. PATENT DOCUMENTS**

584,871 A	6/1897	Gordon	
1,582,381 A	4/1926	Citro	
D140,011 S	1/1945	Creedon	
2,375,214 A	5/1945	Creedon	
D144,840 S	5/1946	Creedon	
2,554,887 A *	5/1951	Tricarico	..... E04H 12/2215 248/545
3,136,519 A	6/1964	Spriggle	
3,185,422 A	5/1965	Spindler	
3,601,598 A	8/1971	Horn	

(Continued)

**OTHER PUBLICATIONS**

Birds Choice Hummingbird Feeder Pole Set, Black, 76-1/2-Inch Birds Choice : Published Jun. 19, 2015 [online], site visited Jul. 30, 2019. Available from Internet URL:https://www.amazon.com/dp/B00MPDS04S/ref=cm\_sw\_r\_tw\_dp\_U\_x\_mdmqDb6NXPJVY (Year: 2015).\*

(Continued)

*Primary Examiner* — Jack Reickel  
*Assistant Examiner* — Melvin L Davis  
(74) *Attorney, Agent, or Firm* — Ryan Kromholz & Manion, S.C.

(57) **CLAIM**

The ornamental design for a camera mount, as shown and described.

**DESCRIPTION**

FIG. 1 is a perspective view of a camera mount of the present invention;  
FIG. 2 is a first side view of the camera mount of the present invention;  
FIG. 3 is a second side view of the camera mount of the present invention;  
FIG. 4 is a third side view of the camera mount of the present invention;  
FIG. 5 is a fourth side view of the camera mount of the present invention;  
FIG. 6 is a top view of the camera mount of the present invention; and,  
FIG. 7 is a bottom view of the camera mount of the present invention.  
The broken lines in the drawings depict environmental structure and form no part of the claimed design. The camera mount is shown with a symbolic break in its length. The appearance of any portion of the article beyond the break line forms no part of the claimed design.

**1 Claim, 2 Drawing Sheets**

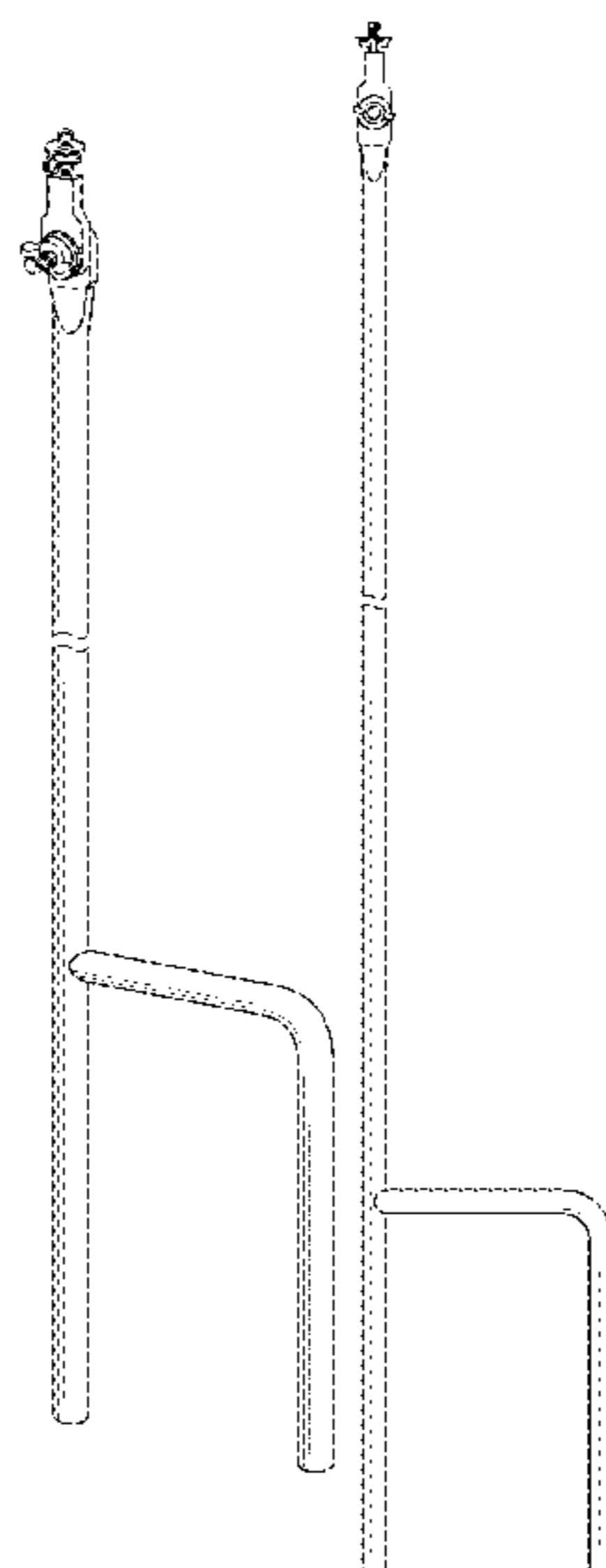

(56)

References Cited

U.S. PATENT DOCUMENTS

3,776,498 A 12/1973 Peters et al.  
 D253,165 S 10/1979 Scott  
 4,290,219 A 9/1981 Boller et al.  
 4,296,725 A 10/1981 Broderick  
 4,470,106 A 9/1984 Norton  
 4,542,873 A 9/1985 Motherly et al.  
 4,617,741 A 10/1986 Bordeaux et al.  
 4,708,221 A 11/1987 Kubiak  
 4,722,501 A 2/1988 Ruhl  
 4,729,363 A 3/1988 Skyba  
 D295,320 S \* 4/1988 Vaughan ..... D24/128  
 4,744,537 A 5/1988 Buckley  
 4,753,528 A 6/1988 Hines et al.  
 D304,608 S \* 11/1989 Filice ..... D21/775  
 4,894,921 A 1/1990 Barlow  
 5,092,552 A 3/1992 Dayton et al.  
 5,263,675 A 11/1993 Roberts et al.  
 5,310,150 A 5/1994 Fecko  
 5,310,151 A 5/1994 Engel  
 D348,215 S 6/1994 Melhorn  
 D356,640 S 3/1995 Nordstrom  
 5,442,861 A 8/1995 Lorocco  
 5,479,712 A 1/1996 Hargrove et al.  
 5,482,241 A 1/1996 Oglesby  
 5,484,253 A 1/1996 Johnson  
 5,518,083 A 5/1996 Blennert  
 5,612,779 A 3/1997 Dunne  
 5,619,981 A 4/1997 Breedlove  
 5,634,278 A 6/1997 London  
 5,652,651 A 7/1997 Dunne  
 5,685,103 A 11/1997 Wiggins  
 D387,884 S \* 12/1997 Mackay ..... D26/93  
 5,692,716 A 12/1997 Himmeisbach  
 5,727,760 A 3/1998 Wytovak et al.  
 5,769,372 A 6/1998 Klosterman  
 5,806,508 A 9/1998 Stempien et al.  
 5,857,651 A 1/1999 Kunevicius  
 5,926,260 A 7/1999 Dunne et al.  
 6,059,240 A 5/2000 Gorsuch  
 6,073,352 A 6/2000 Zykan et al.  
 6,123,311 A \* 9/2000 Trinier ..... E04H 12/2215  
 248/167  
 6,154,971 A 12/2000 Perkins  
 6,191,574 B1 2/2001 Dilaer  
 D452,551 S \* 12/2001 Gonnello ..... D22/147  
 6,397,483 B1 6/2002 Perkins  
 D462,893 S 9/2002 Sung  
 6,445,444 B2 9/2002 Dunne  
 6,478,272 B1 11/2002 McKinsey et al.  
 6,484,888 B2 11/2002 Miller  
 6,526,956 B1 3/2003 Hankins  
 6,663,065 B1 12/2003 Whittenburg  
 6,948,690 B1 9/2005 Sandel  
 6,952,881 B2 10/2005 McGivern  
 7,162,806 B1 1/2007 Swiggart  
 7,296,358 B1 11/2007 Murphy et al.  
 7,313,871 B2 1/2008 Lines et al.  
 7,513,050 B2 4/2009 Kroening, Jr.  
 7,614,156 B1 11/2009 Imig  
 D606,775 S \* 12/2009 Hessler ..... D6/680.3  
 7,832,696 B2 11/2010 Goodman  
 7,861,987 B2 1/2011 Gorsuch et al.  
 8,016,134 B1 9/2011 Templin et al.  
 8,065,807 B2 11/2011 Rucinski  
 8,081,298 B1 12/2011 Cross  
 D652,287 S \* 1/2012 Woller ..... D8/387  
 8,100,044 B1 1/2012 Teetzel et al.  
 8,201,571 B1 6/2012 Smith  
 8,231,095 B2 7/2012 Bean  
 8,316,551 B2 11/2012 Gorsuch et al.  
 8,511,433 B2 8/2013 Place  
 8,561,952 B2 10/2013 Pfeiler  
 8,607,497 B2 12/2013 Green  
 D698,105 S \* 1/2014 Huster ..... D30/199  
 D722,864 S \* 2/2015 Greenthal ..... D8/382

D729,302 S 5/2015 Reese  
 D729,863 S 5/2015 Gorsuch  
 D753,210 S 4/2016 Gorsuch et al.  
 D757,528 S \* 5/2016 Wyss ..... D8/373  
 D757,843 S 5/2016 Gorsuch et al.  
 D762,536 S \* 8/2016 Wurzer ..... D12/174  
 D768,471 S \* 10/2016 Marquez ..... D8/382  
 D785,713 S \* 5/2017 Salome ..... D21/302  
 D809,774 S \* 2/2018 Brady ..... D3/10  
 D813,977 S \* 3/2018 Reese ..... D22/134  
 D818,664 S \* 5/2018 Martinez ..... D34/33  
 D829,479 S \* 10/2018 Pinholster, Jr. .... D6/718.11  
 D854,918 S \* 7/2019 Fitz ..... D8/383  
 2003/0038218 A1 2/2003 Eppard et al.  
 2005/0021282 A1 1/2005 Sarnmut et al.  
 2005/0229468 A1 10/2005 Zaderey et al.  
 2006/0231707 A1 10/2006 Schrot  
 2006/0272194 A1 12/2006 Guettner  
 2007/0068018 A1 3/2007 Gilmore  
 2007/0137088 A1 6/2007 Peters et al.  
 2007/0234626 A1 10/2007 Murdock et al.  
 2007/0277421 A1 12/2007 Perkins et al.  
 2008/0039962 A1 2/2008 McRae  
 2008/0107414 A1 5/2008 Showalter  
 2009/0078500 A1 3/2009 Wydner et al.  
 2009/0205239 A1 8/2009 Smith, III  
 2009/0321186 A1 12/2009 Louchart  
 2010/0200724 A1 \* 8/2010 Kukuk ..... A45B 25/00  
 248/530  
 2011/0296699 A1 12/2011 Maisonneuve et al.  
 2012/0046100 A1 2/2012 Román et al.

OTHER PUBLICATIONS

Ashman Black Shepherd Hook 65 Inch, : Published [date announced] Oct. 10, 2016, site visited Jul. 30, 2019. Available from Internet URL: [https://www.amazon.com/dp/B01GG740LK/ref=cm\\_sw\\_r\\_tw\\_dp\\_U\\_x\\_tonqDbd5KT022](https://www.amazon.com/dp/B01GG740LK/ref=cm_sw_r_tw_dp_U_x_tonqDbd5KT022) (Year: 2016).\*

GrayBunny Shepherd Hook, 35 inch Black, Solid (Non-Hollow) Single Piece : Published Dec. 24, 2015 [online], site visited Jul. 30, 2019[date]. Available from Internet URL [https://www.amazon.com/dp/B014ASR4A6/ref=cm\\_sw\\_r\\_tw\\_dp\\_U\\_x\\_MJnqDb06TXSWG](https://www.amazon.com/dp/B014ASR4A6/ref=cm_sw_r_tw_dp_U_x_MJnqDb06TXSWG) (Year: 2015).\*

Ground Hog(TM): Published 2019 [online], site visited Jul. 30, 2019. Available from Internet URL: <https://www.wiarchery.com/product/ground-hog/> (Year: 2019).\*

Eye Ends (Commercial & MS20668): Published Jul. 25, 2016 [online], site visited Aug. 1, 2019. Available from Internet URL: <https://web.archive.org/web/20160725181235/https://www.lexcocable.com/eye-ends-commercial.html> (Year: 2016).\*

Stealth Cam Cam Stick: Published 2015 [online], site visited Nov. 15, 2019. Available from Internet URL: <https://www.sportsmansguide.com/product/index/stealth-cam-cam-stick> (Year: 2015).\*

Muddy Outdoors Ground Mount: Published Sep. 26, 2016 [online], site visited Nov. 15, 2019. Available from Internet URL: <https://youtu.be/00oCcwF4yjc> (Year: 2016).\*

Slate River LLC Camera Mounts Product List, [www.slateriverllc.com/camera\\_mounts.html](http://www.slateriverllc.com/camera_mounts.html), printed Mar. 5, 2014.

EZ-Aim Game Camera Mount, [www.slateriverllc.myshopify.com](http://www.slateriverllc.myshopify.com), printed Mar. 5, 2014.

EZ-Aim Ratchet Strap Game Camera Mount, [www.slateriverllc.myshopify.com](http://www.slateriverllc.myshopify.com), printed Mar. 5, 2014.

EZ-Aim T Post Game Camera Mount, [www.slateriverllc.myshopify.com](http://www.slateriverllc.myshopify.com), printed Mar. 5, 2014.

EZ-Aim Stick On Adaptor, [www.slateriverllc.myshopify.com](http://www.slateriverllc.myshopify.com), printed Mar. 5, 2014.

Camera Arm with T Handle Mount, [www.slateriverllc.myshopify.com](http://www.slateriverllc.myshopify.com), printed Mar. 5, 2014.

Camera Arm with Bear Claw Mount, [www.slateriverllc.myshopify.com](http://www.slateriverllc.myshopify.com), printed Mar. 5, 2014.

Screw in T Handle Mount, [www.slateriverllc.myshopify.com](http://www.slateriverllc.myshopify.com), printed Mar. 5, 2014.

\* cited by examiner

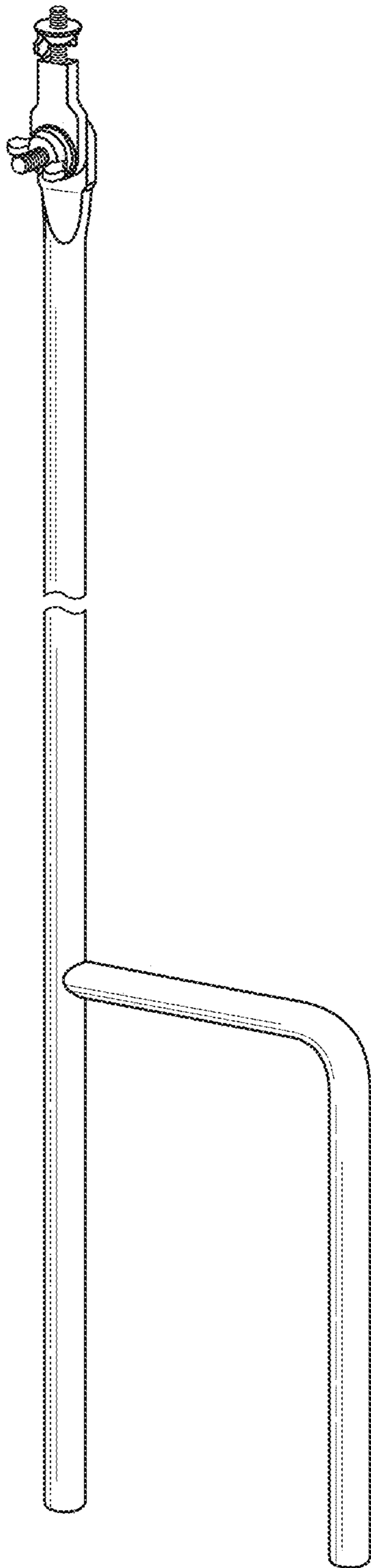

*Fig. 1*

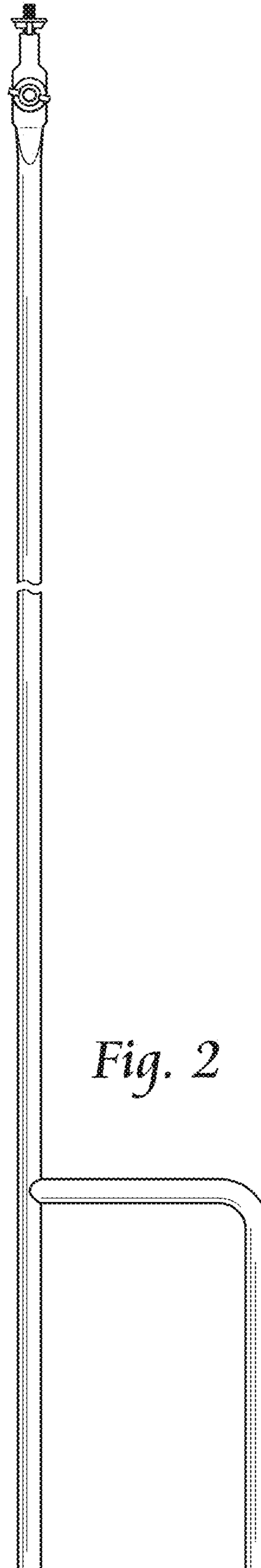

*Fig. 2*

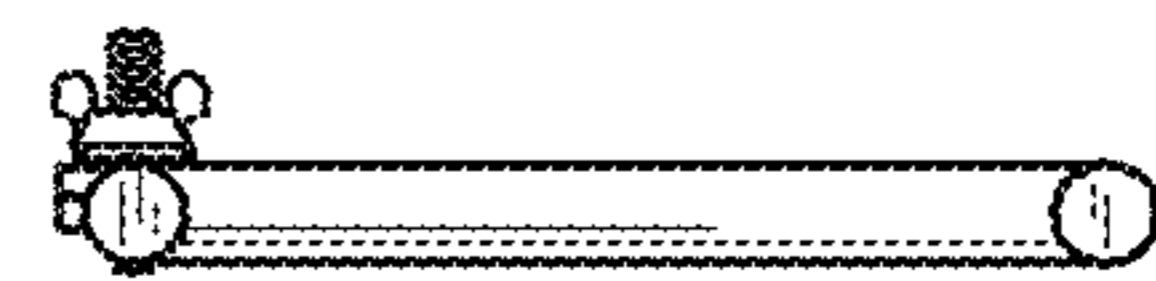
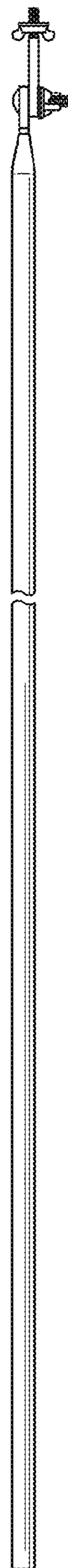
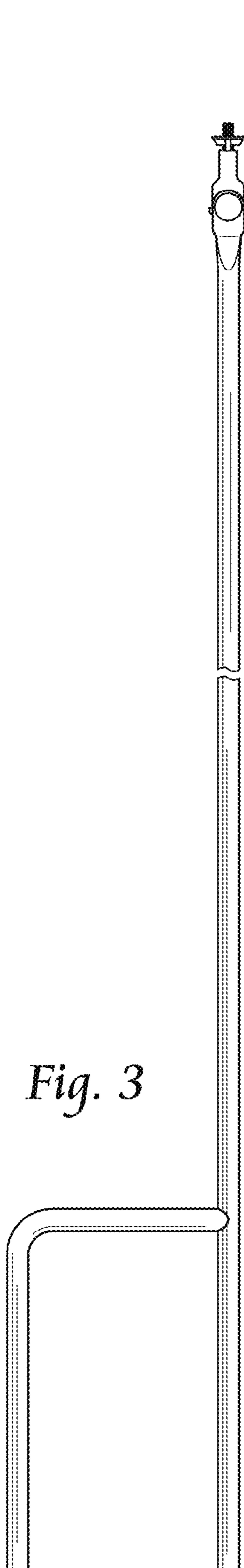

Fig. 4

Fig. 5

Fig. 7

Fig. 6

UNITED STATES PATENT AND TRADEMARK OFFICE  
**CERTIFICATE OF CORRECTION**

PATENT NO. : D880,568 S  
APPLICATION NO. : 29/585319  
DATED : April 7, 2020  
INVENTOR(S) : Timothy M. Gorsuch and Steven K. Hansen

Page 1 of 1

It is certified that error appears in the above-identified patent and that said Letters Patent is hereby corrected as shown below:

On the Title Page

Item (56) References Cited Page 2:

Column 1

“4,542,873 A 9/1985 Motherly et al.” should read --4,542,873 A 9/1985 Matherly et al.--

“5,692,716 A 12/1997 Himmeisbach” should read --5,692,716 A 12/1997 Himmelsbach--

“6,191,574 B1 2/2001 Dilaer” should read --6,191,574 B1 2/2001 Dilger--

Column 2

“2005/0021282 A1 1/2005 Sarnmut et al.” should read --2005/0021282 A1 1/2005 Sammut et al.--

Signed and Sealed this  
Twenty-first Day of September, 2021



Drew Hirshfeld  
*Performing the Functions and Duties of the  
Under Secretary of Commerce for Intellectual Property and  
Director of the United States Patent and Trademark Office*