



US00D880537S

(12) **United States Design Patent** (10) **Patent No.:** **US D880,537 S**
Roach et al. (45) **Date of Patent:** **** Apr. 7, 2020**

(54) **AGRICULTURAL PRODUCT APPLICATOR HOOD**

(71) Applicant: **CNH Industrial America LLC**, New Holland, PA (US)

(72) Inventors: **William A. Roach**, Lake Lillian, MN (US); **Charles D. O'Connell**, Willmar, MN (US); **Eric Jacobsthal**, Elmhurst, IL (US); **Matthew W. Gunlogson**, Benson, MN (US); **Jesse Gonzales**, Falls Church, VA (US); **Russell Alan Meyer**, Crystal Lake, IL (US)

(73) Assignee: **CNH Industrial America LLC**, New Holland, PA (US)

(**) Term: **15 Years**

(21) Appl. No.: **29/622,593**

(22) Filed: **Oct. 18, 2017**

(51) **LOC (12) Cl.** **15-03**

(52) **U.S. Cl.**
USPC **D15/31**

(58) **Field of Classification Search**
USPC D15/10, 14, 15, 22-26, 33; 180/69.2, 180/89.1, 89.12, 900; 56/12.7, 15.8, 16.7, 56/13.3, 10.1, 202, 320.1
CPC A01B 51/026; B62D 49/02; B62D 33/06; B62D 33/0604; B62D 33/0617; B62D 25/10; B60K 15/063; B60K 15/073; B60K 2015/0637
See application file for complete search history.

(56) **References Cited**

U.S. PATENT DOCUMENTS

D521,532 S * 5/2006 Higashikawa D15/31
D533,882 S * 12/2006 Higashikawa D15/31
D591,777 S * 5/2009 Kokitkar D15/31

D620,503 S * 7/2010 Krogh D15/31
D620,955 S * 8/2010 Krogh D15/31
D631,489 S * 1/2011 Booth D15/31
D632,312 S * 2/2011 Booth D15/31
D646,305 S * 10/2011 Krogh D15/31
D655,317 S * 3/2012 Hagele D15/31
D655,318 S * 3/2012 Hagele D15/31
D661,323 S * 6/2012 Krogh D15/31
D668,695 S * 10/2012 Ringer D15/31
D675,233 S * 1/2013 Kushita D15/31
D676,466 S * 2/2013 Ewringmann D15/20
D706,841 S * 6/2014 Shimomura D15/31
D707,729 S * 6/2014 Jackson D15/31
D707,730 S * 6/2014 Jackson D15/31
D714,838 S * 10/2014 Shimomura D15/31
D716,348 S * 10/2014 Ryan D15/31
D716,846 S * 11/2014 Carter D15/31
D733,767 S * 7/2015 Kushita D15/31
D753,194 S * 4/2016 Jackson D15/31

(Continued)

Primary Examiner — Mark A Goodwin

(74) *Attorney, Agent, or Firm* — Rebecca L. Henkel; Rickard K. DeMille

(57) **CLAIM**

The ornamental design for an agricultural product applicator hood, as shown and described.

DESCRIPTION

FIG. 1 is an isometric view of an agricultural product applicator hood in accordance with the present invention; FIG. 2 is a front elevation view of FIG. 1; FIG. 3 rear elevation view of FIG. 1; FIG. 4 is first side elevation view of FIG. 1; FIG. 5 is a second side elevation view of FIG. 1; FIG. 6 is a top plan view of FIG. 1; and, FIG. 7 is a bottom plan elevation view of FIG. 1. The broken line showing of various surface features is included for the purpose of illustrating portions of the agricultural product applicator hood and forms no part of the claimed design.

1 Claim, 6 Drawing Sheets

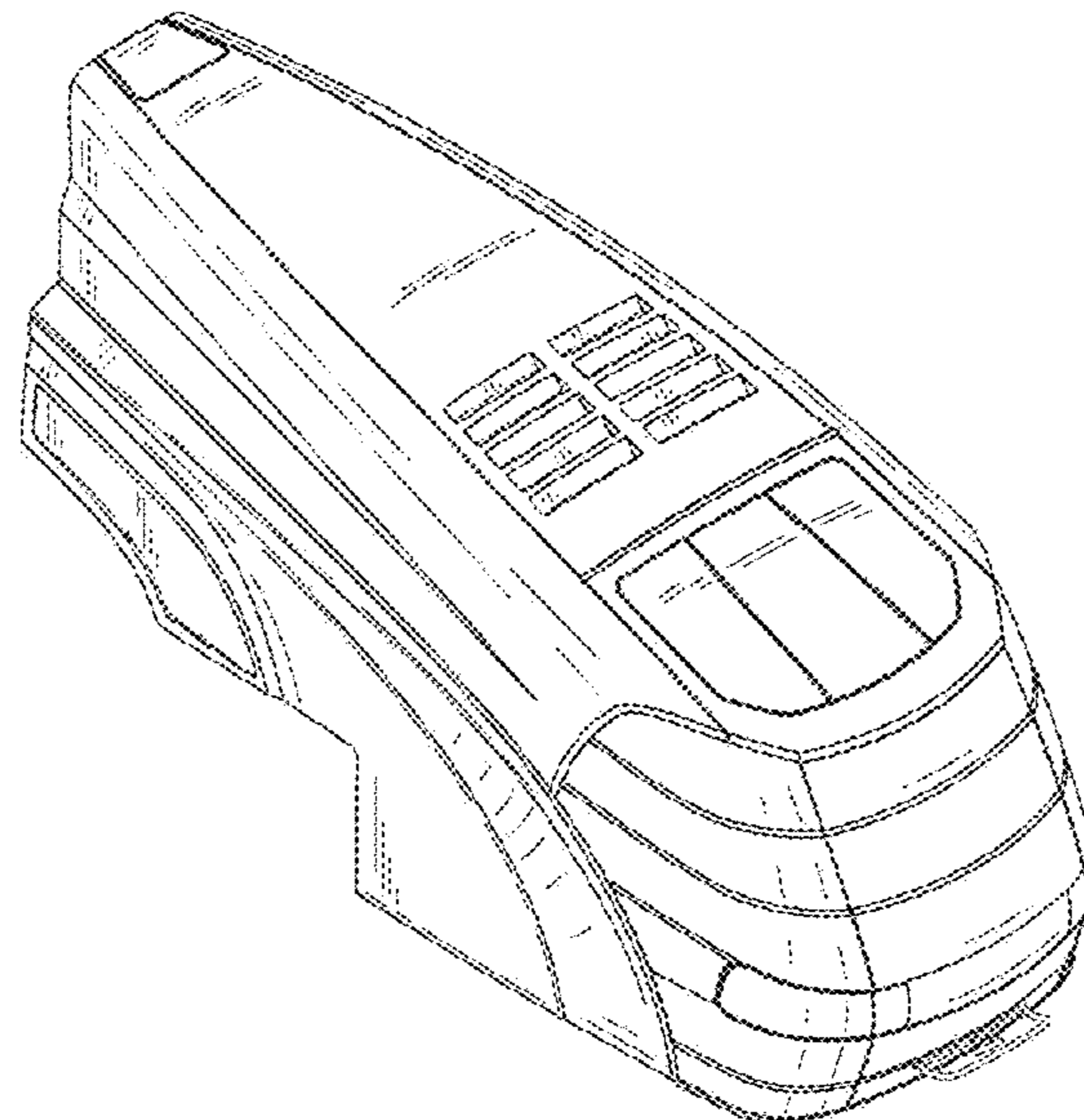

(56)

References Cited

U.S. PATENT DOCUMENTS

| | | | | | | |
|----------|---|---|---------|------------|-------|--------|
| D765,740 | S | * | 9/2016 | Jackson | | D15/31 |
| D766,340 | S | * | 9/2016 | Jackson | | D15/31 |
| D766,341 | S | * | 9/2016 | Jacobsthal | | D15/31 |
| D768,210 | S | * | 10/2016 | Jacobsthal | | D15/31 |
| D777,219 | S | * | 1/2017 | Hanke | | D15/31 |
| D777,220 | S | * | 1/2017 | Powell | | D15/31 |
| D778,963 | S | * | 2/2017 | Yang | | D15/31 |
| D785,681 | S | * | 5/2017 | Okuyama | | D15/31 |
| D804,539 | S | * | 12/2017 | Okuyama | | D15/31 |

* cited by examiner

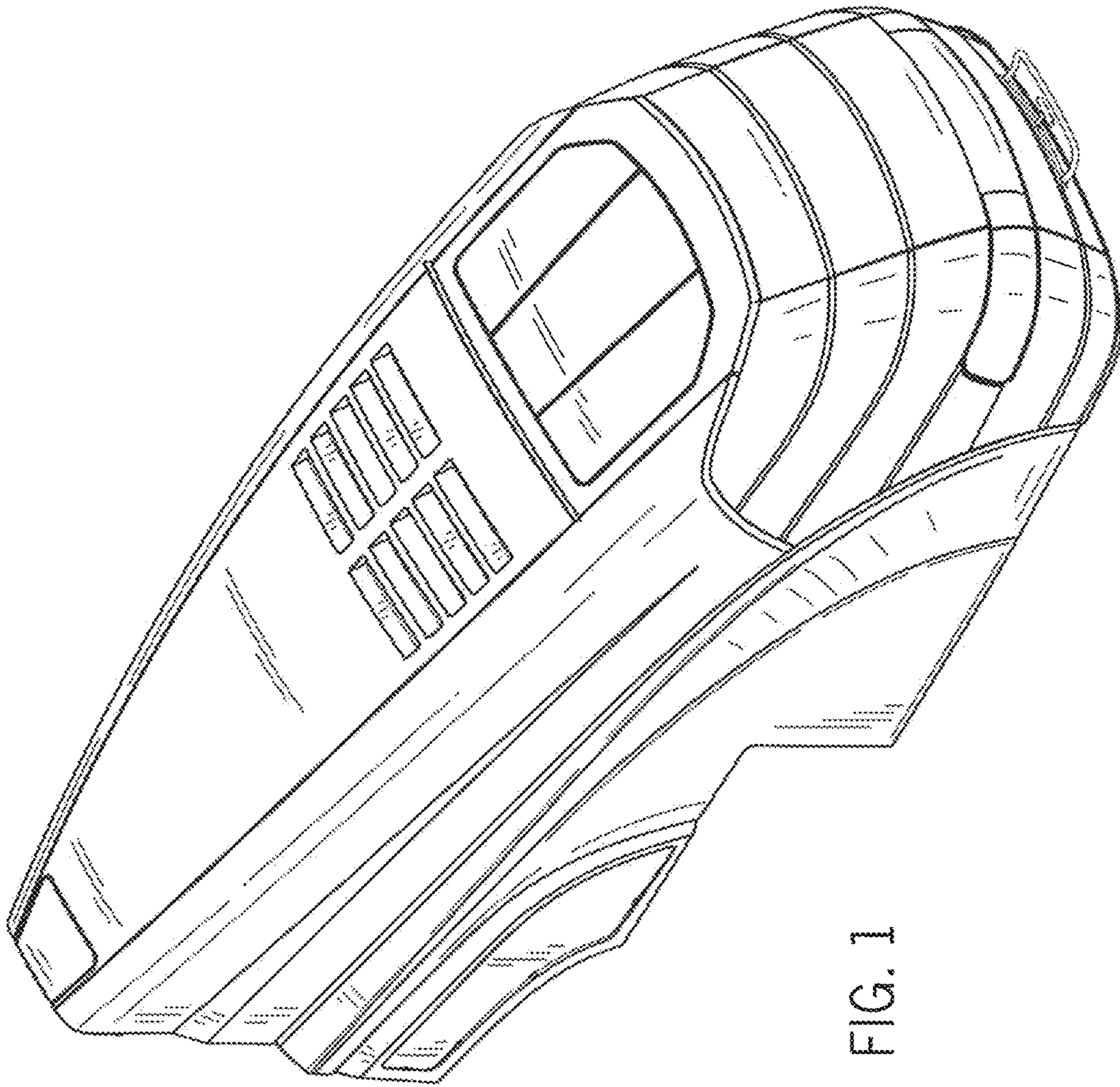

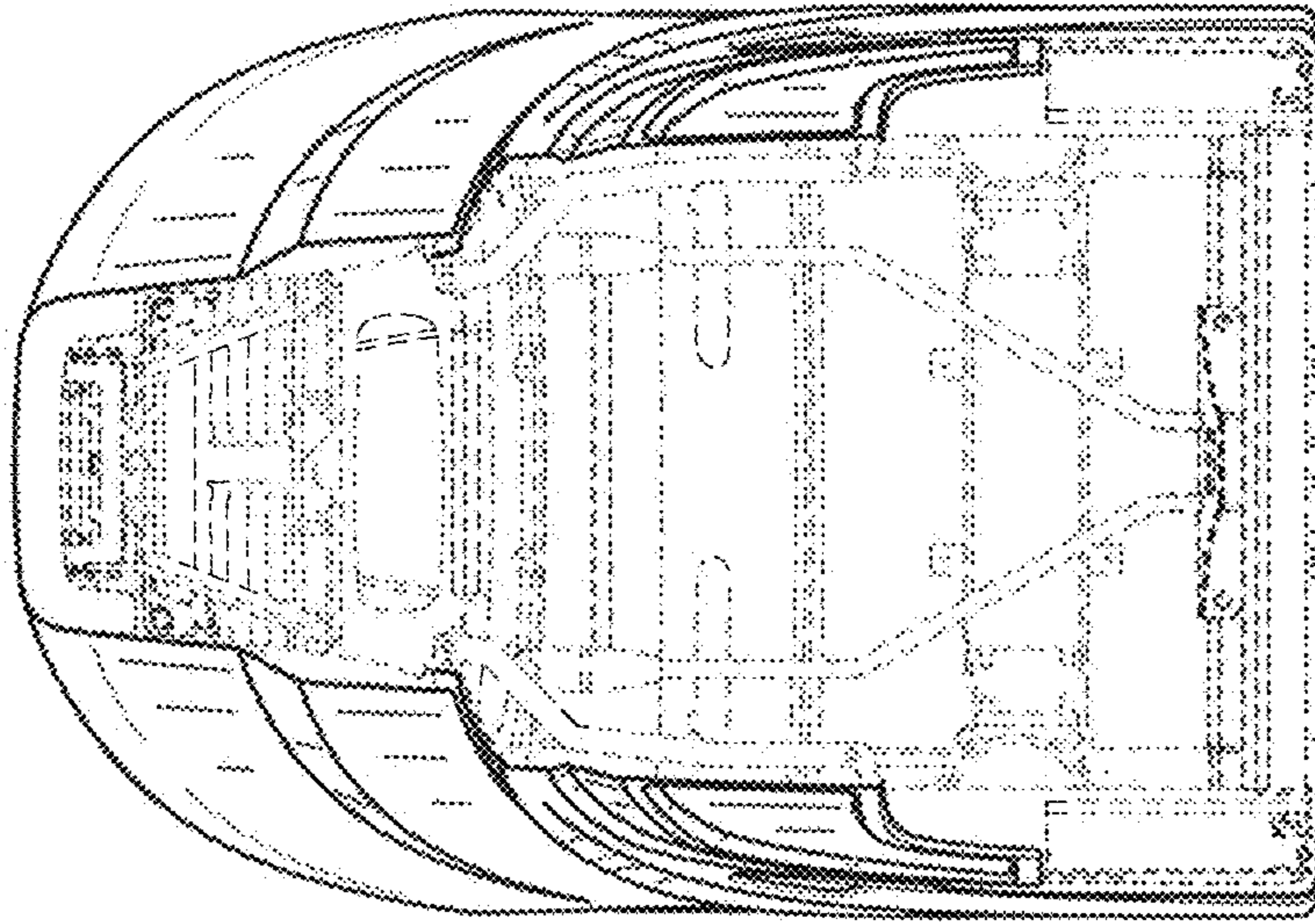

FIG. 2

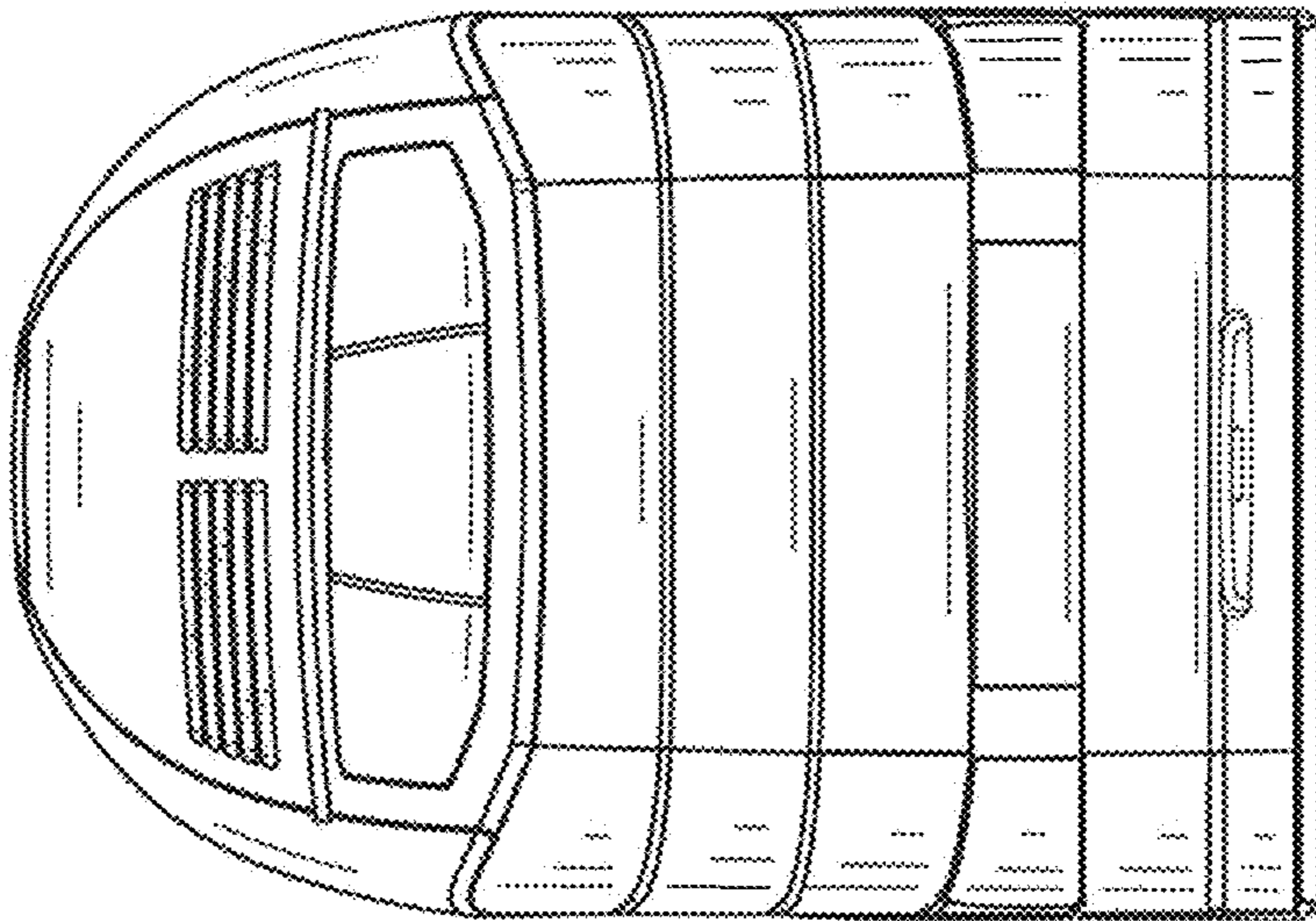

FIG. 3

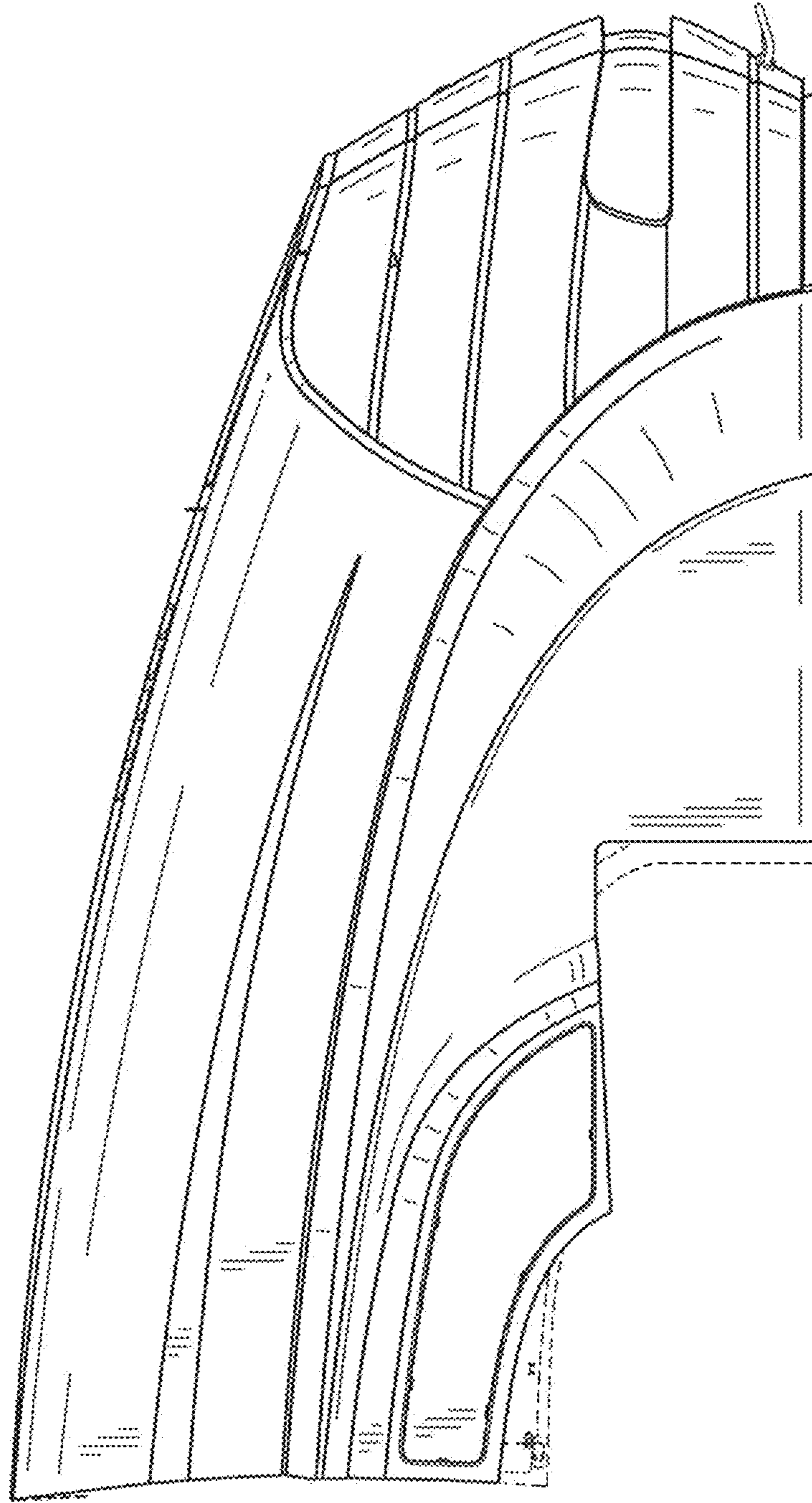

FIG. 4

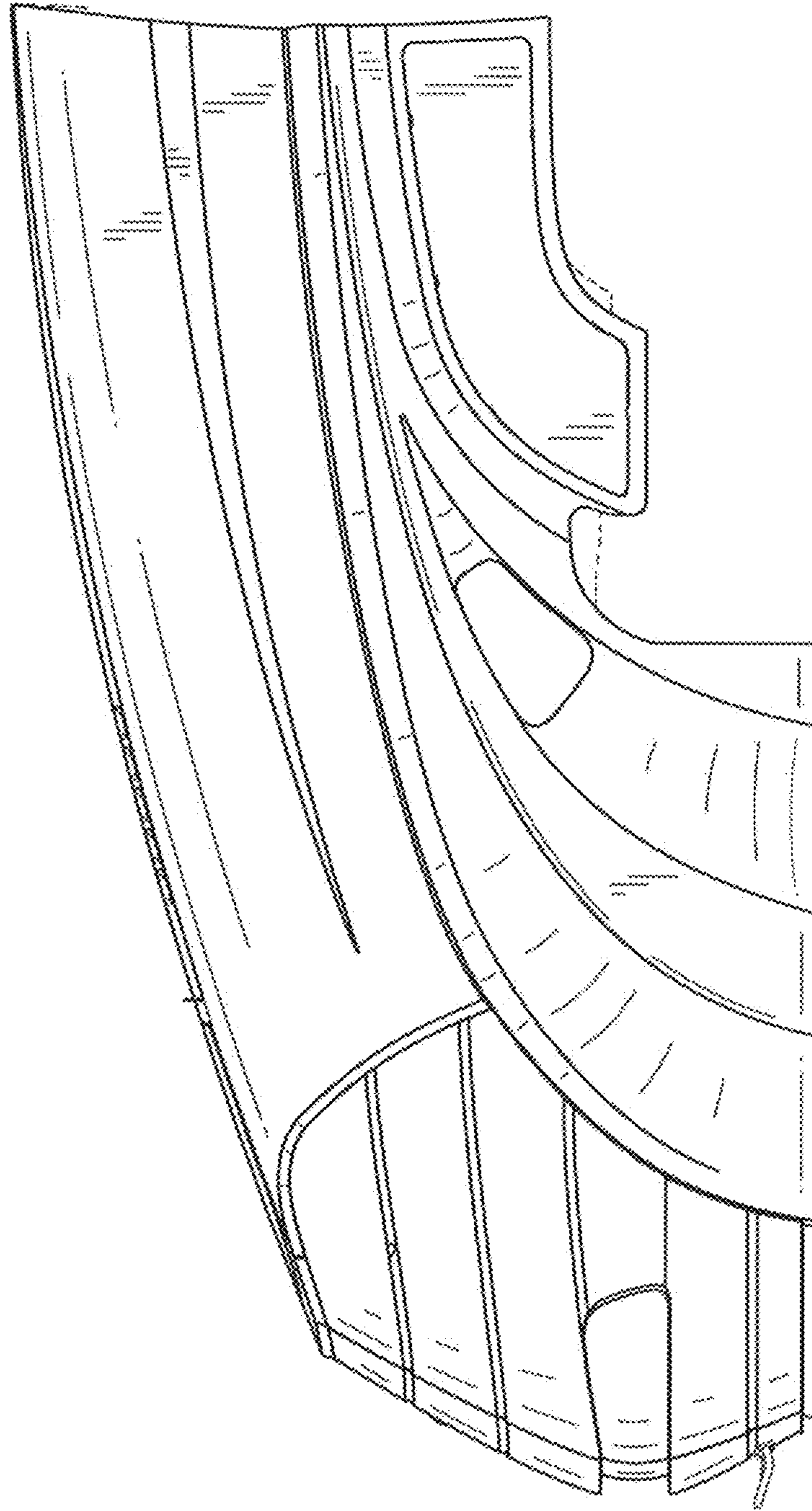

FIG. 5

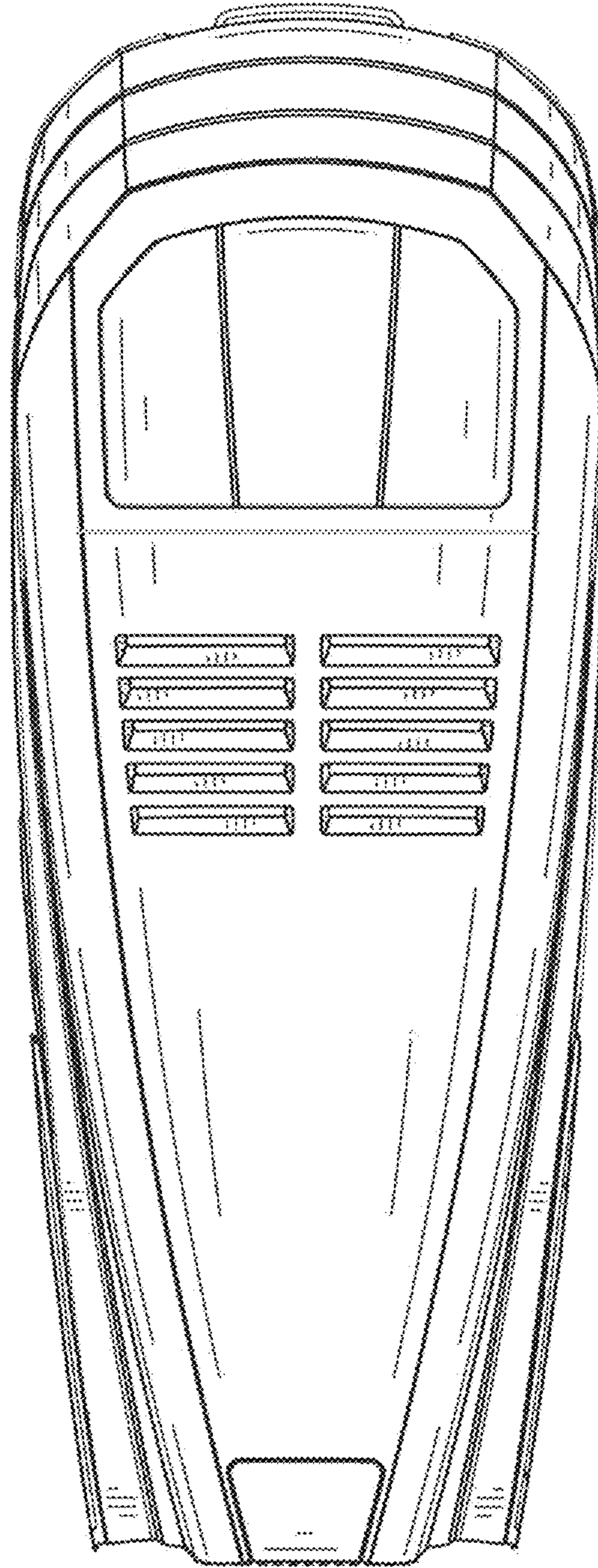

FIG. 6

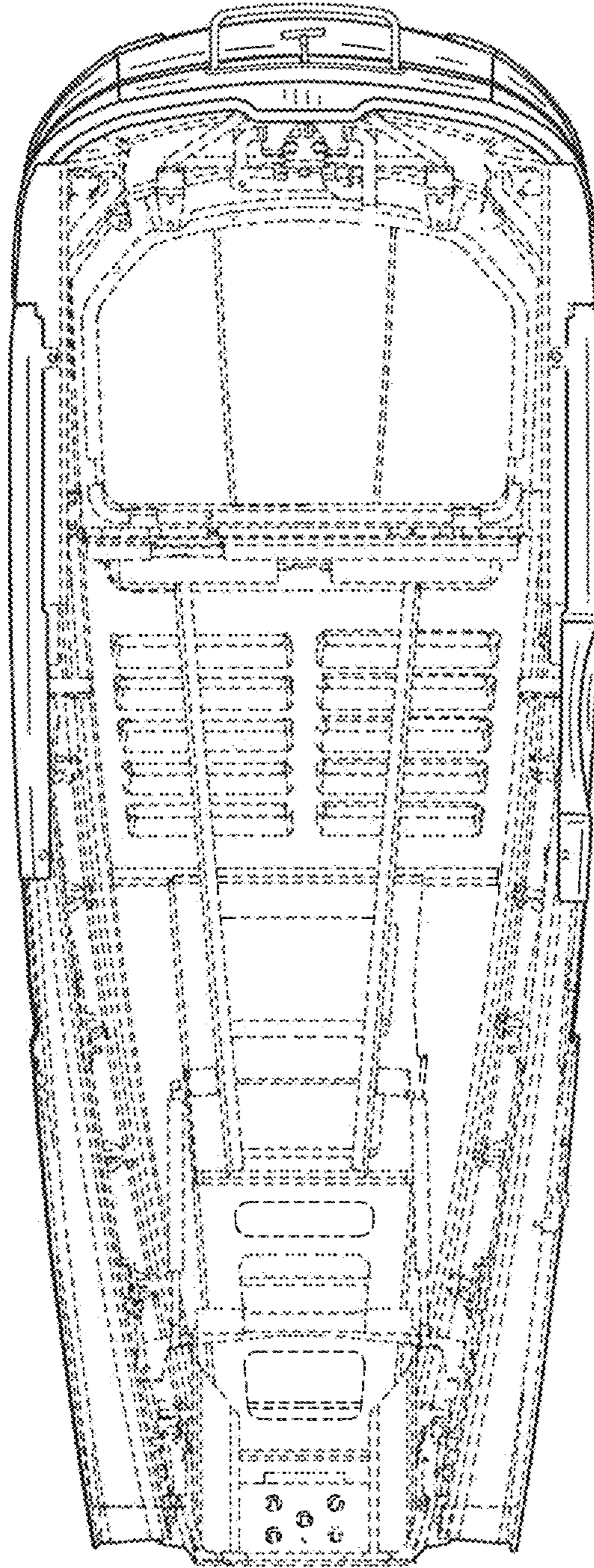

FIG. 7