



US00D880466S

(12) **United States Design Patent**
Hyll

(10) **Patent No.:** **US D880,466 S**

(45) **Date of Patent:** **** Apr. 7, 2020**

(54) **MOBILE TELEPHONE CASE**

(71) Applicant: **Victor Hyll**, Svedala (SE)

(72) Inventor: **Victor Hyll**, Svedala (SE)

(**) Term: **15 Years**

(21) Appl. No.: **29/610,242**

(22) Filed: **Jul. 11, 2017**

(30) **Foreign Application Priority Data**

Feb. 2, 2017 (EM) 003735745

(51) **LOC (12) Cl.** **14-03**

(52) **U.S. Cl.**
USPC **D14/250**

(58) **Field of Classification Search**

USPC D14/250, 203.3-203.7, 439, 238.1, 440,
D14/251-253, 447, 217, 240, 248, 433;
D3/201, 218, 247, 269, 273, 301, 303;
D13/103, 107-108, 119

CPC H04B 1/3888; H04M 1/0283; H04M
1/0202; A45C 1/06; A45C 11/00; A45C
13/02; A45C 2011/002; A45F 2005/026;
A45F 2200/0525; A45F 2200/0516

See application file for complete search history.

(56) **References Cited**

U.S. PATENT DOCUMENTS

5,400,903 A * 3/1995 Cooley A45C 13/02
190/29
D378,171 S * 2/1997 Liu D6/336
5,717,566 A * 2/1998 Tao G06F 1/1603
348/834
5,905,546 A * 5/1999 Giulie G06F 1/1603
348/842
6,046,754 A * 4/2000 Stanek G06F 1/1603
345/169
7,197,140 B2 * 3/2007 Asaro H04M 1/19
379/433.03

7,508,657 B1 * 3/2009 Smith G06F 1/1601
361/679.24
7,553,034 B1 * 6/2009 Liou G06F 1/1603
359/601
8,727,546 B2 * 5/2014 Trinh B60K 35/00
359/601
D790,551 S * 6/2017 Hoejlund-Hansen D14/440
D793,377 S * 8/2017 Vinci D14/250
9,742,457 B2 * 8/2017 Tymus H04B 1/3888

(Continued)

Primary Examiner — Carla J Wright

(74) *Attorney, Agent, or Firm* — Babcock IP, PLLC

(57) **CLAIM**

The ornamental design for a mobile telephone case, as shown and described.

DESCRIPTION

FIG. 1 is a perspective front view of a mobile telephone case showing my new design with the visor portion of the case in a retracted position;

FIG. 2 is a perspective back view thereof;

FIG. 3 is a front elevation view thereof;

FIG. 4 is a bottom plan view thereof;

FIG. 5 is a back elevation view thereof;

FIG. 6 is a top plan view thereof; and

FIG. 7 is a right side elevation view thereof.

FIG. 8 is a perspective front view of the mobile telephone case showing my new design with the visor portion of the case in an extended position;

FIG. 9 is a perspective back view thereof;

FIG. 10 is a front elevation view thereof;

FIG. 11 is a bottom plan view thereof;

FIG. 12 is a back elevation view thereof;

FIG. 13 is a top plan view thereof; and,

FIG. 14 is a right side elevation view thereof.

The broken lines in the figures show portions of the mobile telephone case that form no part of the claimed design.

1 Claim, 14 Drawing Sheets

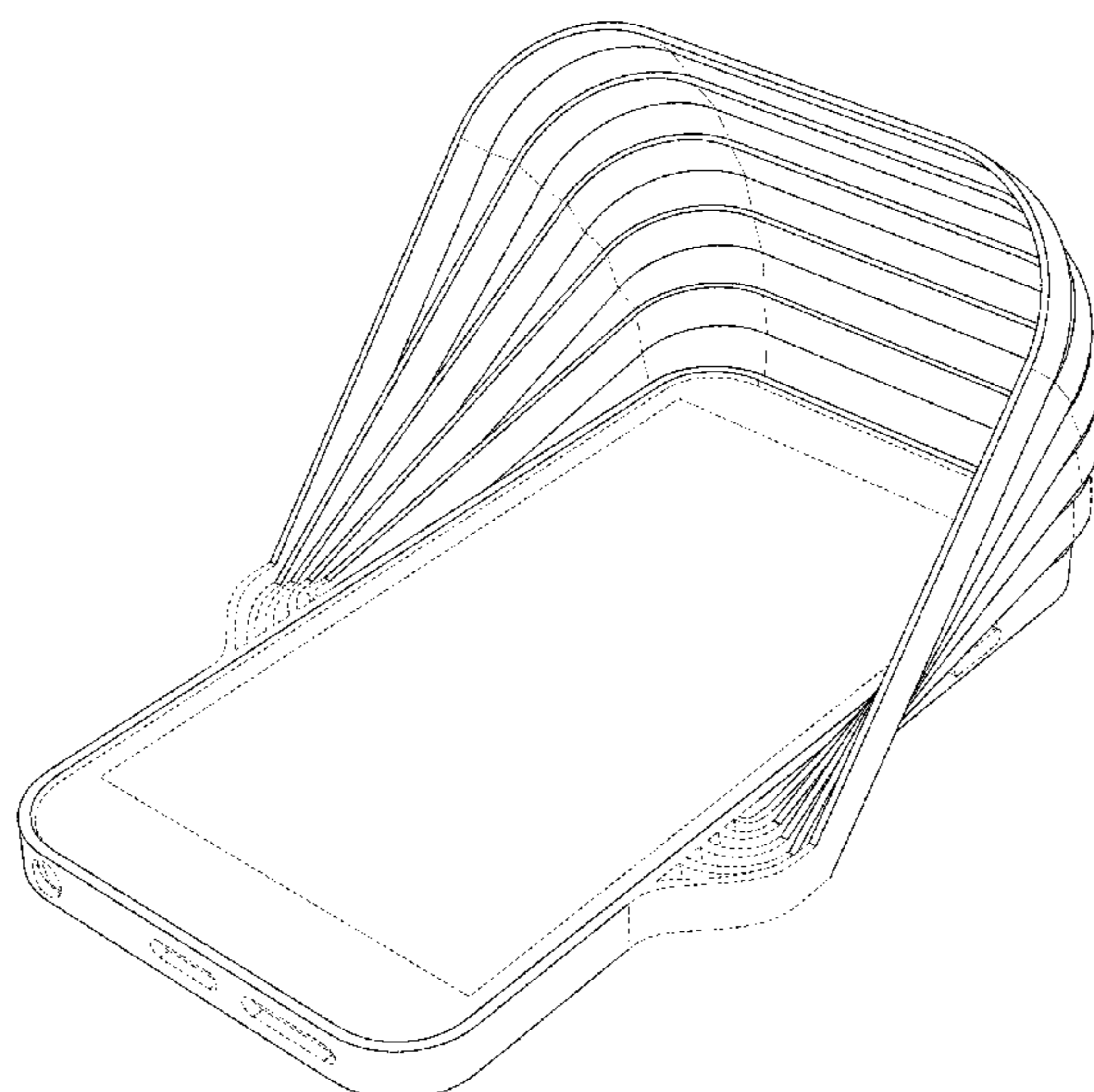

(56)

References Cited

U.S. PATENT DOCUMENTS

9,806,756 B1 * 10/2017 Jacobs H04M 1/185
D807,869 S * 1/2018 Petersen D14/250
D851,697 S * 6/2019 Qiu D18/4.6
2009/0219621 A1 * 9/2009 Perkins, II H05K 5/0239
359/601
2013/0341233 A1 * 12/2013 Dow G06F 1/1603
206/521
2014/0375901 A1 * 12/2014 Stockett H04N 5/64
348/838
2015/0124328 A1 * 5/2015 Dorros G06F 1/1603
359/609
2015/0381785 A1 * 12/2015 Gander A45F 5/00
455/575.1
2016/0032644 A1 * 2/2016 Geller E06B 9/24
160/134
2016/0227663 A1 * 8/2016 Holmes G06F 1/1603
2019/0097669 A1 * 3/2019 Zaccaria H04B 1/3888

* cited by examiner

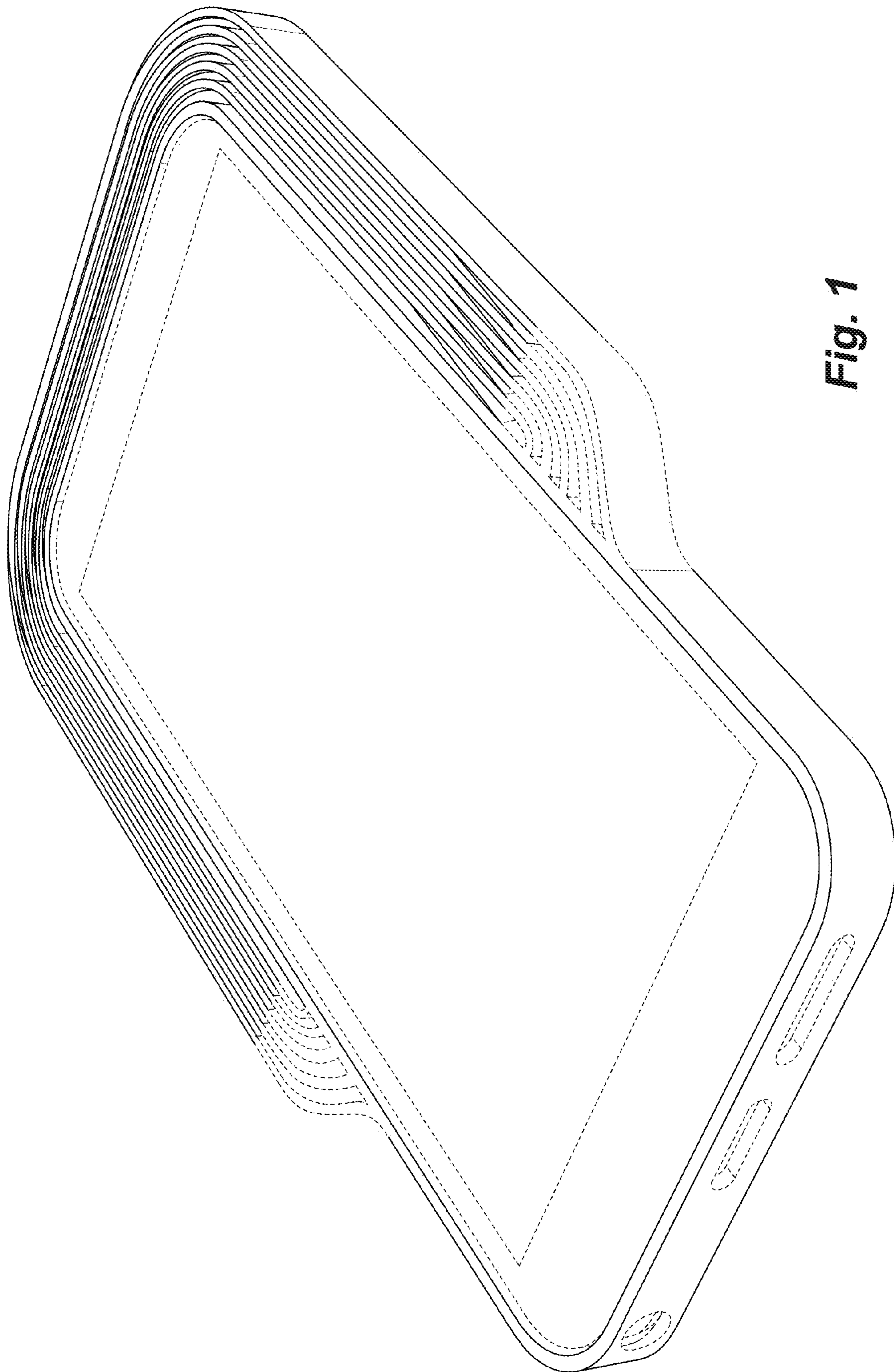

Fig. 1

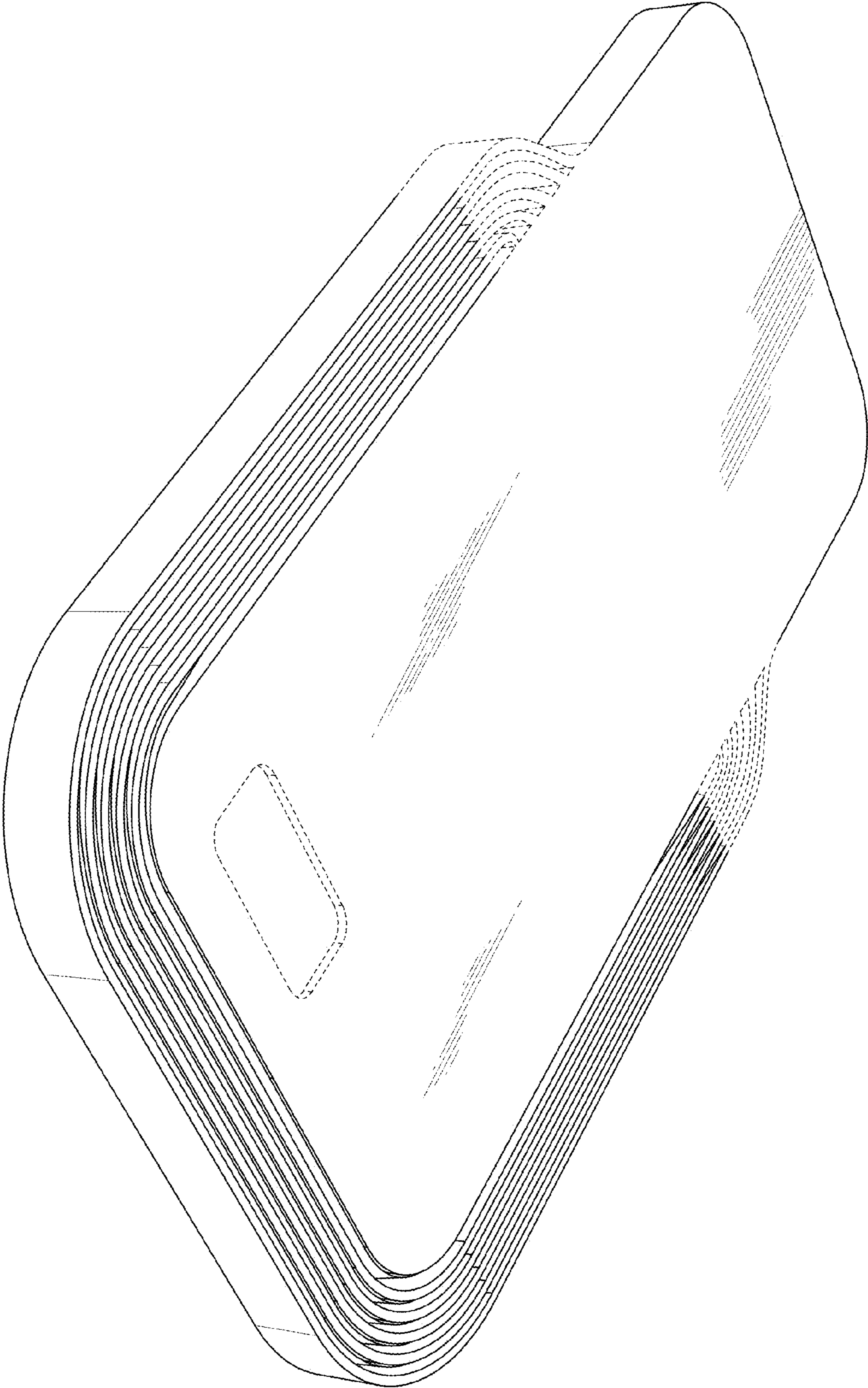

Fig. 2

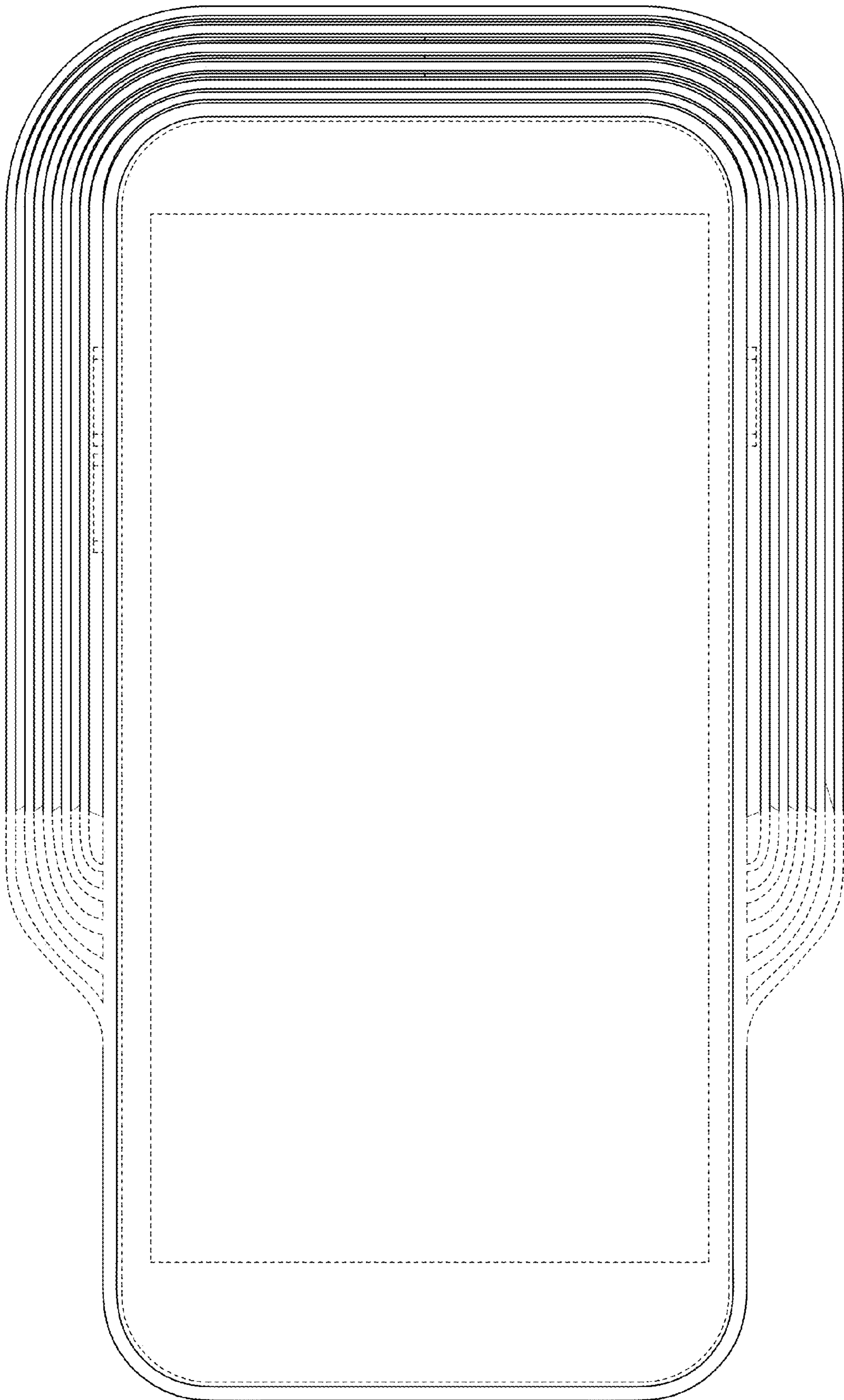

Fig. 3

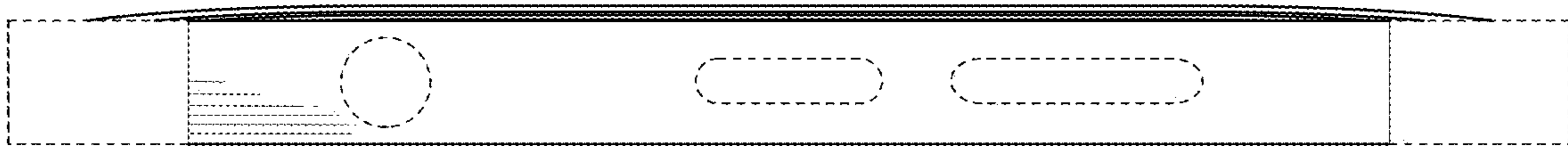

Fig. 4

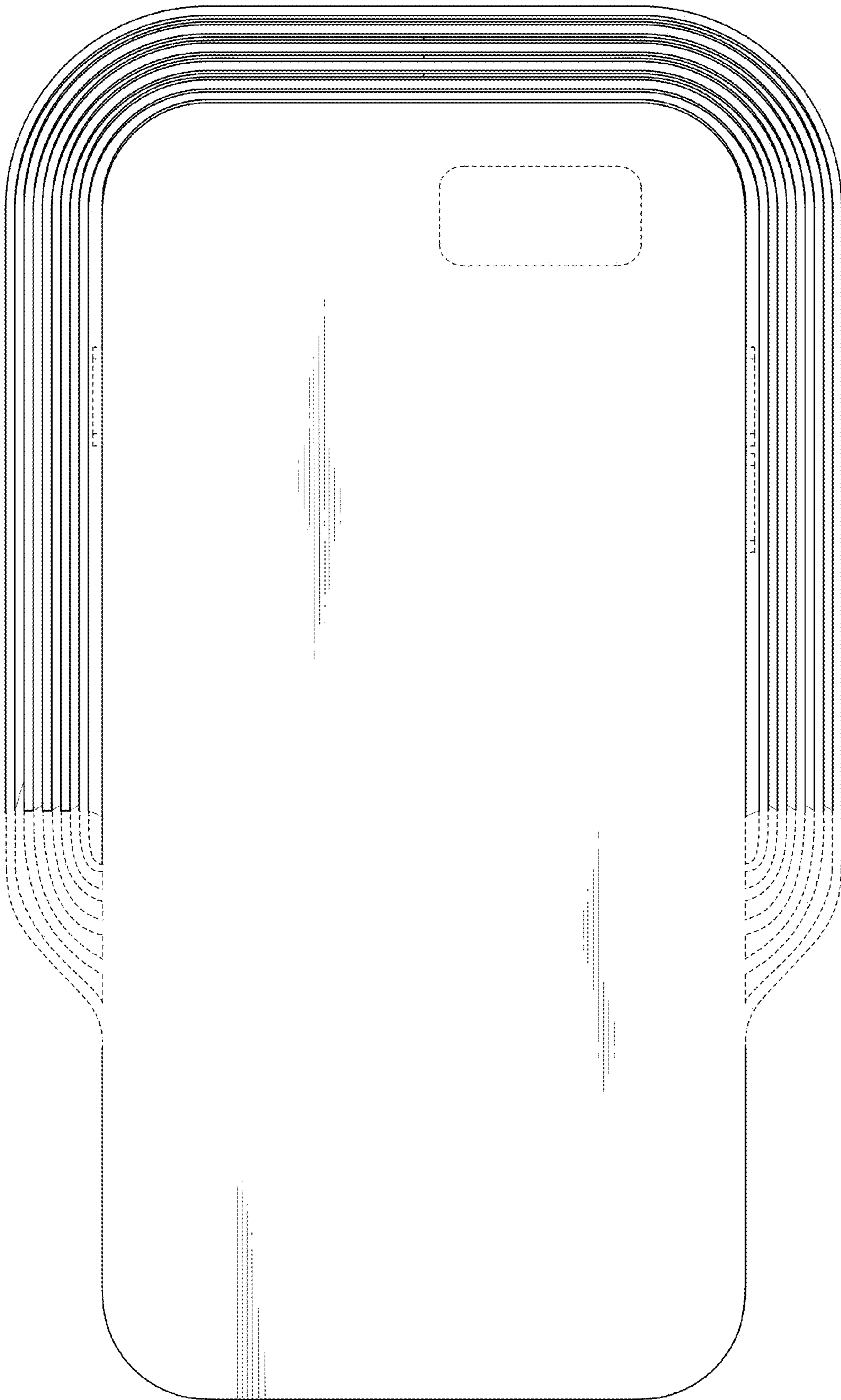

Fig. 5

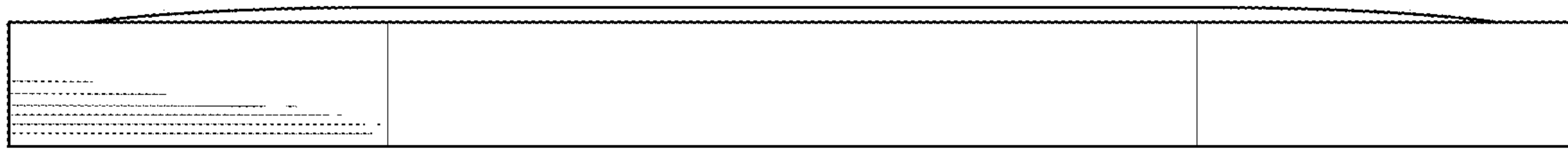

Fig. 6

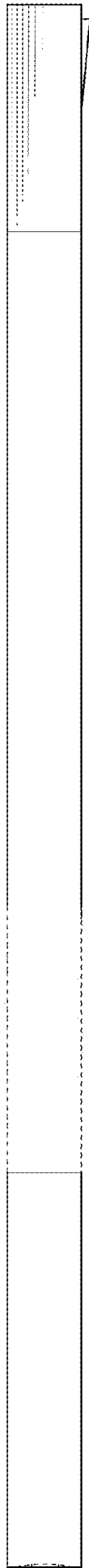

Fig. 7

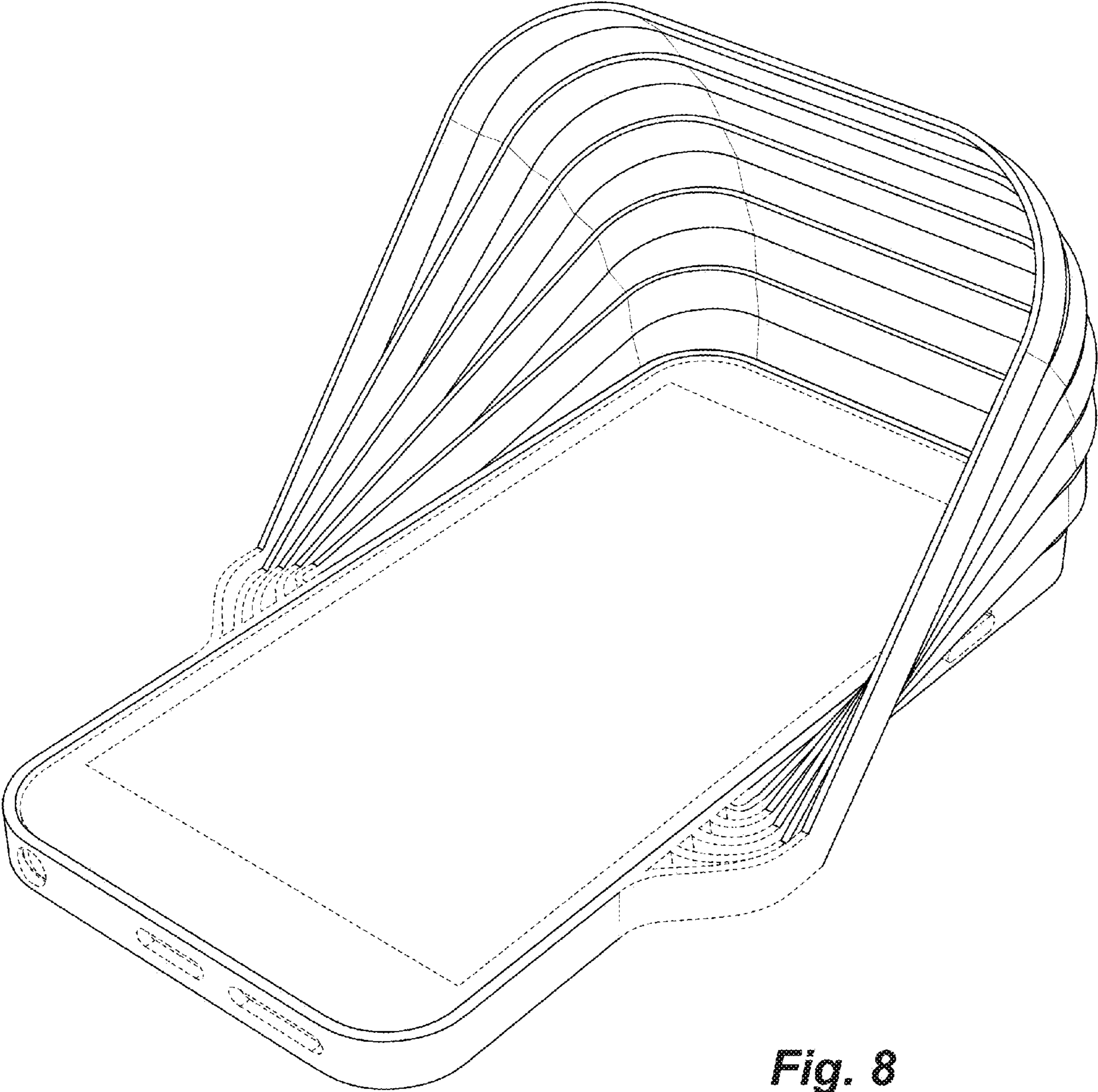

Fig. 8

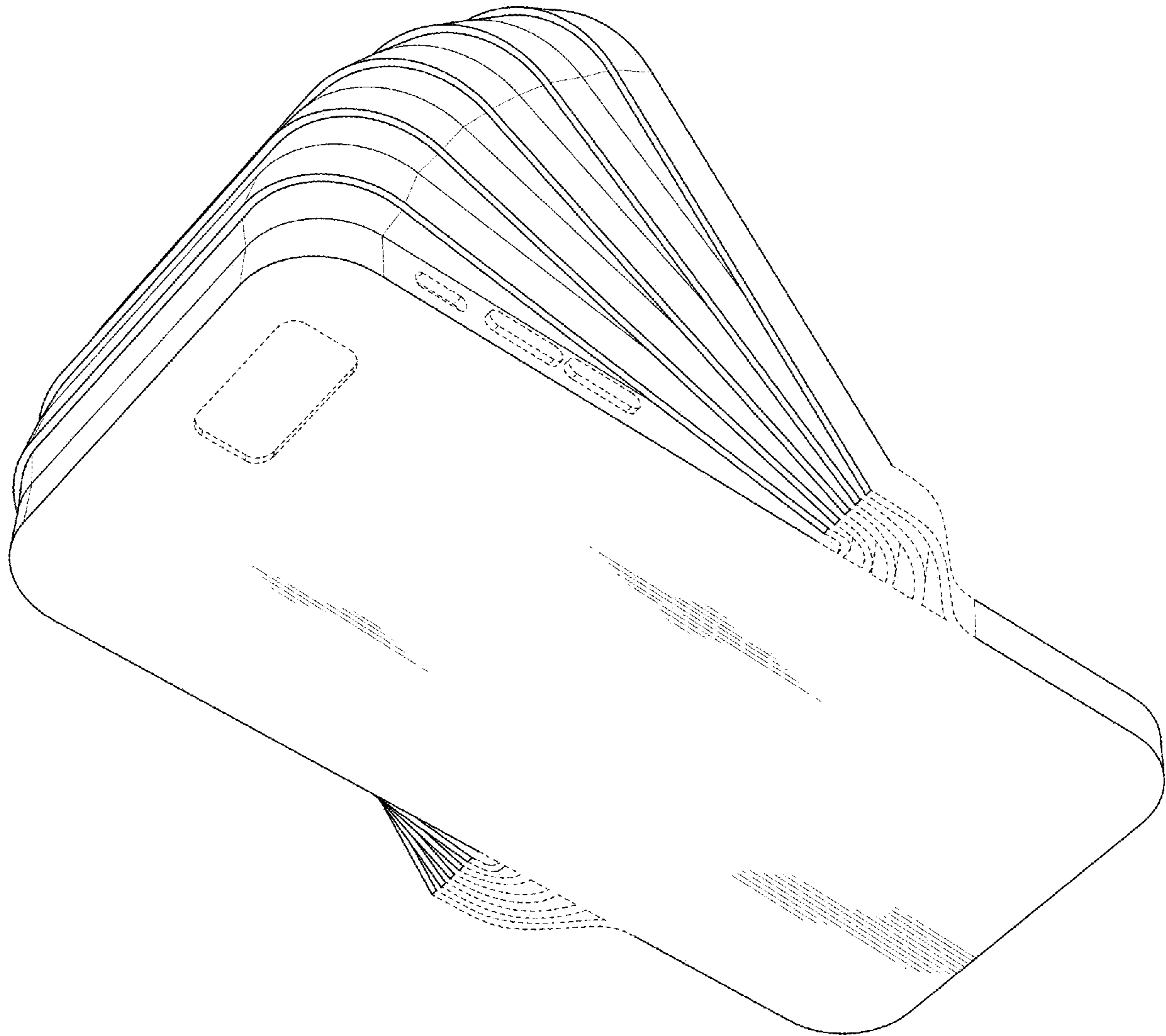

Fig. 9

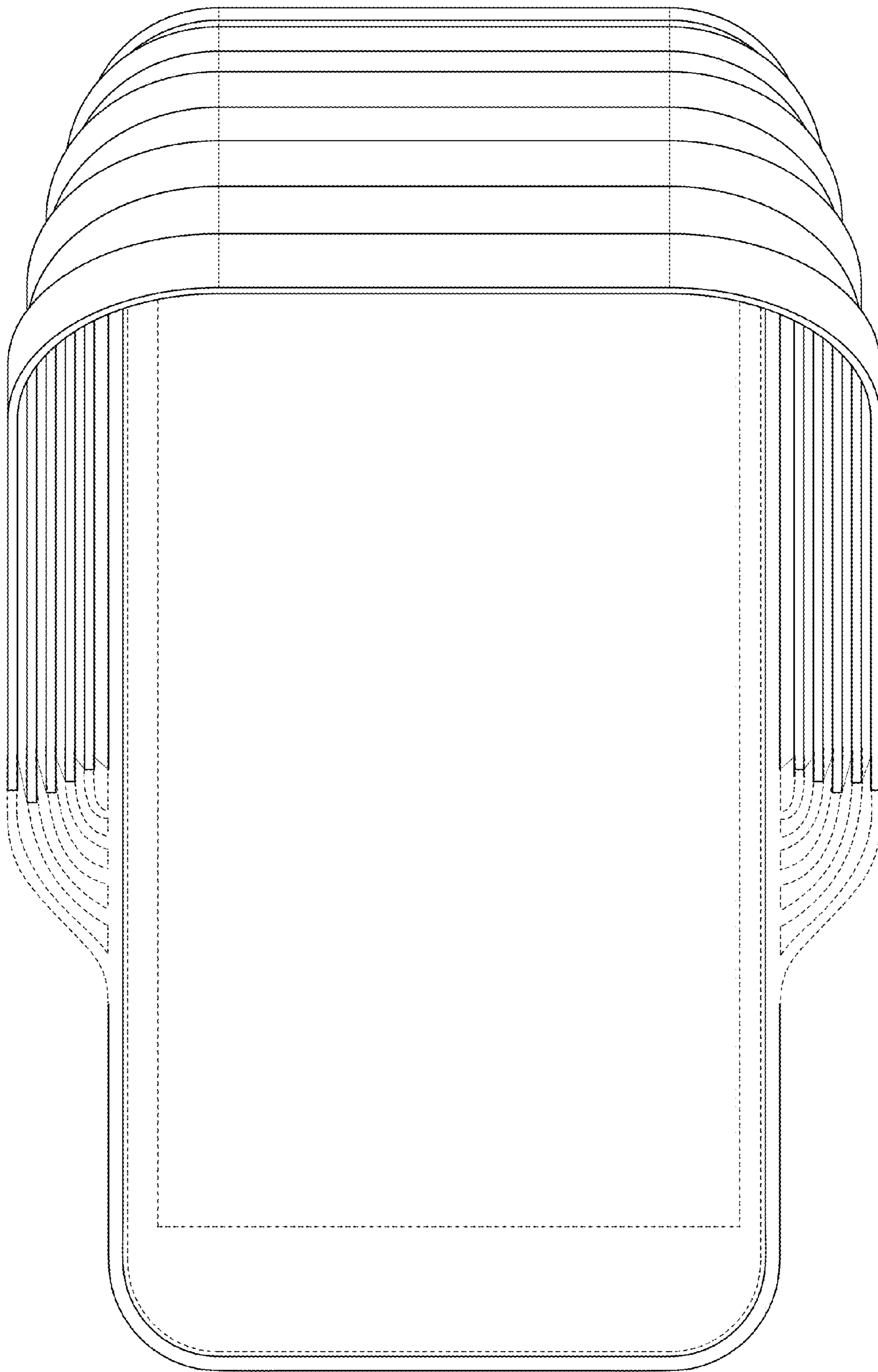

Fig. 10

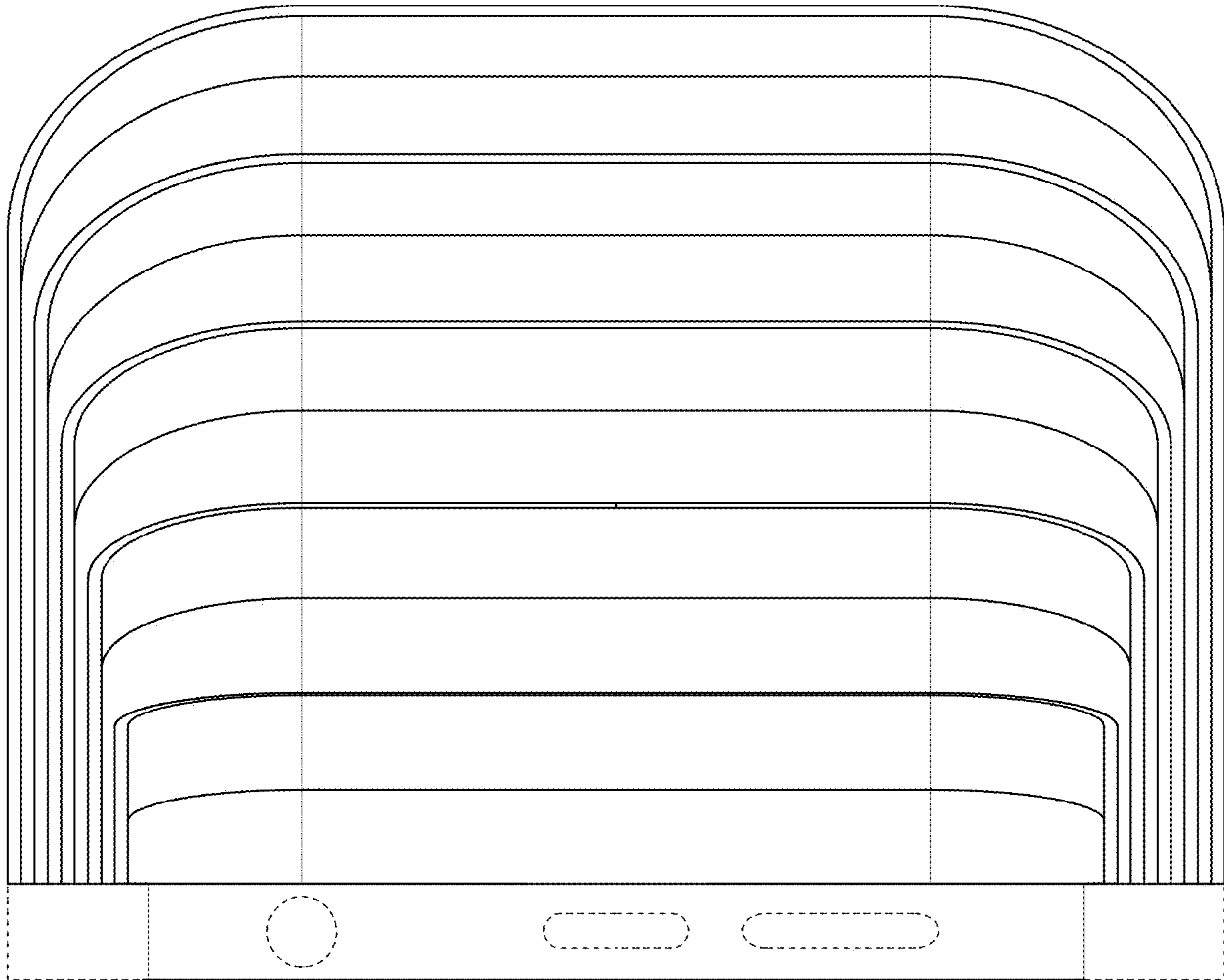

Fig. 11

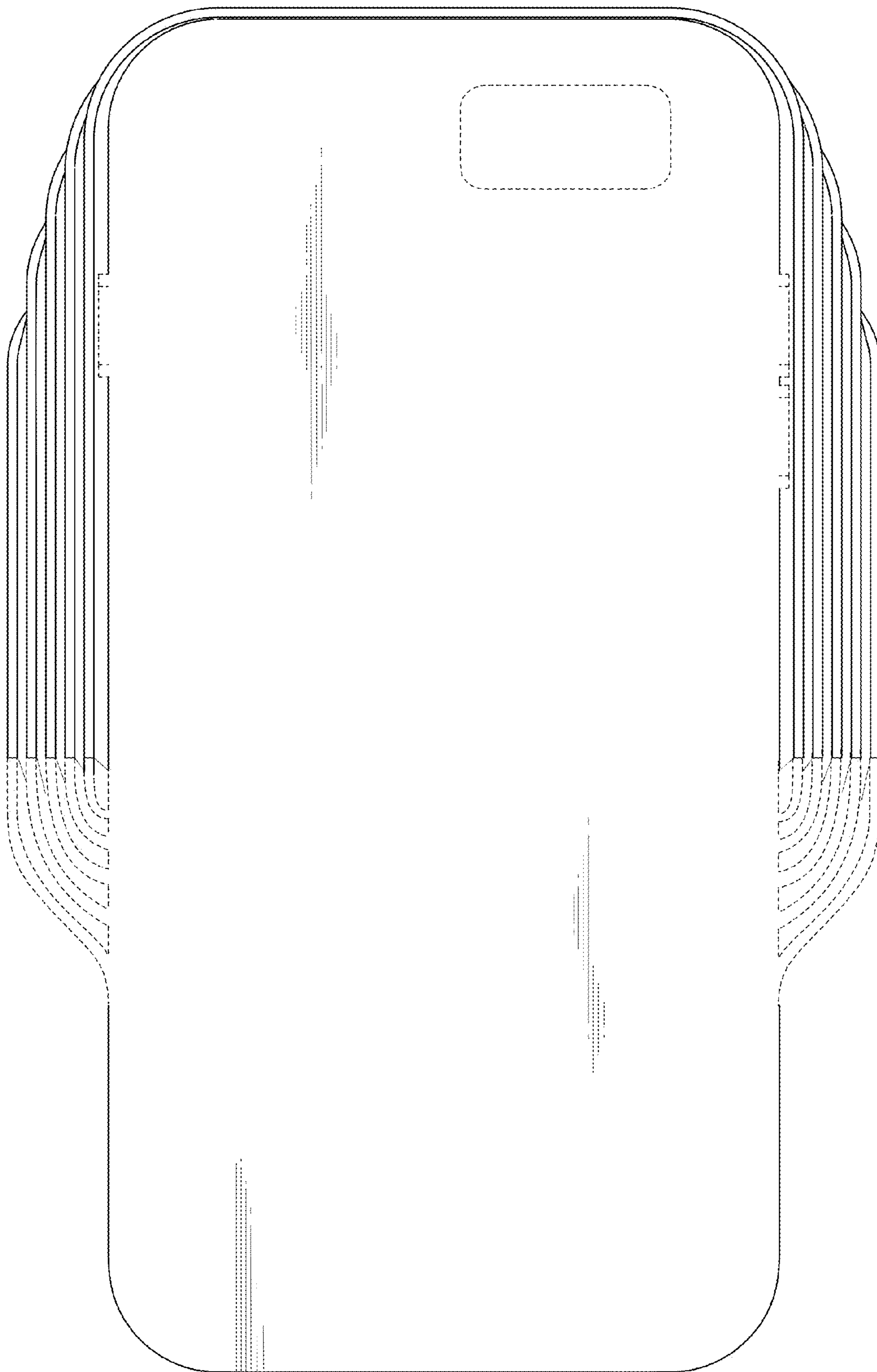

Fig. 12

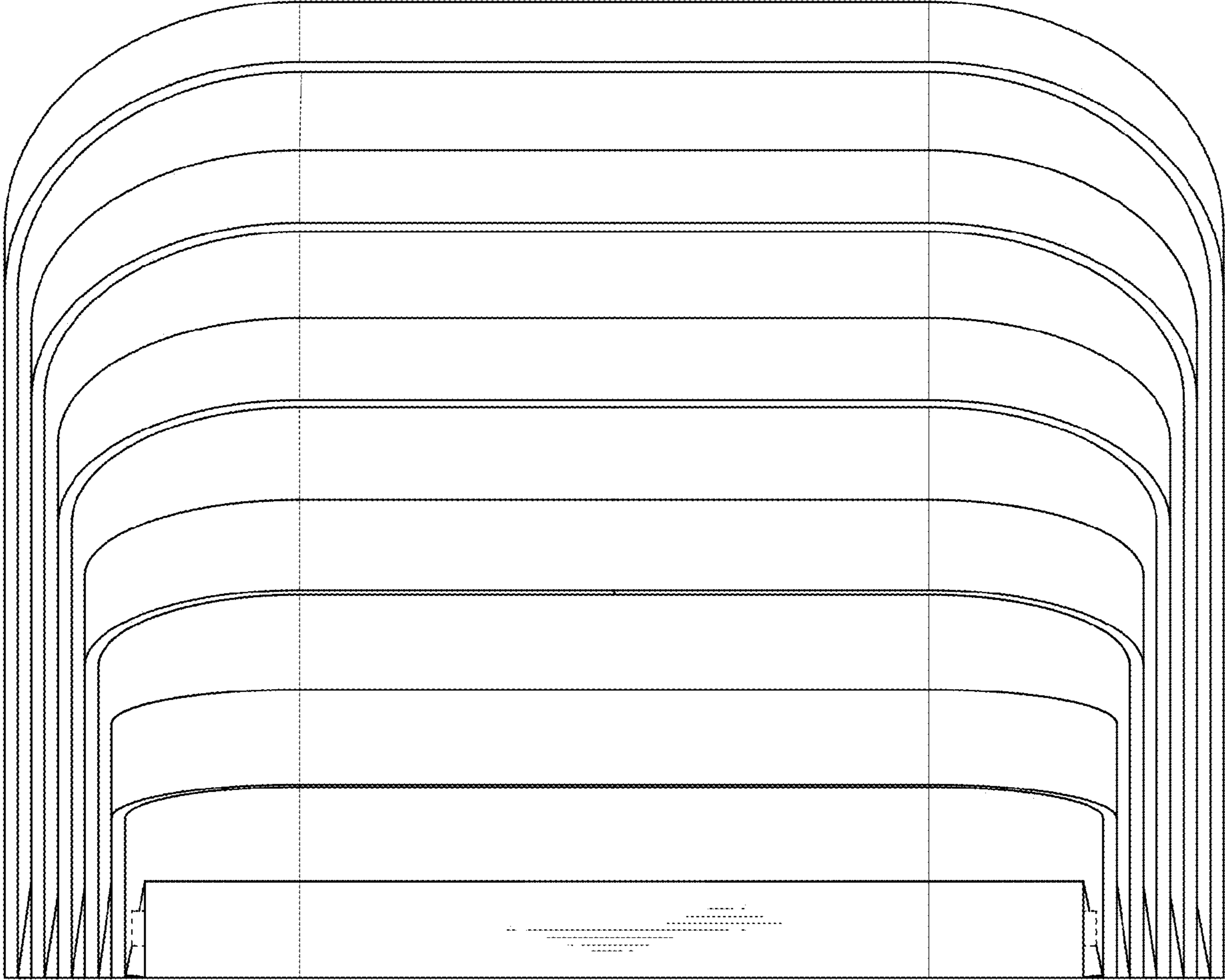

Fig. 13

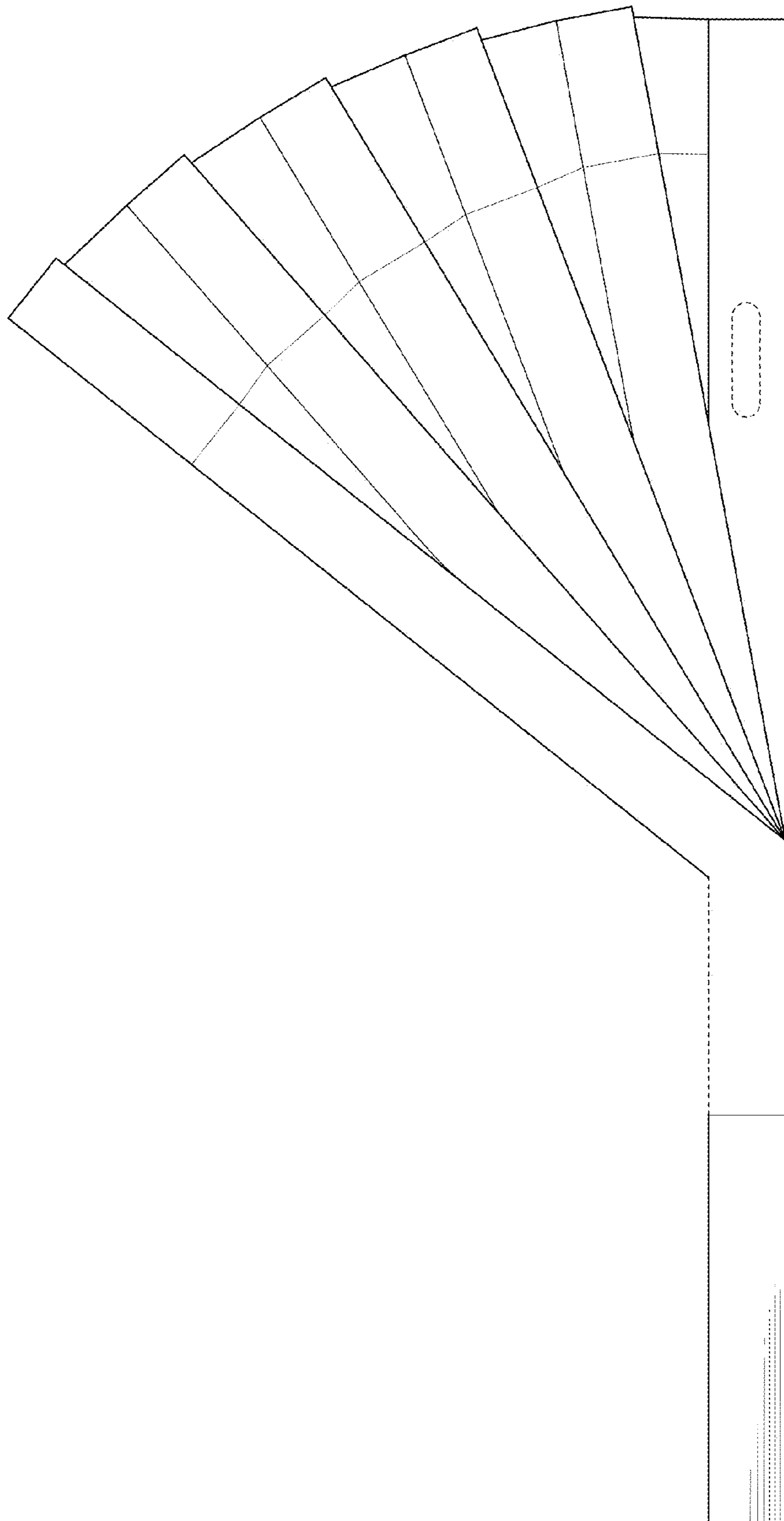

Fig. 14